



Smart A Endo Motor

INSTRUCTION MANUAL

Please read this manual before operating



GUILIN WOODPECKER MEDICAL INSTRUMENT CO., LTD.

Contents

1 Introduction.....	1
2 Installation and setting	6
3 Preparation and record	13
4 Apex Locator and record	16
5 Two in one and record.....	21
6 Root canals are not suitable for canal measurement	23
7 Trouble shooting	25
8 Cleaning, Disinfection and Sterilization	26
9 Storage, transport and maintenance	35
10 Environmental protection	36
11 After-sales service	36
12 Symbol instruction	36
13 Statement	37
14 EMC-Declaration of conformity	37

1 Introduction

1.1 Foreword

Thank you for purchasing the Smart A Endo Motor produced by Guilin Woodpecker Medical Instrument Co., Ltd. Woodpecker is a high-tech enterprise in researching, developing, producing and selling dental products. It owns a sound quality control system. To ensure that you use the equipment correctly and safely, please read the full text of the instruction manual carefully before use.

1.2 Introduction

Smart A is mainly used in endodontic treatment. It is a cordless endo motor with root canal measurement capability. It can be used as an endo motor for preparation and enlargement of root canals, or for measuring canal length. It can be used to enlarge the canals while monitoring the position of the file tip inside the canal.

Features:

- a) Cordless portable endo motor with combined length determination.
- b) Use efficient brushless motor.
- c) The magnetic adsorption charging base has a built-in high-capacity battery.
- d) The contra-angle can be rotated for 360°.
- e) Surface isolation of plastic contra-angle, built-in electrode of canal measurement.
- f) Adopt real-time feedback technology and dynamic torque control.
- g) The Motor handpiece can be connected to mobile smart devices through Bluetooth, which can realize APP control, voice control, and directly generate treatment reports and send them to your mailbox.
- h) The Motor handpiece can be connected to the Wireless foot pedal via bluetooth, and the Motor handpiece can be started/ stopped by the Wireless foot pedal.

1.3 Product configuration

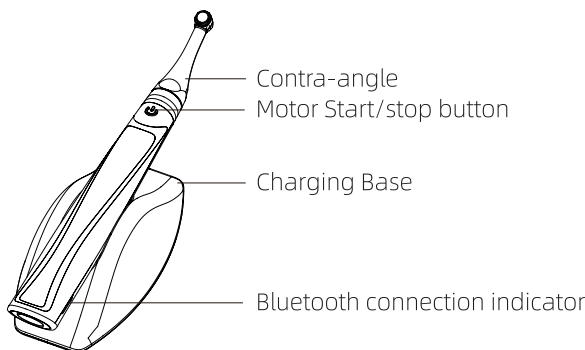

1.3.1 Structure

Smart A is composed of Motor handpiece, Contra-angle, Power adapter, Charging base, Wireless foot pedal, Measuring wire, File clip, Lip hook, Touch probe, Spray nozzle.

1. Motor handpiece is for root canal preparation and root canal length measurement;
2. Contra-angle has a 6:1 gear ratio, changes the output speed of the main unit; and has the function of holding a root canal file and driving its rotation.
3. Power adapter is only for charging;
4. Wireless foot pedal is only used to start or stop the motor;
5. Measuring wire, File clip, Lip hook and Touch probe are used for root canal length measurement.
6. Spray nozzle is used for oiling Contra-angle handpiece for maintenance.

1.3.2 Product accessories

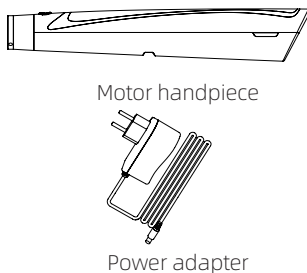
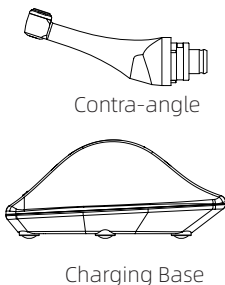

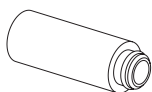

Nozzle



Tester



Measuring wire

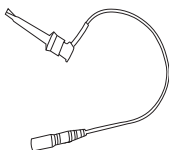

File clip



Touch probe



Lip hook



Disposable isolation sleeve



Wireless foot pedal (PF-2)



Protective silicon cover



Foot thimble

1.4 Indications for use

Smart A is a cordless endo motor with root canal measurement capability. It can be used as an endo motor for preparation and enlargement of root canals, or for measuring canal length. It can be used to enlarge the canals while monitoring the position of the file tip inside the canal.

1.5 Range of application

1.5.1 The device can be used for preparation and enlargement of root canals, or for measuring canal length.

1.5.2 The device must be operated in hospital and clinic by the qualified dentists.

1.6 Contraindications

In cases where a patient has been fitted with an implanted heart pacemaker (or other electrical equipment) and has been cautioned against the use of small electrical appliances (such as electric shavers, hair dryers, etc) it is recommended not to use the this device.

1.7 Device safety classification

1.7.1 Mode of operation: Continuous operating device

1.7.2 Type of protection against electric shock

(1) Base, motor handpiece and wireless foot pedal: Internally powered device

(2) Adapter: Class II

1.7.3 Degree of protection against electric shock: Type B applied part

1.7.4 Degree of protection against harmful ingress of water

(1) Base and motor handpiece: Ordinary equipment (IPX0)

(2) Wireless foot pedal: IPX1

1.7.5 Degree of safety application in the presence of a flammable anesthetic mixture with air, oxygen, or nitrous oxide: Equipment cannot be used in the presence of a flammable anesthetic mixture with air, oxygen, or nitrous oxide.

1.7.6 Applied part: contra-angle, lip hook, file clip, touch probe.

1.7.7 The contact duration of applied part: 1 to 10 minutes.

1.8 Primary technical specifications

1.8.1 Battery:

Base: built in two 3.6V/2000mAh Li-ion battery packs, and charge voltage is 5VDC, 1A.

Motor handpiece: built in a 3.7V/600mAh Li-ion battery pack.

Foot Pedal: built in a 3.6V/750mAh Li-ion battery pack.

1.8.2 Power adapter (Model: ADS-6AM-06N 05050xxx):

Input: ~100V-240V 50/60Hz 0.4A Max

Output: DC5V/1A

1.8.3 Torque range: 0.4Ncm~5.0Ncm (4mNm~50mNm)

1.8.4 Speed range: 100rpm~2500rpm

1.8.5 The contra-angle uses precision gear transmission inside, and the model is CA161 .

1.8.6 Charging of handpiece: DC 5V/1A

1.8.7 Software version: V1.0.0

1.8.8 Frequency range: BLE 2402-2480MHz

1.8.9 Maximum RF output power of the product:

(1) Handpiece: 1.81dBm

(2) Pedal: -1.45dBm

(3) BLE: 0.14dBm

1.9 Working environment

1.9.1 Environment temperature: +5°C~+35°C

1.9.2 Relative humidity: 30%~75%

1.9.3 Atmosphere pressure: 70kPa~106kPa

1.10 Warnings

- 1.10.1 Use the specified battery for this device. Never use any other batteries.
- 1.10.2 Do not expose the device to direct or indirect sources of heat. Operate and store the device in safe environment.
- 1.10.3 The device requires special precautions as regards electromagnet compatibility (EMC) and must be installed and commissioned in strict conformity with the EMC information provided in this instruction manual. Specifically, do not use the device close to fluorescent lamp, radio transmitters and remote controls.
- 1.10.4 The USB port of the base must only be connected to the original adapter ,the USB port of the handpiece could be connected to adater and measuring wire. Never use it for other purposes.
- 1.10.5 Over-heat scorching: the handpiece cannot be used for 10 minutes continuously.
- 1.10.6 If the handpiece works for 10 minutes continnously, the temperature of the surface of the handpiece and contra-angle may reach 47°C.
- 1.10.7 The adapter must be connected to an appropriate power source specified in 1.8.2.
- 1.10.8 Replacement of lithium batteries by inadequately trained personnel or incorrect replacement could result in a HAZARD,so please contact local distributors to replace the battery if necessary.
- 1.10.9 HAZARDS that may result from unauthorized modification of the device.
- 1.10.10 The device is not intended to be used in areas where liquids are likely to be present at floor level, such as emergency rooms or operating theatres.

Contra-angle

- Only use the original contra-angle. Do not use any other contra-angle or other reduction rate other than original one.
- 1.10.13 Never press the contra-angle push-button when the motor handpiece is running or if it is coming to a stop. This will lead to detachment of the instrument or cause the push-button to overheat.
- 1.10.14 Never remove the contra-angle from the motor handpiece during operation.
- 1.10.15 Only use undamaged root canal instruments. Please refer to the information provided by the manufacturer.
- 1.10.16 Only insert the instrument when the contra-angle is stationary.
- 1.10.17 Never place your fingers on the moving parts of the

instrument while it is running or coming to a stop.

1.10.18 Before treatment, check the contra-angle for any damage or loose parts.

Root canal instruments

1.10.19 Before use, make sure the instrument is securely locked in place.

1.10.20 Never use continuous rotary instruments in reciprocating mode.

1.10.21 Never use reciprocating instruments in rotary mode.

1.10.22 Use the torque and speed settings recommended by the instrument manufacturer.

1.11 Caution

1.11.1 The device must only be used in suitable locations and only by specialized physicians licensed to practice dentistry.

1.11.2 Long time use of the device will lead to overheating of the micro motor, let it cool down before using. If the motor handpiece still overheats, contact your distributor.

1.11.3 The device cannot be used on the patient during maintenance or service.

1.11.4 When working with an adapter, you must place the adapter where it is easy to disconnect from the supply mains.

2 Installation and setting

2.1 Bluetooth connection

If you need to set the parameters to operate the handpiece, you must establish a Bluetooth connection between the APP and the handpiece.

The Bluetooth connection indicator has four states:

Bluetooth connection indicator	Identification meaning
Turn Yellow	Mobile device is connected
Turn Blue	Foot pedal is connected
Turn Purple	Mobile device and Foot pedal are connected
Turn off	No mobile devices are connected

2.2 Installing and removing the contra-angle

2.2.1 Installing

Align any locating pin of the contra-angle with the positioning slot on the motor handpiece and push the contra-angle horizontally. The three locating pins on the contra-angle are inserted into those three positioning holes on the motor handpiece. A “click” sound indicates that the installation is in place. The contra-angle can be

rotated 360° freely.

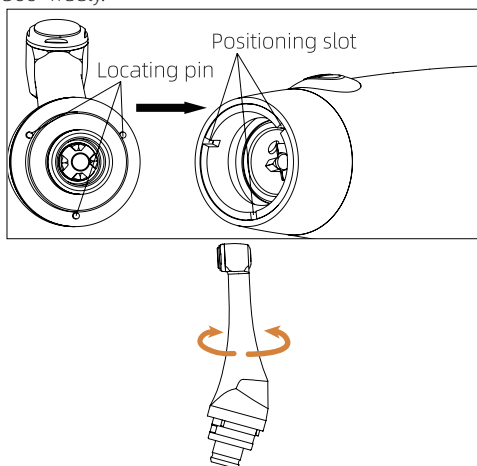

The contra-angle is free to rotate, adapting to the root canal of different positions, and it is convenient to watch the screen when operating.

2.2.2 Removing

When removing the contra-angle, pull it straight out.

When inserting and removing the contra-angle, turn the motor handpiece power off beforehand.

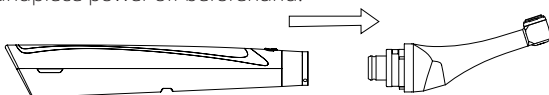

2.3 Inserting and removing the file

2.3.1 Installing

Insert the file into the chuck until it stops.

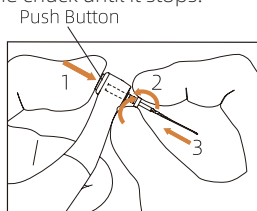

Press the back cover

2.3.2 Removing

Press the push-button and pull out the file.
When inserting and removing the file, turn the motor handpiece power off beforehand.

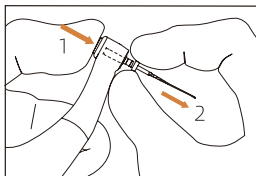

2.5 WEndo App Operation Instructions

WEndo is a multi-user IOS and Android application for iPad and mobile iphone which includes the following features:

- Treatment log
 - File system
 - User profile management
 - Motor handpiece management via the Bluetooth connection to the device.
 - Voice control to adjust equipment parameters. The application is available in the App Store or App Market.
- Application updates are also available in the App Store or App Market.

Click on the  to start the app.

For detailed usage of WEndo ® App, please read the instruction manual of WEndo ® App.

How to get the WEndo app operating instructions

To obtain it through the official website, the specific steps are as follows:

1. Click the link: www.glwoodpecker.com. Or scan the QR code. Click the WOODPECKER logo to enter.
2. Select "User Services-Download".
3. Select Endo Motor in "Download", find the WEndo app manual in this download list, and select the WEndo app manual for the corresponding platform to preview online or download.



2.6 Motor Handpiece

2.6.1 Description of the Motor Handpiece

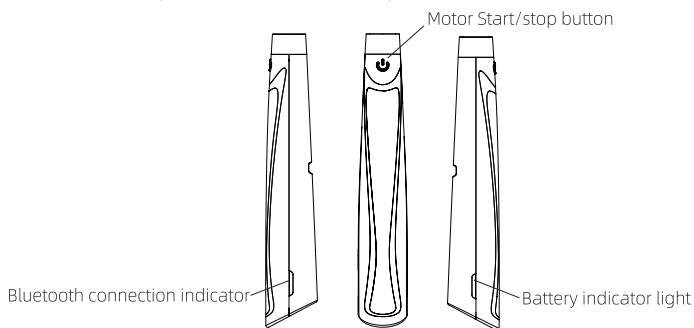

2.6.2 Description of the LED Colors

Button/LED	State	Description
Motor START/ STOP button	/	<ol style="list-style-type: none"> 1.Press the button to start the motor handpiece; 2.Press again to start the motor handpiece; 3. Press the button again to stop the motor handpiece; 4.Long press to power off the motor handpiece.
Motor START/ STOP button	The motor control button indicator light is always on blue	The motor is in standby
	The motor control button indicator light flashes green.	The motor is running, and the current torque of the file is less than 50% of the set torque
	The motor control button indicator light flashes yellow.	The motor is running, and the current torque of the file is higher than or equal to 50% of the set torque and less than 75% of the set torque.
	The motor control button indicator light flashes purple.	The motor is running, and the current torque of the file is higher than or equal to 75% of the set torque.

Bluetooth

	(1)Handpiece	
	The indicator light on the right side of the handpiece flashes blue.	Bluetooth is on, the motor handpiece Bluetooth is searching for a Wireless foot pedal to connect to.
	The indicator light on the right side of the handpiece is yellowish green.	The motor handpiece is connected to the App.
	The indicator light on the right side of the handpiece is blue.	The motor handpiece is connected to the foot pedal.
	The indicator light on the right side of the handpiece is purple.	The motor handpiece is connected to the App and the foot pedal.
	(2)Foot Pedal	
	The Bluetooth indicator (left) on foot pedal is flashing blue.	The foot pedal is searching for Bluetooth devices.
	The Bluetooth indicator(left) is always blue.	The foot pedal is communicating with handpiece.

Battery

	(1)Handpiece	
	The indicator light on the left side of the handpiece is green.	The device is fully charged , or the battery content is more than 20%
	The left indicator light of the handpiece is yellow.	Low battery level. Connect the motor handpiece to the adapter.
	The left indicator light of the handpiece is flashing green.	The handpiece is charging.
	(2)Foot Pedal	
	The indicator light(right) on foot pedal is green.	The foot pedal is on or fully charged.
	The indicator light(right) on foot pedal is yellow.	Low battery level.
	The indicator light(right) on foot pedal is flashing green.	The foot pedal is charging.
	(3)Base	
	The indicator light on base is yellow.	The base is charging.
The indicator light on base is green.	The device is fully charged.	

2.7 Wireless foot pedal

Warnings:

- Before connecting to Wireless foot pedal, make sure the handpiece and the Wireless foot pedal are fully charged.

2.7.1 Description of Wireless foot pedal

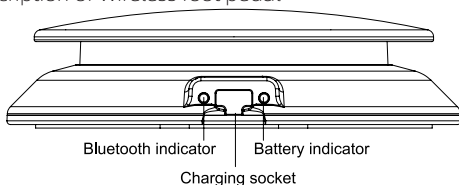

2.7.2 Activate the Wireless foot pedal

After the Wireless foot pedal is used for the first time or placed for a long time, you need to press the Wireless foot pedal for 3 seconds to activate it. When the Bluetooth indicator or Battery indicator of the Wireless foot pedal is on, it means that the Wireless foot pedal is activated successfully.

Note:

- When activating the Wireless foot pedal, please step on the middle of the top of the wireless control pedal for 3 seconds.
- If the Wireless foot pedal cannot be activated, it may be that the Wireless foot pedal is out of power. Please fully charge the Wireless foot pedal before proceeding.
- After the Wireless foot pedal is activated, if it is not operated for 5 minutes, the Wireless foot pedal will automatically shut down.

2.7.3 Wireless connection of Wireless foot pedal

- Ensure that the Wireless foot pedal has enough power and turned on by press the top surface of Wireless foot pedal, the Bluetooth indicator will continue to flash, at this time, if the handpiece is turned on, the Bluetooth will be paired automatically.
- Bluetooth indicator will be on and stop flashing while the handpiece and the Wireless foot pedal are connected successfully. If the connection fails, the Bluetooth indicator will keep flashing.

2.7.4 Operating of Wireless foot pedal

- After ensuring that the Wireless foot pedal is connected successfully, step on the Wireless foot pedal to control the start/stop of the handpiece.

2.7.5 Re-pair wireless foot pedal

When the wireless foot pedal cannot be connected to the handpiece or the wireless pedal needs to be replaced, you need to re-pair the handpiece with Bluetooth. The operation steps are:

1. Press and hold the motor start/stop button when the handpiece is turned off until the bluetooth indicator flashes blue and release the button.
2. Press the pedal to power it on. At this time, the Bluetooth indicator of the pedal flashes blue.

3. Use a thin needle to long press the button with the wireless logo on the pedal shown in the figure below.
4. The Bluetooth indicator of the handpiece is always on, and the Bluetooth pairing is successful.

2.7.6 Power off the wireless foot pedal

The wireless foot pedal can automatically shut down after 5 minutes of inactivity. Or you can also use a thin needle to long press the button with “S” shown in the figure below to force the shutdown.

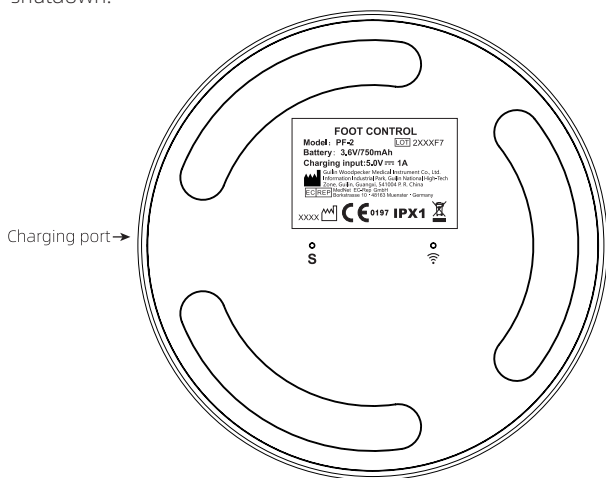

2.8 Installation and removal of disposable isolation sleeves

2.8.1 Installation

Before each use of the handpiece and after the handpiece is cleaned

and disinfected, put on a disposable isolation sleeve. Take the isolation sleeve out of the isolation sleeve box, then insert it into the motor handpiece from the thin end of the handpiece, until there is no obvious wrinkle.

After installing the disposable isolation sleeve, wrap the barrier film around the handpiece surface. After that, clean and disinfect the surface of the handpiece. Refer to Chapter 6.3 for cleaning and disinfection procedures.14.

2.8.2 Removing

After each use, remove the barrier film and slowly pull the isolation

sleeve from the thin end of the handpiece.
Warning: Isolation sleeves are not reusable.

3 Preparation and record

3.1 Starting and stop of motor handpiece

3.1.1 When the motor handpiece is standby, press the START/STOP button or step on the wireless foot pedal, the motor will start.

3.1.2 When the motor handpiece is on, press the START/STOP button or release the wireless foot pedal, the handpiece will stop. (Except for Ledge Bypass mode, in Ledge Bypass mode, press the foot motor for the first time to enter the first movement mode, release the foot motor to enter the second movement mode, press and release again, the motor stops.)

3.1.3 After the App is started, in the power-on state of handpiece, if the App wireless communication connection icon is lit, the motor handpiece has established wireless communication with the App. When the START/STOP button is pressed, the motor handpiece will enter the working state according to the current mode set in the App.

3.1.4 The handpiece will automatically shut down after ten minutes of inoperation or can be shut down via APP.

3.2 Auto reversing protection mode

3.2.1 AUTO REVERSING

During operation, if the load exceeds the preset value, the file rotation mode automatically becomes reverse mode. When the load falls below the preset value again, the file returns to forward mode.

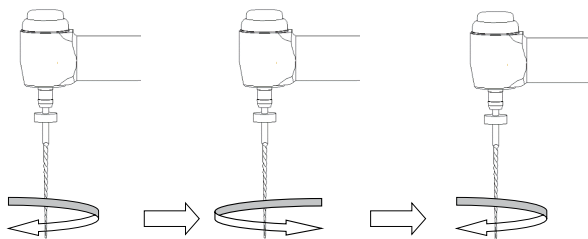

Load value is lower than preset torque value

Load value is higher than preset torque value

Load value is lower than preset torque value again

Clockwise rotation

Counterclockwise rotation

Counterclockwise rotation

1.AUTO REVERSING mode is only effective in continuous forward rotation mode.

2. The motor handpiece battery percentage can be displayed on the WEndo App interface. When the battery power is lower than 20%, it is not enough to support the motor handpiece to reach the limit torque value, that is, the automatic reverse function will not work properly, please use the original adapter or charging base in time. Recharge, so as not to delay use.

3. If the motor handpiece is always under load, the machine may automatically stop due to overheating protection. If this happens, turn off the motor handpiece for a period of time until the temperature of the motor handpiece drops before use.

3.3 The display of the torque

The torque value at work will be displayed on the APP interface in real time.

3.4 File system

Note: The following operations must be performed when the motor handpiece is in the ready state. When the motor handpiece is in the working state (the motor is running), the WEndo App selection button will be locked, and the following operations cannot be completed.

Users can choose different file systems to use in the File System on the app. Different file systems have different parameters and modes.

3.4.1 Continuous mode

The user can select the file system on the WEndo App for treatment. When the selected file system is continuous mode. The motor handpiece rotates forward 360°, clockwise direction.

3.4.2 Reciprocating mode

There are reciprocating filing system parameters in WEndo App, and you can switch to the reciprocating filing system by selecting "File System". At this time, the name of the reciprocating system and the model of the file are displayed on the App interface.

3.4.3 ATR mode

In this mode, when the load of the file is higher than the set torque limit, the file will start to rotate alternately at the set angle.

3.4.4 BB mode (BB: block bypass)

After starting the handpiece, the handpiece first rotates once in the forward direction, then stops for 1S, and then continues to rotate once in this cycle.

3.4.5 LB mode (LB: ledge bypass)

In LB mode , press the power button of the handpiece for the first time, the handpiece will reciprocate, press the power button of the handpiece for the second time, the handpiece will run continuously, and press the power button of the handpiece for

the third time. , the handpiece will stop running. The LB mode treatment page is shown below.

3.5 Change the speed and torque

When desired continuous rotary file is selected, press Speed '+/-' button to select the desired speed setting, the speed range is 1000-2500rpm.

Press the Torque '+/-' button to select the desired torque setting, torque range: 0.4-5.0Ncm.

3.6 Calibration

This function is to decrease fluctuation in the rotation speed of the motor handpiece and the difference in torque by the contra-angle. Calibration is recommended when using a new/other contra-angle or after an extended period of operation (At least once a month), as the running properties can change with usage, cleaning and sterilization.

a. Install the contra-angle to the motor handpiece.

b. Touch the "CAL" button of APP to select the Start treatment mode.

c. Press the "Start/Stop" button to calibrate.

d. Calibration lasts 5 seconds.

e. Activate the motor handpiece, and the motor handpiece will accelerate from the minimum speed to the maximum speed to automatically measure the inertia and no-load resistance of the contra-angle.

3.7 Battery charging

3.7.1 Base charging

The base has a built-in energy storage lithium battery.

When the base is in charging, the indicator light turns orange, the light will turn green when the battery is full.

After charging, pull out the power adapter.

3.7.2 Motor handpiece charging

There are two charging methods:

Method 1:

The motor handpiece has a built-in energy storage lithium battery and is equipped with contact charging.

Put the motor handpiece correctly in the motor handpiece groove of the base. The green light on the left side of handpiece flashes when charging. When the motor handpiece is fully charged, the charging indicator light will turn green.

Method 2:

Plug the original power adapter into the TYPE C USB connector at the bottom of handpiece. In this mode, it can work while charging

3.7.3 Wireless foot pedal charging

When the battery is full, the light on the wireless foot pedal is off; when the battery is insufficient, the indicator light on the pedal displays orange, to prompt the user to charge.

! The original power adapter is highly recommended, If you need to use another adapter, please charge it in the off state.

! **WARNING**

- a. Do not open the device or replace the battery . This may cause a short circuit.
- b. If there is a battery leakage, please stop using immediately, and deliver the machine to the authorized service center for repairing.
- c. Please do not use other USB cable to charg, otherwise it will cause damage to the machine.

4 Apex Locator and record

4.1 Insert the measuring wire

4.1.1 Insert measuring wire into bottom of handpiece. (as shown in the picture)

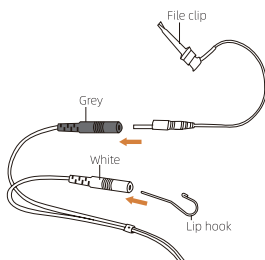

Picture 1

Attention:

a. Please be careful to use the device, keep it stable and avoid hit. Incautious use will lead to the damage or the failure of the machine.

b. Measurement cannot be proceeded without the complete insertion of the plug.

c. Be sure not to hit the plug. Keep the device away.

4.1.2 Insert the file clip and lip hook respectively into the two sockets of the measuring wire.

Make sure the file clip is plugged into the gray port and the hook is plugged into the white port [Picture 1]

Attention:

Be sure not to pull the wire when inserting or pulling out the measuring wire and the file clip. [Picture 2(a)]

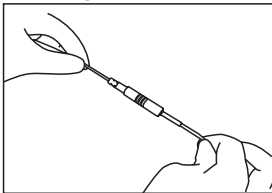

Picture 2(a)

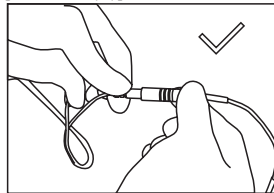

Picture 2(b)

Correct operation is shown in picture 2(b).

4.2 Test the wire connection (Test before each use)

a. After the device has been successfully connected, click on "Apex locator and record" on the device page to enter the mode selection page.

b. Select "Apex locator and record" to enter the "Start measuring and record" page.

c. Make sure the plug of the measuring wire is inserted into the socket correctly.

d. Make sure the file clip and lip hook are connected well to the measuring wire.

e. Make the lip hook touch the bent wire of the file clip [as shown in picture 3] to confirm all the instruction bars are displayed on the APP interface and stably display the digital '-3', otherwise, it means that the file clip or the measuring wire is damaged, should be replaced.

Note: When testing the wire connection, the handpiece cannot be placed on the base.

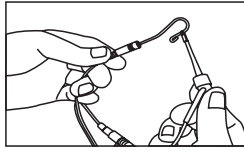

Picture 3

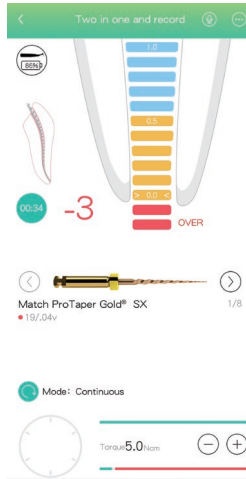

Picture 4(a)

4.3 Testing the device by tester (Test every two weeks)

Users can use the tester to check if the device works properly, specific operation is as follows:

a) Pulling out the measuring wire and turn off the device.

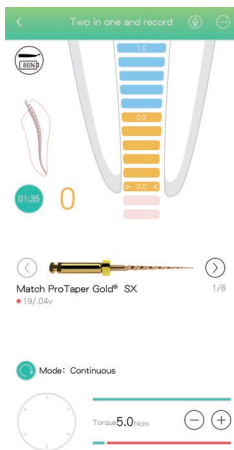

Picture 4(b)

b) Insert the tester.

c) After powered on, if the indicating bar indicates within ± 1 bars away from the dial 0.0 the device functions normally [Picture 4(b)]. If the indicating bar is outside the range, the device cannot measure accurately. On this occasion, please contact authorized distributor or manufacturer for help.

4.4 Determine the working length

a) When the indicating bar reaches the position of the dial 0.0 [Picture 4(b)], and there is "APEX" on screen, the endo file has reached the anatomical apical foramen. On the basis of measured length, subtract 0.5-1.0 mm to get the working length.

b) When the indicating bar reaches the red area "OVER" [Picture 4(a)], it indicates that the endo file has exceeded the apical foramen.

4.5 Operation instruction

4.5.1 Please let the measure wire insert the handpiece. Then start up the power button. Next select the start measuring. And you can enter into the apex locator mode.

4.5.2 After the device is started up, you can press the power button again to turn it off.

4.5.3 If you click the "Device volume", you can turn up the voice.

4.5.4 Hang the lip hook on the lip, make sure it contact the oral mucosa as a reference electrode [Picture 5].

4.5.5 Clip the file with file clip, move the file towards the apex, then

there will be continuous alarm when the distance is less than 2mm [Picture 6].

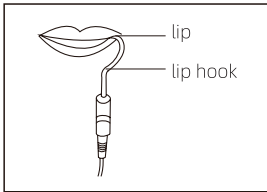

Picture 5

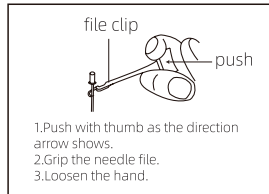

Picture 6

Attention:

a. When gripping the root canal with a needle file, please grip the upper of the metal part (near the root canal at the needle handle). If you grip the lower part (blade or moving part), it will wear the metal part of the file folder and the resin part. [Picture 7]

b. When measuring the length of root canal, please don't use the metal needle file.

If you operate the device without the dentistry glove, it will cause leakage and the result of measurement will be inaccurate. Therefore, please use the resin needle file and remember don't touch the metal part with finger.

c. Please don't use the worn file clip, and it will make the result of measurement inaccurate.

d. Please reference the [Picture 8(a)] to grip the needle file. If as [Picture 8(b)], it can't.

4.5.6 When the file refer to the apex, adjust the rubber piece set on the endo file to the reference point (incision edge or fossa edge), then pull out the endo file, measure the length between the top of the file and the rubber piece, and this is the working length of the tooth. It also can be used with the touch probe instead of file clip, when it is inconvenient to measure the back teeth. [Picture 9]

4.6 The components that touch body must be autoclaved under high temperature and high pressure. The shell and measuring wire should be cleaned by 75% alcohol.

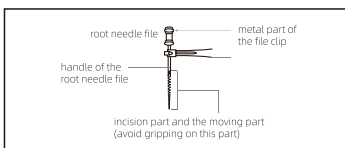

Picture 7

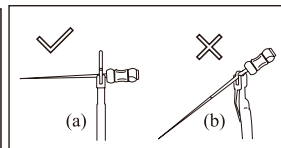

Picture 8(a)

Picture 8(b)

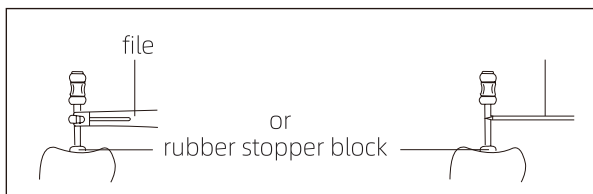

Picture 9

5 Two in one and record

5.1 Installation of measuring wire

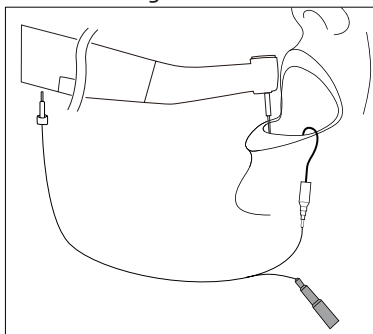

When using motor combined canal measurement function, the measuring wire must be connected with motor handpiece by measuring wire. The white socket is connected with the patient's lip via lip hook, and the gray socket remains idle.

The canal length indicator bar will show on the screen. (More information about canal length indicator bar, please see APP Manual).

Setting parameters of automatic functions as needed, such as Apical Action, Auto Start, etc. (More information about automatic functions, please see APP Manual).

5.2 APP setting

5.2.1 Click the "Two in one and record" to select the Motor combined canal measurement function mode.

5.2.2 Select file system.

5.2.3 Motor combined canal pmeasurement function mode

parameter setting.

5.2.4 Connection testing (Test every time before using): touch the file with the lip hook, if "-3" is displayed, it works well, otherwise, the USB wire or measuring wire should be replaced.

5.2.5 Parameter setting

a) Apical Action :Actions that happen automatically when the file tip reaches the point inside the canal determined by the Flash Bar setting.

Benefitting from integration of length determination,when the file reaches the reference point, the motor will respond according to setting, it can be Reverse , Stop and OFF.

Parameters can be set on the corresponding page of the WEndo app.

OFF: The file rotates as usual even if it reaches the reference point.

Stop: The file stops automatically when it reaches the reference point, and continues rotation when it is lifted up a little.

Reverse: The file reverses automatically when it reaches or exceeds the reference point, and restores the original rotation direction again when it is lifted up a little.

b) Auto Start :Rotation starts automatically when the file is inserted into the canal and the canal length indicator bar lights up more than 2 bars.

OFF: Motor does not start when file is inserted into the canal. The Main button is used to start and stop the motor handpiece.

ON: Motor starts automatically

c) Auto Stop:Rotation stops automatically when the file is taken out of the canal and the canal length indicator bar lights up less than 2 bars before the file is taken out.

OFF: Motor does not stop when file is taken out of the canal. The Main button is used to start and stop the motor handpiece.

ON: Motor stops automatically.

d) Apical Slow Down:Rotation automatically slows down as the file tip approaches the reference point.

OFF: Disable Apical Slow Down function.

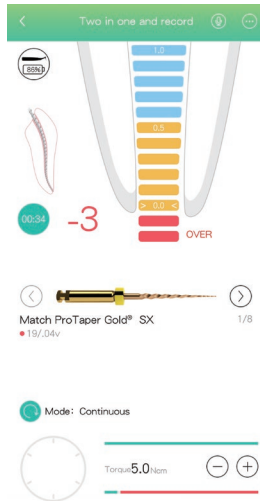

ON: Rotation automatically slows down as the file tip approaches the reference point.

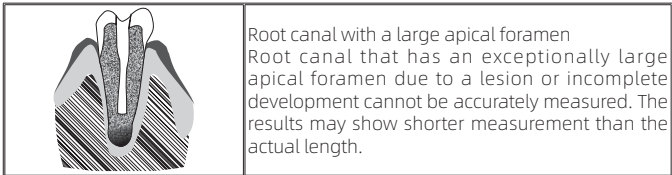

6 Root canals are not suitable for canal measurement

Accurate measurement cannot be obtained if the root canal conditions are shown as below.

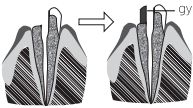
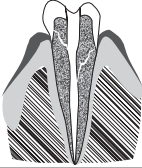

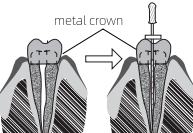
	<p>Root canal with blood overflowing from the opening</p> <p>If blood overflows from the opening of the root canal and contacts the gums, this will result in electrical leakage and an accurate measurement cannot be obtained. Wait for bleeding to stop completely. Clean the inside and opening of the canal thoroughly to get rid of all blood, and then make a measurement.</p> <p>Root canal with a chemical solution overflowing from the opening</p> <p>An accurate measurement cannot be obtained if some chemical solution is overflowing from the canal opening. In this case, clean the canal and its opening.</p> <p>It is important to get rid of any solution overflowing from the opening.</p>
	<p>Broken crown</p> <p>If the crown is broken and a section of the gingival tissue intrudes into the cavity surrounding the canal opening, contact between the gingival tissue and the file will result in electrical leakage and an accurate measurement cannot be obtained. In this case, build up the tooth with a suitable material to insulate the gingival tissue.</p>
	<p>Fractured tooth</p> <p>Leakage through a branch canal</p> <p>Fractured tooth will cause electrical leakage and an accurate measurement cannot be obtained. A branch canal will also cause electrical leakage.</p>
	<p>Re-treatment of a root filled with gutta-percha</p> <p>The gutta-percha must be completely removed to eliminate its insulating effect. After removing the gutta-percha, pass a small file all the way through the apical foramen and then put a little saline in the canal, but do not let it overflow from the canal opening.</p>
	<p>Crown or metal prosthesis touching gingival tissue</p> <p>Accurate measurement cannot be obtained if the file touches a metal prosthesis that is touching gingival tissue. In this case, widen the opening at the top of the crown so that the file will not touch the metal prosthesis before taking a measurement.</p>



Too dry

Extremely dry canal

If the canal is extremely dry, the meter may not move until it is quite close to the apex. In this case, try moistening the canal with saline.

Different measuring result between apex locator reading and radiography
Sometimes the reading of apex locator and the X-ray image will not correspond. This does not mean that the apex locator is not working properly or that the X-ray exposure is a failure. An X-ray image might not show the apex correctly depending on the angle of the X-ray beam, and the location of the apex might seem to be other than it really is.

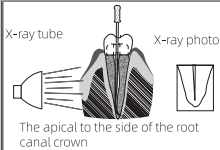

The actual apex for the canal is not the same as that for the anatomical apex. There are frequently cases where the apical foramen is located up towards the crown. In these cases, an X-ray might indicate that the file has not reached the apex even though it has actually reached the apical foramen.

7 Trouble shooting

When trouble is found, check the following points before contacting your distributor. If none of these are applicable or the trouble is not remedied even after action has been taken, the product may have failed. Contact your distributor.

Problem	Cause	Solution
After the motor handpiece is activated, if the wireless communication connection status indication as the off state, the wireless connection between the motor handpiece and the APP fails.	<ol style="list-style-type: none"> 1. The wireless connection has failed 2. Handpiece far from the APP. 	<ol style="list-style-type: none"> 1. Turn off the handpiece and restart 2. Place the handpiece near the APP and power on.
The contra- angle cannot be calibrated.	The calibration procedure may have been interrupted by increased resistance in the contra-angle.	<ol style="list-style-type: none"> 1. If calibration has been interrupted, calibrate the motor handpiece again to rule out the possibility of a motor fault. 2. Clean and lubricate the contra-angle. 3. Start the calibration procedure again.

Motor handpiece is getting hot.	Run time is too long with reciprocating mode	Allow the device to cool down and start themotor handpiece again.
Continuous rotary file blocks in the root canal	Wrong file setting. Too much pressure on the instrument.	Change the rotational direction by pressing the Rev/Fwd button. Start the handpiece and pull out the file carefully.
Reciprocating file blocks in the root canal.	Too much pressure on the instrument. File is not frequently cleaned.	Try to remove the file with a pair of pliers by pulling out and rotating the file gently clockwise.
APP cannot set parameters.	After wireless communication is established between the motor handpiece and APP, start the motor handpiece and the APP parameter setting function is prohibited.	1. Communication between the motor handpiece and APP fails, stop the motor handpiece, and the APP parameter setting function returns to normal. 2. Restart the motor handpiece, then stop the motor handpiece, APP parameter setting function returns to normal.
The handpiece cannot be switched on.	1. The battery is completely flat (all LEDs off). 2. The handpiece no longer responds (the LEDs are lit but the motor handpiece does not respond when the button is pressed). 3. The motor handpiece automatically switches to ready mode.	1. Connect the motor handpiece to charger (see 2.5.2 Connect the Motor handpiece). 2. Perform a reset 3. The multifunction button is faulty. Contact your service center.

8 Cleaning, Disinfection and Sterilization

8.1 Foreword

For hygiene and sanitary safety purposes, the contra-angle, the lip hook, the file clip, must be cleaned, disinfected and sterilized before each usage to prevent any contamination. This concerns the first use, as well as all subsequent uses.

8.2 General recommendations

8.2.1 Use only a disinfecting solution which is approved for its

efficacy (VAH/DGHM-listing, CE marking, FDA and Health Canada approval) and in accordance with the DFU of the disinfecting solution manufacturer.

8.2.2 Do not place the contra-angle in a disinfectant solution or in an ultrasonic bath. Do not use chloride detergent materials.

8.2.3 Do not use bleach or chloride disinfectant materials.

8.2.4 For your own safety, please wear personal protective equipment (gloves, glasses, mask).

8.2.5 The user is responsible for the sterility of the product for the first cycle and each further usage as well as for the usage of damaged or dirty instruments where applicable after sterility.

8.2.6 The water quality has to be convenient to the local regulations especially for the last rinsing step and is in.

8.2.7 To sterilize the endodontic files, refer to the manufacturer's instructions for use.

8.2.8 The contra-angle needs to be lubricated after cleaning and disinfection, but before sterilization.

8.3 Cleaning and disinfection steps for the motor handpiece, the AC adapter and the smart mobile device.

Before and After each use, all the objects that were in contact with infectious agents should be cleaned using towels impregnated with a disinfecting and detergent solution (a bactericidal, fungicidal and aldehyde free solution) approved by VAH/DGHM-listing, CE marking, FDA and Health Canada.



Warning: Do not sterilize the motor handpiece, the AC adapter and the smart mobile device.

8.3.1 Pre-Op processing

Before each use, the handpiece, charger, and smart mobile device must be cleaned and disinfected. The specific steps are as follows:



Warning: The handpiece, charger, and mobile smart device cannot be cleaned and disinfected with automatic equipment. Manual cleaning and disinfection is required.

8.3.1.1 Manual cleaning steps:

1. Take out the handpiece, charger, and smart mobile device on the workbench.

2. Wet the soft cloth completely with distilled water or deionized water, and then wipe all the surfaces of the components such as the handpiece, charger, mobile smart device, etc. until the surface of the component is not stained.

3. Wipe the surface of the component with a dry soft nap-free cloth.

4. Repeat the above steps at least 3 times.

Note:

a) Use distilled water or deionized water for cleaning at room temperature.

b) Manual disinfection steps:

1. Soak the dry soft cloth with 75% alcohol.

2. Wipe all surfaces of handpiece, charger, mobile smart device and other components with a wet soft cloth for at least 3 minutes.

3. Wipe the surface of the component with a dry soft nap-free cloth.

Note:

a) The cleaning and disinfection must be performed within 10min before use.

b) The disinfectant must be used immediately, no foaming is allowed.

c) In addition to 75% alcohol, you can use non-residue disinfectants such as Oxytech from Germany, but you must respect the concentration, temperature and time specified by the disinfectant manufacturer.

d) After cleaning and disinfecting the handpiece, you must install a disposable isolation sleeve before use and repeat steps 1, 2 and 3 to clean the disposable isolation sleeve (For detailed installation steps, see section 2.7).

8.3.2 Post-Op processing

After each use, clean and disinfect the handpiece, charger, and smart mobile device within 30 minutes. The specific steps are as follows:

Tools: Nap-free soft cloth, tray

1. Remove the contra-angle from the handpiece, place it in a clean tray, and then remove the disposable isolation sleeve from the handpiece.

2. Soak the nap-free soft cloth with distilled water or deionized water, and then wipe all the surfaces of the components such as the handpiece, charger, smart mobile device, etc. until the surface of the component is not stained.

3. Wet the dry soft cloth with 75% alcohol, and then wipe all surfaces of the handpiece, charger, mobile smart device and other components for 3 minutes.

4. Put the handpiece, charger, smart mobile device and other components back into the clean storage area.

Note:

a) The cleaning and disinfection must be performed within 10min before use.

b) The disinfectant must be used immediately, no foaming is

allowed.

c) In addition to 75% alcohol, you can use non-residue disinfectants such as Oxytech from Germany, but you must respect the concentration, temperature and time specified by the disinfectant manufacturer.

8.4 The cleaning, disinfection and sterilization of contra-angle, lip hook, file clip, touch probe are as follow.

Unless otherwise stated, they will be hereinafter referred to as "products" .

Warnings:

The use of strong detergent and disinfectant (alkaline pH>9 or acid pH <5) will reduce the life span of products. And in such cases, the manufacturer takes no responsibility.

The products may not be exposed to temperature above 138°C.

Processing limit

The products have been designed for a large number of sterilization cycles. The materials used in manufacture were selected accordingly. However with every renewed preparation for use, thermal and chemical stresses will result in ageing of the products. The maximum number of sterilizations for products is 250 times.

8.4.1 Initial processing

8.4.1.1 Processing principles

It is only possible to carry out effective sterilization after the completion of effective cleaning and disinfection. Please ensure that, as part of your responsibility for the sterility of products during use, only sufficiently validated equipment and product-specific procedures are used for cleaning/disinfection and sterilization, and that the validated parameters are adhered to during every cycle.

Please also observe the applicable legal requirements in your country as well as the hygiene regulations of the hospital or clinic, especially with regard to the additional requirements for the inactivation of prions.

8.4.1.2 Post-operative treatment

The post-operative treatment must be carried out immediately, no later than 30 minutes after the completion of the operation. The steps are as follows:

1. Remove the products from the APP, and rinse away the dirt on the surface of handpiece with pure water (or distilled water/ deionized water);
2. Dry the products with a clean, soft cloth and place them in a clean tray.

Notes:

a) The water used here must be pure water, distilled water or deionized water.

8.4.2 Preparation before cleaning Steps:

Tools: tray, soft brush, clean and dry soft cloth.

1. Remove the shanks/files.

2. Remove the file clip, isolation sleeve, Contra-angle and connecting wire from the handpiece in sequence, and then put them into a clean tray;

3. Use a clean soft brush to carefully brush lip hook, file clip, touch probe, head and back cover of the contra-angle until the dirt on surface is not visible. Then use soft cloth to dry the products and put them into a clean tray. The cleaning agent can be pure water, distilled water or deionized water.

Disassembling steps

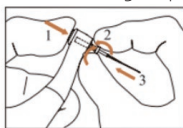

(a)

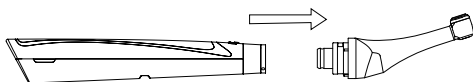

a) Press the push-button and pull out the shank/file.

b) Sliding it in the direction of the socket of handpiece and remove it from contra-angle. Otherwise it will be damaged.

8.4.3 Cleaning

The cleaning should be performed no later than 24 hours after the operation.

The cleaning can be divided into automated cleaning and manual cleaning. Automated cleaning is preferred if conditions permit.

8.4.3.1 Automated cleaning

- The cleaning agent is proved to be valid by CE certification in accordance with EN ISO 15883.
- There should be a flushing connector connected to the inner cavity of the product.
- The cleaning procedure is suitable for the product, and the irrigating period is sufficient.

It is recommended to use a washer-disinfector in accordance with EN ISO 15883. For the specific procedure, please refer to the

automated disinfection section in the next section "Disinfection".

Notes:

a) The cleaning agent does not have to be pure water. It can be distilled water, deionized water or multi-enzyme. But please ensure that the selected cleaning agent is compatible with the product.

b) In washing stage, the water temperature should not exceed 45 °C, otherwise the protein will solidify and it would be difficult to remove.

c) After cleaning, the chemical residue should be less than 10mg / L.

8.4.4 Disinfection

Disinfection must be performed no later than 2 hours after the cleaning phase. Automated disinfection is preferred if conditions permit.

8.4.4.1 Automated disinfection-Washer-disinfector

- The washer-disinfector is proved to be valid by CE certification in accordance with EN ISO 15883.

- Use high temperature disinfection function. The temperature does not exceed 134 ° C, and the disinfection under the temperature cannot exceed 20 minutes.

- The disinfection cycle is in accordance with the disinfection cycle in EN ISO 15883.

Cleaning and disinfecting steps by using Washer-disinfector

1. Carefully place the product into the disinfection basket. Fixation of product is needed only when the product is removable in the device. The products are not allowed to contact each other.

2. Use a suitable rinsing adaptor, and connect the internal water lines to the rinsing connection of the washer-disinfector.

3. Start the program.

4. After the program is finished, remove the product from the washer- disinfector, conduct inspection (refer to section "Inspection and Maintenance") and packaging (refer to chapter "Packaging"). Dry the product repeatedly if necessary (refer to section "Drying").

Notes:

a) Before use, you must carefully read the operating instructions provided by the equipment manufacturer to familiarize yourself with the disinfection process and precautions.

b) With this equipment, cleaning, disinfection and drying will be carried out together.

c) Cleaning: (c1) The cleaning procedure should be suitable for the product to be treated. The flushing period should be sufficient (5-10 minutes). Pre-wash for 3 minutes, wash for another 5 minutes,

and rinse it for twice with each rinse lasting for 1 minute. (c2) In the washing stage, the water temperature should not exceed 45 °C, otherwise the protein will solidify and it is difficult to remove. (c3) The solution used can be pure water, distilled water, deionized water or multi-enzyme solution, etc., and only freshly prepared solutions can be used. (c4) During the use of cleaning agent, the concentration and time provided by manufacturer shall be obeyed. The used cleaning agent is neodisher MediZym (Dr. Weigert).

d) Disinfection: (d1) Direct use after disinfection: temperature ≥ 90 °C, time ≥ 5 min or $A0 \geq 3000$;

Sterilize it after disinfection and use: temperature ≥ 90 °C, time ≥ 1 min or $A0 \geq 600$

(d2) For the disinfection here, the temperature is 93 °C, the time is 2.5 min, and $A0 > 3000$

e) Only distilled or deionized water with a small amount of microorganisms (< 10 cfu/ml) can be used for all rinsing steps. (For example, pure water that is in accordance with the European Pharmacopoeia or the United States Pharmacopoeia).

f) After cleaning, the chemical residue should be less than 10mg / L.

g) The air used for drying must be filtered by HEPA.

h) Regularly repair and inspect the disinfectant.

8.4.5 Drying

If your cleaning and disinfection process does not have an automatic drying function, conduct drying after cleaning and disinfection.

Methods:

1. Spread a clean white paper (white cloth) on the flat table, point the product against the white paper (white cloth), and then dry the product with filtered dry compressed air (maximum pressure 3 bar). Until no liquid is sprayed onto the white paper (white cloth), the product drying is completed.

2. Product can also be dried directly in a medical drying cabinet (or oven). The recommended drying temperature is 80°C~120°C and the time should be 15 ~ 40 minutes.

Notes:

a) The drying of product must be performed in a clean place.

b) The drying temperature should not exceed 138 °C;

c) The equipment used should be inspected and maintained regularly.

8.4.6 Inspection and maintenance

8.4.6.1 Inspection

In this chapter, we only check the appearance of the product.

1. Check the product. If there is still visible stain on the product after cleaning/disinfection, the entire cleaning/disinfection process must be repeated.

2. Check the product. If it is obviously damaged, smashed, detached, corroded or bent, it must be scrapped and not allowed to continue to be used.

3. Check the product. If the accessories are found to be damaged, please replace them before use. And the new accessories for replacement must be cleaned, disinfected and dried.

4. If the service time (number of times) of the product reaches the specified service life (number of times), please replace it in time.

8.4.6.2 Maintenance

Sterilizable Oil lubrication shall be applied to dried contra-angle.

The nozzle of cleaning lubricant is aligned with the air intake hole at the end of the contra-angle to inject oil for 1-2 seconds.

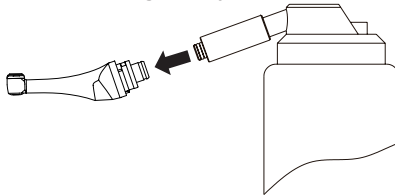

8.4.7 Packaging

Install the disinfected and dried product and quickly package it in a medical sterilization bag (FDA cleared wrap or pouch).

Notes:

- The package used conforms to ISO 11607;
- It can withstand high temperature of 138 °C and has sufficient steam permeability;
- The packaging environment and related tools must be cleaned regularly to ensure cleanliness and prevent the introduction of contaminants;
- Avoid contact with parts of different metals when packaging.

8.4.8 Sterilization

Use only the following steam sterilization procedures (fractional pre- vacuum procedure*) for sterilization, and other sterilization procedures are prohibited:

- The steam sterilizer complies with EN13060 or is certified according to EN 285 to comply with EN ISO 17665; or is cleared by FDA.

The validated sterilization cycle is one (1) fraction cycle, three (3)

consecutive half cycle and one (1) full cycle. The parameters are provided in the table below.

Mode	Vacuum	Temperature	Cycle	Exposure Time	Drying Time
PreVac	- 80 kPa	(132-134) °C	Fraction	30 seconds	20 minutes
			Half 1	2 minutes	20 minutes
			Half 2	2 minutes	20 minutes
			Half 3	2 minutes	20 minutes
			Full	4 minutes	20 minutes

Verification of the fundamental suitability of the products for effective steam sterilization was provided by a verified testing laboratory.

Notes:

a) Only products that have been effectively cleaned and disinfected

are allowed to be sterilized;

b) Before using the sterilizer for sterilization, read the Instruction Manual provided by the equipment manufacturer and follow the instructions.

c) Do not use hot air sterilization and radiation sterilization as this may result in damage to the product;

d) Please use the recommended sterilization procedures for sterilization. It is not recommended to sterilize with other sterilization procedures such as ethylene oxide, formaldehyde and low temperature plasma sterilization. The manufacturer assumes no responsibility for the procedures that have not been recommended. If you use the sterilization procedures that have not been recommended, please adhere to related effective standards and verify the suitability and effectiveness.

* Fractional pre-vacuum procedure = steam sterilization with repetitive pre-vacuum. The procedure used here is to perform steam sterilization through three pre-vacuums.

8.4.9 Storage

1. Store the product in a clean, dry, ventilated, non-corrosive atmosphere with a relative humidity of 10% to 93%, an atmospheric pressure of 70KPa to 106KPa, and a temperature of -20 °C to +55 °C;

2. After sterilization, the product should be packaged in a medical sterilization bag or a clean sealing container, and stored in a special storage cabinet. The storage time should not exceed 7 days. If it is exceeded, the product should be reprocessed before use.

Notes:

a) The storage environment should be clean and must be disinfected regularly;

b) Product storage must be batched and marked and recorded.

8.4.10 Transportation

1. Prevent excessive shock and vibration during transportation, and handle with care;

2. The product should not be mixed with dangerous goods during transportation.

3. Avoid exposure to sun or rain or snow during transportation.

9 Storage, transport and maintenance

9.1 Storage

9.1.1 This equipment should be stored in a room where the relative humidity is 10% ~ 93%, atmospheric pressure is 70kPa to 106kPa, and the temperature is -20°C ~ +55°C.

9.1.2 Avoid the storage in a too hot condition. High temperature will shorten the life of electronic components, damage battery, reshape or melt some plastic.

9.1.3 Avoid the storage in a too cold condition. Otherwise, when the temperature of the equipment increases to a normal level, there will be dew that will possibly damage PCB board.

9.2 Transport

9.2.1 Excessive impact and shake should be prevented in transportation.

9.2.2 Lay it carefully and lightly and don't invert it.

9.2.3 Don't put it together with dangerous goods during transportation.

9.2.4 Avoid solarization and getting wet in rain and snow during transportation.

9.3 Maintenance

9.3.1 This device do not include accessories for repair usage, the repair should be carried out by authorized person or authorized after service center. We will provide circuit diagrams, component part lists, descriptions, calibration instructions to assist to service personnel in parts repair

9.3.2 Keep the equipment in a dry storage condition.

9.3.3 Do not throw, beat or shock the equipment.

9.3.4 Do not smear the equipment with pigments.

9.3.5 In order to ensure the normal operation of the equipment, it is recommended to maintain the equipment once every two months, including checking whether the equipment is started up and charging the battery. Calibration is recommended when

using a new/other contra- angle or after an extended period of operation(At least once a month), as the running properties can change with usage, cleaning and sterilization. See section 3.6 for details.

9.3.6 Battery replacement

9.3.6.1 When the battery of the base or motor handpiece cannot be charged, or the base or the motor handpiece cannot be switched on and the battery needs to be replaced, it must be sent back to the manufacturer or replaced by the service personnel authorized by the manufacturer.

9.3.6.2 Battery replacement method:

- a) Turn the the motor handpiece power off.
- b) Use tweezers etc. to open the rubber cover and then remove the screw.
- c) Remove the battery cover.
- d) Remove the old battery and disconnect the connector.
- e) Connect the new battery and put it in the base or the motor handpiece.
- f) Replace the cover and its screw.

It is recommended to contact local distributors or manufacturer to replace the battery.

10 Environmental protection

Please dispose of the product according to the local laws.

11 After-sales service

From the date this equipment has been sold, based on the warranty card, we will repair this equipment free of charge if there are quality problems. Please refer to the warranty card for the warranty period.

12 Symbol instruction



Follow Instructions for Use



Serial number



Date of manufacture



Manufacturer

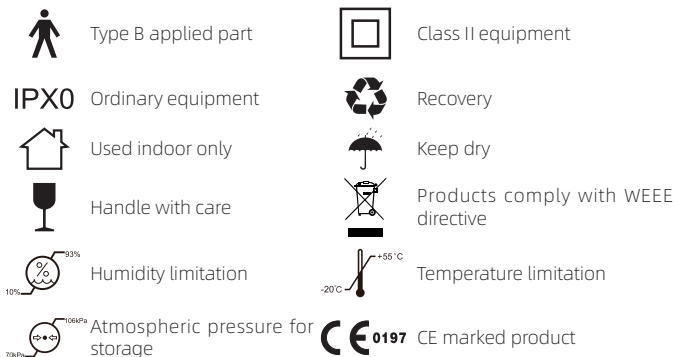

EC REP Authorised Representative in the EUROPEAN COMMUNITY

13 Statement

The pictures are only for reference. The final interpretation rights belong to GUILIN WOODPECKER MEDICAL INSTRUMENT CO., LTD. The industrial design, inner structure, etc, have claimed for several patents by WOODPECKER, any copy or fake product must undertake legal responsibilities.

14 EMC-Declaration of conformity

The device has been tested and homologated in accordance with EN 60601-1-2 for EMC. This does not guarantee in any way that this device will not be effected by electromagnetic interference. Avoid using the device in high electromagnetic environment.

Technical Description Concerning Electromagnetic Emission

Table 1: Declaration - electromagnetic emissions

Guidance and manufacturer's declaration - electromagnetic emissions		
The model Smart A is intended for use in the electromagnetic environment specified below. The customer or the user of the model Smart A should assure that it is used in such an environment.		
Emissions test	Compliance	Electromagnetic environment - guidance

RF emissions CISPR 11	Group 1	The model Smart A uses RF energy only for its internal function. Therefore, its RF emissions are very low and are not likely to cause any interference in nearby electronic equipment.
RF emissions CISPR11	Class B	
Harmonic emissions IEC 61000-3-2	Class A	
Voltage fluctuations / flicker emissions IEC 61000-3-3	Complies	

Technical Description Concerning Electromagnetic Immunity
Table 2: Guidance & Declaration - electromagnetic immunity

Guidance & Declaration — electromagnetic immunity			
The model Smart A is intended for use in the electromagnetic environment specified below. The customer or the user of the model Smart A should assure that It is used in such an environment.			
Immunity test	IEC 60601 test level	Compliance level	Electromagnetic environment - guidance
Electrostatic discharge (ESD) IEC 61000-4-2	±8kV contact ±2, ±4, ±8, ±15kV air	±8kV contact ±2, ±4, ±8, ±15kV air	Floors should be wood, concrete or ceramic tile. If floors are covered with synthetic material, the relative humidity should be at least 30 %.
Electrical fast transient/ burst IEC 61000-4-4	±2kV for power supply lines ±1kV for Input/ output lines	±2kV for power supply lines	Mains power quality should be that of a typical commercial or hospital environment.
Surge IEC 61000-4-5	±0.5, ±1kV line to line ±0.5, ±1, ±2kV line to earth	±0.5, ±1kV line to line ±0.5, ±1, ±2kV line to earth	Mains power quality should be that of a typical commercial or hospital environment.

Voltage dips, short interruptions and voltage variations on power supply input lines IEC 61000-4-11	<5 % UT (>95% dip in UT.) for 0.5 cycle <5 % UT (>95% dip in UT.) for 1 cycle 70% UT (30% dip in UT) for 25 cycles <5% UT (>95 % dip in UT) for 250 cycles	<5 % UT (>95% dip in UT.) for 0.5 cycle <5 % UT (>95% dip in UT.) for 1 cycle 70% UT (30% dip in UT) for 25 cycles <5% UT (>95 % dip in UT) for 250 cycles	Mains power quality should be that of a typical commercial or hospital environment. If the user of the model Smart A requires continued operation during power mains interruptions, it is recommended that the model Smart A be powered from an uninterruptible power supply or a battery.
Power frequency (50/60 Hz) magnetic field IEC 61000-4-8	30A/m	30A/m	Power frequency magnetic fields should be at levels characteristic of a typical location in a typical commercial or hospital environment.
NOTE UT is the a.c. mains voltage prior to application of the test level.			

Table 3: Guidance & Declaration - electromagnetic immunity concerning Conducted RF & Radiated RF

Guidance & Declaration - Electromagnetic immunity			
The model Smart A is intended for use in the electromagnetic environment specified below. The customer or the user of the model Smart A should assure that it is used in such an environment.			
Immunity test	IEC 60601 test level	Compliance level	Electromagnetic environment - guidance

<p>Conducted RF IEC 61000-4-6</p> <p>Conducted RF IEC 61000-4-6</p> <p>Radiated RF IEC 61000-4-3</p>	<p>3 Vrms 150 kHz to 80 MHz</p> <p>6 Vrms ISM frequency band</p> <p>3 V/m 80 MHz to 2.7 GHz</p>	<p>3V 6V 3V/m</p>	<p>Portable and mobile RF communications equipment should be used no closer to any part of the model Smart A, including cables, than the recommended separation distance calculated from the equation applicable to the frequency of the transmitter. Recommended separation distance $d=1.2 \times P^{1/2}$ $d=2 \times P^{1/2}$ $d=1.2 \times P^{1/2}$ 80 MHz to 800 MHz $d=2.3 \times P^{1/2}$ 800 MHz to 2.7 GHz P — the maximum rated output power of the transmitter provided by the transmitter manufacturer, in watts (W); d — the recommended separation distance, in meters (m). Field strengths from fixed RF transmitters are determined by an electromagnetic site survey "a", and in each frequency range "d" should be lower than the compliance level. Interference may occur in the vicinity of equipment marked with the following symbol: </p>
<p>NOTE 1 At 80 MHz and 800 MHz, the higher frequency range applies. NOTE 2 These guidelines may not apply in all situations. Electromagnetic propagation is affected by absorption and reflection from structures, objects and people.</p>			
<p>a Field strengths from fixed transmitters, such as APP stations for radio (cellular/cordless) telephones and land mobile radios, amateur radio, AM and FM radio broadcast and TV broadcast cannot be predicted theoretically with accuracy. To assess the electromagnetic environment due to fixed RF transmitters, an electromagnetic site survey should be considered. If the measured field strength in the location in which the model Smart A is used exceeds the applicable RF compliance level above, the model Smart A should be observed to verify normal operation. If abnormal performance is observed, additional measures may be necessary, such as reorienting or relocating the model Smart A.</p>			

Table 4: Recommended separation distances between portable and mobile RF communications equipment and the model Smart A

Recommended separation distances between portable and mobile RF communications equipment and the model Smart A

The model Smart A is intended for use in electromagnetic environment in which radiated RF disturbance is controlled. The customer or the user of the model Smart A can help prevent electromagnetic interference by maintaining a minimum distance between portable and mobile RF communications equipment (transmitters) and the model Smart A as recommended below, according to the maximum output power of the communications equipment.

Rated maximum output power of transmitter W	Separation distance according to frequency of transmitter m		
	150kHz to 80MHz $d=1.2 \times P^{1/2}$	80MHz to 800MHz $d=1.2 \times P^{1/2}$	800MHz to 2,7GHz $d=2.3 \times P^{1/2}$
0,01	0.12	0.12	0.23
0,1	0.38	0.38	0.73
1	1.2	1.2	2.3
10	3.8	3.8	7.3
100	12	12	23

For the maximum rated output power of the transmitter not listed in the table above, recommended separation distance “d” in meters (m) can be estimated using the equation applicable to the frequency of the transmitter, where “P” is the maximum rated output power of the transmitter provided by the transmitter manufacturer, in watts (W).

NOTE 1 At 80 MHz and 800 MHz, the separation distance for the higher frequency range applies.

NOTE 2 These guidelines may not apply in all situations. Electromagnetic propagation is affected by absorption and reflection from structures, objects and people.

Scan and Login website
for more information



Guilin Woodpecker Medical Instrument Co., Ltd.
Information Industrial Park, Guilin National High-Tech
Zone, Guilin, Guangxi, 541004 P. R. China

Sales Dept.: +86-773-5873196

[Http://www.glwoodpecker.com](http://www.glwoodpecker.com)

E-mail: woodpecker@glwoodpecker.com



MedNet EC-Rep GmbH
Borkstrasse 10 · 48163 Muenster · Germany

ZMN-SM-497 V1.1-20220418