

Diode Laser System Instruction Manual
Please carefully read this Manual before first use.

Instruction Manual of Semiconductor Laser Therapy Device



LX16 Plus

GUILIN WOODPECKER MEDICAL INSTRUMENT CO., LTD.

Contents

Forward.....	1
1 Product Introduction	1
2 Installation and functions.....	2
3 Operation.....	7
4 Precautions.....	15
5 Troubleshooting	16
6 Cleaning, disinfection and sterilization.....	16
7 Storage, maintenance, and transport	16
8 Environment protection	17
9 After-sales service	17
10 Electromagnetic compatibility	18
11 Symbols.....	23
12 Statement.....	24

Forward

Thank you for selecting LX 16 Plus Diode Laser System manufactured by Guilin Woodpecker Medical Instrument Co., Ltd. Woodpecker is an enterprise developing, producing and selling dental instruments. We have complete quality control system. To ensure correct and safe use of device, please carefully read this Instruction Manual before use.

1 Product Introduction

1.1 Introduction

The LX 16 Plus Diode Laser System realizes oral soft tissue surgery, periodontal disease, endodontic disease, pain treatment, soft laser therapy and other oral diseases by vaporizing, carbonizing and solidifying the tissue by laser.

Features:

- a) Using a capacitive touch screen which has clear display and is easy to operate;
- b) Built-in large-capacity rechargeable lithium battery with longer time of endurance;
- c) The handpiece sleeve and the fiber tip can be autoclaved to prevent cross infection;
- d) Preset more than 20 treatment procedures to reduce the difficulty of use.
- e) A secure protection mechanism that automatically shuts down the device after 5 minutes of inactivity;

1.2 Model

LX 16 Plus

1.3 Configuration

Please refer to the Packing List.

1.4 Structures and components

This device consists of a main unit, a laser transmission system, and a power adapter. The main unit includes a semiconductor laser, a power supply system and a control device, a safety protection device, a display device, etc.

1.5 Scope of application

The device realizes oral soft tissue surgery, periodontal disease, pulp disease, pain treatment, soft laser therapy and other oral diseases by vaporizing, carbonizing and solidifying the tissue.

1.6 Contraindications

- Patients with hemophilia are not allowed to use.
- Patients with pacemakers are not allowed to use.

Doctors with a pacemaker are not allowed to use.

Patients with heart disease, pregnant women and young children should be cautious to use.

1.7 Device safety classification

Classified by operation mode: Continuous operation

Type of protection against electric shock: For charging, it is Class I device; For working, it is Class II internal power supply device.

Degree of protection against electric shock: B type applied part

Degree of protection against harmful ingress of water: Ordinary equipment (IPX0), not waterproof

Degree of safety application in the presence of a flammable anesthetic mixture with air, oxygen, or nitrous oxide: Equipment cannot be used in the presence of a flammable anesthetic mixture with air, oxygen, or nitrous oxide.

1.8 Main technical parameters

Power adapter input: 100-240Vac, 50/60Hz, 2.5A

Main unit input: 15V 6.0A

Wavelength and power:

a) $450 \pm 20\text{nm}$: $P_{\text{max}} = 3\text{W}$;

b) $650 \pm 20\text{nm}$: $P_{\text{max}} = 200\text{mW}$;

c) $976 \pm 20\text{nm}$: $P_{\text{max}} = 5\text{W}$;

Laser classification:

a) 976 nm: Class IV;

b) 650 nm: Class II;

c) 450 nm: Class IV;

(According to IEC 60825-1)

Aiming beam: $650 \pm 20\text{nm}$ / $P_{\text{max}} < 5\text{mW}$

Rechargeable battery: 11.1V/2600mAh x2 (57.7Wh)

Time consumption for charging: about 4h (5 hours for first charging)

size: 22cm x 20cm x 23cm

Weight: 1.5kg

1.9 Operation circumstance

1.9.1 Temperature: $+5^{\circ}\text{C} \sim +40^{\circ}\text{C}$

1.9.2 Humidity: 30% ~ 75%

1.9.3 Air pressure: 70kPa ~ 106kPa

2 Installation and functions

Schematic diagram of the whole machine, components and control buttons.

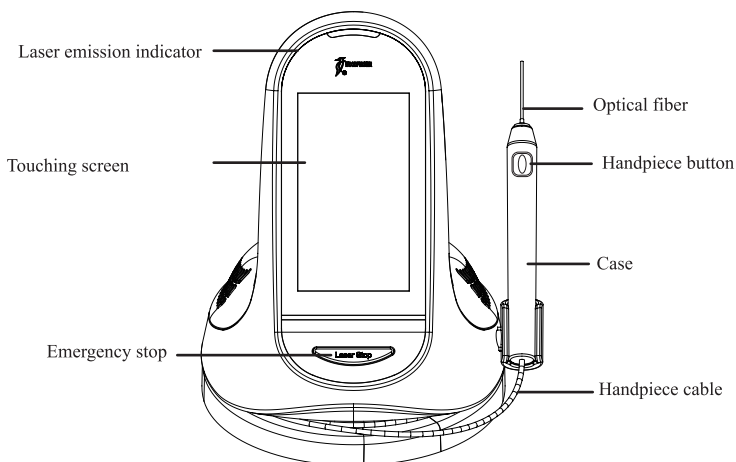

Figure 1 Front view of device

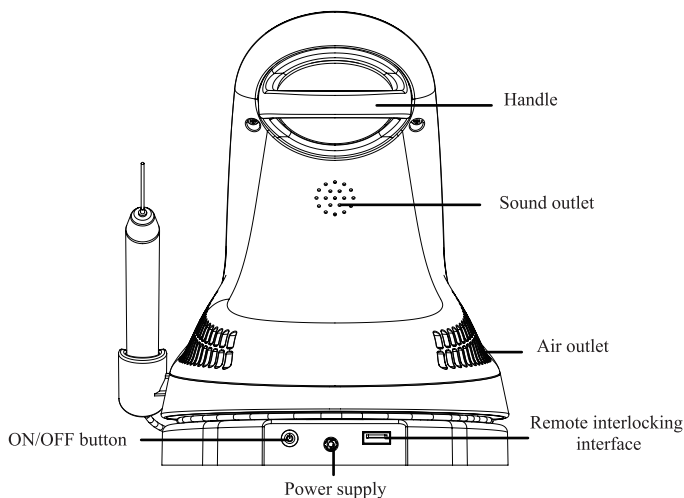

Figure 2 Rear view of the device

2.1 Installation of accessories

Installation area

Remove all parts from the box, taking care not to drop or damage the unit. Install the device in the area to be used. Note that there should be enough space around the device to make the fiber handpiece wire have a large bending diameter

to prevent breakage. At the same time, do not have other items to block the air outlet on the side of the device.

Installation of power adapter

Take out the power adapter and power supply cable from package and connect them as shown in the picture.

Note: Only the power adapter and power supply cable coming with the device can be used.

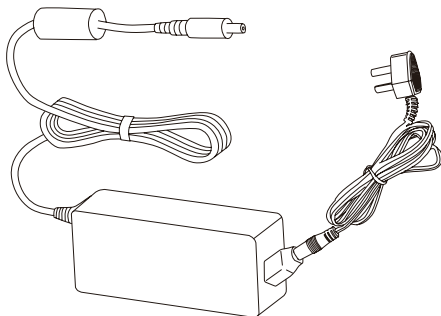

Figure 3 Assembly diagram of power adapter and power supply cable

Installation and removal of dustproof plug

Remove the dustproof plug on the handpiece counterclockwise as shown in Figure 5.

Tighten the dustproof plug clockwise as shown in Figure 6.

[Note] When the device is not in use, the dustproof plug should be tightened to prevent dust from entering the tip of the handpiece to contaminate the lens.

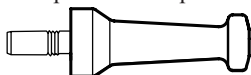

Figure 4 Dustproof plug

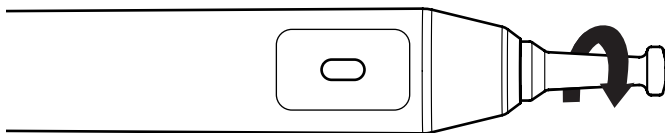

Figure 5 Dustproof plug removal diagram

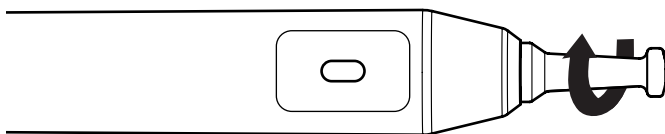

Figure 6 Dustproof plug assembly diagram

Assembly and removal of fiber tip

Remove the fiber tip and screw it in the clockwise direction after inserting it into the handpiece. As shown in Figure 7, remove the fiber tip and put it into the tip box to prevent the fiber from breaking. Rotate counterclockwise when disassembling, as shown in Figure 8. After removing the fiber tip, install the dustproof plug according to the method in section 2.2.3.

[Note] When installing and removing the fiber tip, keep the tip surface clean and please do not touch the surface of fiber tip.

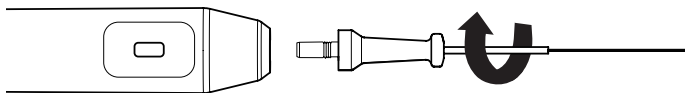

Figure 7 Fiber tip assembly diagram

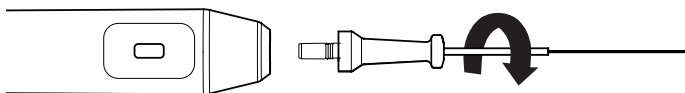

Figure 8 Fiber tip removal diagram

Installation and removal of physiotherapy tip, whitening tip and biostimulation tip.

Select the appropriate tip, rotate it in a clockwise direction to install, and rotate it in a counterclockwise direction to remove as shown in Figure 9. Please remove the tip and place it properly after the treatment is completed. After removing the tip, install the dustproof plug according to the method in section 2.2.3.

[Note] When installing and disassembling the physiotherapy tip, whitening tip, and bio-stimulating tip, keep the working tip surface clean and do not touch the tip surface.

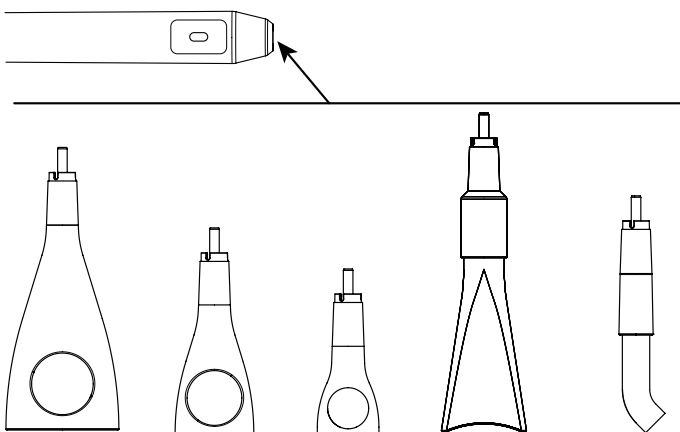

Figure 9 Installation diagram of physiotherapy tip, whitening tip and biostimulation tip

Installation and removal of handpiece sleeve

The handpiece sleeve of the device is replaceable. The installation can be completed by carefully inserting the sleeve into the handpiece as shown in Figure 10; when disassembling, please press the handpiece switch to pull out the sleeve as shown in Figure 11.

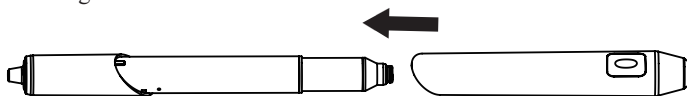

Figure 10 Installation diagram of handpiece sleeve
Handpiece switch



Figure 11 Removal diagram of handpiece sleeve

Storage of handpiece tail cord

The handpiece tail cord of this device contains extremely fine glass fiber which is easy to break. Do not bend the cord greatly during use and avoid it from being squeezed by other objects. Therefore, please be careful to store the cord as shown in Figure 12 when the device is not in use.

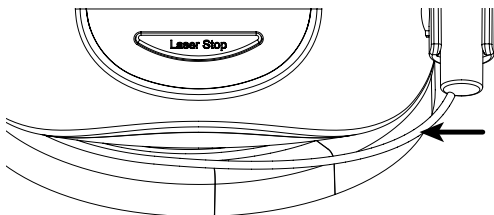

Figure 12 Diagram of handpiece tail cord storage

Installation of remote control interlock (optional)

Remote interlocking is a safety device that terminates laser radiation whenever the door of the treatment room is opened. This device can also be used normally without the remote interlock. When this function is required, install the corresponding control switch K on the door of the room, and connect the two control cables of the control switch to the "A" and "B" ports of the remote control interlock. As shown in Figure 13, when the control switch K is short-circuited, this device works normally, and this device will be prohibited from emitting laser light when the control switch K is open. Remote interlocking can work when plugging the USB into the USB port of this device as shown in Figure 14.

[Note] The installation of the remote control interlock must be completed by a qualified electrician who is responsible for the installation and maintenance of the electrical system to which the equipment is connected.

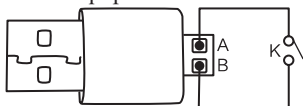

Figure 13 Wiring diagram of remote control interlock

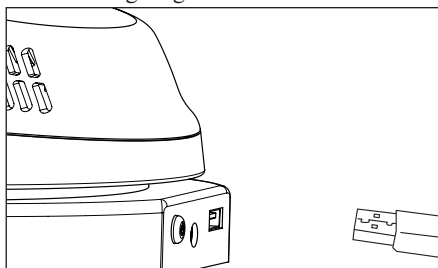

Figure 14 Installation diagram of remote control interlock

3 Operation

3.1 Touching screen

As shown in Figure 15, press the "ON/OFF" button on the back of the device

to turn it on, then enter the user password on the display screen (the initial user password is "8888") and press OK to enter the desktop menu of the device as shown in Figure 16.

Press the "ON/OFF" button directly when powering off the device.

Note

The administrator password "6363" and the initial user password "8888" can be used to open the device. The user password can be modified in the setting interface, but the administrator password cannot be modified.

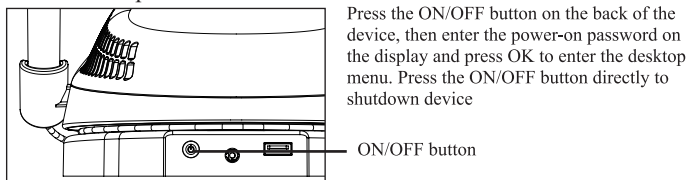

Figure 15 Schematic diagram of ON/OFF button



Figure 16 The greeting interface and password inputting interface

Select a preset program

As shown in Figure 17, there are 4 desktop menus, among which the first three are the preset treatment programs with preset parameters. They can be used according to the default parameters. The fourth is the user-defined program menu (refer to section 3.1.9-3.1.10 for more details)..

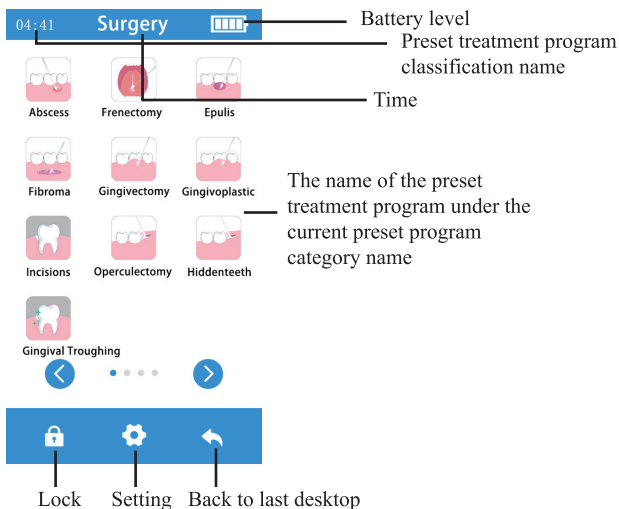

Figure 17 Preset treatment program interface

Treatment parameter adjustment

The device can set the peak power, frequency, duty cycle, time by keyboard input, and automatically calculate the effective power and energy (there is a numerical range limit, and there will be a corresponding prompt when the value exceeds the limit).

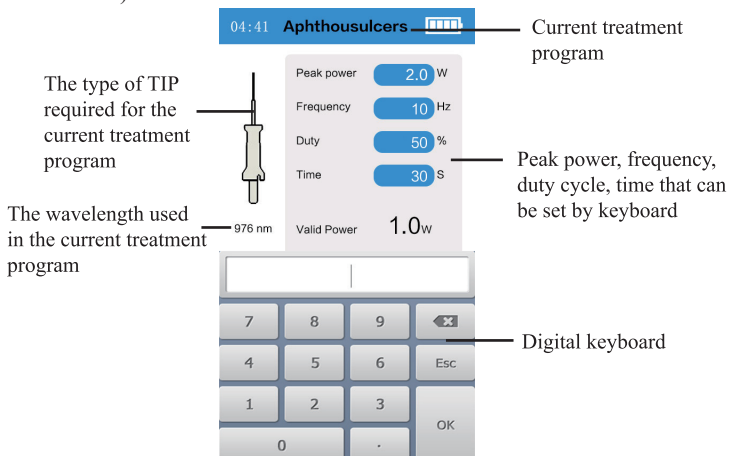

Figure 18 Treatment parameter adjustment interface

Treatment instructions and aiming beam adjustment

After selecting the treatment procedure, there are instructions for the corresponding treatment procedure, and display of the effective power and energy.

There are 3 levels of aiming beam, which can be adjusted as needed as shown in Figure 19.

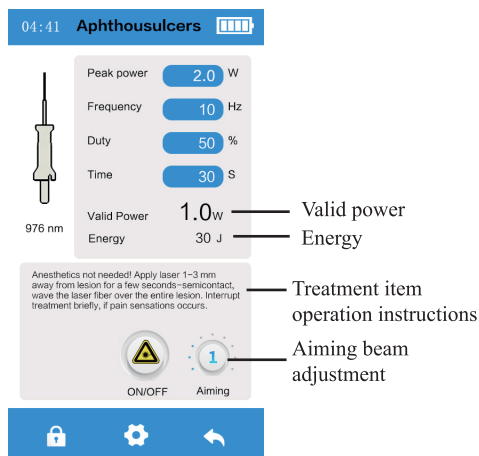

Figure 19 Schematic diagram of treatment instructions and aiming beam adjustment

Laser emission ready

Click the “Switch” button on the screen to prepare for laser emission. The device will prompt to wear the protective glasses. Click “Yes” button after wearing the glasses, enter the laser emission ready state after 2s countdown, and the “Switch” button will display “Ready”, and the indicator at the top of the screen is green as shown in Figure 20;



Figure 20 Schematic diagram of prompt of wearing glasses, Ready state, and green indicator

Check of laser emission aiming beam

In the laser emission ready state, the top end of the fiber tip emits a red aiming aura as shown in Figure 21. The method can be used to detect whether the optical path transmission system works well. It is recommended to check before each treatment.

[Note] Please use the new fiber optic tip. If the red aiming aura is an evenly rounded circle when it is about 8cm away from the white paper surface, the optical path transmission system of this device works well. Otherwise, check out the troubleshooting section in Chapter 5.

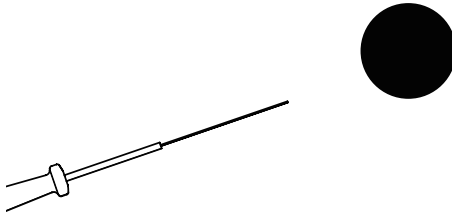

Figure 21 Schematic diagram of red aiming aura

Laser emission

When the laser emission is in the ready state, press the laser emission button on handpiece to emit laser. When emitting laser, there will be audible sound prompt, and the top of the screen would alternately flash green and blue as shown in Figure 22. There will also be countdown. The laser emission will automatically stop as soon as the countdown ends. After it stops emitting laser, release the button to return to normal.

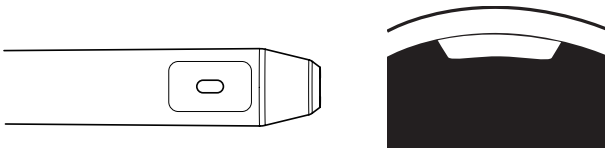

Figure 22 Laser emission button on handpiece and blue indicator light during laser emission

Stop emitting laser

As shown in Figure 23, the laser emission can be stopped by releasing the laser emission button or pressing the emergency stop button or pressing the laser emission "switch" button or pressing the machine lock button or the end of countdown,.

In addition, in order to prevent high temperature damage to the laser emission device, the device will automatically stop emitting laser when the internal temperature of the laser is higher than 60 °C. During the laser emission process, it is necessary to monitor whether the aiming beam is normally output at any time to verify whether the entire optical path system is working properly. If the aiming beam is found to be abnormal, stop the laser emission immediately.

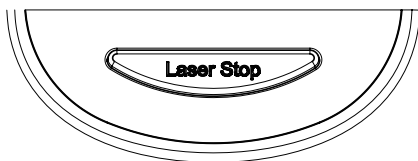

Figure 23 Emergency stop button "Laser Stop" and lock machine button

Modification of name of user-defined program

As shown in Figure 24, click on the system default program name in the middle of the top of the screen, and the system would automatically pop up the input keyboard. After the input is completed, click the "Enter" button.

[Note] Only the name of user-defined program name be modified.

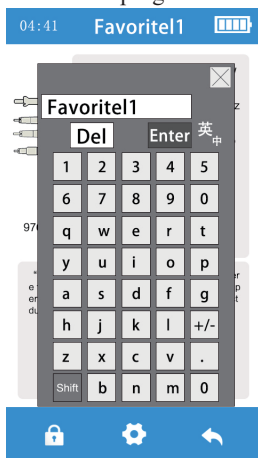

Figure 24 Schematic diagram of user-defined program name modification

User-defined program parameter settings and saving

As shown in Figure 25, click the parameter you want to modify, the system will pop up the numeric keypad; after entering the required parameters, click the save button, the system prompts "Save", click "Yes" to save the parameters, click "No" to return without saving. Click on the wavelength section to select the desired wavelength.

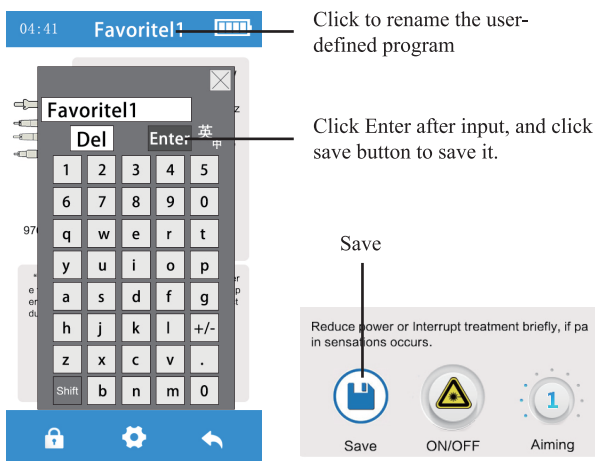

Figure 25 Schematic diagram of setting and saving of user-defined program parameters

Setting interface function description

As shown in Figure 26, enter the setup menu to perform system property settings.

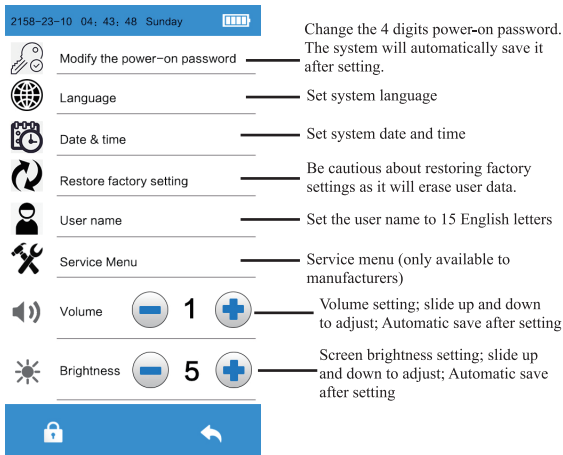

Figure 26 Setting interface function description

Charging

After plugging in the power adapter (original adapter only):

a) As shown in Figure 27, when the power is off, the charging icon will

display the charging; when it is fully charged, it will display the full grid.

b) As shown in Figure 28, after booting up, a yellow prompt icon will appear in the upper right corner of the device screen, and green will appear when it is full charged.



Figure 27 The prompting icon of charging under power-off state



Figure 28 The prompting icon of charging under power-on state

Wearing laser goggles

As shown in Figure 29, during the use of this equipment, all personnel in the room (such as doctors, assistants, and patients. Other non-related personnel need to leave the treatment room.) need to wear the laser goggles provided by the manufacturer. The laser goggles that were not provided by manufacturer cannot be used.

For doctors or assistants

For doctors or assistants

For patients

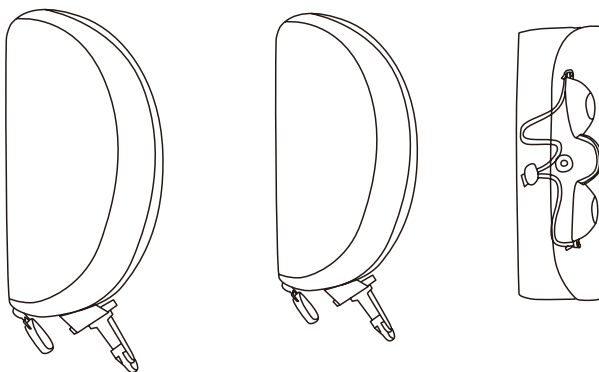

Figure 29 Laser goggles wearing instruction

Cutting fiber

During soft tissue surgery, proteins may cover the fiber end face and affect cutting efficiency. At this point, the protein should be removed or the part of the fiber should be cut off; the end face of the fiber should be cut before the irradiation treatment is needed; as shown in Figure 31, when cutting, use the fiber-cutting pen to gently traverse the fiber, and then break it with the appropriate

force at the lined position. A neat fiber tip can be obtained. Discard the removed fiber in a container that is specially filled with sharp waste. Also check the aiming beam spot (Please refer to section 3.1.6 for more details of operation).

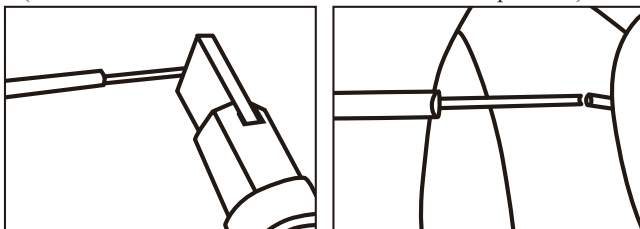

Figure 31 Schematic diagram of cutting the fiber

4 Precautions

4.1 Precautions for operation

The device should be kept clean before and after use.

Please check whether the aiming beam output of this device is normal before each clinical operation (Please refer to section 3.1.6 for more details of operation).

All personnel in the treatment room such as doctors, assistants, and patients must wear laser goggles. Do not look directly into the laser during use; lasers may cause harm when human skin or other objects are exposed to it at close range.

Product operation must comply with the relevant medical and operational regulations and relevant regulations, and should only be used by trained doctors or technicians.

Do not pull or sharply bend the tail wire during the use of the device to avoid damage to the tail wire.

Do not hit or scratch the handpiece.

After operation, turn off the power and unplug the power cord.

Our company is specialized in the production of medical devices, only when the maintenance, repair and modification of this equipment is operated by our company or our authorized dealers, and the replacement parts are woodpecker brand accessories and the replacement is operated according to the instruction manual, we are responsible for the security.

5 Troubleshooting

Fault	Cause	Solution
Without visible aiming beam	Aiming beam setting is too low / optical fiber tip is damaged	Press the "Aim at Beam" button to increase the setting of the aiming beam / replace the new fiber optic tip.
Working beam cannot be cut	The set power is too low	Increase power. If the power is set above 3 W, the working beam still does not work, please replace the optical fiber tip. If it still does not work properly, please contact the dealer.

If the above method cannot eliminate the fault, please contact the dealer and return the equipment to the dealer for returning it to the factory for processing. Do not attempt to open the casing of the machine and repair it yourself, which may result in electric shock or laser leakage.

6 Cleaning, disinfection and sterilization

The touch panel and handpiece tail cord can be cleaned with a soft cloth dampened with a water-based cleaner or disinfectant. The recommended disinfectant is 70% isopropyl alcohol. To avoid wear, do not use a hard tool to clean it.

The laser handpiece sleeve, fiber tip and physiotherapy tip can be autoclaved and placed in a box than can be sterilized under high temperature. The temperature, pressure, and consuming time of sterilization should be: 134 ° C, 2.0 bar ~ 2.3 bar (0.20MPa ~ 0.23MPa), 4min.

Goggles can be wiped with a soft cloth or soaked in a normal temperature disinfectant solution. Do not sterilize it under high temperature.

The handpiece contains precise optical lens which cannot be cleaned (except the handpiece sleeve); therefore, it should be protected from water ingress.

Do not use volatile and diffluent solvents for cleaning, which can damage the surface of the device or cause the markings on the device to fade.

7 Storage, maintenance, and transport

7.1 Storage and maintenance

The equipment should be handled carefully and lightly. Be sure that it is far from the vibration, and installed or kept in a cool, dry, and ventilated place.

Do not store the machine together with articles that is poisonous, combustible, caustic, or explosive.

This machine should be stored in a room where the relative humidity is 10%~93%, atmospheric pressure is 70kPa~106kPa, and the temperature is -20°C~+55°C.

7.2 Transport

Excessive impact and shake should be prevented during transport. Lay it carefully and lightly. Avoid placing it upside down.

Do not put it together with dangerous goods during transport

12.6 Avoid being exposed to sun, rain, and snow during transport.

8 Environment protection

The device does not contain any harmful ingredients. It can be disposed or destroyed in accordance with the relevant local regulations.

Part	Toxic or harmful substances or elements					
	Pb	Hg	Cd	Cr6+	PBB	PBDE
Handpiece	○	○	○	○	○	○
Main unit	○	○	○	○	○	○
Power adapter	○	○	○	○	○	○
Tip	○	○	○	○	○	○
Mechanical elements, including bolts, nuts, washers, etc.	○	○	○	○	○	○

○: Indicates that the content of the toxic substance in all homogeneous materials of the part is below the limit requirement stipulated in SJ/T-11363-2006 Limit Requirements for Toxic and Hazardous Substances in Electronic Information Products.

×: indicates that the content of the toxic substance in at least one of the homogeneous materials of the part exceeds the limit requirement specified in SJ/T-11363-2006.

(This product meets EU RoHS environmental protection requirements; there is currently no mature technology in the world to replace or reduce the content of lead in electronic ceramics, optical glass, steel and copper alloy.)

According to the Administrative Measures on the Restriction of the Use of Hazardous Substances in Electrical and Electronic Products and the Regulations on the Management of the Recycling of Waste Electrical and Electronic Products and related standards, please observe the safety and precautions of the products, and after use, please recycle or dispose this product after according to the methods in local laws and regulations

9 After-sales service

Since the date of sales, for the device what has quality problem, with Warranty Card, our company is responsible for the repair. Please refer to the Warranty Card for the warranty period and scope. This product does not contain any accessories that can be repaired by users. The device can only be repaired by authorized

professional personnel or in authorized repair shop.

10 Electromagnetic compatibility

Note

a) LX 16 Plus type Diode Laser System meets the requirements of electromagnetic compatibility in YY0505-2012 standard.

b) The user should install and use the device according to the electromagnetic compatibility information provided in the accompanying file.

c) Portable and mobile RF communications equipment may affect the performance of the LX 16 Plus Diode Laser System. During operation, avoid strong electromagnetic interference such as being close to cell phones, microwave ovens, etc. Please refer to following table for the details of guidelines and manufacturer's declarations.

Warnings

a) LX 16 Plus Diode Laser System should not be used close to or stacked with other equipment. If it must be used close to or stacked, it should be observed to be able to operate normally in its configuration. Except the cables of LX 16 Plus sold by the manufacturer as spare parts for internal components, the use of other accessories and cables may result in increased emissions or reduced immunity of the LX 16 Plus Diode Laser System.

b) Use of accessories, tips or cables that were not provided by LX 16 Plus manufacturer with LX 16 Plus and systems may result in increased emissions or reduced immunity of the LX 16 Plus Diode Laser System.

c) The cables specified below must be used to comply with the requirements of electromagnetic emissions and immunity.

10.1 Requirements for cable installation

No.	Cable	Length	Whether to shield?
1	Handpiece tail cord	2m	No
2	Power supply cord	1.5m	No
3	Output cable of power adapter	2.0m	No

10.2 Key components of electromagnetic compatibility

The key components of electromagnetic compatibility of this product are power supply cord, main circuit board, fuse, IC chip. The use or replacement of non-conformed accessories, cables, transducers, etc. will result in significantly reduced electromagnetic compatibility emission and immunity performance. Do not replace the parts of this equipment without authorization.

10.3 Guidance and manufacturer's declaration – electromagnetic emissions

Guidance and manufacturer's declaration – electromagnetic emissions		
LX 16 Plus is intended for being used in the electromagnetic environment specified below. The customers or users of LX 16 Plus should assure that it is used in such an environment.		
Emission test	Compliance	Electromagnetic environment – guidance
RF emissions GB 4824	Group 1	LX 16 Plus use RF energy only for its internal function. Therefore, its RF emissions are very low and are not likely to cause any interference in nearby electronic device.
RF emissions GB 4824	Class B	LX 16 Plus is suitable for being used in domestic establishment and in establishment that is directly connected to a low voltage power supply network which is for domestic power supply.
17625.1	Class A	
Voltage fluctuations/ flicker emissions GB 17625.2	Compliance	

10.4 Guidance and manufacturer's declaration – electromagnetic immunity

Guidance and manufacturer's declaration – electromagnetic immunity			
LX 16 Plus is intended for being used in the electromagnetic environment specified below. The customers or users of LX 16 Plus should assure that it is used in such environment.			
Immunity test	IEC 60601 test level	Compliance level	Electromagnetic environment – guidance
Electrostatic discharge GB/T 17626.2	±6kV Contact discharge ±8kV Air discharge	±6kV Contact discharge ±8kV Air discharge	Floors should be made of wood, concrete or ceramic tile. If floors are covered with synthetic material, the relative humidity should at least reach 30%.
GB/T 17626.4 Electrical fast transient bursts GB/T 17626.4	±2kV For power supply lines	±2kV For power supply lines	Mains power should be of the quality to be used in commercial or hospital environment.
Surge GB/T 17626.5	±1kV Line to line ±2kV Line to earth	±1kV Line to line	Mains power should be of the quality to be used in commercial or hospital environment.
Voltage dips, short interruption and voltage variations on power supply input lines. GB/T 17626.11	<5%UT, (> 95% dip in UT) for 0.5 circle 40%UT, (60% dip in UT) for 5 circles 70%UT, (30% dip in UT) for 25 circles <5%UT, (> 95% dip in UT) for 5s	<5%UT, (> 95% dip in UT) for 0.5 circle 40%UT, (60% dip in UT) for 5 circles 70%UT, (30% dip in UT) for 25 circles <5%UT, (> 95% dip in UT) for 5s	Mains power should be of the quality to be used in commercial or hospital environment. If the user of LX 16 Plus requires continued operation during power mains interruptions, it is recommended that the LX 16 Plus be powered from an uninterruptable power supply or a battery.
Power frequency magnetic field (50/60Hz) GB/T 17626.8	3A/m	3A/m (50Hz)	Power frequency magnetic field should be at levels characteristic of a typical location in a typical commercial or hospital environment.
Note: U_T is the alternative current mains voltage prior to application of the test level.			

10.5 Guidance and manufacturer's declaration – electromagnetic immunity

LX 16 Plus is intended for being used in the electromagnetic environment specified below. The customers or users of LX 16 Plus should assure that it is used in such environment.

Immunity test	IEC 60601 test level	Compliance level	Electromagnetic environment - guidance
G B / T 17626.3 Conducted RF G B / T 17626.6 Radiated RF G B / T 17626.	3 V r m s 150kHz~80MHz 3V/m 80MHz~2.5GHz	3Vrms 3V/m	<p>Portable and mobile RF communications equipment should not be used closer than the recommended separation distance to any part of LX 16 Plus, including cables. The separation distance should be calculated from the corresponding formula of transmitter frequency.</p> <p>Recommended separation distance: 80MHz~800MHz 800MHz~2.5GHz</p> <p>P is the maximum rated power output of the transmitter in Watts (W) provided by transmitter manufacturer. d is the recommended separation distance in meters (m).</p> <p>As field strength from fixed RF transmitters is determined by an electromagnetic site survey a, therefore it should be less than the compliance level in each frequency range.</p> <p>Interference may occur near the device marked by the following symbols.</p> 

Note 1: At 80MHz and 800MHz frequency, adopt formula of higher frequency range.

Note 2: These guidelines may not apply in all situations. Electromagnetic propagation is affected by absorption and reflection from buildings, objects, and human body.

a. Field strengths from fixed transmitters, such as base stations for radio (cellular/cordless) telephones and land mobile radios, amateur radio, AM and FM radio broadcast and TV broadcast cannot be predicted theoretically with accuracy. To assess the electromagnetic environment due to fixed RF transmitters, an electromagnetic site survey should be taken into consideration. If the measured field strength in the location where LX 16 Plus is used exceeds the applicable RF compliance level above, the LX 16 Plus should be observed to verify normal operation. If abnormal performance is observed, additional measures may be necessary, such as reorienting or relocating the LX 16 Plus.

b. Over the frequency range 150kHz to 80MHz, field strengths should be less than 3V/m.

10.6 Recommended separation distance between portable and mobile RF communications equipment and the LX 16 Plus

Recommended separation distance between portable and mobile RF communications equipment and the LX 16 Plus

LX 16 Plus is intended for being used in electromagnetic environment where radiated RF disturbances is controlled. As per the maximum power output of communication device, the customer or user of LX 16 Plus can help to prevent electromagnetic interference by maintaining a minimum distance between portable and mobile RF communication device (transmitter) and LX 16 Plus recommended below.

Maximum rated power output of transmitter/ W	Separation distance according to frequency of transmitter/ m		
	150kHz~80MHz	80MHz~800MHz	800MHz~2.5GHz
0.01	0.12	0.12	0.23
0.1	0.38	0.38	0.73
1	1.2	1.2	2.3
10	3.8	3.8	7.3
100	12	12	23

For transmitters rated at a maximum output power not listed above, the recommended separation distance d in meters (m) can be estimated using the equation applicable to the frequency of the transmitter, where P is the maximum output power rating of the transmitter in watts (W) according to the transmitter manufacturer.

Note 1: At 80MHz and 800MHz, the separation distance for the higher frequency range applies.

Note 2: These guidelines may not apply in all solutions. Electromagnetic propagation is affected by absorption and reflection from buildings, objects, and human body.





















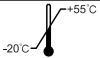



Note

a) Without the consent of Guilin Woodpecker Medical Instrument Co., Ltd., unauthorized modification of the device may result in electromagnetic compatibility problems of this device or other device.

b) The design and testing of Diode Laser Systems are in compliance with related operating procedures of electromagnetic compatibility.

11 Symbols

 WOODPECKER	Trademark		Follow Instructions for Use
	Manufacturer		Date of manufacture
	B type applied part		Use indoor only
	Product serial number		Products comply with WEEE directive
IPX0	Ordinary equipment	DC 15V	15V Direct current input
	Power switch		Avoid exposed to rain
	Temperature limitation for storage		Humidity limitation for storage
	Atmospheric pressure for storage		Sterilization under high temperature
	Caution! Avoid scalding		Fragile items, handle with care
	Laser radiation warning		Safety warning sign

	Connect remote control interlock		Tip of handpiece emits laser
	When using the device, 4 types of laser radiation can be generated.		
	“Laser Stop” button; if there is emergency situation, press this button.		

12 Statement

Woodpecker reserves the right to change the design of the equipment, the technique, fittings, instruction manual and the content of the original packing list at any time without further notice. The pictures are only for reference. The final interpretation rights belong to Guilin Woodpecker Medical Instrument Co., Ltd.

(Please refer to the packaging label for the date of manufacture. Service life: 5 years)

Scan and Login website
for more information



Guilin Woodpecker Medical Instrument Co., Ltd.
Information Industrial Park, Guilin National High-Tech
Zone, Guilin, Guangxi, 541004 P. R. China

Tel:

Europe Sales Dept.: +86-773-5873196, +86-773-2125222

North America, South America &

Oceania Sales Dept.: +86-773-5873198, +86-773-2125123

Asia & Africa Sales Dept.: +86-773-5855350, +86-773-2125896

Fax: +86-773-5822450

E-mail: woodpecker@glwoodpecker.com, sales@glwoodpecker.com

Website: <http://www.glwoodpecker.com>