

### Product Highlights

- Our Standard Intensity Linear Backlights provide rugged construction for demanding environments.



### General Specifications

	Color	24V Current	All Other Controls
Electrical Specifications	880	0.03A per inch	0.020A Max per inch
	660	0.03A per inch	0.025A Max per inch
	470, 520, WHI	0.03A per inch	0.018A Max per inch
Normal Operating Temperature	0 - 60°C		
Weight	12" unit - 212.3g (7.5oz)		
Standard Cable Information	2 m long -0/+150 mm (80" -0/+6") - 105°C rated PVC jacket, foil shield with drain.		
Photobiological Risk Factor	Exempt Applicable Wavelengths: 880 Group 1 (Low-Risk) Applicable Wavelengths: 470, 520, 660, WHI		
Compliance	CE, RoHS, IEC 62471		
IP Rating	IP50		
Lumen Maintenance	L70 = 50,000 hours		

## Part Number Key

Model	Emitting Length (in)	—	Peak Wavelength	Connector/Control	—	Alternative Connector
BL193	XX	-	XXX	XX	-	XXX
BL193	01" increments from 01" to 80"		455 (blue) 470 (blue) 530 (green) 590 (green) 625 (red) 850 (IR) 940 (IR) WHI (white)	C1 C5 IC I3 I3S 24		M8 <sup>1</sup> M12 <sup>1</sup>
EX: BL19306-470C5 BL19324-625I3-M12		<sup>1</sup> Available with IC, I3, I3S, and 24 V				

See website product page for in-stock product numbers.

**Shipping:**

Stock Products: within three days

Build-to-Order Products: within one to three weeks

## Change Notice

PCN No: 152

Date Issued: June 15, 2020

Notice Type: Product Revision Change

Product Type: BLXXYY, CBXXYY, FDXXYY, BL128, BL193, BL245

### Change Notification Summary

In an effort to improve our products, Advanced illumination (Ai) will be updating the internal drivers and white LEDs used in the BLXXYY, CBXXYY, FDXXYY, BL128, BL193, and BL245. This change will result in white lights seeing a brightness increase of roughly 70% while maintaining equal pricing for small configurations and reduced pricing for large configurations. Excluding the BL128, 24V configured units will experience a current draw shift from 20mA to

30mA per sq. inch for 470nm, 520nm and white units while controller configured units will see a current draw shift from 15mA to 18mA per sq. inch for the same color configurations. Color temperatures will remain unchanged.

The LED upgrade and internal driver update for white color configurations will take place September 15th. The internal driver updates will occur November 9th for 470nm and January 7th for 520nm.

Please contact your Ai Sales Representative if you have any questions.

PCN 152

## Mechanical Specs

BL193 LENGTH MATRIX	
PART #	LENGTH IN INCHES [mm]
BL19301	1.475 [37.47 mm]
BL19302	2.475 [62.87 mm]
BL19303	3.475 [88.27 mm]
BL19304	4.475 [113.7 mm]
BL19305	5.475 [139.1 mm]
BL19306	6.475 [164.5 mm]
1" INCREMENTS UP TO MAX OF 80"	

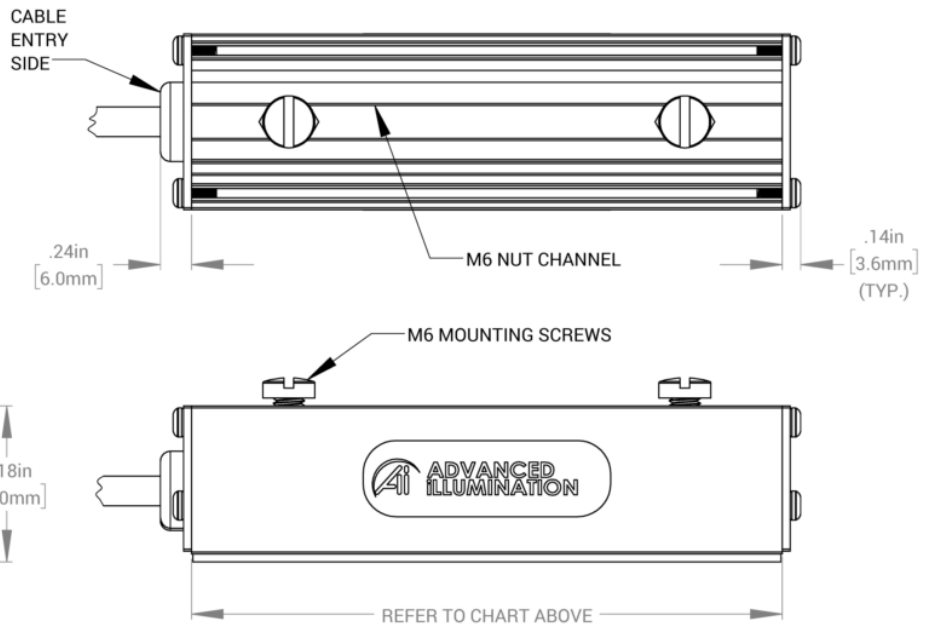
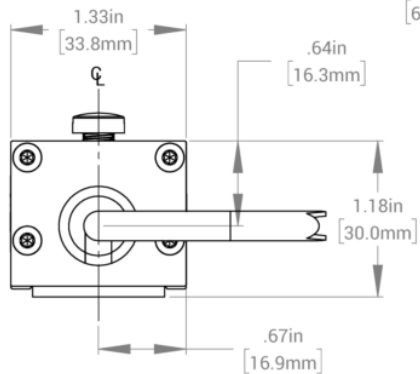

Optical Specs

Area of Illuminance & Intensity

Working Area (FWHM)  
@ Working Distance

289.5 X 22.9 (mm)  
@surface



Light Output

Irradiance (W/M<sup>2</sup>): Min 38.6; Typ 45.4  
Illuminance (kLux): Min 11.9; Typ 14

Intensity Distribution

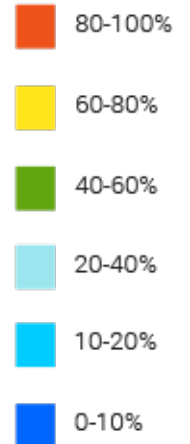
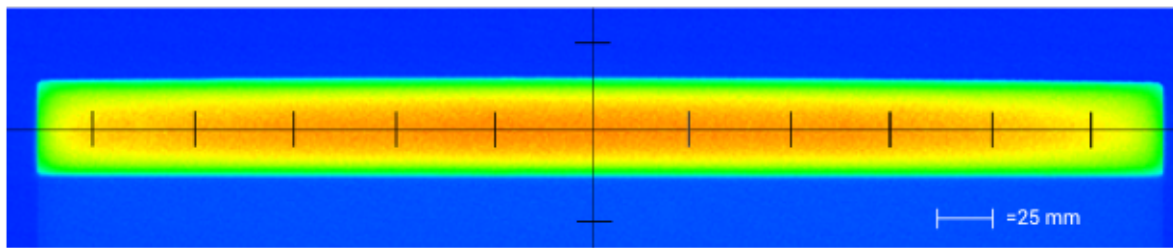

Optical measurement taken using BL19312-WHII3

### Standard Flying Lead Functions for 24V, IC, I3 and I3S Control Options

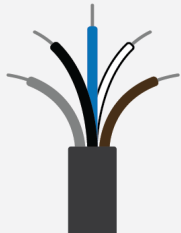
	COLOR	24V FUNCTIONS	IC FUNCTIONS	I3/I3S FUNCTIONS
	BROWN	24 V DC	24 V DC	24 V DC
	WHITE	N/A	0-10 V ANALOG DIMMING	RESERVED
	BLUE	DC GND	DC GND	DC GND
	BLACK	N/A	PNP/ACTIVE LOW GATE	PNP/ACTIVE HIGH TRIGGER
	GRAY	N/A	N/A	0-10 V ANALOG DIMMING

The functions listed above are applicable when this product is configured with built-in 24V, IC, I3, or I3S control, **without** the optional A-coded 5-position Male M12 or A-coded 4-position Male M8 connector.

### M12 Connector Pinout Functions for 24V, IC, I3 and I3S Control Options

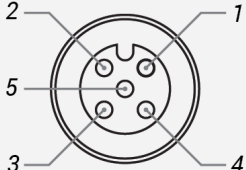
	PIN	24V FUNCTIONS	IC FUNCTIONS	I3/I3S FUNCTIONS
	1	24 V DC	24 V DC	24 V DC
	2	N/A	0-10 V ANALOG DIMMING	RESERVED
	3	DC GND	DC GND	DC GND
	4	N/A	PNP/ACTIVE LOW GATE	PNP/ACTIVE HIGH TRIGGER
	5	N/A	N/A	0-10 V ANALOG DIMMING

The functions listed above are only applicable when this product is configured with built-in 24V, IC, I3, or I3S control, **with** an A-coded 5-position Male M12 connector.

### M8 Connector Pinout Functions for 24V, IC, I3 and I3S Control Options

	PIN	24V FUNCTIONS	IC FUNCTIONS	I3/I3S FUNCTIONS
	1	24 V DC	24 V DC	24 V DC
	2	N/A	0-10 V ANALOG DIMMING	0-10 V ANALOG DIMMING
	3	DC GND	DC GND	DC GND
	4	N/A	PNP/ACTIVE LOW GATE	PNP/ACTIVE HIGH TRIGGER

The functions listed above are only applicable when this product is configured with built-in 24V, IC, I3, or I3S control, **with** an A-coded 4-position Male M8 connector.

For details on operating configurations without built-in control (C1, C5, Q1, and Q4 control, when available), please refer to Advanced illumination's controller manuals.

## Control Specs

C1 Connector	C5 Connector	ICS 2 (IC)	ICS 3 (I3)	ICS 3S (I3S)	24
<p><i>For use with:</i>  <b>DCS Series            Controllers</b></p>	<p><i>For use with:</i>  <b>Pulsar 320 Strobe            Controller.</b></p>	<p>Continous in-line            controller   <i>Powered with:</i>  <b>24V power supply</b></p>	<p>Combination            strobe/continous            in-line controller   <i>Powered with:</i>  <b>24V power supply</b></p>	<p>Default-OFF            strobe/continous            in-line controller   <i>Powered with:</i>  <b>24V power supply</b></p>	<p>Flying/tinned leads   <i>Powered with:</i>  <b>24V power supply</b></p>

## Warranty Information

Every Advanced illumination, Inc. (Ai) product is thoroughly inspected and tested before leaving the factory. Products are warranted to be free of defects in workmanship and materials for a period of FIVE YEARS from the original date of purchase. Should a defect develop during this period, customers may return the complete product, freight prepaid, to one of Ai's distributors or to the Ai factory. All product warranty returns require a Return Merchandise Authorization (RMA) number which is obtained from Customer Service. The RMA number must be clearly marked on the outside of the package. Ai will inspect the unit, and if a defect is found will, at our option, repair or replace the product without charge. Ai disclaims liability for any implied warranties, including implied warranties of "merchantability" and "fitness for a specific purpose." For products under warranty that have since been discontinued, Ai will make an effort to replace with equivalent parts; for circumstances that do not allow for equivalent replacement, Ai reserves the right to repair or replace these products with an updated version. Ai cannot be held responsible for the unauthorized or inappropriate use of its products. Any unauthorized repair or modifications will result in a voided warranty.

No Liability for Consequential Damages: In no event shall Ai be liable for any consequential, special, incidental, or indirect damages of any kind arising from the sale or use of the products.

## Electromagnetic Compatibility

This product was tested and complies with the regulatory requirements and limits for electromagnetic compatibility (EMC) as stated in the product specifications. These requirements and limits are designed to provide reasonable protection against harmful interference only when the product is operated in its intended industrial electromagnetic environment. To minimize the potential for electromagnetic interference or unacceptable performance degradation, install and use this product in strict accordance with the instructions in the product documentation.

## Customer Service

For information on existing orders, or to make an order adjustment, contact us Monday through Friday 8:00 am to 5:00 pm ET or send an email to [orders@advancedillumination.com](mailto:orders@advancedillumination.com).

## Company Information

### **Advanced Illumination**

440 State Garage Road, Rochester, VT 05767

Phone: 802.767.3830

Fax: 802.767.2636

Email: [info@advancedillumination.com](mailto:info@advancedillumination.com)

Web: [advancedillumination.com](http://advancedillumination.com)

© 2021 Advanced illumination Inc. All rights reserved