

S75G2 Brick Light SPOT LIGHT

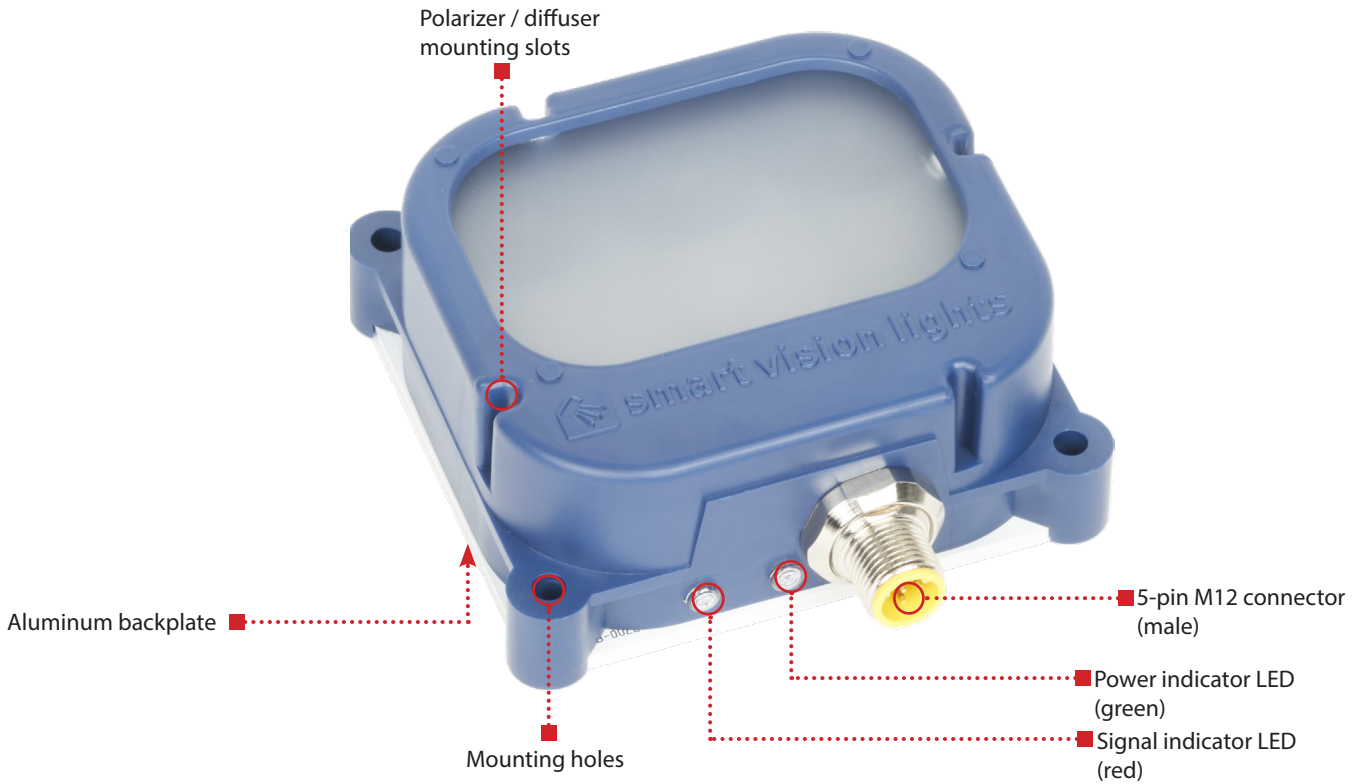

The S75G2 is a spot light featuring an integrated Multi-Drive™ driver that can produce up to 300,000 lux. NPN or PNP triggers can be used to control the light for either OverDrive™ or continuous operation. Light intensity can be controlled via 1 - 10 VDC analog intensity line or remotely using SmartVisionLink™*.

S75G2 HIGHLIGHTS

Warranty 10 YEAR	Tested IEC 62471	Compliant CE ROHS	Rated IP 50	Connector 5-PIN M12
--------------------------------	--------------------------------	---------------------------------	---------------------------	-----------------------------------

- ✓ SmartVisionLink™-enabled for easy intensity adjustment.
- ✓ MultiDrive™ provides both OverDrive™ and continuous mode functionality.
- ✓ Built-in status indicators
- ✓ Available in short wave infrared
- ✓ Compact, low profile footprint.

*SmartVisionLink requires purchase of the BTM-1000 bluetooth module



SPECIFICATIONS

	Continuous Operation	OverDrive Operation
Electrical Input	24 VDC +/- 5%	
Input Current	Max. 400 mA	Peak 3 A during strobe
Input Power	Max. 9.6 W	Peak 72 W during strobe
PNP Trigger	2 mA @ 4VDC 7 mA @ 12VDC 13.4 mA @ 24VDC	
NPN Trigger	12 mA @ Common (0VDC)	
Trigger Input	PNP > +3.3 VDC (24 VDC max.) to activate or NPN ≥ GND <1VDC to activate (not both)	
Mode Control	Connect pin 5 to 1-10 VDC (10 - 100% output); 24 VDC (Max)	Connect pin 5 to GND (See wiring configuration for more information)
Strobe Duration	Min. 10 μs Max. ∞	Min. 10 μs Max. 50 ms (see SafeStrobe™ Technology for more information)
Strobe Frequency	Not Applicable	Max 4 kHz or 1 / Duty Cycle as calculated, whichever is less. ¹
Strobe Trigger Latency	6 μs	6 μs
Duty Cycle	Not Applicable	Max 10% ¹
Power Indicator	Turns green when powered up	
Status Indicators	Strobe indicator will turn red when on	
Analog Intensity	The output is adjustable from 10% - 100% of intensity limit by a 1 - 10 VDC signal. Jumpering pin 5 to pin 1 will provide maximum intensity. Intensity can be remotely adjusted via SmartVisionLink™ ²	
Connection	5-pin M12 connector	
Operating Temperature	-10° to 40° C (14° to 104° F) RH max 80% non-condensing humidity	
Storage Temperature	-20° to 70° C (-4° to 158° F) RH max 80% non-condensing humidity	
IP Rating	IP50	
Weight	~155 g	
Compliances	CE, IEC 62471, RoHS	
Warranty	10 years ³	

¹See page 6 for more information

²SmartVisionLink™ requires the purchase of the BTM-1000 bluetooth module, sold separately, and the SmartVisionLink™ app, free to download on the Apple App and Google Play stores.

³See SmartVisionLights.com/warranty for details.

WIRING CONFIGURATION

CONTINUOUS OPERATION MODE

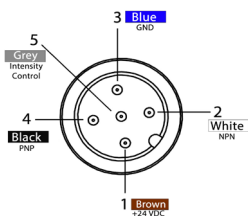

Pin layout for light (Male Connector)

Pins	Function	Signal	Wire Color
1	Power In	+24 VDC	BROWN
2	NPN	Sinking Signal	WHITE
3	GND	Ground	BLUE
4	PNP	Sourcing Signal	BLACK
5	Intensity Control	1-10 VDC	GREY

For maximum intensity, it is possible to tie pin 5 to pin 1 at +24VDC.

For continuous mode: PNP (pin 4) can be tied to +24 V DC (pin 1) **or** NPN (pin 2) can be tied to Ground (pin 3).

For proper light function, apply either a PNP or NPN signal, not both.

Failure to supply light with correct input current will result in inconsistent lighting behavior.

(see Product Specifications for requirements)

OVERDRIVE OPERATION MODE

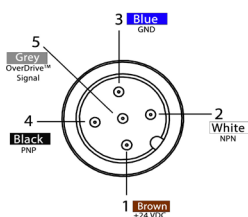

Pin layout for light (Male Connector)

Pins	Function	Signal	Wire Color
1	Power In	+24 VDC	BROWN
2	NPN	Sinking Signal	WHITE
3	GND	Ground	BLUE
4	PNP	Sourcing Signal	BLACK
5	OverDrive™ Signal	Ground	GREY

Failure to supply light with correct input current will result in inconsistent lighting behavior.

(see Product Specifications for requirements)

LIGHTING PATTERNS

The S75G2 is recommended to be used at a working distance between 300 mm to 2000 mm. Illuminance values taken on white light - 5700K

Standard (10°) lighting patterns

Illuminance vs. Working Distance

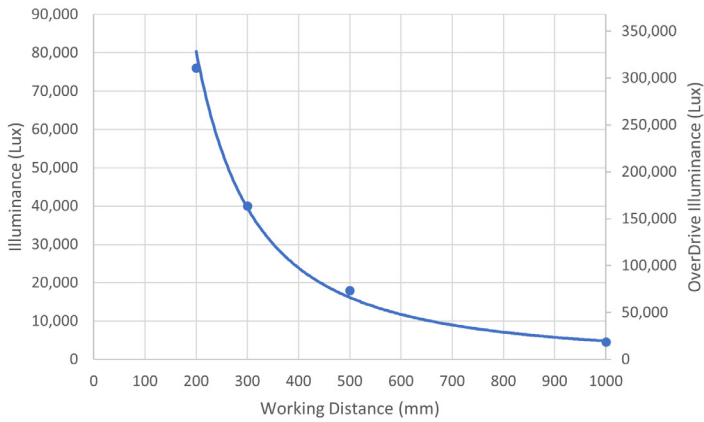

Beam Size at 80% Max Intensity vs. Working Distance

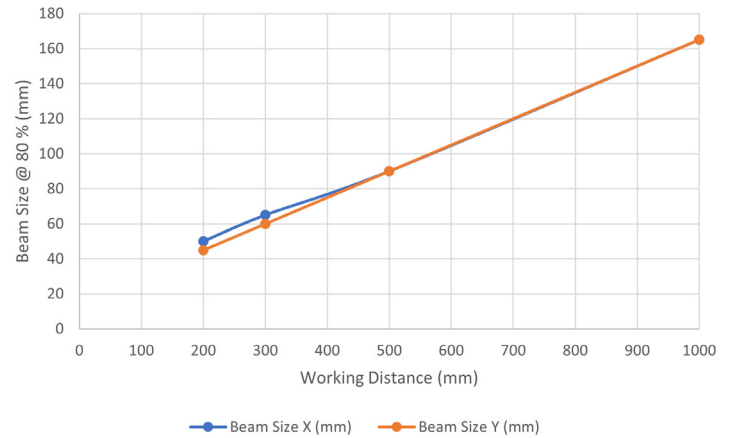

Wide (30°) lighting patterns

Illuminance vs. Working Distance

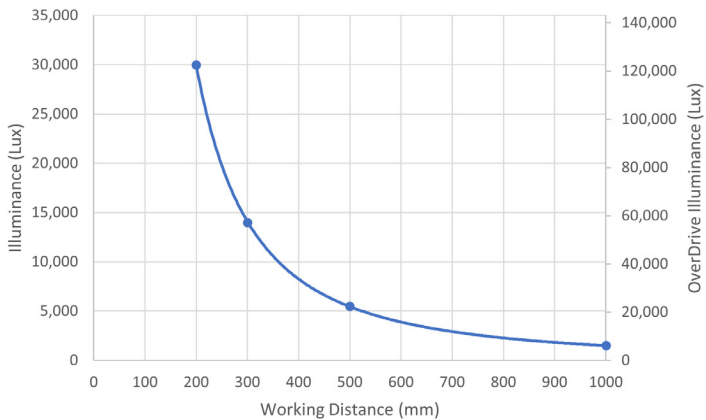

Beam Size at 80% Max Intensity vs. Working Distance

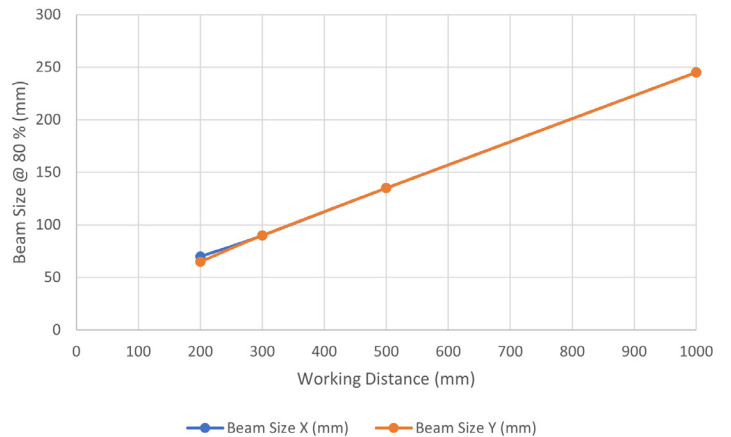

BEAM PATTERNS

The S75G2 is recommended to be used at a working distance between 300 mm to 2000 mm. Illuminance values taken on white light - 5700K

Standard (10°) beam patterns

Grid set to 75 mm

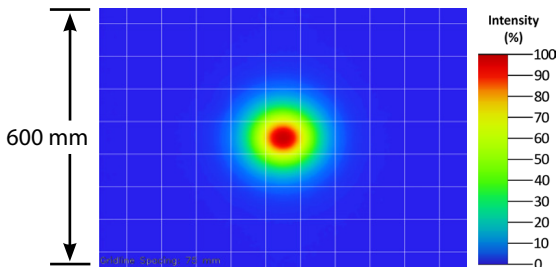

300 mm working distance

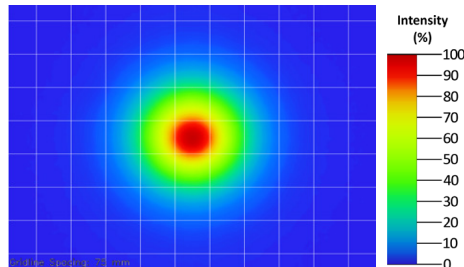

500 mm working distance

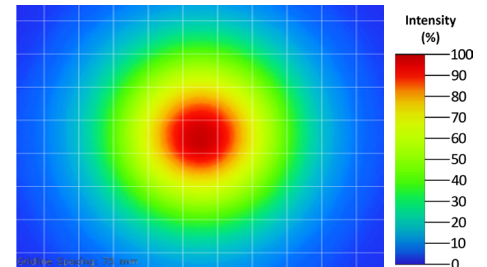

1000 mm working distance

Wide (30°) beam patterns

Grid set to 75 mm

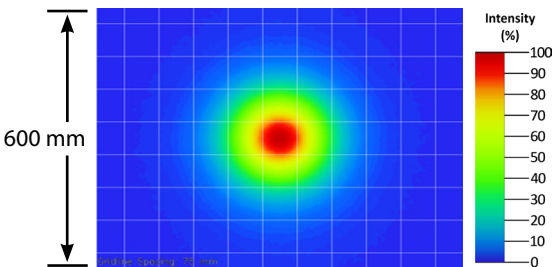

300 mm working distance

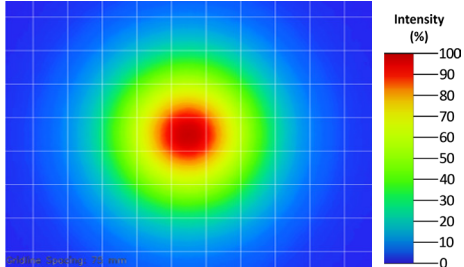

500 mm working distance

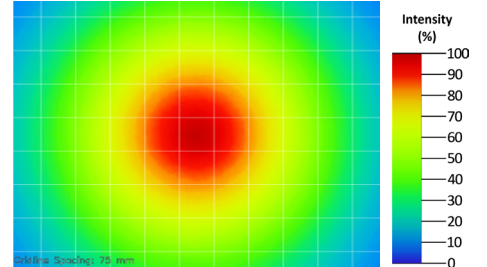

1000 mm working distance

LENS OPTICS

NARROW (Standard)

Narrow, 10° angle-cone lenses are standard. Standard lenses create a narrow beam of illumination and are used for long working distances.



WIDE

Wide, 30° angle-cone lenses create a large area of illumination. They create a floodlight effect and can be used for short working distances.

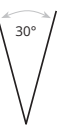

MOUNTING

Mounting options on the S75G2 Series of Brick Light include four holes. See accessories for additional mounting options.

Example of the S75G2 using the Pan and Tilt Mount (Part Number: PB75-M5.)

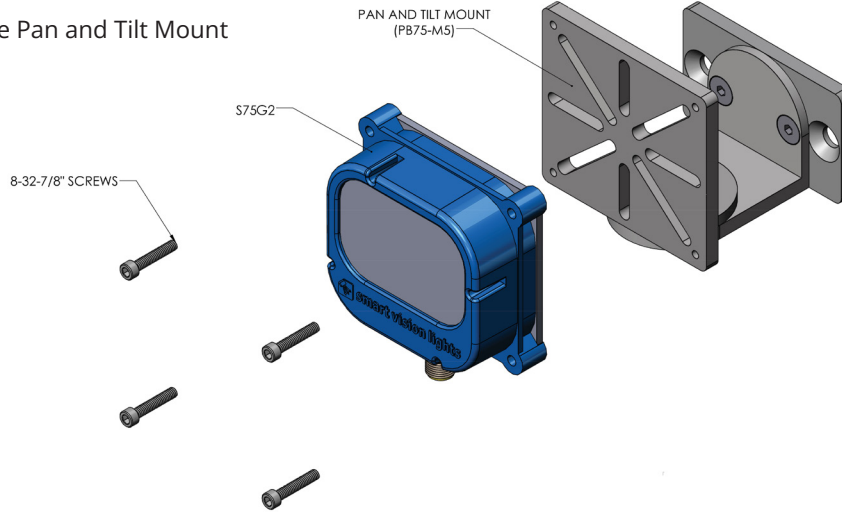

EYE SAFETY

According to IEC 62471:2006. Full documentation available upon request with purchase of product.

Notice

Exempt Group: No photobiological hazard to eyes or skin even for continuous, unrestricted use. Applicable for wavelengths 625, 850, 940, 1050, 1200, 1300, 1450, 1550, and 1650.

Caution

Risk Group 1: Possibly hazardous optical radiation emitted from this product. Do not stare at operating lamp. May be harmful to eyes. Safe for most applications except prolonged exposure. Applicable for wavelengths 470, 505, 530, and WHI.

Warning

Risk Group 2: UV emitted from this product. Eye or skin irritation may result from exposure. Use appropriate shielding. Applicable for wavelengths 365 and 395.

ILLUMINATION

The S75G2 works best for:

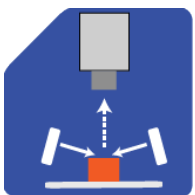

Dark Field

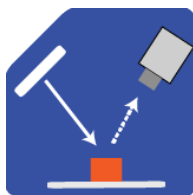

Bright Field

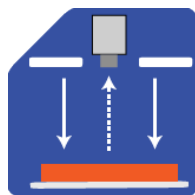

Direct Lighting

DUTY CYCLE

This section applies only if light is in OverDrive™ strobe mode.

The Duty Cycle (D) is related to the Strobe Time (ST) and Rest Time (RT).

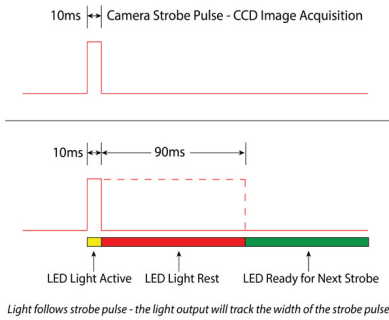

Calculating Rest Time

$$RT = \frac{ST}{D} - ST$$

RT = Rest Time
ST = Strobe Time
D = Duty Cycle

Example

$$90 \text{ ms} = \frac{10 \text{ ms}}{.1} - 10 \text{ ms}$$

Rest Time is 90 ms for 10 ms Strobe Time

Calculating Strobe Rate

$$SR = \frac{D}{ST}$$

SR = Strobe Rate (strokes per second)
ST = Strobe Time (seconds)
D = Duty Cycle

Example

$$1000 = \frac{0.1}{0.0001}$$

Strobe Rate is 1000 strokes per second

Calculating Duty Cycle

$$D = ST \times SR$$

SR = Strobe Rate (strokes per second)
ST = Strobe Time (seconds)
D = Duty Cycle

Example

$$0.1 = 0.0001 \times 1000$$

Duty Cycle is 10% (0.1)

Maximum Duty Cycle for OverDrive™ light is 10% (0.1)

Maximum Strobe Frequency is 1/ calculated duty cycle or 4,000 strokes per second, whichever is less.

MULTI-DRIVE™

Multi-Drive provides both continuous and OverDrive™ modes from a single integrated driver. Users can select the lighting mode via the input wiring configuration. With OverDrive, the light can be strobed at up to 10 times the intensity* of continuous mode.



*See lighting section for more information on this light's OverDrive values.

SAFESTROBE™

SafeStrobe™ is a unique technology that applies safe working parameters to ensure high current LEDs are not damaged by driving them beyond their limits, such as maximum strobe time or duty cycle. This is especially beneficial for overdriving our high current LEDs.

SMARTVISIONLINK™

The S75G2 series is SmartVisionLink™-enabled and is designed so intensity can be adjusted using the SmartVisionLink™ app.

SmartVisionLink™ provides a way for a light to communicate with an app on a mobile device or tablet. This technology allows users to adjust the intensity of the light in both continuous operation and OverDrive™ strobe mode. By connecting the BTM-1000 Bluetooth module to a light that is SmartVisionLink™-enabled, a user can adjust parameters for the light. The SmartVisionLink™ app is available free to download in the Apple App and Google Play Stores.

The BTM-1000 Bluetooth module acts as an intensity limiting device. Intensity levels set and saved by the module are intensity limits, or ceilings, that the analog signal will then modify.

For example, assume the intensity level is set to 50% by the BTM-1000. If the analog signal is set to 10% intensity, the intensity of the light will be 10% of the 50% ceiling, rather than 10% of the lights total limit.



CONNECTING A BTM-1000

The BTM-1000 can be connected directly to a light or attached to a jumper cable that is connected to a light. Once the light's intensity is set to a desired level, the BTM-1000 can be removed from the light or cable.

The pigtail end of the BTM-1000 is connected directly to the light or to the cable attached to the light - sold separately.



*For reference only. Diagram not to scale.

PART NUMBER GUIDE

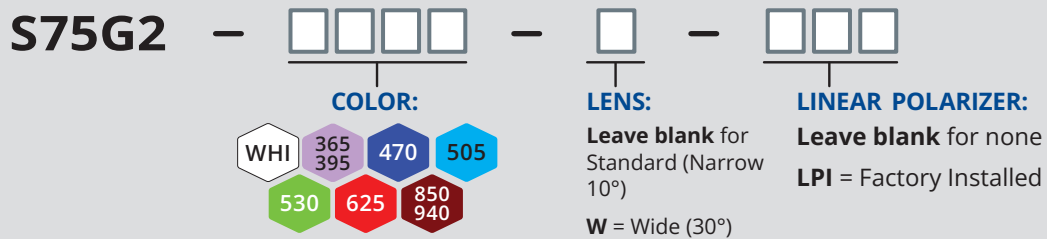

Part Number Examples

- S75G2-625** S75G2, 625 nm Red Wavelength, Standard (10° Narrow) lenses
- S75G2-WHI-W** S75G2, White Wavelength, Wide Lenses
- S75G2-470-W-LPI** S75G2, 470 nm Blue Wavelength, Wide Lenses, Linear Polarizer Installed.

Line lens optic not available for UV wavelengths.
Additional wavelengths and lens options available upon request.





This light is available in our SWIR LEDs.



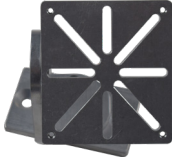

ACCESSORIES

Power Cables	
	
Length	Part Number
5 m	5PM12-5
10 m	5PM12-10
15 m	5PM12-15

Mount	
	
Description	Part Number
Pan and Tilt Mount	PB75-M5

Linear Polarizer	
	
Description	Part Number
Linear Polarizer for S75G2	S75-LP

Diffuser	
	
Description	Part Number
Diffuser Kit for S75G2	S75-DKIT

SmartVisionLink™	
	
Part Number	Description
BTM-1000	Bluetooth Module

PRODUCT DRAWINGS

*CAD files available on our website
Drawings are in mm

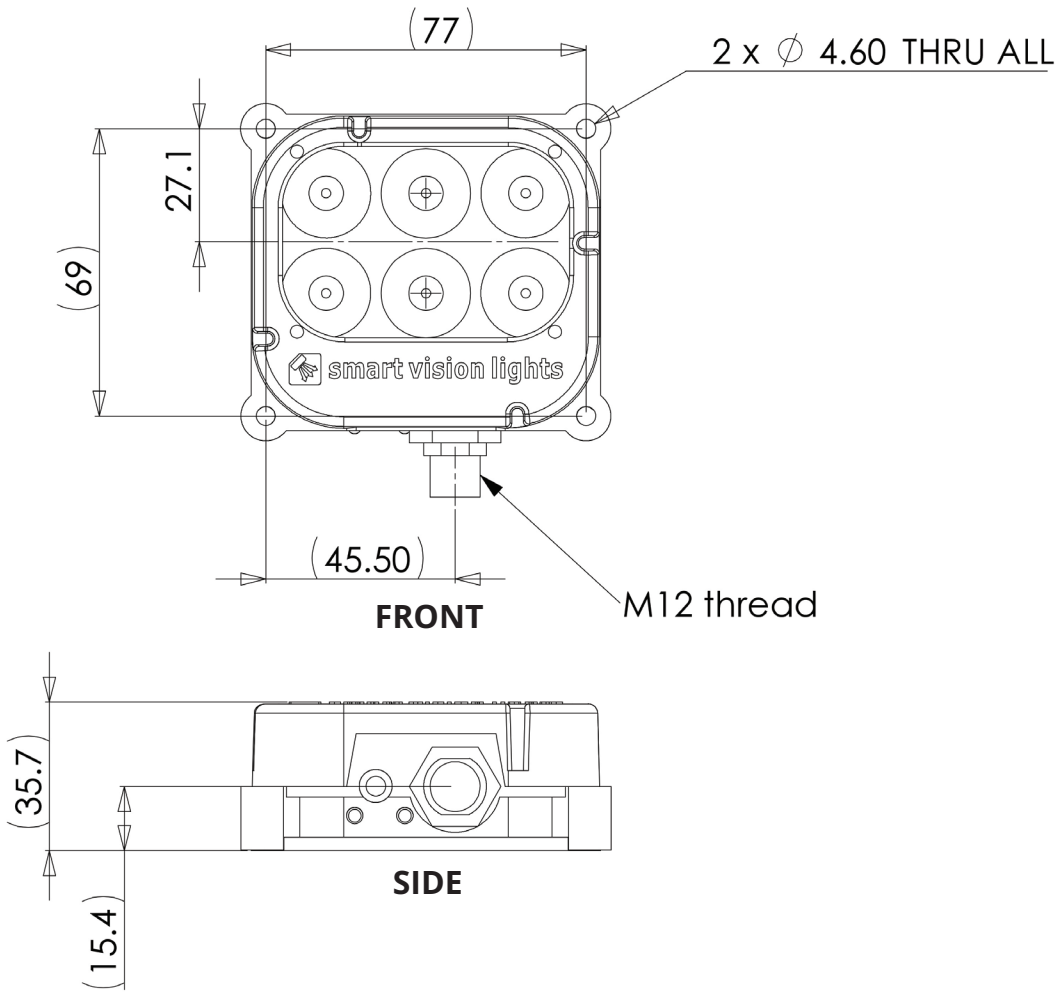

GLOSSARY

This glossary covers all Smart Vision Lights product families; some content in this section may not apply to this specific light.

TERMINOLOGY

Continuous Operation The light stays on continuously.

OverDrive™ Integrated driver that produces a high-current strobe to the LEDs to drive them beyond their nominal continuous operation output.

Multi-Drive™ Integrated driver that combines continuous operation and OverDrive™ strobe mode

NanoDrive™ Integrated driver that provides fast switching where the light can go from off to on in less than 500 ns.

Built-in Driver The driver contained within the light that controls the current to the LEDs and provides PNP, NPN, and analog dimming controls.

SmartVisionLink™ Integrated feature that enables lighting control through the Bluetooth module and app.

Camera to Light Connect the light directly to the camera, without the need for additional controllers or equipment.

Polarizers Filters that reduce reflections on specular surfaces.

Diffusers Widens the angle of emission by scattering light in all directions.

Pattern Area Lighting Modulated lighting pattern placed over a backlight's surface used to enhance defect detection on transparent and glossy surfaces

SafeStrobe Limiter to keep the light in safe working parameters.

Direct Connect Connect lights in a series without the use of cables.

Daisy-Chain Connect lights in a series with the use of cables.

TYPES OF ILLUMINATION

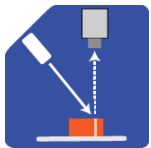

Projector

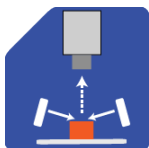

Dark Field

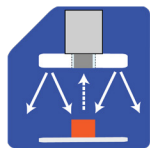

Radial



Bright Field

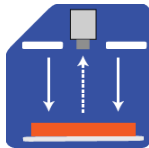

Direct

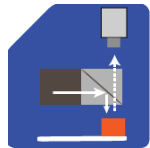

Axial

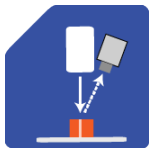

Line

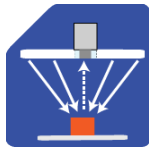

Diffuse Panel

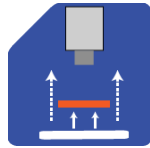

Backlight



Dome
"Light Tent"

COMMON COLOR / WAVELENGTHS LEGEND

Wavelengths options range from 365 nm to 1650 nm.*
Additional wavelengths available for many light families.

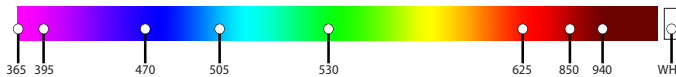

*See Part Number section for **this light's** available standard wavelengths.



Shortwave Infrared LEDs are available in 1050 nm, 1200 nm, 1300 nm, 1450 nm, 1550 nm, and 1650 nm.*

*Check Part Number section to see if **this light** is available in SWIR wavelengths.



ISO 9001:2015 Certified QMS