

OverDRIVE

Warranty
10
YEAR

Compliant
IEC
62471

Compliant
CE
RoHS

Rated
IP
50

Connector
5-PIN
M12

PRODUCT HIGHLIGHTS

- ✓ OverDrive™ — Up to five times brighter than a standard Large Area Ring Light .
- ✓ 5-pin M12 quick connect
- ✓ Built-in driver, no external wiring needed
- ✓ PNP and NPN strobe input
- ✓ Conversion adapters for different cameras



PRODUCT DESCRIPTION

The all metal construction of the Ring Light Series of lights provides a small particle resistant and all around durable light. Its simple plug and play 5-pin M12 connector allows for ease of use while allowing for full control. The ODRL200 operates with either an NPN or a PNP signal and runs on an industry standard 24VDC. The 1-10V DC intensity control assists in gaining full control of the light output. A standard 42 mm inner hole diameter allows for use with nearly all camera systems with available step-up and step-down conversion kits adapters.



PRODUCT SPECIFICATIONS

Electrical Input	24 V DC +/- 5%
Input Current	Max. 300 mA
Wattage	Max. 7.5 W
On / Off Input	PNP > +4 V DC or greater to activate NPN > GND (<1 V DC) to activate
PNP Line	4 mA @ 4 V DC 10 mA @ 12 V DC 20 mA @ 24 V DC
NPN Line	15 mA @ Ground (0V DC)
Yellow Indicator LED	LED Strobe Indicator ON = Light Active
Green Indicator LED	ON = Power
Continuous Mode	NPN can be tied to ground OR PNP can be tied to 24 V DC (not both)
Potentiometer	270° turn pot – Intensity control of 10% to 100%. Turn clockwise to increases intensity
Analog Intensity	The output is adjustable from 10–100% of brightness by a 1–10 V DC signal. (Jumpering pin 5 to pin 1 will provide maximum intensity)
Connection	5-pin M12 connector
Ambient Temperature	-18°–40° C (0°–104° F)
IP Rating	IP50
Weight	~1570g
Compliances	CE, RoHS, IEC-62471



WIRING CONFIGURATION

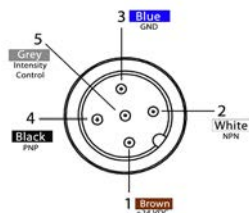

Pin layout for light (Male Connector)

Pins	Function	Signal	Wire Color
1	Power In	+24 V DC	BROWN
2	NPN	Sinking Signal	WHITE
3	GND	Ground	BLUE
4	PNP	Sourcing Signal	BLACK
5	Intensity Control	1 - 10 V DC	GREY*

* Some cables use green/yellow for pin 5

For maximum intensity, it is possible to tie pin 5 to pin 1 at +24 V DC.

For continuous mode: PNP (pin 4) can be tied to +24 V DC (pin 1) **OR** NPN (pin 2) can be tied to Ground (pin 3).

OPTIONAL

For maximum intensity, analog intensity may be connected to +V DC (24 V DC) - Jumper pin 5 to pin 1

RESOURCE CORNER

Additional resources are available on our website, including CAD files, videos, and application examples.

Smart Vision Lights

2359 Holton Road

Muskegon, MI 49445

P: +1 231.722.1199 | F: +1 231.722.9922

smartvisionlights.com

techsupport@smartvisionlights.com

Open: Monday – Friday | 8am–5pm ET





LIGHT PATTERNS

Smart Vision Lights recommends the ODRL200 be used at a working distance between 500 mm to 4000 mm.

Illumination measurement taken on White Light – 6500 K

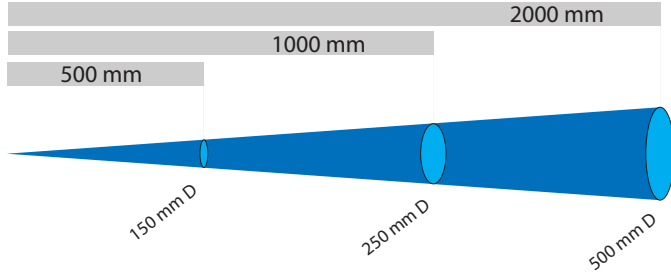

Illumination measurement taken on White Light – 6500 K

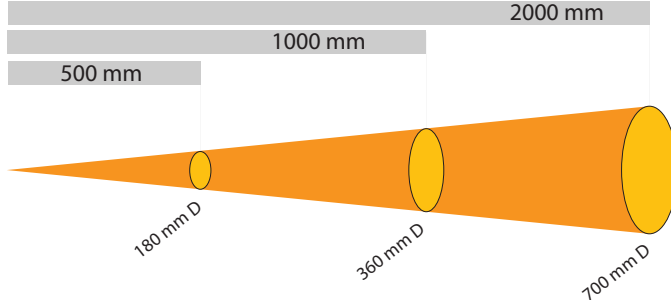

LIGHTING PATTERN FOR THE ODRL200

Working Distance mm (inches)	Pattern (80% - 100% measured intensity) mm (inches)
500 mm (19.7")	150 mm (5.9") D
1000 mm (39.4")	250 mm (9.8") D
2000 mm (78.8")	500 mm (19.6") D

Typical Output Performance	Illumination (Lux)
Distance = 500 mm	5500
<i>Illumination measurement taken on White Lights - 6500K</i>	

LIGHTING PATTERN FOR THE ODRL200 - 30° WIDE

Working Distance mm (inches)	Pattern (80% - 100% measured intensity) mm (inches)
500 mm (19.7")	180 mm (~7.1")
1000 mm (39.4")	360 mm (~14.1")
2000 mm (78.8")	700 mm (~27.5")

Typical Output Performance	Illumination (Lux)
Distance = 500 mm	9200
<i>Illumination measurement taken on White Lights - 6500K</i>	

The ODRL200 Ring Light produces a uniform light pattern.

Working Distance = 500 mm Grid set to 25 mm x 25 mm

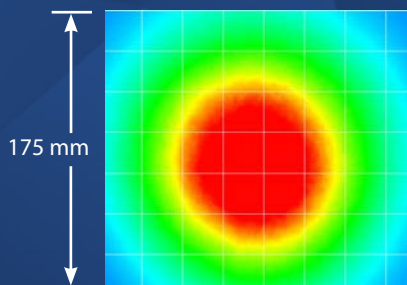

Narrow

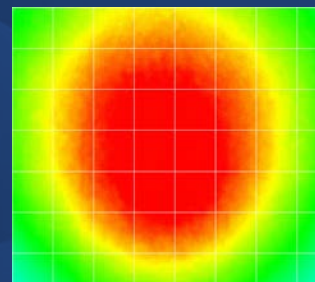

Wide

PRODUCT DRAWING

CAD files available on our website.
Dimensions are in mm.

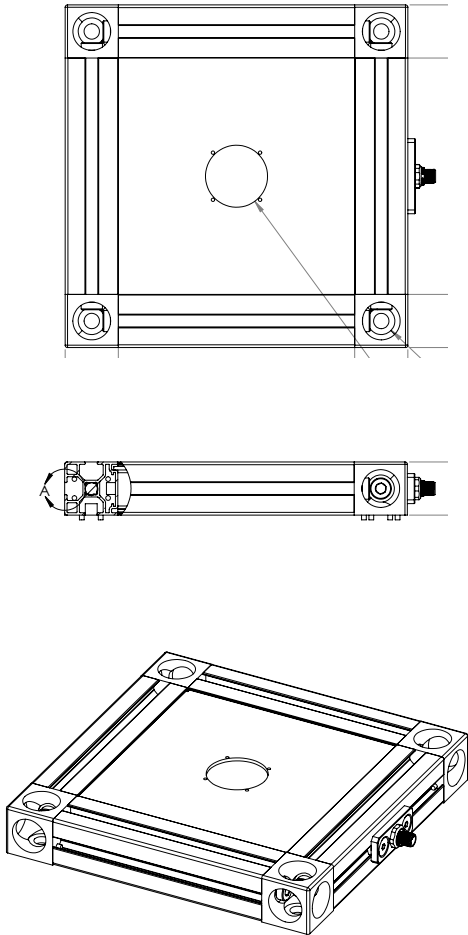

ILLUMINATION

ODRL200 Series of Ring Lights works best for:

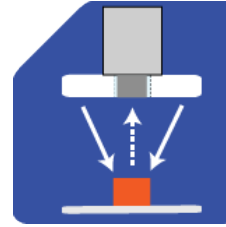

Radial

EYE SAFETY

According to IEC 62471:2006. Full documentation available upon request.



Notice

Exempt Group: No photobiological hazard to eyes or skin even for continuous, unrestricted use. Applicable for wavelengths: 625, 850, and 940.

Caution

Risk Group 1: Possibly hazardous optical radiation emitted from this product. Do not stare at operating lamp. May be harmful to eyes. Safe for most applications except prolonged exposure. Applicable for wavelengths: 470, 505, 530, and WHI.

Notice

Risk Group 1: UV emitted from this product. Minimize exposure to eyes and skin. Use appropriate shielding. Safe for most applications except prolonged exposures. Applicable for wavelengths: 395

Caution

Risk Group 2: UV emitted from this product. Eye or skin irritation may result from exposure. Use appropriate shielding. Does not pose optical hazard if aversion responses limit exposure. Applicable for wavelengths: 365



PART NUMBER

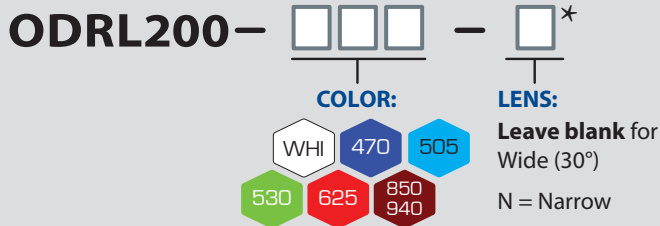

Part Number Examples:

- ODRL200-625** ODRL200, 625 Red Wavelength, Standard (Wide) Lenses
- ODRL200-WHI-N** ODRL200, White, Narrow Lenses

Additional wavelengths and lens options available upon request.



STANDARD LENS OPTICS

NARROW

Narrow, 14° angle cone lenses are standard. They project a narrow beam of illumination and are used for long working distances.

WIDE

Wide lenses are standard.

Wide, 30° angle cone lenses project a large area of illumination. They create a floodlight effect, can be used for short working distances.

** Additional lens options available upon request.*



MOUNTING

Mounting options include four T-slots and four M4 threaded holes on the ODRL200 ring light.

Optional Mounting Hardware:

T-Slots = M5 x 0.8 mm T-Nut

Threaded screw Holes = M4 screws

Camera Mount For ODRL200

Part #: BKT0005

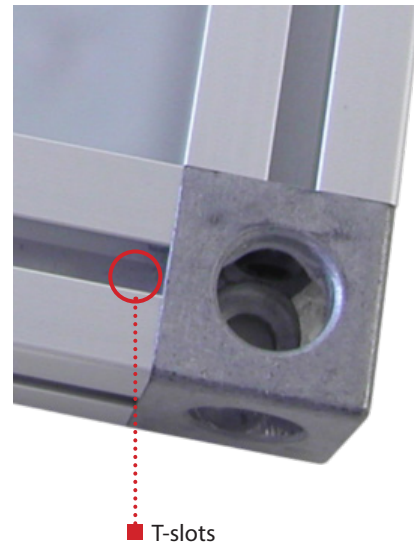



ACCESSORIES

Step-Up Kits *



Lens Thread Size	Part Number
25 mm	SU25.5-46
27 mm	SU27-46
30.5 mm	SU30.5-46
34 mm	SU34-46
35.5 mm	SU35.5-46
37 mm	SU37-46
39 mm	SU39-46
40.5 mm	SU40.5-46
43 mm	SU46-46

Step-Down Kits



Lens Thread Size	Part Number
49 mm	SD49-46
52 mm	SD52-46
55 mm	SD55-46
58 mm	SD58-46
62 mm	SD62-46
67 mm	SD67-46
72 mm	SD72-46

Power Cables



Lengths	Part Number
5 m	5PM12-5
10 m	5PM12-10
15 m	5PM12-15



GLOSSARY

This glossary covers all Smart Vision Lights product families; some content in this section may not apply to this specific light.

TERMINOLOGY

OverDrive™ Lights include an integrated high-pulse driver for complete LED light control.

Continuous Operation Lights stay on continuously.

Multi-Drive™ Combines continuous operation and OverDrive™ strobe (high-pulse operation) mode into one easy-to-use light.

Built-in Driver The built-in driver allows full function without the need of an external controller.

Camera to Light Connecting the light directly to the camera, without the need for additional controllers or equipment.

Polarizers Filters that reduce reflections on specular surfaces.

Diffuser Used to widen the angle of light emission, reduce reflections, and increase uniformity.

TYPES OF ILLUMINATION

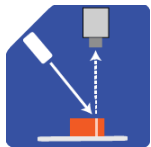

Projector

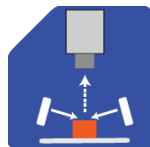

Dark Field

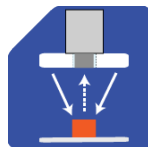

Radial



Bright Field

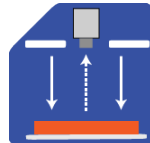

Direct

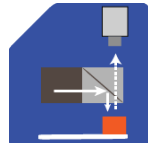

Axial

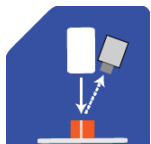

Line

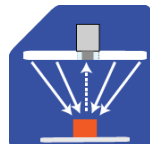

Diffuse Panel

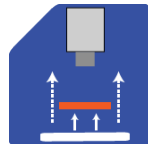

Backlight

COMMON COLOR/WAVELENGTHS LEGEND

Wavelengths options range from 365 nm to 1550 nm.*
Additional wavelengths available for many light families.

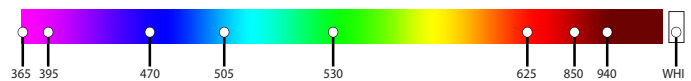

*See Part Number section for **this light's** available standard wavelengths.



Shortwave Infrared LEDs are available in 1050 nm, 1200 nm, 1300 nm, 1450 nm, and 1550 nm.*

*Check Part Number section to see if **this light's** is available in SWIR wavelengths.