

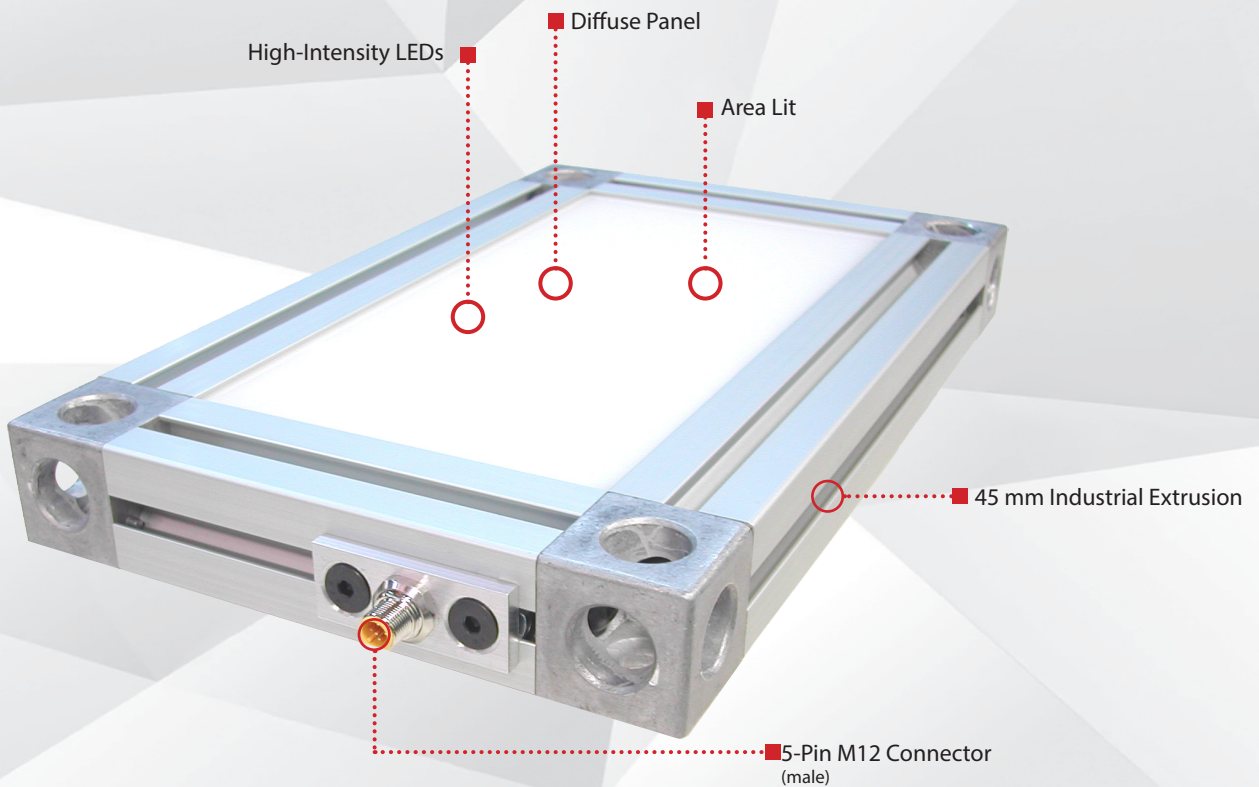

smart
vision lights

ODMOBL *Maximum Output* BACKLIGHT OVERDRIVE

P R O D U C T D A T A S H E E T



Warranty	Compliant	Compliant	Rated	Connector
10 YEAR	IEC 62471	CE RoHS	IP 50	5-PIN M12

PRODUCT HIGHLIGHTS

- ✓ OverDrive™ — Five times brighter than a standard Maximum Output Backlight (MOBL)
- ✓ Built-in driver
- ✓ PNP and NPN trigger signal input
- ✓ 45mm industrial extrusion for mounting
- ✓ 5-pin M12 quick connect
- ✓ Custom sizes available





PRODUCT DESCRIPTION

The ODMOBL Backlight Series is designed for maximum output. NPN or PNP trigger signals can be used to control the pulse of the light. Intensity of the light can be controlled via 1–10VDC analog signal line. Proper heat dissipation is achieved using the side extrusion and the heat sink installed on the bottom of the light. The 45 mm extrusion makes mounting the light easy when using drop-in T-nuts. The ODMOBL Backlight has a built-in driver. No external driver is required.



PRODUCT SPECIFICATIONS

Electrical Input	24VDC +/-5%
Strobe Input	PNP: +4VDC to +24VDC to activate NPN: GND (<1VDC) to activate
PNP Line	4 mA @ 4VDC 10 mA @ 12VDC 20 mA @ 24VDC
NPN Line	15 mA @ Ground (0VDC)
Analog Intensity	The output is adjustable from 10%–100% of brightness by a 1–10VDC analog signal line. For maximum intensity, use +24VDC. Jumpering pin 5 to pin 1 will provide maximum intensity.
Strobe/Pulse Time	Max. 5000 SPS (Strobes Per Second) Max. Single Pulse = 125 ms (see SafeStrobe™ Technology for more information)
Duty Cycle	Max. 10%
Connection	5-pin M12 connector
Ambient Temperature	-18°–40°C (0°–104°F)
IP Rating	IP50
Compliances	CE, RoHS, IEC 62471
Warranty	10 years. For complete warranty information, visit smartvisionlights.com/warranty .

Standard Light Sizes	Input Current	Wattage	Weight
150 mm x 150 mm	1.1 A	26.4 W	~2.22 kg
300 mm x 150 mm	2.2 A	52.8 W	–
300 mm x 300 mm	4.4 A	106 W	–



WIRING CONFIGURATION

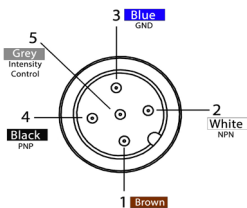

Pin layout for light (Male Connector)

Pin	Function	Signal	Wire Color
1	Power In	+24VDC	BROWN
2	NPN	Sinking Signal	WHITE
3	GND	Ground	BLUE
4	PNP	Sourcing Signal	BLACK
5	Intensity Control	1–10VDC	GREY*

*Some cables use green/yellow for pin 5.

For maximum intensity, tie pin 5 to pin 1 at +24V DC.

For continuous mode, PNP (pin 4) can be tied to +24V DC (pin 1) or NPN (pin 2) can be tied to Ground (pin 3).

OPTIONAL

For maximum intensity, connect pin 5 to pin 1 at 24VDC.

Otherwise intensity is adjustable via the 1–10VDC analog control line.



MULTIPLE CONNECTORS

Some ODMOBL backlights have multiple connectors. Each of these connectors are independent and are wired separately of each other.



RESOURCE CORNER

Additional resources, including CAD files, videos, and application examples, are available on our website.

PRODUCT DRAWING

CAD files available on our website.
Dimensions are in mm.

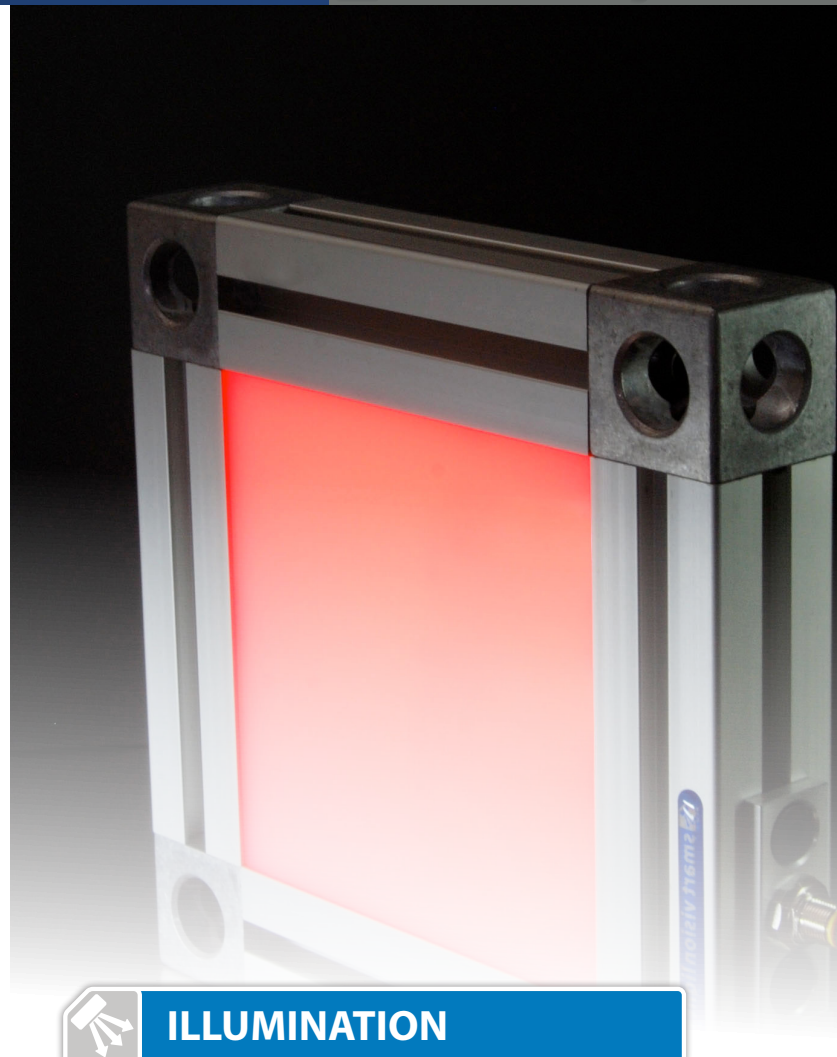
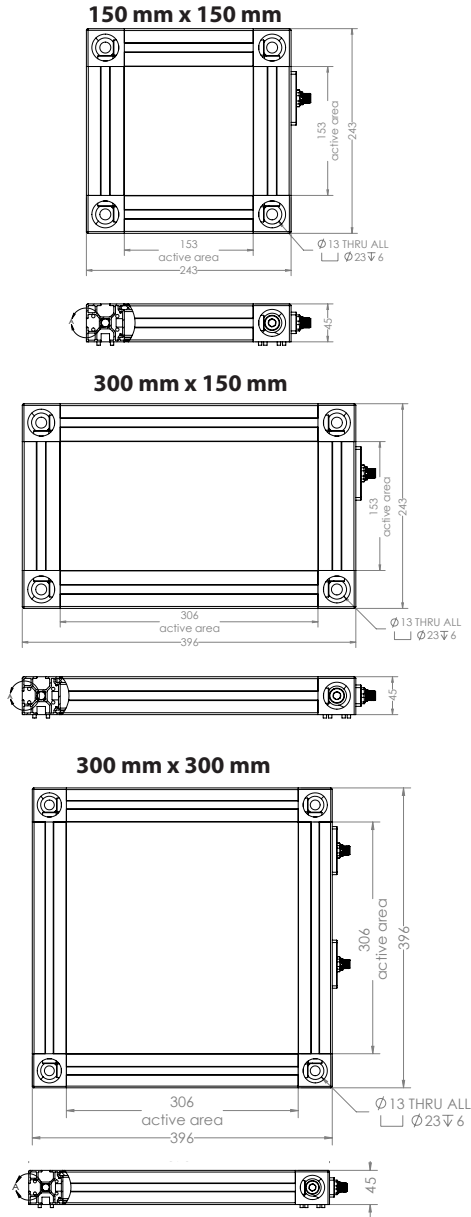

ILLUMINATION

ODMOBL Series of Backlights works best for:

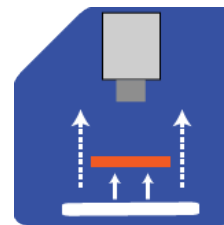

Backlight

EYE SAFETY

According to IEC 62471:2006. Full documentation available upon request.



Notice

Exempt Group: No photobiological hazard to eyes or skin even for continuous, unrestricted use. Applicable for wavelengths 625, 850, 940, 1050, 1200, 1300, 1450, and 1550.

Caution

Risk Group 1: Possibly hazardous optical radiation emitted from this product. Do not stare at operating lamp. May be harmful to eyes. Safe for most applications except for prolonged exposure. Applicable for wavelengths 470, 505, 530, and WHI.

PART NUMBER

ODMOBL - X - - X -

SIZE (L x W):
 150 x 150
 300 x 150
 300 x 300
 Custom sizes upon request

COLOR:

PATTERN AREA LIGHTING*:
 Leave blank for no pattern

Part Number Examples:

ODMOBL-150x150-625 ODMOBL 150 x 150 mm, 625 nm Red Wavelength

ODMOBL-300x150-WHI-105x05 ODMOBL 300 x 150 mm, white, Patterned Area Light with 5 mm dark line, 5 mm light gap, no gradient

ODMOBL-300x300-WHI-215x15-10 ODMOBL 300 x 300 mm, white, Patterned Area Light with 15 mm grid (dark lines), 15 mm light gap and 10% gradient

PATTERN AREA LIGHTING:

TYPE	DARK LINE	LIGHT GAP	GRADIENT
1 - Line	01 - 1 mm	01 - 1 mm	Leave blank for no gradient
2 - Grid	02 - 2 mm	02 - 2 mm	10 - 10%
	05 - 5 mm	05 - 5 mm	15 - 15%
	10 - 10 mm	10 - 10 mm	20 - 20%
	15 - 15 mm	15 - 15 mm	25 - 25%
	20 - 20 mm	20 - 20 mm	50 - 50%
	25 - 25 mm	25 - 25 mm	

Dark Line - Printed dark line size in millimeters
 Light Gap - Light gap width in millimeters
 Gradient - Percentage of dark line to be gradient

The 5-pin M12 connector is located on the wide side of the light.
 Sizes listed are in millimeters.
 Additional wavelengths and sizes available upon request.

OPTICAL PERFORMANCE

The ODMOBL offers a very diffuse light pattern.

OPTICAL PERFORMANCE FOR THE ODMOBL

Rating	Illuminance (Lux)
Average Intensity Rating	350,000

Illuminance measurement taken at surface of ODMOBL

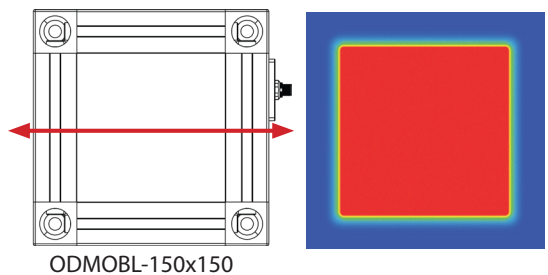

DUTY CYCLE

The duty cycle (D) is related to the strobe time (ST) and rest time (RT).

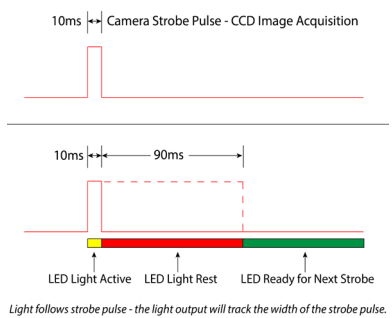

Calculating Rest Time

$$RT = \frac{ST}{D} - ST$$

RT = Rest Time
 ST = Strobe Time
 D = Duty Cycle

Example

$$90 \text{ ms} = \frac{10 \text{ ms}}{.1} - 10 \text{ ms}$$

Rest Time is 90 ms for 10 ms Strobe Time

Calculating Strobe Rate

$$SR = \frac{D}{ST}$$

SR = Strobe Rate (strokes per second)
 ST = Strobe Time (seconds)
 D = Duty Cycle

Example

$$1000 = \frac{0.1}{0.0001}$$

Strobe Rate is 1000 strokes per second

Calculating Duty Cycle

$$D = ST \times SR$$

SR = Strobe Rate (strokes per second)
 ST = Strobe Time (seconds)
 D = Duty Cycle

Example

$$0.1 = 0.0001 \times 1000$$

Duty Cycle is 10% (0.1)

Maximum duty cycle for OverDrive™ light is 10% (0.1)
 Note: Strobe time is limited by the strobe rate.

PATTERNED AREA LIGHTING™

Patterned Area Lighting (PAL) is used for isolating defects on uneven, highly specular, and/or clear surfaces, which can be difficult with standard lighting methods. PAL can be used to isolate a defect in a single image acquisition. With PAL, small defects will reflect off the surface at an equal but opposite angle. Distortion of the reflected image can also reveal surface deformations.

How to use PAL

- For backlighting a transparent object, the light is positioned beneath the object.
- For front lighting, position the light where the light pattern will be directed on the surface at an angle.
- A camera is positioned to capture the reflection of the light source.
- The camera lens is adjusted to focus on the surface defect.
- The camera should also image the light source pattern, but the pattern does not need to be in tight focus.
- The depth of field for the lens should be adjusted to include both the light source pattern and the defect in one im-

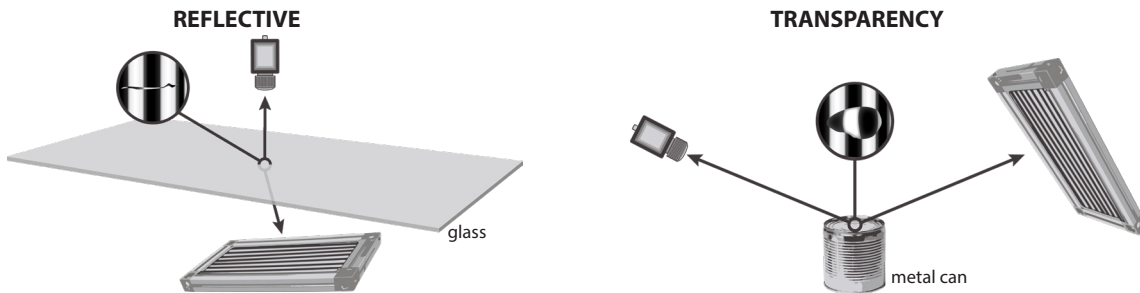

Patterned Area Lighting Examples

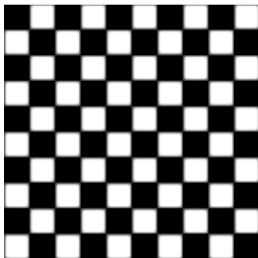

Pattern: Checker Board
Size: 50 mm x 50 mm square

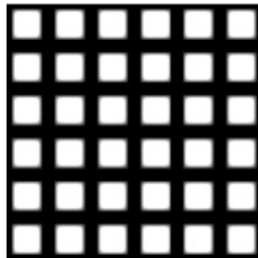

Grid
50 mm line width

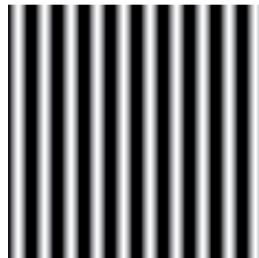

Gradient Lines
50 mm line width

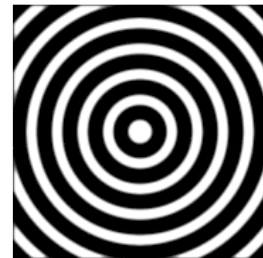

Circles
50 mm circle thickness

Customized pattern sizes available upon request.

NOTE

Smart Vision Lights can customize just about any pattern needed to meet application requirements.

MOUNTING

Smart Vision Lights recommends using **drop-in T-nuts** for mounting a ODMOBL Backlight. The ODMOBL extrusion has a Bosch size 10 T-nut channel.

NOTE

Removing corner cubes of light may result in voiding of warranty.

Bosch size 10 T-nut channel

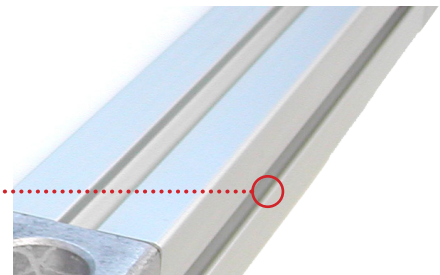

AREA LIT

LEDs are placed to disperse light evenly throughout the lighted surface.

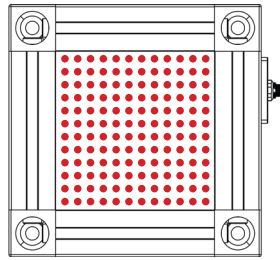

ODMOBL-150 x150 shown
(LED size and spacing not shown to scale)

SAFESTROBE™ TECHNOLOGY

SafeStrobe™ technology applies safe working parameters to ensure that high-current LEDs are not damaged by being driven beyond their limits, such as maximum strobe time or duty cycle. This is especially beneficial for overdriving our high-current LEDs.

CUSTOM SIZE

Smart Vision Lights can customize a ODMOBL to the size you need. When requesting a custom ODMOBL include the following: size (length x width) in millimeters, what side the 5-pin M12 connector should be placed on, and desired wavelength (color).

ACCESSORIES

Power Cables

Length	Part Number
5 m	5PM12-5
10 m	5PM12-10
15 m	5PM12-15

GLOSSARY

This glossary covers all Smart Vision Lights product families; some content in this section may not apply to this specific light.

TERMINOLOGY

OverDrive™ Lights include an integrated high-pulse driver for complete LED light control.

Continuous Operation Lights stay on continuously.

Multi-Drive™ Combines continuous operation and OverDrive™ strobe (high-pulse operation) mode into one easy-to-use light.

Built-In Driver The built-in driver allows full function without the need of an external controller.

Camera to Light Connecting the light directly to the camera, without the need for additional controllers or equipment.

Polarizers Filters that reduce reflections on specular surfaces.

Diffuser Used to widen the angle of light emission, reduce reflections, and increase uniformity.

TYPES OF ILLUMINATION

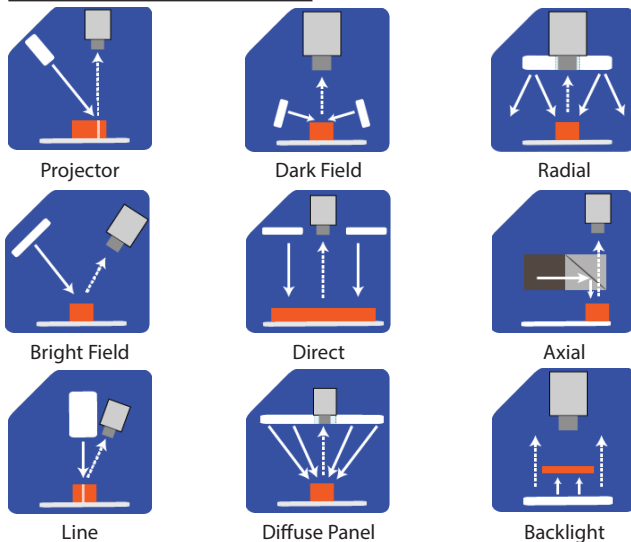

COMMON COLOR/WAVELENGTHS LEGEND

Wavelength options range from 365 nm to 1550 nm. Additional wavelengths available for many light families.

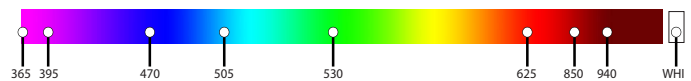

See Part Number section for **this light's** available standard wavelengths.



Shortwave infrared LEDs are available in 1050 nm, 1200 nm, 1300 nm, 1450 nm, and 1550 nm.

Check Part Number section to see if **this light** is available in SWIR wavelengths.