

### P R O D U C T D A T A S H E E T

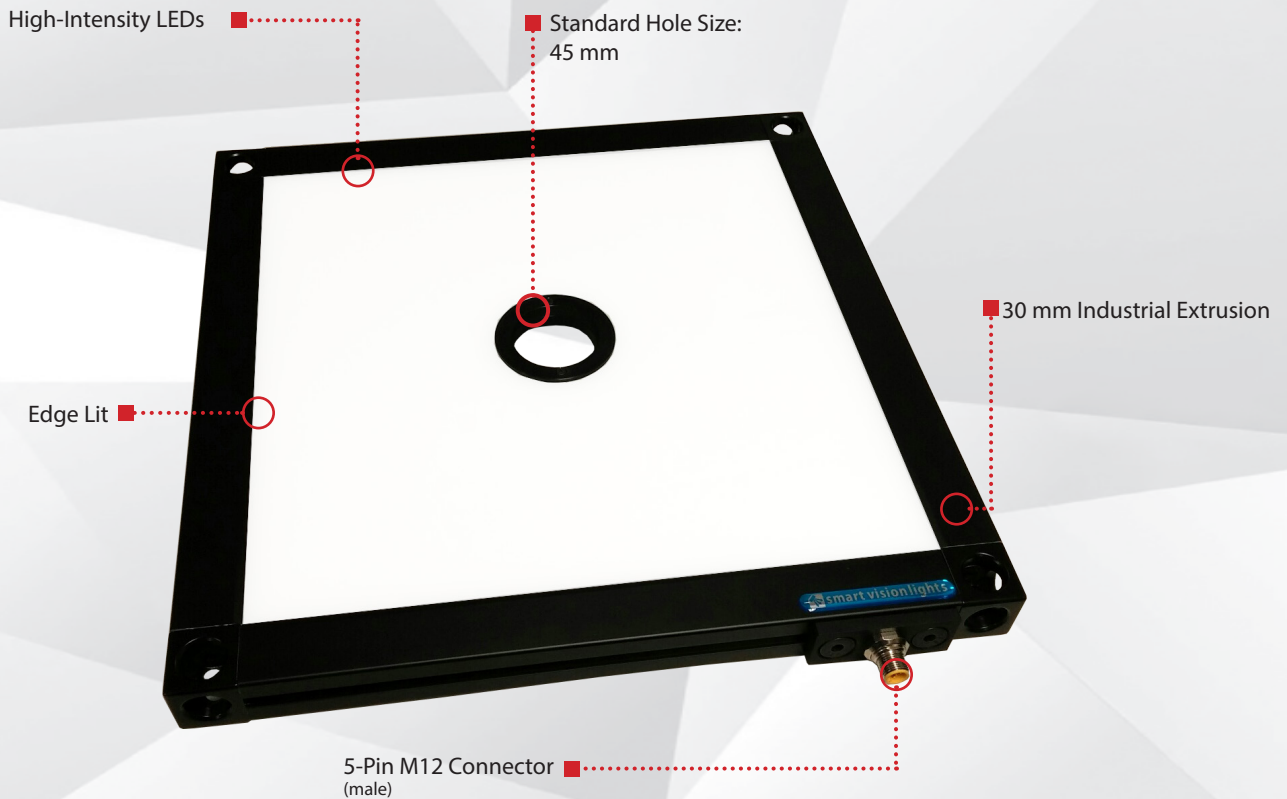

Warranty  
**10**  
YEAR

Compliant  
**IEC**  
62471

Compliant  
**CE**  
RoHS

Rated  
**IP**  
**50**

Connector  
**5-PIN**  
**M12**

## PRODUCT HIGHLIGHTS

- ✓ Built-in driver
- ✓ PNP and NPN trigger signal input
- ✓ 30 mm industrial extrusion
- ✓ 5-pin M12 quick connect
- ✓ Custom light sizes available
- ✓ Custom hole placement and sizing available



## PRODUCT DESCRIPTION

In the LLPX-H Light Panel Series, an optically clear internal light dispersion grid and a matte-white-finished backing plate allow more light to be reflected up and out through the diffusion acrylic. The LLPX-H features Multi-Drive™, which allows the user to operate the light in constant ON operation or OverDrive™, depending on wiring method. The industry-standard 5-pin M12 connector makes for simple wiring. The 1–10VDC analog signal line gives the user total control over intensity in continuous operation. Removing the signal puts the light into OverDrive™ strobe mode. Custom placement, sizing, and number of holes available upon request.



## PRODUCT SPECIFICATIONS

	CONTINUOUS OPERATION	OVERDRIVE™ STROBE MODE
Electrical Input	24VDC +/-5%	
PNP Line	4 mA @ 5VDC   8 mA @ 10VDC   15 mA @ 24VDC	
NPN Line	15 mA @ ground (0VDC)	
OverDrive™ Strobe Mode	<b>Not applicable</b>	Connect pin 5 to GND (see Wiring Configuration for more information)
Strobe Duration	<b>Not applicable</b>	Min. 10 μs   Max. 50 ms (see SafeStrobe™ Technology for more information)
Duty Cycle	<b>Not applicable</b>	Max. 10%
Strobe Input	<b>Not applicable</b>	PNP: +4VDC or greater to activate NPN: GND (<1VDC) to activate
Continuous Operation Mode	NPN can be tied to ground <b>OR</b> PNP can be tied to 24VDC (not both)	<b>Not applicable</b>
On/Off Input	PNP: +4VDC or greater to activate NPN: GND (<1VDC) to activate	<b>Not applicable</b>
Connection	5-pin M12 connector	
Ambient Temperature	-18°–40° C (0°–104° F)	
IP Rating	IP50	
Compliances	CE, RoHS, IEC 62471	
Warranty	10 year warranty. For complete warranty information, visit <a href="http://smartvisionlights.com/warranty">smartvisionlights.com/warranty</a> .	

Standard Light Sizes	Input Current	Wattage	Weight
306 mm x 306 mm	1.26 A	30.24 W	~3.08 kg
459 mm x 459 mm	1.98 A	47.52 W	~5.74 kg



## CUSTOMIZE

Smart Vision Lights can customize an LLPX-H to meet your needs.

### Size

SVL can customize an LLPX-H to the size you need — up to 4800 x 1180 mm. When requesting a custom LLPX-H, include the following: size (length x width) in millimeters, what side the 5-pin M12 connector should be placed on, and desired wavelength (color).

### Holes

Holes can be placed in just about any location on the LLPX-H. When requesting custom hole placement, include number of holes needed, size of holes in millimeters and desired locations.



## RESOURCE CORNER

Additional resources, including CAD files, videos, and application examples, are available on our website.



## WIRING CONFIGURATION

### CONTINUOUS OPERATION MODE

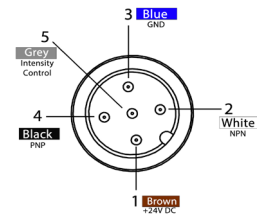

Pin layout for light (male connector)

Pin	Function	Signal	Wire Color
1	Power In	+24VDC	BROWN
2	NPN	Sinking Signal	WHITE
3	GND	Ground	BLUE
4	PNP	Sourcing Signal	BLACK
5	Intensity Control	1-10VDC	GREY*

\*Some cables use green/yellow for pin 5.

For maximum intensity tie pin 5 to pin 1 at +24 VDC.

For continuous mode, PNP (pin 4) can be tied to +24 VDC (pin 1) or NPN (pin 2) can be tied to ground (pin 3).

For the light to function properly, apply either a PNP or NPN signal, not both.

Failure to supply light with correct input current will result in non-repeatable lighting.  
(see Product Specifications for requirements)

### OVERDRIVE™ OPERATION MODE

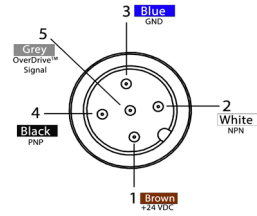

Pin layout for light (male connector)

Pin	Function	Signal	Wire Color
1	Power In	+24VDC	BROWN
2	NPN	Sinking Signal	WHITE
3	GND	Ground	BLUE
4	PNP	Sourcing Signal	BLACK
5	OverDrive™ Signal	Ground	GREY*

\*Some cables use green/yellow for pin 5.

For maximum intensity tie pin 5 to pin 1 at +24 VDC.

For continuous mode, PNP (pin 4) can be tied to +24 VDC (pin 1) or NPN (pin 2) can be tied to ground (pin 3).

Failure to supply light with correct input current will result in non-repeatable lighting.

(see Product Specifications for requirements)



## DUTY CYCLE (OVERDRIVE™ MODE ONLY)

This section applies only to OverDrive™ strobe mode.

The duty cycle (D) is related to the strobe time (ST) and rest time (RT).

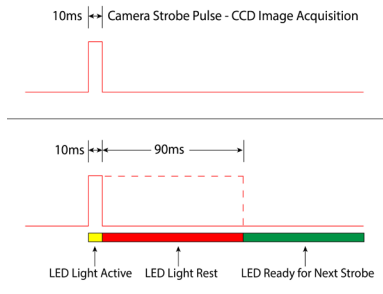

Light follows strobe pulse - the light output will track the width of the strobe pulse.

#### Calculating Rest Time

$$RT = \frac{ST}{D} - ST$$

RT = Rest Time  
ST = Strobe Time  
D = Duty Cycle

#### Example

$$90 \text{ ms} = \frac{10 \text{ ms}}{.1} - 10 \text{ ms}$$

Rest Time is 90 ms for 10 ms Strobe Time

#### Calculating Strobe Rate

$$SR = \frac{D}{ST}$$

SR = Strobe Rate (strokes per second)  
ST = Strobe Time (seconds)  
D = Duty Cycle

#### Example

$$1000 = \frac{0.1}{0.0001}$$

Strobe Rate is 1000 strokes per second

#### Calculating Duty Cycle

$$D = ST \times SR$$

SR = Strobe Rate (strokes per second)  
ST = Strobe Time (seconds)  
D = Duty Cycle

#### Example

$$0.1 = 0.0001 \times 1000$$

Duty Cycle is 10% (0.1)

Maximum duty cycle for OverDrive™ light is 10% (0.1)

Note: Strobe time is limited by the strobe rate.



## MULTI DRIVE

Multi-Drive™ offers the best of both worlds. Continuous operation and OverDrive™ mode (high-output strobe/pulse) are available in a single light. Other advantages of Multi-Drive™ include faster imaging and capture/freeze motion on high-speed lines.



The Multi-Drive™ feature allows the user to run the light continuously or in OverDrive™ at the maximum allowed intensity by simply setting the product configuration. OverDrive™ operation has **up to eight times** the power of continuous operation.



## EDGE LIT

The LLPX-H is edge lit, which means the light comes from each of the four edges. This produces a very homogeneous light output.

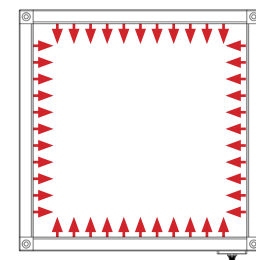

LLPX-459x459 shown (LED size and spacing not shown to scale)

## SAFESTROBE™ TECHNOLOGY

SafeStrobe™ technology applies safe working parameters to ensure that high-current LEDs are not damaged by being driven beyond their limits, such as maximum strobe time or duty cycle. This is especially beneficial for overdriving our high-current LEDs.

## PRODUCT DRAWING

CAD files available on our website.  
Dimensions are in mm.

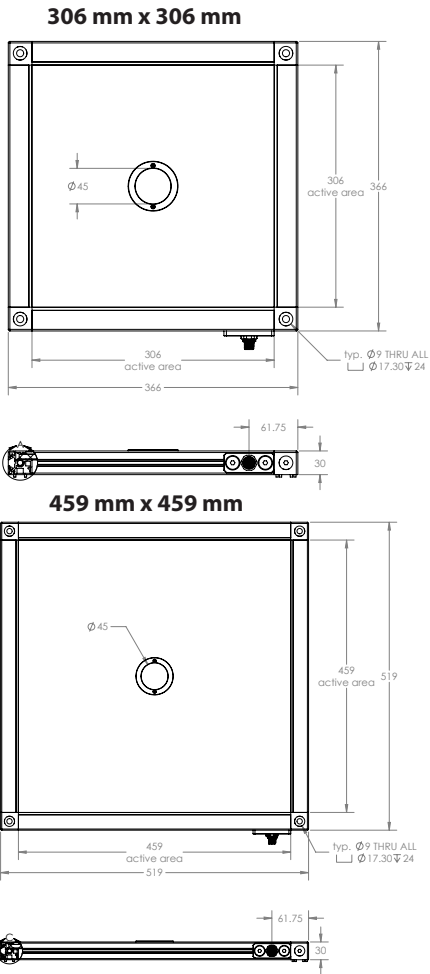

## ILLUMINATION

LLPX-H Series of Backlights works best for:

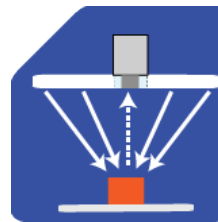

Flat Dome "Light Tent"

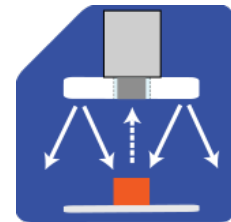

Radial

## EYE SAFETY

According to IEC 6247:2006. Full documentation available upon request.



### Notice

**Exempt Group:** No photobiological hazard to eyes or skin even for continuous, unrestricted use. Applicable for wavelengths 625, 850, 940, 1050, 1200, 1300, 1450, and 1550.

### Caution

**Risk Group 1:** Possibly hazardous optical radiation emitted from this product. Do not stare at operating lamp. May be harmful to eyes. Safe for most applications except for prolonged exposure. Applicable for wavelengths 470, 505, 530, and WHI.

## PART NUMBER

LLPX-H -  X  -  -  X  -

**SIZE (L x W):**  
 306 x 306  
 459 x 459  
 Custom sizes upon request

**COLOR:**

WHI 470  
 530 625

**PATTERN AREA LIGHTING™:**  
 Leave blank for no pattern

**Part Number Examples:**

<b>LLPX-H-306x306-625</b>	LLPX-H, 150 x 150 mm, 625 nm Red Wavelength
<b>LLPX-H-450x459-WHI</b>	LLPX-H, 300 x 150 mm, White
<b>LLPX-H-306x306-WHI-215x15-10</b>	LLPX-H, 450 x 150 mm, 470 nm Blue Wavelength, Pattern Area Light with 15 mm grid (dark lines), 15 mm light gap and 10% gradient

**PATTERN AREA LIGHTING:**

	<input type="text"/> <input type="text"/> <input type="text"/> X <input type="text"/> <input type="text"/> <input type="text"/>	-	<input type="text"/> <input type="text"/>
<b>TYPE</b>	<b>DARK LINE</b>	<b>LIGHT GAP</b>	<b>GRADIENT</b>
1 - Line	01 - 1 mm	01 - 1 mm	Leave blank for no gradient
2 - Grid	02 - 2 mm	02 - 2 mm	10 - 10%
	05 - 5 mm	05 - 5 mm	15 - 15%
	10 - 10 mm	10 - 10 mm	20 - 20%
	15 - 15 mm	15 - 15 mm	25 - 25%
	20 - 20 mm	20 - 20 mm	50 - 50%
	25 - 25 mm	25 - 25 mm	

Dark Line - Printed dark line size in millimeters  
 Light Gap - Light gap width in millimeters  
 Gradient - Percentage of dark line to be gradient

The 5-pin M12 connector is located on the wide side of the light.  
 Sizes listed are in millimeters.  
 Additional wavelengths and sizes available upon request.

## SIZING A LIGHT

When sizing a light for the most consistent/homogeneous illumination, best practice is to follow the W Rule. The W Rule states: The working distance (WD) is equal to the size of the part (X) and the size of the light is twice the size of the part.

**THE W RULE:**  
 The working distance is equal to the size of the part.  
 The size of the light is twice the size of the part.

If the working distances needs to be increases, the light also needs to increase in size to remain homogeneous.

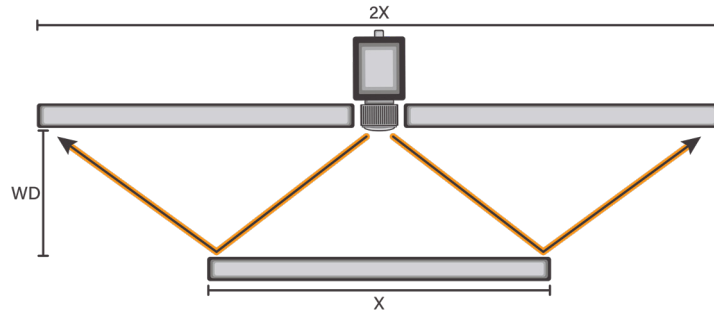

## OPTICAL PERFORMANCE

The LLPX-H offers a very diffuse light pattern.

**OPTICAL PERFORMANCE FOR THE LLPX-H**

Rating	Illuminance (Lux)
Average Intensity Rating	42,000
<i>Illuminance measurement taken at surface of LLPX-H</i>	

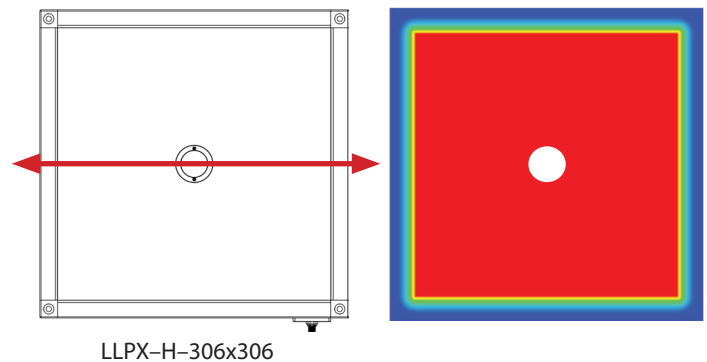



## MOUNTING

Smart Vision Lights recommends using **drop-in T-nuts** for mounting an LLPX-H backlight.

### Hardware included with light:

- (2) M5 x 10 mm screws (hex)
- (2) Drop-in T-nuts

#### NOTE

Removing corner cubes of light may result in voiding of warranty.



T-nut channel



## PATTERN AREA LIGHTING

Pattern Area Lighting (PAL) is used for isolating defects on uneven, highly specular, and/or clear surfaces, which can be difficult with standard lighting methods. PAL allows for isolating a defect in a single image acquisition. With PAL, small defects will reflect off the surface at an equal but opposite angle. Distortion of the reflected image can also reveal surface deformations.

### How to use PAL

- For backlighting a transparent object, the light is positioned beneath the object.
- For front lighting, position the light where the light pattern will be directed on the surface at an angle.
- A camera is positioned to capture the reflection of the light source.
- The camera lens is adjusted to focus on the surface defect.
- The camera should also image the light source pattern, but the pattern does not need to be in tight focus.
- The depth of field for the lens should be adjusted to include both the light source pattern and the defect in one im-

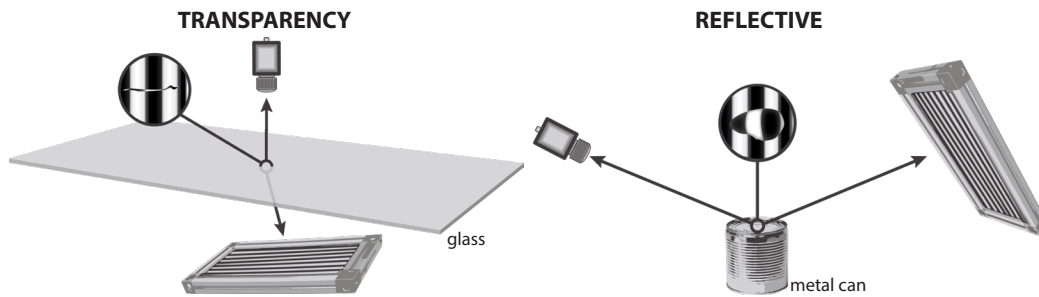

Pattern Area Lighting Examples

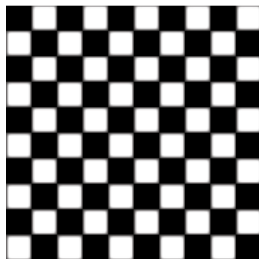

Pattern: Checker Board  
Size: 50 mm x 50 mm square

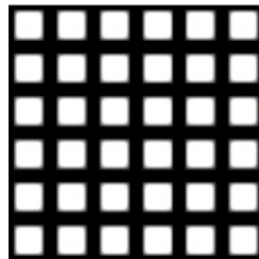

Grid  
50 mm line width

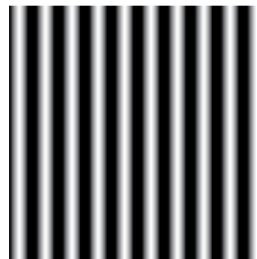

Gradient Lines  
50 mm line width

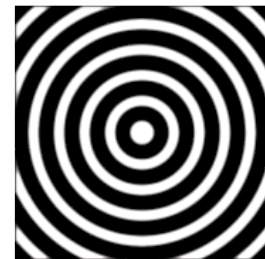

Circles  
50 mm circle thickness

Customized line and circle sizes available upon request.

#### NOTE

Smart Vision Lights can customize just about any pattern needed to meet application requirements.





## ACCESSORIES

Power Cables	
Length	Part Number
5 m	5PM12-5
10 m	5PM12-10
15 m	5PM12-15



## GLOSSARY

This glossary covers all Smart Vision Lights product families; some content in this section may not apply to this specific light.

### TERMINOLOGY

**OverDrive™** Lights include an integrated high-pulse driver for complete LED light control.

**Continuous Operation** Lights stay on continuously.

**Multi-Drive™** Combines continuous operation and OverDrive™ strobe (high-pulse operation) mode into one easy-to-use light.

**Built-In Driver** The built-in driver allows full function without the need of an external controller.

**Camera to Light** Connecting the light directly to the camera, without the need for additional controllers or equipment.

**Polarizers** Filters that reduce reflections on specular surfaces.

**Diffuser** Used to widen the angle of light emission, reduce reflections, and increase uniformity.

### TYPES OF ILLUMINATION

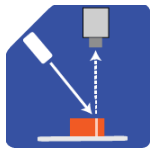

Projector

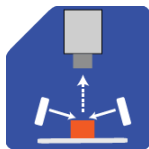

Dark Field

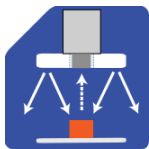

Radial



Bright Field

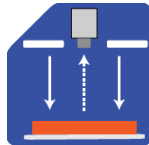

Direct

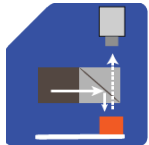

Axial

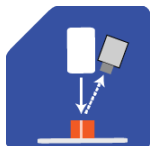

Line

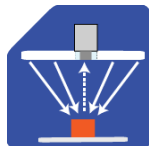

Diffuse Panel

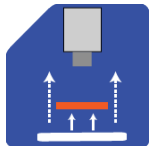

Backlight

### COMMON COLOR/WAVELENGTHS LEGEND

Wavelength options range from 365 nm to 1550 nm.  
Additional wavelengths available for many light families.

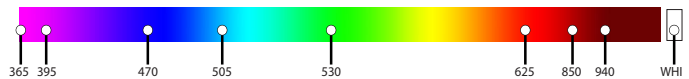

See Part Number section for **this light's** available standard wavelengths.



Shortwave infrared LEDs are available in 1050 nm, 1200 nm, 1300 nm, 1450 nm, and 1550 nm.

Check Part Number section to see if **this light** is available in SWIR wavelengths.