



smart
vision lights

DLP Diffuse Light Panel

RING LIGHT

P R O D U C T D A T A S H E E T

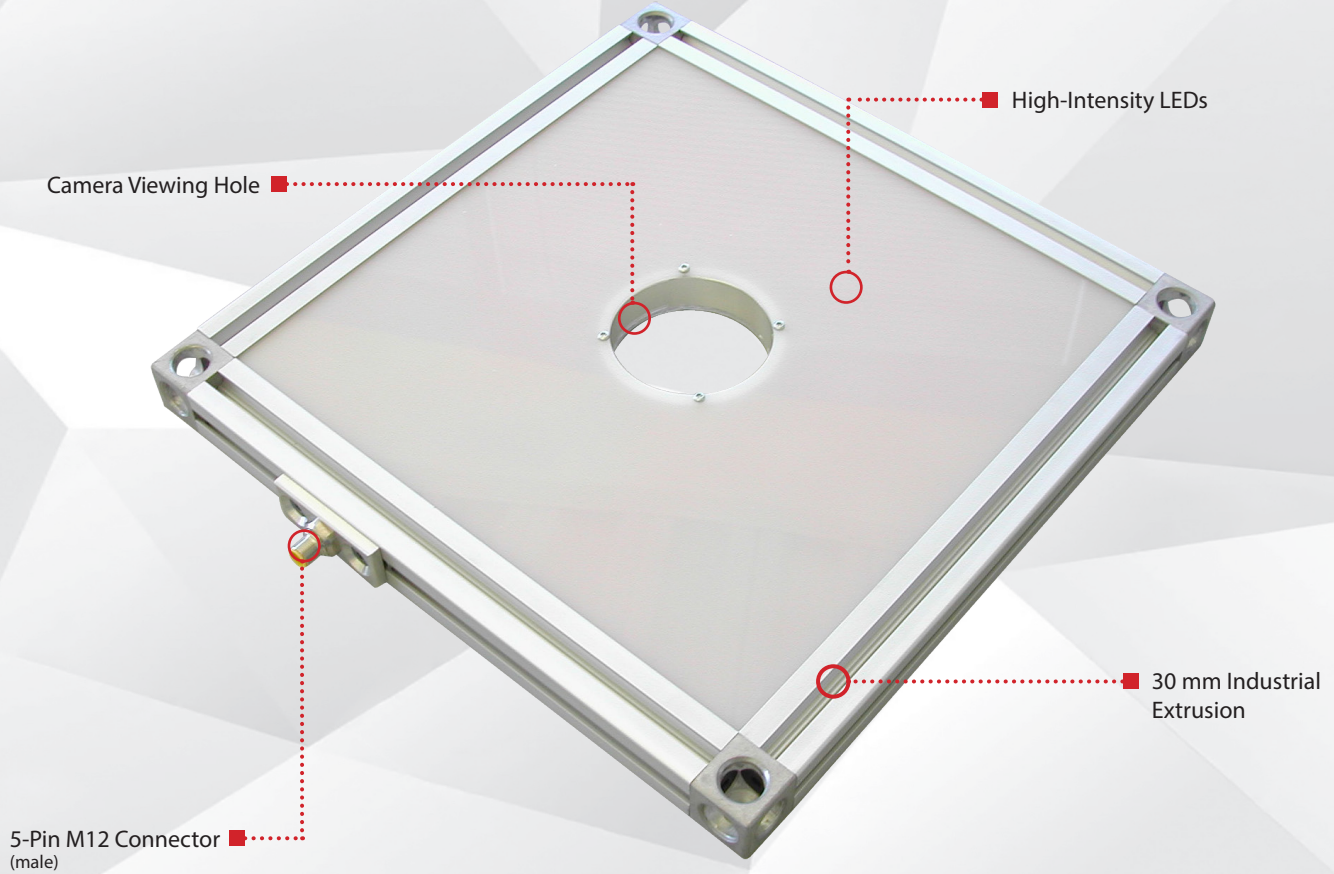

Warranty	Compliant	Compliant	Rated	Connector
10 YEAR	IEC 62471	CE RoHS	IP 50	5-PIN M12

* see page 2 for details.

PRODUCT HIGHLIGHTS

- ✓ 5-pin M12 quick connect
- ✓ Built-in driver
- ✓ PNP and NPN trigger signal input
- ✓ 30mm industrial extrusion
- ✓ Custom sizes available





PRODUCT DESCRIPTION

The DLP Diffused Panel Light Series is designed for front lighting. The innovative and highly versatile lights can be customized for different sizes and wavelength options. The series provides intense and highly diffuse area lighting. The narrow 30 mm depth allows for mounting in tight locations. The 190 x 190 mm lights have a 53 mm camera viewing hole in the center. Lights measuring 300 x 300 mm and larger have a 78 mm viewing hole.



PRODUCT SPECIFICATIONS

Electrical Input	24 V DC +/- 5%
On/Off Input	PNP: +4 V DC or greater to activate NPN: GND (<1 V DC) to activate
PNP Line	4 mA @ 4 V DC 10 mA @ 12 V DC 20 mA @ 24 V DC
NPN Line	15 mA @ ground (0V DC)
Continuous Mode	NPN can be tied to ground OR PNP can be tied to 24 V DC (not both)
Analog Intensity	The output is adjustable from 10–100% of brightness by a 1–10 V DC signal (Jumpering pin 5 to pin 1 will provide maximum intensity)
Connection	5-pin M12 connector
Ambient Temperature	-18°–40° C (0°–104° F)
IP Rating	IP50
Compliances	CE, RoHS, IEC 62471
Warranty	10 year warranty. For complete warranty information, visit smartvisionlights.com/warranty

Standard Light Sizes	Input Current	Wattage	Weight	Camera Hole
190 mm x 190 mm	1.25 A	30 W	~1.54 kg	53 mm
300 mm x 300 mm	1.8 A	43.2 W	~2.66 kg	78 mm
450 mm x 450 mm	4.1 A	98.4 W	~4.88 kg	78 mm
600 mm x 600 mm	3.6 A (per connector)	86.4 W (per connector)	-	78 mm



WIRING CONFIGURATION

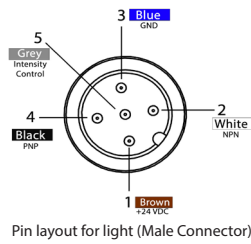

Pin	Function	Signal	Wire Color
1	Power In	+24 V DC	BROWN
2	NPN	Sinking Signal	WHITE
3	GND	Ground	BLUE
4	PNP	Sourcing Signal	BLACK
5	Intensity Control	1–10 V DC	GREY*

*Some cables use green/yellow for pin 5.
For maximum intensity, tie pin 5 to pin 1 at +24 V DC.
For continuous mode, PNP (pin 4) can be tied to +24 V DC (pin 1) **or** NPN (pin 2) can be tied to Ground (pin 3).

OPTIONAL

For maximum intensity, connect pin 5 to pin 1 at +24 V DC.

RESOURCE CORNER



Additional resources, including CAD files, videos, and application examples, are available on our website.

Smart Vision Lights

2359 Holton Road
Muskegon, MI 49445
P: +1 231.722.1199 | F: +1 231.722.9922
smartvisionlights.com
techsupport@smartvisionlights.com
Open: Monday – Friday | 8am–5pm ET



AREA LIT

LEDs are placed to produce uniform intensity throughout the lighted surface area.

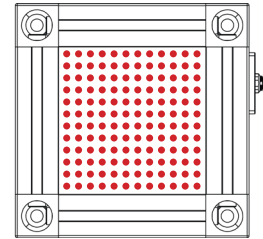

(LED size and spacing not shown to scale)



LIGHT PATTERNS

Smart Vision Lights recommends that the DLP be used at a working distance between 200 mm and 600 mm.

Beam Diameter (White Light)

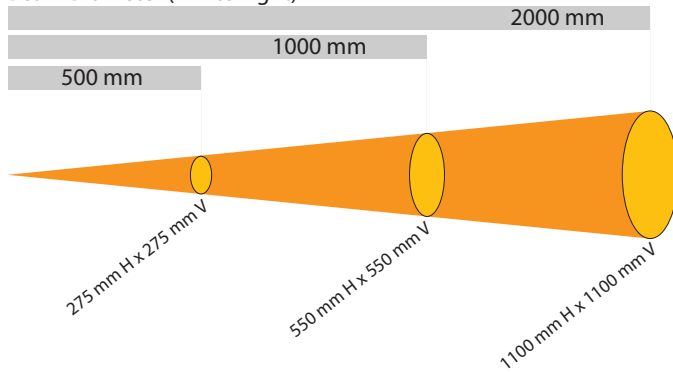

LIGHTING PATTERN FOR THE DLP-190x190

Working Distance mm (inches)	Pattern (80%–100% measured intensity) mm (inches)
500 mm (19.7")	80 mm (~3.1")
1000 mm (39.4")	90 mm (~3.54")
2000 mm (78.8")	135 mm (~5.3")

Typical Output Performance	Illuminance (Lux)
190 mm x 190 mm	44,000
<i>DLP-190x190-WHI used with a 500 mm working distance. Illumination measurement taken on White Lights – 5700K.</i>	

The DLP Ring Light produces a uniform light pattern.

Working distance = 500 mm Grid set to 25 mm x 25 mm

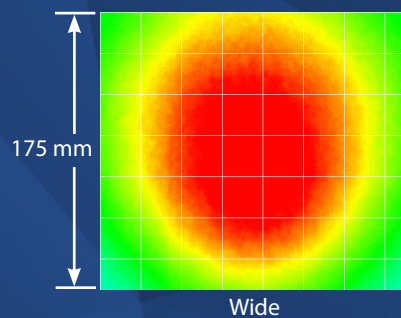

PRODUCT DRAWING

CAD files available on our website.
Dimensions are in mm.

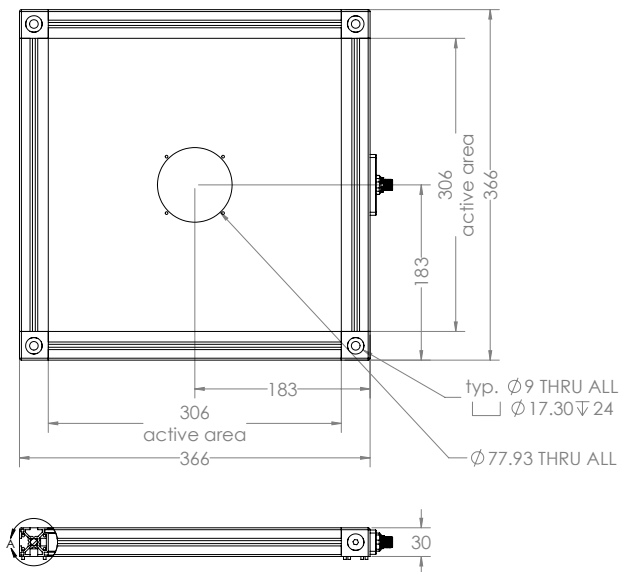

DPL 300 x 300 shown.
CAD files for all standard-size DLP lights are available at smartvisionlights.com.

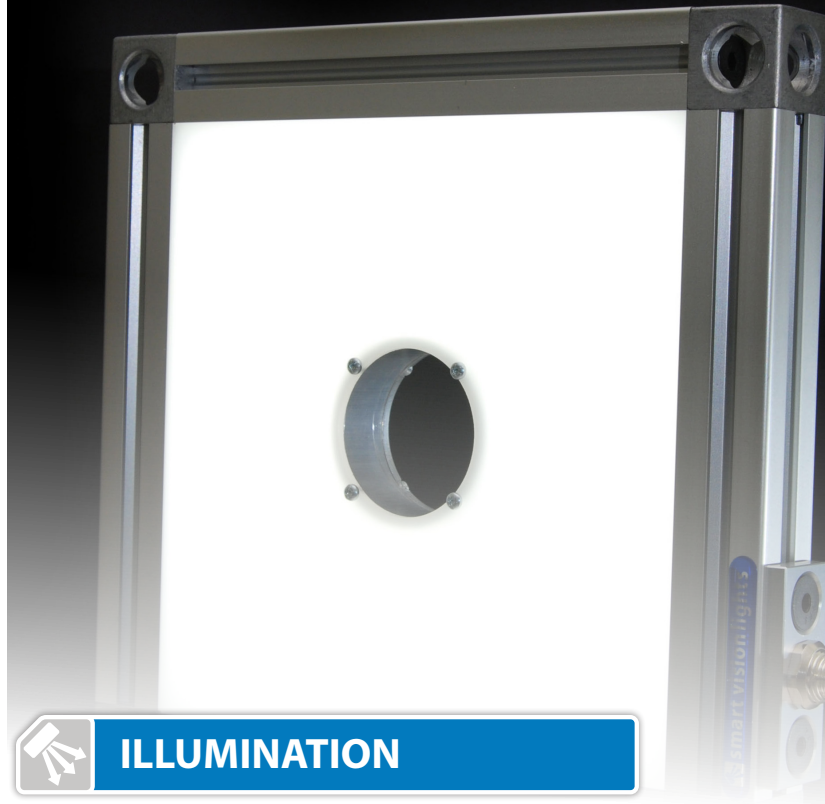

ILLUMINATION

DLP Series of Linear Lights works best for:

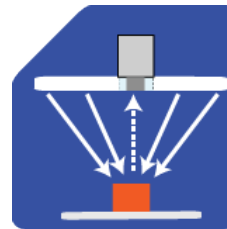

Diffuse Panel

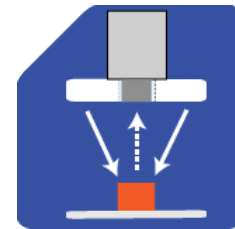

Radial

EYE SAFETY



According to IEC 62471:2006. Full documentation available upon request.

Notice

Exempt Group: No photobiological hazard to eyes or skin even for continuous, unrestricted use. Applicable for wavelengths 625, 850, and 940.

Caution

Risk Group 1: Possibly hazardous optical radiation emitted from this product. Do not stare at operating lamp. May be harmful to eyes. Safe for most applications except for prolonged exposure. Applicable for wavelengths 470, 505, 530, and WHI.

Notice

Risk Group 1: UV emitted from this product. Minimize exposure to eyes and skin. Use appropriate shielding. Safe for most applications except for prolonged exposures. Applicable for wavelength 395

Caution

Risk Group 2: UV emitted from this product. Eye or skin irritation may result from exposure. Use appropriate shielding. Does not pose optical hazard if aversion responses limit exposure. Applicable for wavelength 365



PART NUMBER

DLP - X - - X -

SIZE (L x W):

- 190 x 190
- 300 x 300
- 450 x 450
- 600 x 600

Custom sizes upon request

COLOR:



PATTERN AREA LIGHTING:
Leave blank for no pattern

PATTERN AREA LIGHTING:

X -

TYPE
1 - Line
2 - Grid

DARK LINE

- 01 - 1 mm
- 02 - 2 mm
- 05 - 5 mm
- 10 - 10 mm
- 15 - 15 mm
- 20 - 20 mm
- 25 - 25 mm

LIGHT GAP

- 01 - 1 mm
- 02 - 2 mm
- 05 - 5 mm
- 10 - 10 mm
- 15 - 15 mm
- 20 - 20 mm
- 25 - 25 mm

GRADIENT

- Leave blank for no gradient
- 10 - 10%
- 15 - 15%
- 20 - 20%
- 25 - 25%
- 50 - 50%

Dark Line - Printed dark line size in millimeters
Light Gap - Light gap width in millimeters
Gradient - Percentage of dark line to be gradient

The 5-pin M12 connector is located on the wide side of the light.
Sizes listed are in millimeters.
Additional wavelengths and sizes available upon request.

Part Number Examples:

- DLP-190x190-625** DLP 190 x 190mm, 625 red wavelength
- DLP-300x300-WHI-1105x05** DLP 300 x 300 mm, white, Patterned Area Light with 5 mm gradient lines and 5 mm gap
- DLP-450x450-WHI-215x15-10** DLP 450 x 450 mm, white, Patterned Area Light with 15 mm grid (dark lines), 15 mm light gap and 10% gradient.



SIZING A LIGHT

When sizing a light for the most consistent/homogeneous illumination, best practice is to follow the W Rule. The W Rule states: The working distance (WD) is equal to the size of the part (X) and the size of the light is twice the size of the part.

THE W RULE:
The working distance is equal to the size of the part.
The size of the light is twice the size of the part.

If the working distances needs to be increases, the light also needs to increase in size to remain homogeneous.

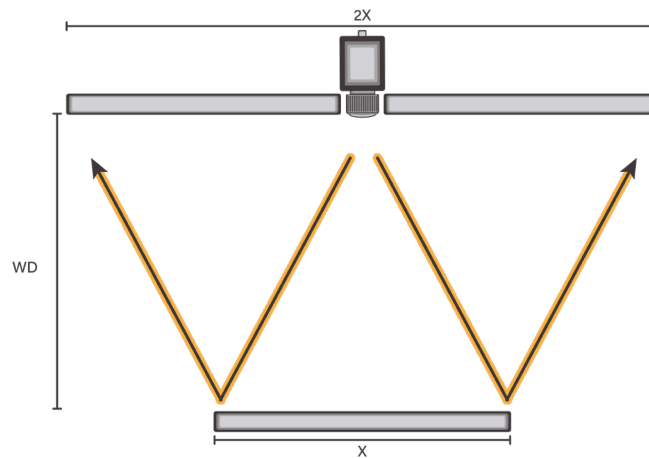

CUSTOM SIZE

Smart Vision Lights can customize a DLP. When requesting a custom DLP, include the following: size (Length x Width) in millimeter, what side the 5-pin M12 connectors should be placed on, and desired wavelength (color).



MOUNTING

The DLP includes four 30 mm industrial extrusions for mounting. Smart Vision Lights recommends using drop-in T-nuts for mounting a DLP.

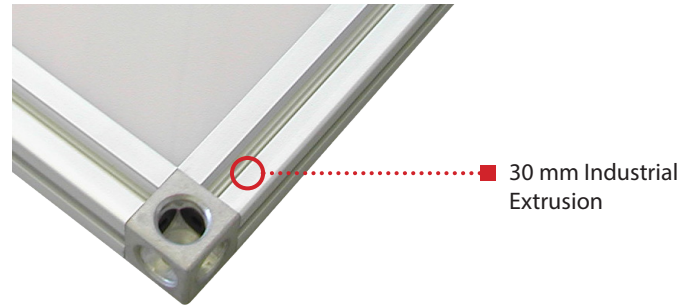

NOTE

Removing corner cubes of light may result in voiding of warranty.



PATTERNED AREA LIGHTING™

Patterned Area Lighting (PAL) is used for isolating defects on uneven, highly specular, and/or clear surfaces, which can be difficult with standard lighting methods. PAL can be used to isolate a defect in a single image acquisition. With PAL, small defects will reflect off the surface at an equal but opposite angle. Distortion of the reflected image can also reveal surface deformations.

How to use PAL

- For backlighting a transparent object, the light is positioned beneath the object.
- For front lighting, position the light where the light pattern will be directed on the surface at an angle.
- A camera is positioned to capture the reflection of the light source.
- The camera lens is adjusted to focus on the surface defect.
- The camera should also image the light source pattern, but the pattern does not need to be in tight focus.
- The depth of field for the lens should be adjusted to include both the light source pattern and the defect in one image.

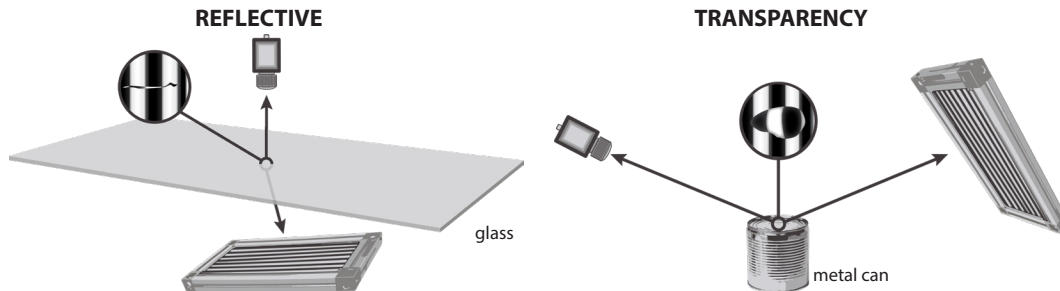

Patterned Area Lighting Examples

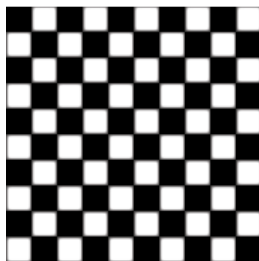

Pattern: Checkerboard
Size: 50 mm x 50 mm square

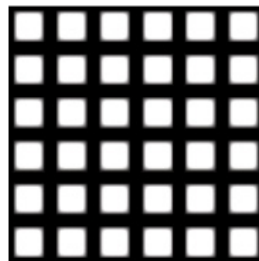

Grid
50 mm line width

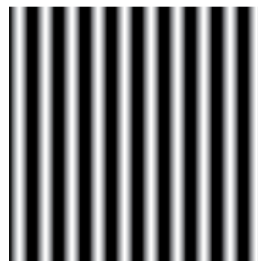

Gradient Lines
50 mm line width

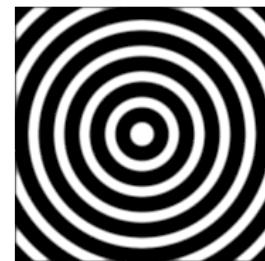

Circles
50 mm circle thickness

Customized pattern sizes available upon request.

NOTE

Smart Vision Lights can customize just about any pattern needed to meet application requirements.



ACCESSORIES

Power Cables



Length	Part Number
5 m	5PM12-5
10 m	5PM12-10
15 m	5PM12-15

Camera Mount



Description	Part Number
DLP-190x190	BKT0005
DLP-300x300	BKT0006
DLP-450x450	BKT0013
DLP-600x600	BKT0014

Variable Control Pot



Description	Part Number
Variable Control Pot	IVP-C1



GLOSSARY

This glossary covers all Smart Vision Lights product families; some content in this section may not apply to this specific light.

TERMINOLOGY

OverDrive™ Lights include an integrated high-pulse driver for complete LED light control.

Continuous Operation Lights stay on continuously.

Multi-Drive™ Combines continuous operation and OverDrive™ strobe (high-pulse operation) mode into one easy-to-use light.

Built-In Driver The built-in driver allows full function without the need of an external controller.

Camera to Light Connecting the light directly to the camera, without the need for additional controllers or equipment.

Polarizers Filters that reduce reflections on specular surfaces.

Diffuser Used to widen the angle of light emission, reduce reflections, and increase uniformity.

TYPES OF ILLUMINATION

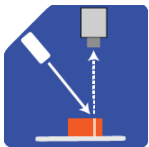

Projector

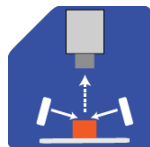

Dark Field

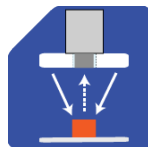

Radial



Bright Field

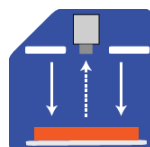

Direct

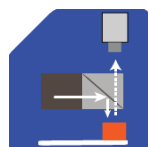

Axial

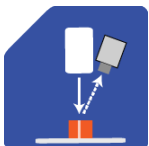

Line

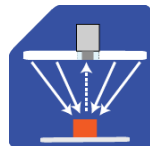

Diffuse Panel

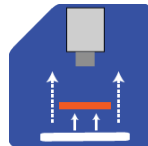

Backlight

COMMON COLOR/WAVELENGTHS LEGEND

Wavelength options range from 365 nm to 1550 nm. Additional wavelengths available for many light families.

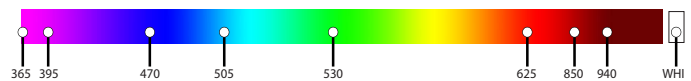

See Part Number section for **this light's** available standard wavelengths.



Shortwave infrared LEDs are available in 1050 nm, 1200 nm, 1300 nm, 1450 nm, and 1550 nm.

Check Part Number section to see if **this light** is available in SWIR wavelengths.