

P R O D U C T D A T A S H E E T

Two Holes for
Camera Mounting
(On Back)

Fourteen T-slots for Mounting

Signal Indicator LED
(Yellow)

5-Pin M12 Connector

Power Indicator LED
(Green)

40 mm Camera
Viewing Hole

High-Intensity LEDs

235 mm Viewing Area



Warranty
10
YEAR

Compliant
IEC
62471

Compliant
CE
RoHS

Rated
IP
50

Connector
5-PIN
M12

PRODUCT HIGHLIGHTS

- ✓ Built-in Multi-Drive™ allows the light to work in continuous operation or OverDrive™ mode
- ✓ SafeStrobe™ technology ensures protected operation of LEDs
- ✓ Built-in driver; no external wiring needed
- ✓ PNP and NPN strobe input
- ✓ 5-pin M12 quick connect





PRODUCT INTRODUCTION

The DDL-250 is a dome light with a 235 mm viewing area designed for reading barcode, imperfections/rounded/highly reflective products or for inspecting products with an even, uniform, and repeatable light intensity. The DDL-250 has been designed with simplicity and functionality in mind. The DDL-250 features Multi-Drive™, which allows the user to operate the light in continuous operation or OverDrive™ strobe mode, depending on wiring method. NPN and PNP trigger signal input and a built-in 1–10VDC analog intensity control allows for maximum versatility. The industry standard 5-pin M12 connector makes for easy installation.



PRODUCT SPECIFICATIONS

	CONTINUOUS OPERATION	OVERDRIVE™ STROBE MODE
Electrical Input	24VDC +/-5%	
Input Current	Max. 1.45 A	Max. 5.8 A
Wattage	Max. 34.8 W	Max. 140 W
PNP Line	4 mA @ 4VDC 10 mA @ 12VDC 20 mA @ 24VDC	
NPN Line	15 mA @ ground (0VDC)	
OverDrive™ Strobe Mode	Not applicable	Connect pin 5 to GND (see Wiring Configuration for more information)
Strobe Duration	Not applicable	Min. 10 μ s Max. 50 ms (see SafeStrobe™ Technology for more information)
Duty Cycle	Not applicable	Max. 10%
Strobe Input	Not applicable	PNP: +4VDC or greater to activate NPN: GND (<1VDC) to activate
Continuous Operation Mode	NPN can be tied to ground OR PNP can be tied to 24VDC (not both)	Not applicable
On/Off Input	PNP: +4VDC or greater to activate NPN: GND (<1VDC) to activate	Not applicable
Connection	5-pin M12 connector	
Ambient Temperature	-18°–50°C (0°–122°F)	
IP Rating	IP50	
Weight	2.27 kg	
Compliances	CE, RoHS, IEC 62471	
Warranty	10 years. For complete warranty information, visit smartvisionlights.com/warranty .	



RESOURCE CORNER

Additional resources, including CAD files, videos, and application examples are available on our website.



WIRING CONFIGURATION

CONTINUOUS OPERATION MODE

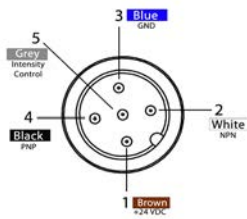

Pin layout for light (male connector)

Pin	Function	Signal	Wire Color
1	Power In	+24VDC	BROWN
2	NPN	Sinking Signal	WHITE
3	GND	Ground	BLUE
4	PNP	Sourcing Signal	BLACK
5	Intensity Control	1–10VDC	GREY

Some cables use green/yellow for pin 5.

For maximum intensity, it is possible to tie pin 5 to pin 1 at +24VDC.

For continuous mode: PNP (pin 4) can be tied to +24VDC (pin 1) or NPN (pin 2) can be tied to Ground (pin 3).

For proper function, apply either PNP or NPN signal, **not both**.

Failure to supply light with correct input current will result in **non-repeatable lighting**.
(see Product Specifications for requirements)

OVERDRIVE™ OPERATION MODE

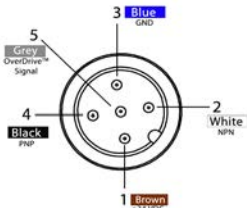

Pin layout for light (male connector)

Pin	Function	Signal	Wire Color
1	Power In	+24VDC	BROWN
2	NPN	Sinking Signal	WHITE
3	GND	Ground	BLUE
4	PNP	Sourcing Signal	BLACK
5	OverDrive™ Signal	Ground	GREY

Some cables use green/yellow for pin 5.

Failure to supply light with correct input current will result in **non-repeatable lighting**.

(see Product Specifications for requirements)



LIGHT PATTERNS

Smart Vision Lights recommends that the DDL-250 be used at a working distance between 25 mm and 100 mm.

LIGHTING ILLUMINATION FOR THE DDL-250

Continuous Operation Mode	
Typical Output Performance	Illumination (Lux)
Distance = 25 mm	41,000
<i>Illuminance measurement taken on White Light — 4800K</i>	

OverDrive™ Mode	
Typical Output Performance	Illumination (Lux)
Distance = 25 mm	205,000
<i>Illuminance measurement taken on White Light — 4800K</i>	

The DDL-250 Dome Light produces a uniform light pattern.

WD = Working Distance (Grid set to 50 mm x 50 mm)

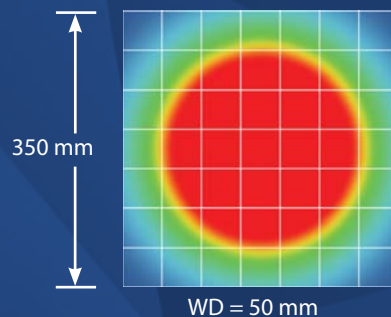

PRODUCT DRAWING

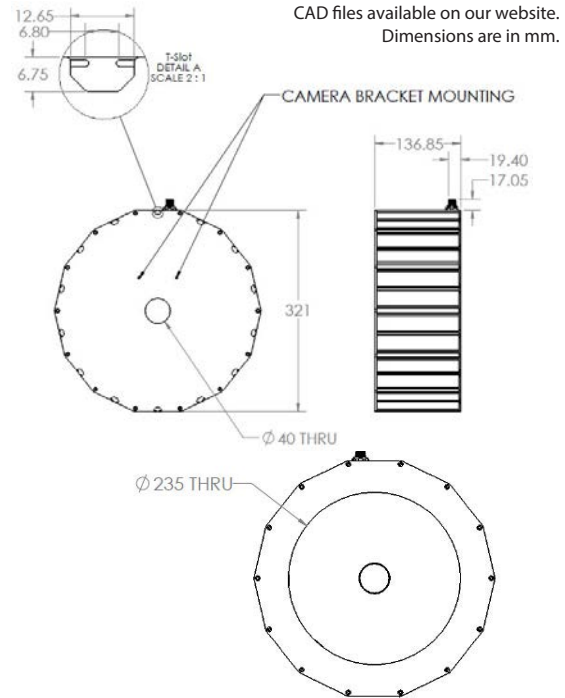

ILLUMINATION

DDL-250 Dome Lights work best for:

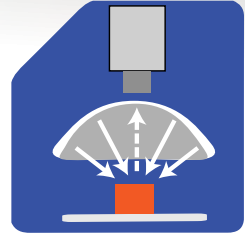

Dome "Light Tent"

LIGHT OUTPUT CUTAWAY

The dome shape gives the product a particular advantage in uniformity when illuminating and reading OCR codes on reflective or round surfaces.

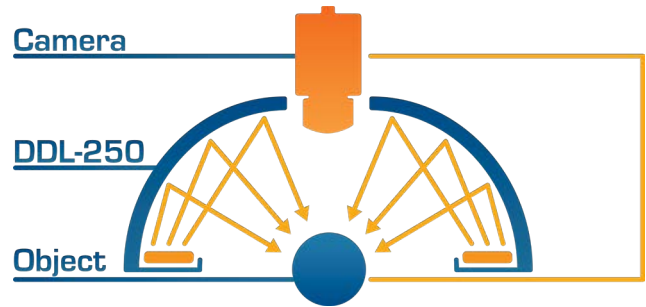

EYE SAFETY

According to IEC 6247:2006. Full documentation available upon request



Notice

Exempt Group: No photobiological hazard to eyes or skin even for continuous, unrestricted use. Applicable for wavelength 625.

Caution

Risk Group 1: Possibly hazardous optical radiation emitted from this product. Do not stare at operating lamp. May be harmful to eyes. Safe for most applications except for prolonged exposure. Applicable for wavelengths 470, 530, and WHI.



PART NUMBER

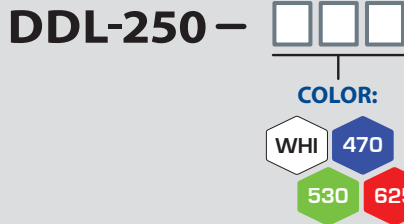

Part Number Example:
DDL-250-625 (DDL-250, 625 Red Wavelength)

Additional wavelength available upon request.



MOUNTING

Fourteen standard industrial T-slots for mounting the DDL-250 are included. The DDL-250 has two M4 threaded holes on the back for mounting a camera. See Accessories for camera mounting options.

Hardware included with light:

- (2) M4x8 mm screws (hex)
- (2) T-nuts



MULTI-DRIVE™

Multi-Drive™ offers the best of both worlds. Continuous operation and OverDrive™ mode (high-output strobe/pulse) are available in a single driver. Other advantages of Multi-Drive™ include faster imaging and capture/freeze motion on high-speed lines.



With Multi-Drive™ users can run the driver continuously or in OverDrive™ at any allowed intensity by simply setting the product configuration. OverDrive™ operation has **up to ten times** the power of continuous operation.



SAFESTROBE™ TECHNOLOGY

SafeStrobe™ technology applies safe working parameters to ensure that high-current LEDs are not damaged by being driven beyond their limits, such as maximum strobe time or duty cycle. SafeStrobe™ is built into the DDL-250.



DUTY CYCLE (OVERDRIVE™ MODE ONLY)

This section applies only to OverDrive™ Mode.

The duty cycle (D) is related to the strobe time (ST) and the rest time (RT).

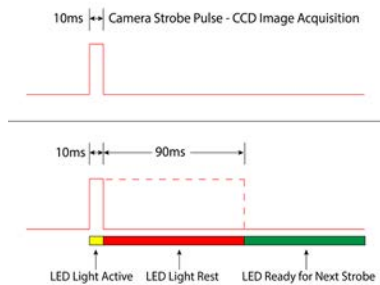

Light follows strobe pulse - the light output will track the width of the strobe pulse.

Calculating Rest Time

$$RT = \frac{ST}{D} - ST$$

RT = Rest Time
ST = Strobe Time
D = Duty Cycle

Example

$$RT = \frac{10 \text{ ms}}{.1} - 10 \text{ ms} = 90 \text{ ms}$$

Rest Time is 90 ms for 10 ms Strobe Time

Maximum duty cycle for OverDrive™ light is 10% (0.1).



ACCESSORIES

Camera Mount	
	
Description	Part Number
Right Angle Mount	BKT0004

Camera Mount	
	
Description	Part Number
Adjustable Point Mount	BKT0007

Power Cables	
	
Length	Part Number
5 m	5PM12-5
10 m	5PM12-10
15 m	5PM12-15

Jumper Cables	
	
Lengths	Part Number
300 mm	5PM12-J300
1000 mm	5PM12-J1000
2000 mm	5PM12-J2000



GLOSSARY

This glossary covers all Smart Vision Lights product families; some content in this section may not apply to this specific light.

TERMINOLOGY

OverDrive™ Light include an integrated high-pulse driver for complete LED light control.

Continuous Operation Light stays on continuously.

Multi-Drive™ Combines continuous operation and OverDrive™ strobe (high-pulse operation) mode into one easy-to-use light.

Built-In Driver Allows full function without the need for an external controller.

Camera to Light Connect the light directly to the camera, without the need for additional controllers or equipment.

Polarizers Filters that reduce reflections on specular surfaces.

Diffusers Used to widen the angle of light emission, reduce reflections, and increase uniformity.

TYPES OF ILLUMINATION

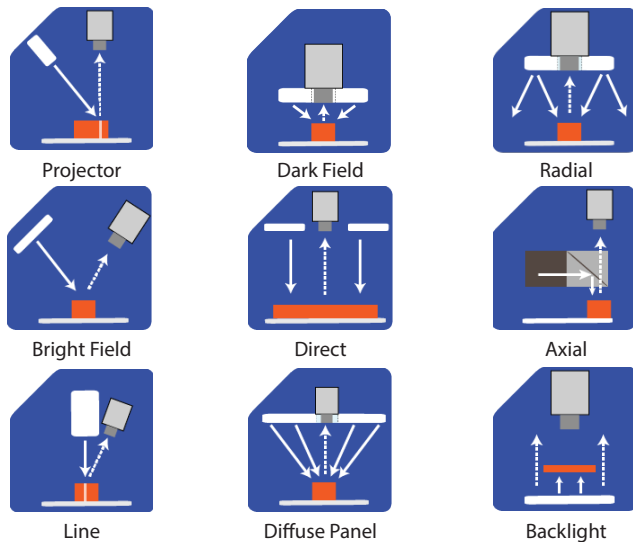

COLOR/WAVELENGTHS LEGEND

Wavelength options range from 365 nm to 1550 nm. Additional wavelengths available for many light families.

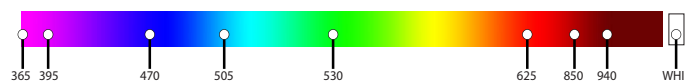

*See Part Number section for available standard wavelengths for **this light**.



Shortwave infrared LEDs are available in 1050 nm, 1200 nm, 1300 nm, 1450 nm, and 1550 nm.