

## MANHATTAN KITCHEN MIXER

1.9108.80.0.XX



### PRODUCT DIMENSIONS:

Front view:

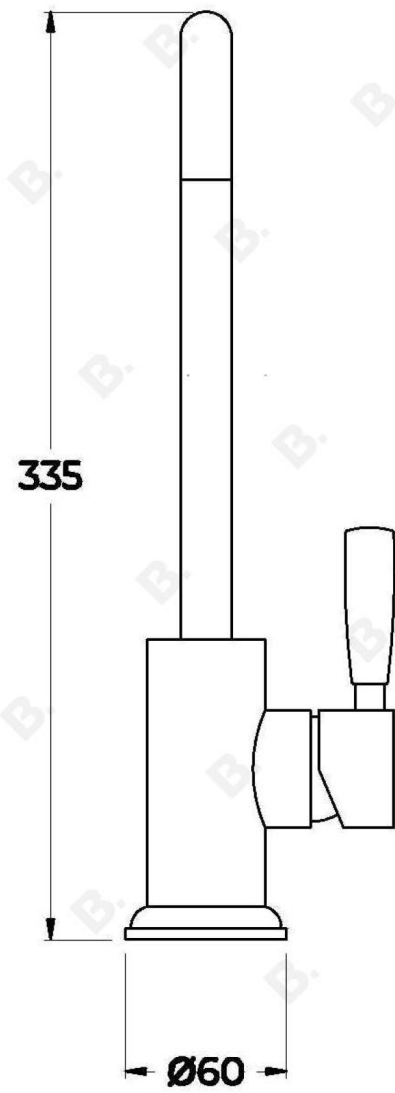

Side view:

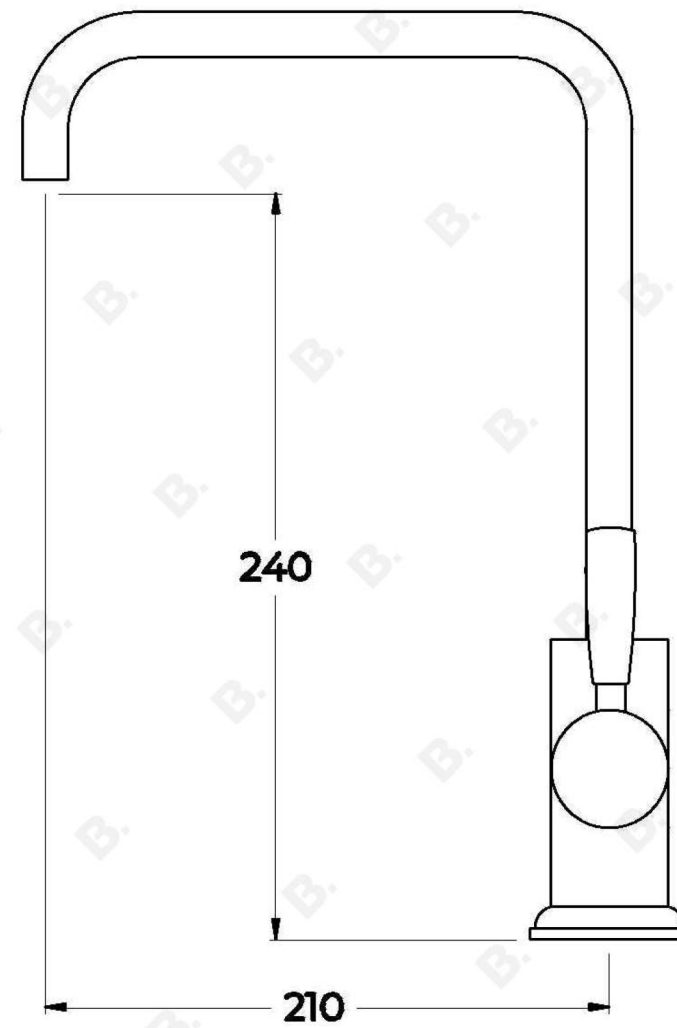

Top view:

