









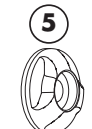

ATTACCHI SPECIFICI PER - SPECIFIC FITTING KIT FOR
 KIT DE MONTAGE SPECIFIQUE POUR - SPEZIFISCHER MONTAGEKIT FÜR
 ANCLAJE ESPECÍFICO PARA

HONDA SH 125-150 2009

ISTRUZIONI DI MONTAGGIO - MOUNTING INSTRUCTIONS
 INSTRUCTIONS DE MONTAGE - BAUANLEITUNG - INSTRUCCIONES DE MONTAJE

<p>①</p>  <p>SUPPORTO SUPPORT SUPPORT HALTERUNG SOPORTE</p> <p>Q.TY n.2(Dx-Sx)</p>	<p>②</p>  <p>VITE TEF M8x20mm SCREW VIS SCHRAUBE TORNILLO</p> <p>Q.TY n.4</p>	<p>③</p>  <p>DADO A.B. M8 FLANGIATO BOLT M8 ECROU M8 MUTTER M8 TUERCA M8</p> <p>Q.TY n.4</p>	<p>④</p>  <p>VITE TBEI M6x30mm SCREW VIS SCHRAUBE TORNILLO</p> <p>Q.TY n.4</p>	<p>⑤</p>  <p>BOCCOLA DI RITENZIONE z1861 PLASTIC BUSH DOUILLE PLASTIQUE PLASTIK BUCHSE CASQUILLO</p> <p>Q.TY n.4</p>	
<p>⑥</p>  <p>GOMMINO z1856 FAIRLEADER CHAUMARD GUMMI GOMA</p> <p>Q.TY n.4</p>	<p>⑦</p>  <p>DISTANZIALE Ø10x6mm Foro Ø6mm, V1862 SPACER ENTRETOISE DISTANZSTUECK DISTANCIADOR</p> <p>Q.TY n.4</p>	<p>⑧</p>  <p>GOMMINO z1857 FAIRLEADER CHAUMARD GUMMI GOMA</p> <p>Q.TY n.4</p>	<p>⑨</p>  <p>DADO A.B. M6 FLANGIATO BOLT M6 ECROU M6 MUTTER M6 TUERCA M6</p> <p>Q.TY n.4</p>	<p>⑩</p>  <p>NON INCLUSO NOT INCLUDED PAS INCLUS NICHT INKLUDIERT NO ESTÁ INCLUIDO</p>	<p>⑪</p> <p>COMPONENTI ORIGINALI ORIGINAL PARTS PARTIES ORIGINALES ORIGINAL BAUTEILE COMPONENTES ORIGINALES</p> <p>Q.TY n.-</p>

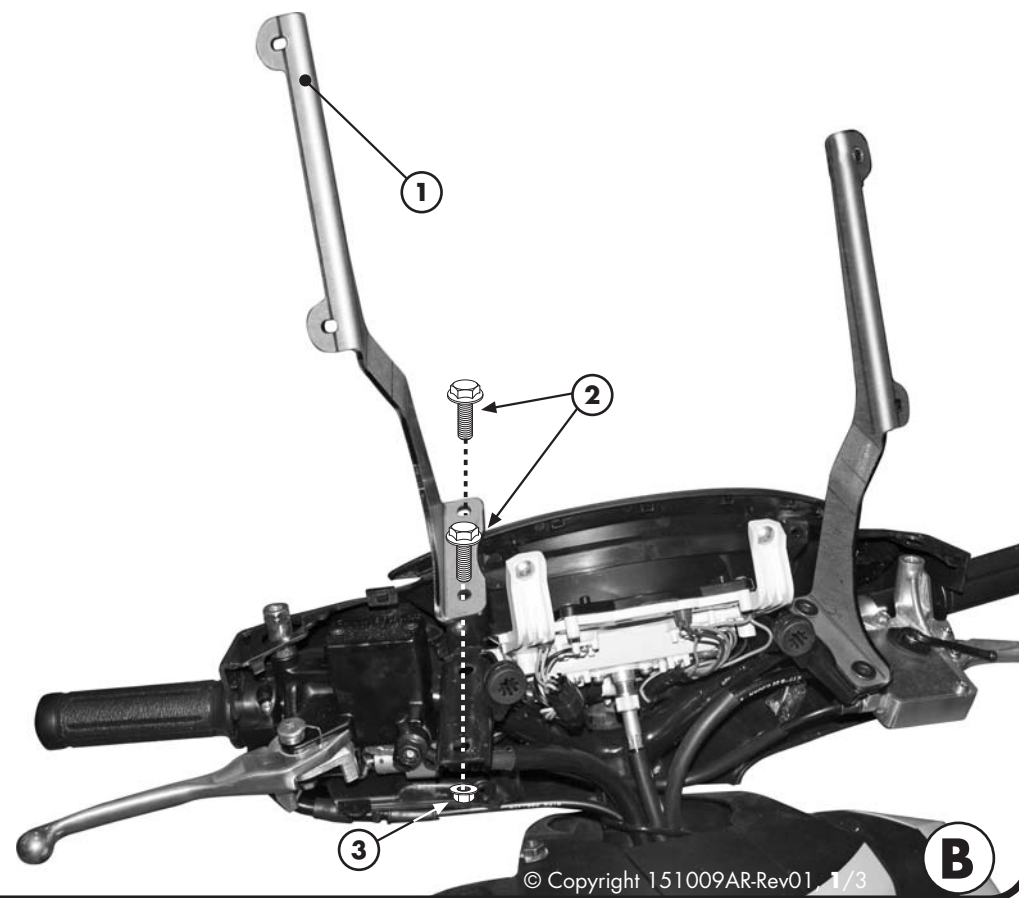

ATTACCHI SPECIFICI PER - SPECIFIC FITTING KIT FOR
KIT DE MONTAGE SPECIFIQUE POUR - SPEZIFISCHER MONTAGEKIT FÜR
ANCLAJE ESPECÍFICO PARA

HONDA SH 125-150 2009

ISTRUZIONI DI MONTAGGIO - MOUNTING INSTRUCTIONS
INSTRUCTIONS DE MONTAGE - BAUANLEITUNG - INSTRUCCIONES DE MONTAJE

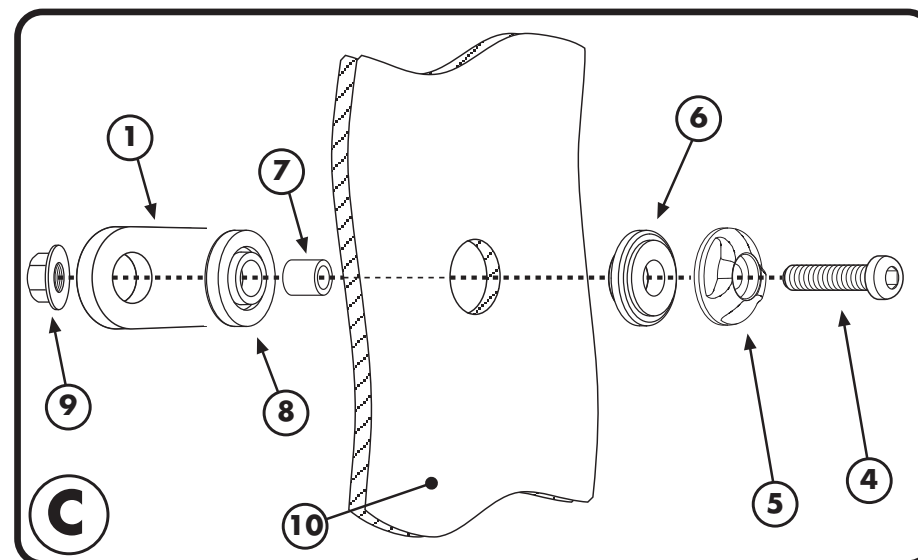
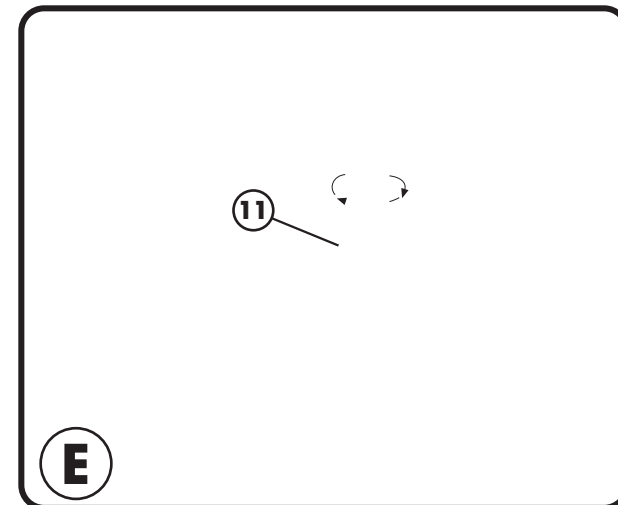
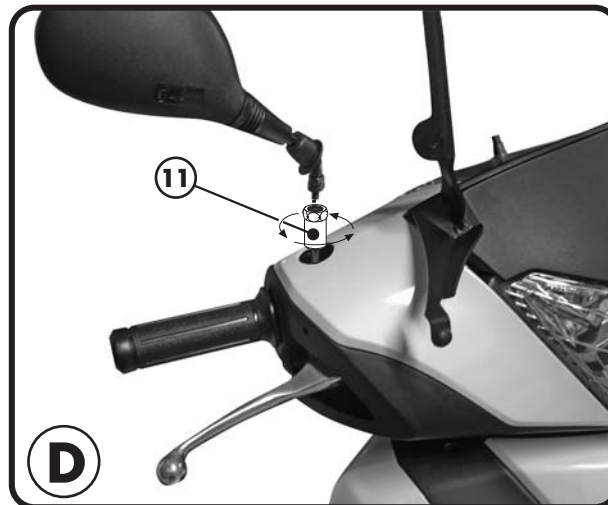

ATTACCHI SPECIFICI PER - SPECIFIC FITTING KIT FOR
KIT DE MONTAGE SPECIFIQUE POUR - SPEZIFISCHER MONTAGEKIT FÜR
ANCLAJE ESPECÍFICO PARA

HONDA SH 125-150 2009

ISTRUZIONI DI MONTAGGIO - MOUNTING INSTRUCTIONS
INSTRUCTIONS DE MONTAGE - BAUANLEITUNG - INSTRUCCIONES DE MONTAJE

I ISTRUZIONI DI MONTAGGIO

1. SMONTARE IL GRUPPO OTTICO ANTERIORE DELLO SCOOTER COME MOSTRATO IN FIGURA A;
2. FISSARE I SUPPORTI COME INDICATO IN FIGURA B;
3. RIMONTARE I COMPONENTI ORIGINALI DELLO SCOOTER;
4. MONTARE IL PARABREZZA (NON INCLUSO NELLA CONFEZIONE) COME INDICATO IN FIGURA C;
5. PUNTARE IL DADO SPECIALE ORIGINALE (PARTICOLARE N°11) AL FILETTO. TENENDO FERMO LO SPECCHIETTO APPOGGIARLO SUL DADO ED AVVITARE QUEST'ULTIMO: IN QUESTO MODO SI AVVITERANNO CONTEMPORANEAMENTE SIA IL DADO CHE LO SPECCHIETTO;
6. SERRARE IL CONTRODADO ORIGINALE DELLO SPECCHIETTO;
7. ULTIMARE IL MONTAGGIO VERIFICANDO CHE TUTTE LE VITI SIANO SERRATE BENE (VITI M6=9,6Nm - VITI M8=23Nm)

GB MOUNTING INSTRUCTIONS

1. DISASSEMBLE THE FRONT HEADLIGHT FAIRING OF THE SCOOTER AS SHOWN IN PICTURE A;
2. ATTACH THE SUPPORTS AS SHOWN IN PICTURE B;
3. RE-INSTALL THE SCOOTER'S ORIGINAL COMPONENTS;
4. INSTALL THE WIND-SCREEN (NOT INCLUDED IN THE BOX) AS SHOWN IN PICTURE C;
5. MAKE SURE THAT ALL THE BOLTS ARE TIGHTENED APPROPRIATELY (M6 BOLTS=9.6Nm - M8 BOLTS=23Nm).

F INSTRUCTIONS DE MONTAGE

1. DEMONTER LE GROUPE OPTIQUE AVANT DU SCOOTER COMME ILLUSTRE EN PHOTO A;
2. FIXER LES SUPPORTS COMME INDIQUE EN PHOTO B;
3. REMONTER LES COMPOSANTS D'ORIGINE DU SCOOTER;
4. MONTER LE PARE-BRISE (NON INCLUS DANS LA BOITE)
5. METTRE EN PLACE L'ECROU SPECIAL D'ORIGINE (PIECE N°11) SUR LE FILETAGE, EN RETENANT LE RETROVISEUR, LE POSER SUR L'ECROU ET LE VISSER: DE CETTE FACON L'ECROU VA SE VISSER EN MEME TEMPS QUE LE RETROVISEUR;
6. SERRER LE CONTRE-ECROU D'ORIGINE DU RETROVISEUR. COMME INDIQUE EN PHOTO C;
7. TERMINER LE MONTAGE EN CONTROLANT LE BON SERRAGE DE TOUTES LES VIS (VIS M6=9,6Nm - VIS M8=23Nm).

D BAUANLEITUNG

1. ENTFERNEN SIE DEN SCHEINWERFER DES FAHRZEUGES WIE IM BILD A GEZEIGT;
2. BEFESTIGEN SIE DIE HALTERUNGEN WIE IM BILD B HINGEWIESEN;
3. MONTIEREN SIE DIE ORIGINALTEILE WIEDER AN;
4. MONTIEREN SIE DIE SCHEIBE (NICHT ENTHALTEN) WIE IM BILD C GEZEIGT;
5. BEFESTIGEN SIE DIE SPEZIFISCHE ORIGINALMUTTER (POSITION N°11) AN DEM GEWINDE. HALTEN SIE DEN SPIEGEL FEST, STELLEN SIE DEN SPIEGEL GEGENWÄRTIG DER MUTTER UND BEFESTIGEN SIE DIESE: AUF DIESE WEISE WERDEN DIE MUTTER UND DER SPIEGEL GLEICHZEITIG ANGESCHRAUBT;
6. ZIEHEN SIE DIE ORIGINALMUTTER AN DEM SPIEGEL FEST.
7. ZULETZT ÜBERPRÜFEN SIE DASS ALLE SCHRAUBEN (VITI M6=9,6NM - VITI M8=23NM) FESTGEZOGEN WURDEN.

ES INSTRUCCIONES DE MONTAJE

1. DESMONTAR EL GRUPO ÓPTICO DELANTERO DEL SCOOTER COMO SE MUESTRA EN LA FOTO A;
2. PROCEDER A LA FIJACIÓN DE LOS SOPORTES COMO SE MUESTRA EN LA FOTO B;
3. VOLVER A MONTAR LAS PIEZAS ORIGINALES DEL SCOOTER;
4. MONTAR EL PARABRISAS (QUE NO ESTÁ INCLUIDO EN ESTA REFERENCIA) COMO SE MUESTRA EN LA FOTO C;
5. COLOCAR LA TUERCA ORIGINAL QUE TIENE CARACTERÍSTICAS ESPECIALES (REFERENCIA N.11) AL TORNILLO. POSICIONAR EL RETROVISOR Y APOYÁNDOLO ENCIMA DE LA TUERCA APRETARLA: DE ESTA MANERA SE ATORNILLARÁN AL MISMO TIEMPO LA TUERCA Y EL RETROVISOR;
6. APRETAR MUY BIEN LA CONTRA-TUERCA ORIGINAL DEL RETROVISOR;
7. TERMINAR EL MONTAJE VERIFICANDO QUE TODOS LOS TORNILLOS ESTEN BIEN APRETADOS (TORNILLOS M6=9,6NM - TORNILLOS M8=23NM)