

# Fiilex

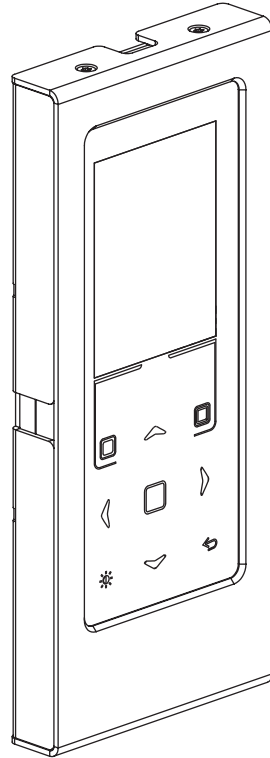

## Wall Controller

FLXA095

User Manual

## General Notes:

- Please read the following operating instructions very carefully before using this fixture for the first time. They contain important information on the operation of Fiilex lighting equipment.
- For your own safety, please follow all safety instructions and warnings.
- Keep these operating instructions for you and subsequent users for reference in the future.
- For further information, please ask your retailer or inquire at your local authorities. Only use Fiilex spare parts and accessories ([www.fillex.com](http://www.fillex.com)).

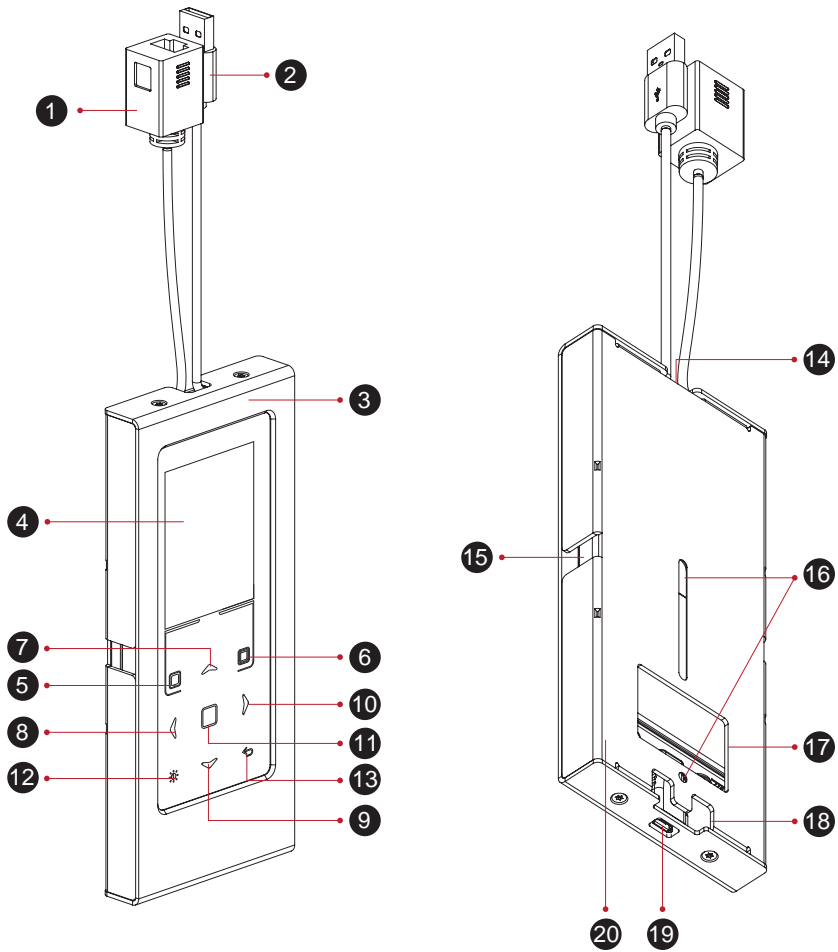

## Parts Diagram

1. RJ45 Port (DMX In/Out)
2. USB Port
3. Front Cover
4. Controller Display
5. Scene 1 Quick Button
6. Scene 2 Quick Button
7. Up Button
8. Left Button
9. Down Button
10. Right Button
11. Confirm Button
12. Light On/Off Button
13. Return Button
14. Top Cable Outlet Slot
15. Side Cable Outlet Slot
16. Self Tapping Screw Slot
17. Back Cable Outlet Slot
18. Bottom Cable Outlet Slot
19. Micro USB Port
20. Back Plate

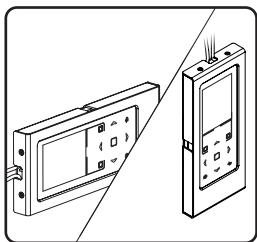

### Orientation

The Wall Controller can be positioned in landscape or portrait mode.

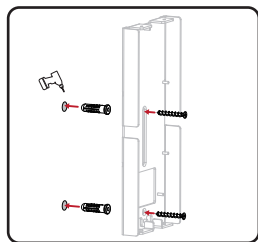

### Mount the Back Plate

If mounting to dry wall, pre-drill two 1/4" holes and insert nylon anchors before screwing in the plate.

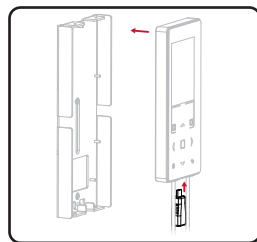

### Insert Micro USB Adapter

Insert Micro USB Adapter (19) before attaching the Wall Controller to the Back Plate (20).

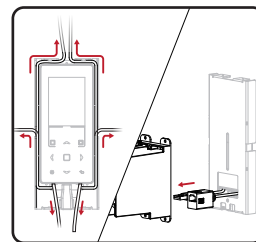

### Configure the Cable

The cables can be arranged in multiple directions.

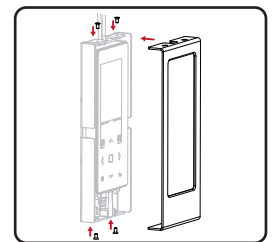

### Secure the Cover

Screw the Front Cover (3) back in.

## Compatibility

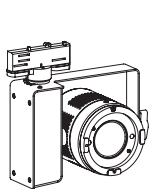

T360

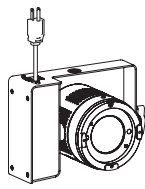

C360



P360 Series  
(except P360 Classic)

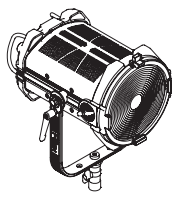

Q8 Series

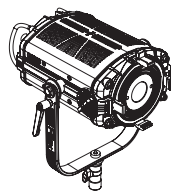

Q1000

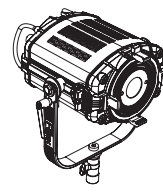

Q500

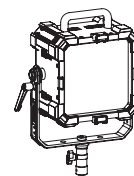

Matrix II Series  
(requires converter)

## Basic Operation



Press Scene 1 or 2 (Quick Button 5 or 6) to alternate between the two preset.

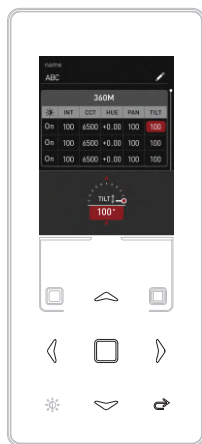

In any screen, press the direction buttons (7-10) to navigate to the desired position. Press the Confirm Button (11) to enter. Press the Return Button (13) to return to the previous screen.

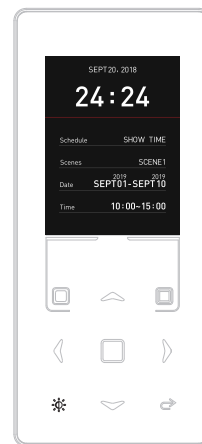

Press the Light On/Off Button (12) to directly turn the fixtures on or off.

## Specifications

Dimension	With Mount : 7in x 3in x 0.7in / 17.8 cmx 7.6cm x 1.8cm Without Mount : 5.6in x 2.5in x 0.6in / 14.2cm x 6.4cm x 1.4cm
Cable Length	15.2in / 38.6cm
Weight	With Mount : 0.82lb / 370g Without Mount : 0.3lb / 150g
Rating	5V=0.3A
USB Adapter	Micro USB Male to Female
Certifications	FCC, CE, UL

## Safety

**\* Be sure the DC to AC 120V adapter is properly insulated.**

- Do not attempt to disassemble the body of controller.
- Do not install the controller in a damp or wet area.
- Use only the included power supply.
- Use only a soft, dry towel to gently clean the controller.
- Do not use if air temperature is over 40 °C (104 °F) or under 0 °C (32 °F).

## Warranty

Unless otherwise stated, your product is covered by a **one year parts and labor limited warranty**. Fiilex guarantees, to the original buyer, that this product is to be free of defects in both workmanship and material for a period of one year from the date of shipment. This warranty extends to all products which have proved defective through normal use but excludes products that have been disassembled, modified or misused by the buyer or any other person. This warranty is in lieu of all other warranties, and disclaims all warranties expressed or implied, including any warranty of merchantability, fitness for a particular purpose, or arising from the course of dealing between the parties or usage of trade.

### Returning an Item Under Warranty for Repair

It is necessary to obtain a Return Authorization Number (RA#) from your dealer/ point of purchase BEFORE any units are returned for repair. Fiilex will make the final determination as to whether or not the unit is covered by warranty. Fiilex will replace or repair to proper working condition any products that are returned under warranty. Products repaired or replaced under warranty are under warranty only for the remaining unexpired period of time of the original warranty.

Any Product unit or part returned to Fiilex must be packaged in a suitable manner to ensure the protection of such Product unit or parts. The package must be clearly and prominently marked to indicate that the package contains returned product units or parts with a Return Authorization (RA#) number. All returned product units or parts must be accompanied by a written explanation of the alleged problem or malfunction.