

LEDZEP™ PUNCH

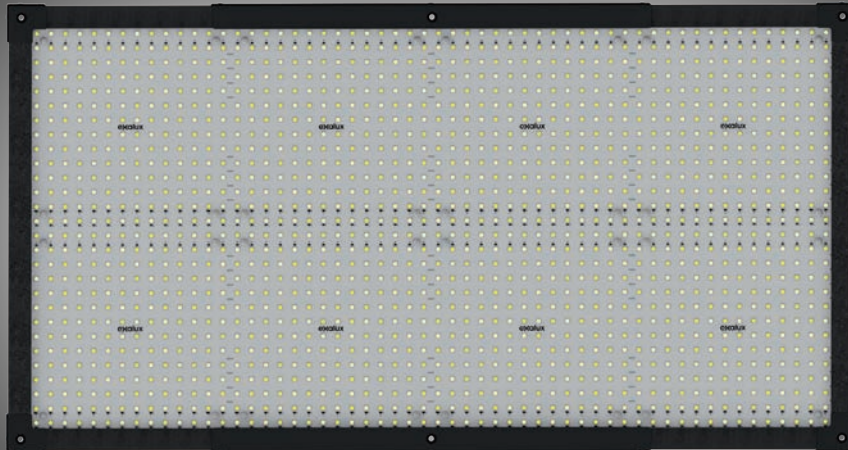

 FRAMELIGHT

sales@framelight.com.au | framelight.com.au

NEW CONCEPT | NEW STANDARD

LEDZEP™ PUNCH is the **ultra-bright** LED panel that sets a new standard for the film industry.

LEDZEP™ PUNCH is thin, lightweight, robust, versatile and fully tunable from 2700K to 6500K.

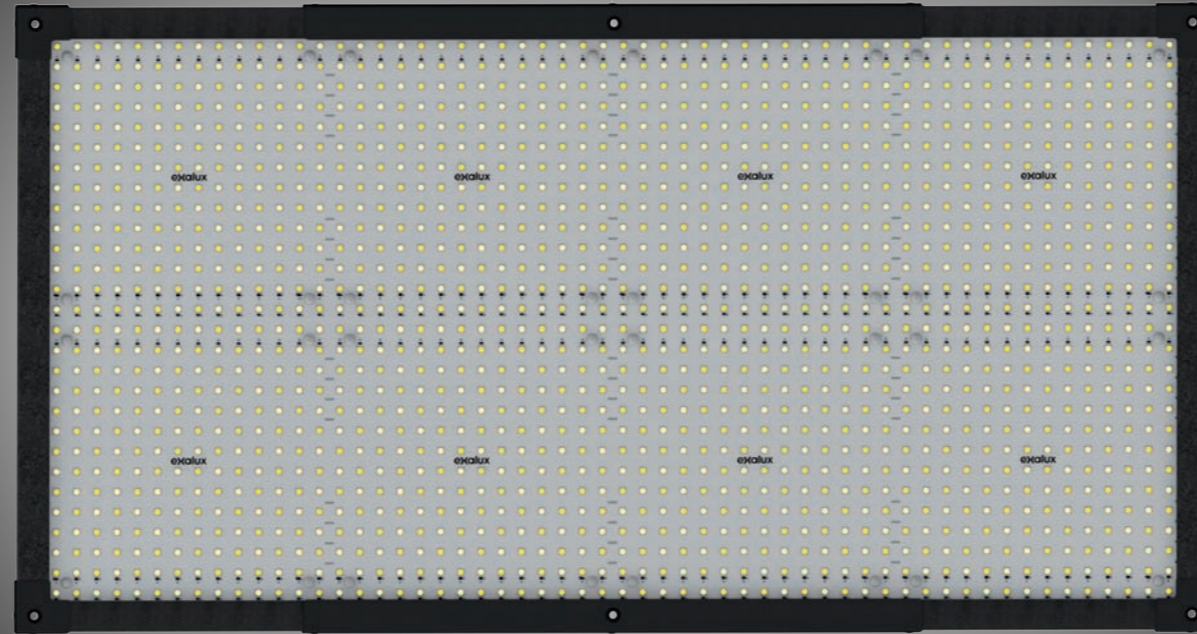

WWW.EXALUX.EU

**LEDZEP
PUNCH
1X4TW2765**

24V . 175W

USE WITH EXALUX OR
USE WITH EXALUX EXTENSION CABLE



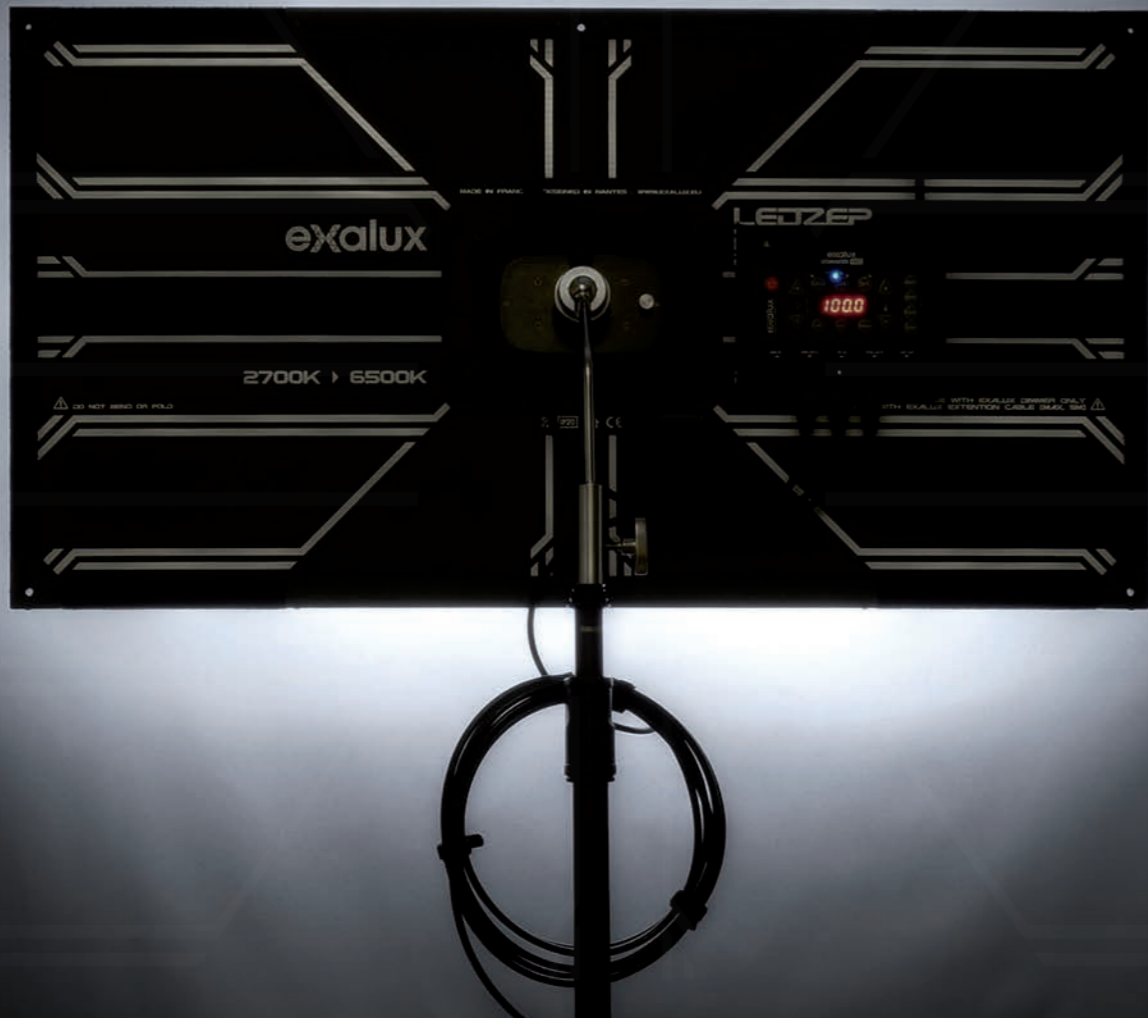

FOCUSED BEAM | MORE ILLUMINANCE

With LEDZEP™ PUNCH, you can get up to 3 times more illuminance thanks to our amazing Punch LED Engine.

Thanks to the focused beam, a maximum of the luminous flux issued from the emitters is used to light up the subject, whereas on standard 120° LED based panels, a part of the luminous flux is lost due to the wide angle. With PUNCH concept, you get more illuminance even when the light is diffused through a diffusion cloth.

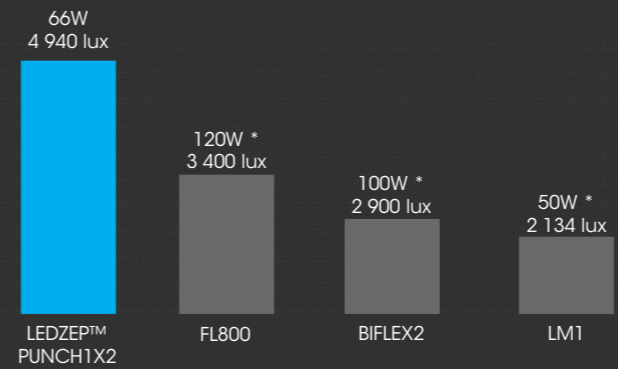

ILLUMINANCE @6500K / @1m
 (*)manufacturer's data

120° SMD LED PANEL

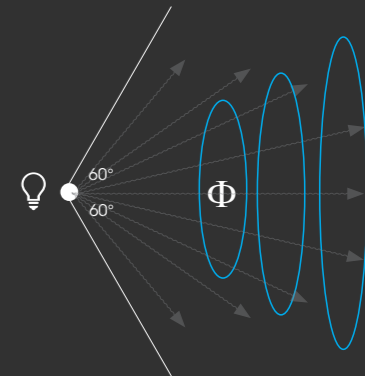

LEDZEP PUNCH WITH FOCUSED BEAM

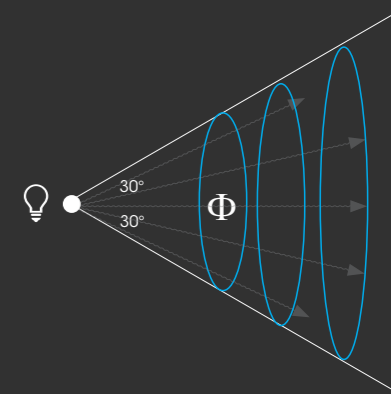

NEW EMITTERS | PERFECT COLOUR RENDITION

Here at EXALUX, we cultivate «The French art of light». We work with light as a noble material with care and passion.

6500K

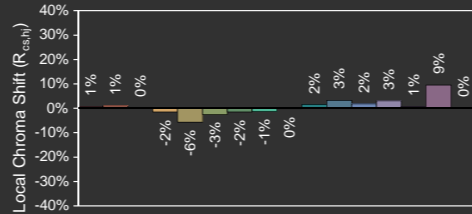
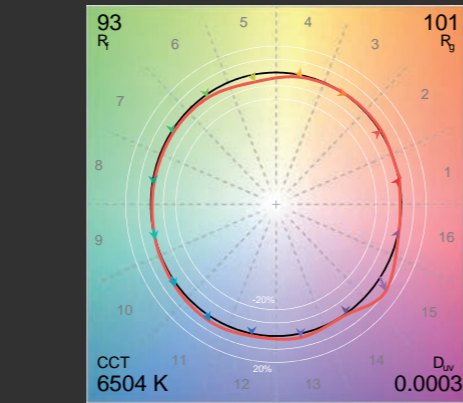
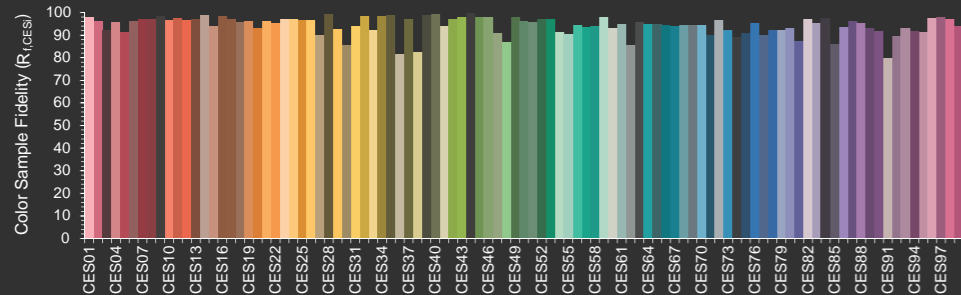

ONLY WHITE | BUT THE RICHEST WHITE

We have selected the finest LED bin to create our powerful Tunable White LED Engine. It delivers a rich and variable white from 2700K to 6500k with a very low chromatic shift.

2700K

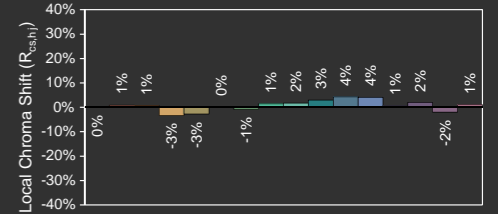
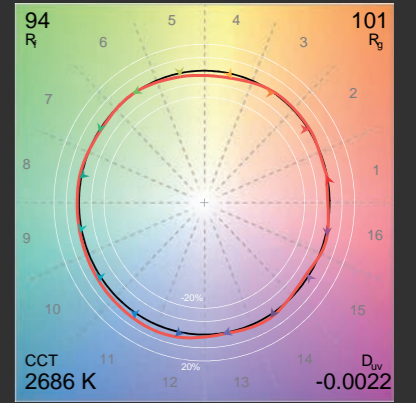
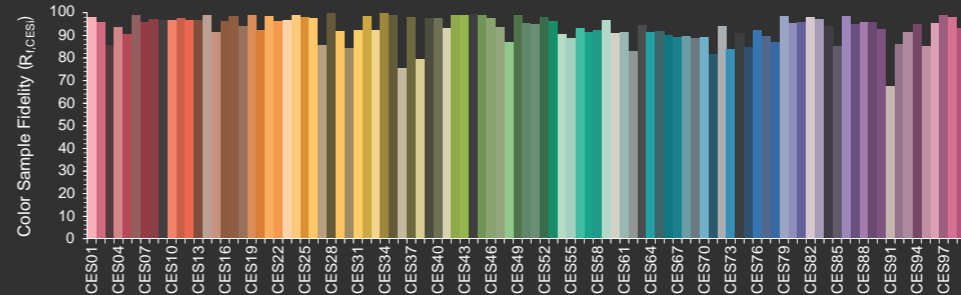
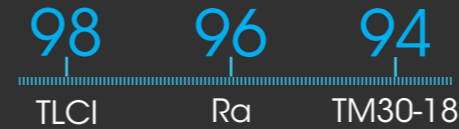

KEY FEATURES | BENEFITS

LOW VOLTAGE INPUT
24VDC,
NEUTRIK XLR4.

EASY TO ACCESSORIZE

Hook & loop fastener allow accessories to be easily and quickly mounted.

RIGGING & LINKING SYSTEM

Threaded holes can be used for rigging or rigging panels together.

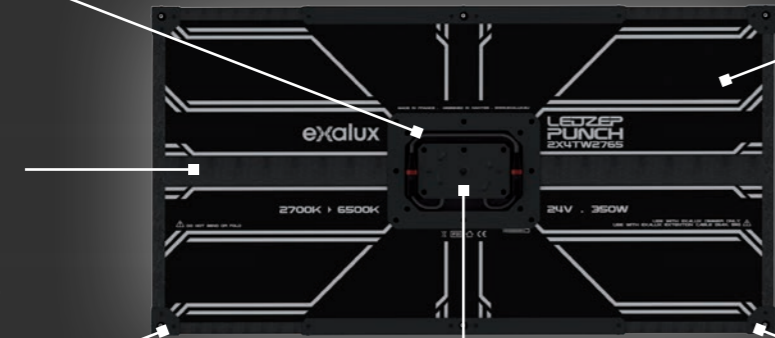

LIGHTWEIGHT AND ROBUST

Rugged body made of strong material.

SHOCK PROOF

We have added protection to the edges to prevent damages when falling.

INDUSTRY STANDARD COMPLIANT

Fully compatible with most removable mounting plates.

PERFECT DIMMING

4KHz ▶ 32KHz PWM compliant.

HIGH COLOUR RENDERING

TLCI : 99,
Ra : 97,
TLC30-18 : 94.

HIGH EFFICIENCY

We integrated constant current driving circuits to ensure CCT and flux constancy and get more flux with less power.

HIGH ILLUMINANCE

High power LED,
60° emission angle.

HIGH PERFORMANCE LED ENGINE

Tunable White : 2700 ▶ 6500K,
Low duv :
-2.60⁻⁰³ ± 5% @2700K
2.89⁻⁰⁵ ± 5% @6500K

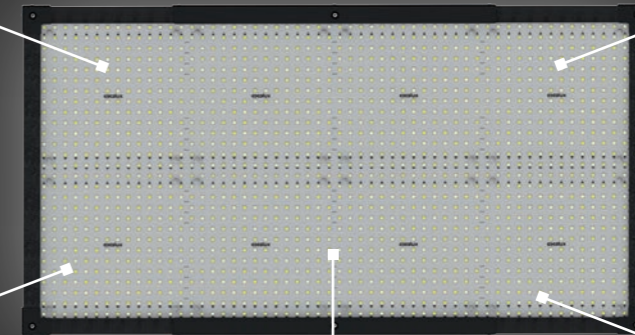

A LEDZEP™ PUNCH | FOR ANY USE

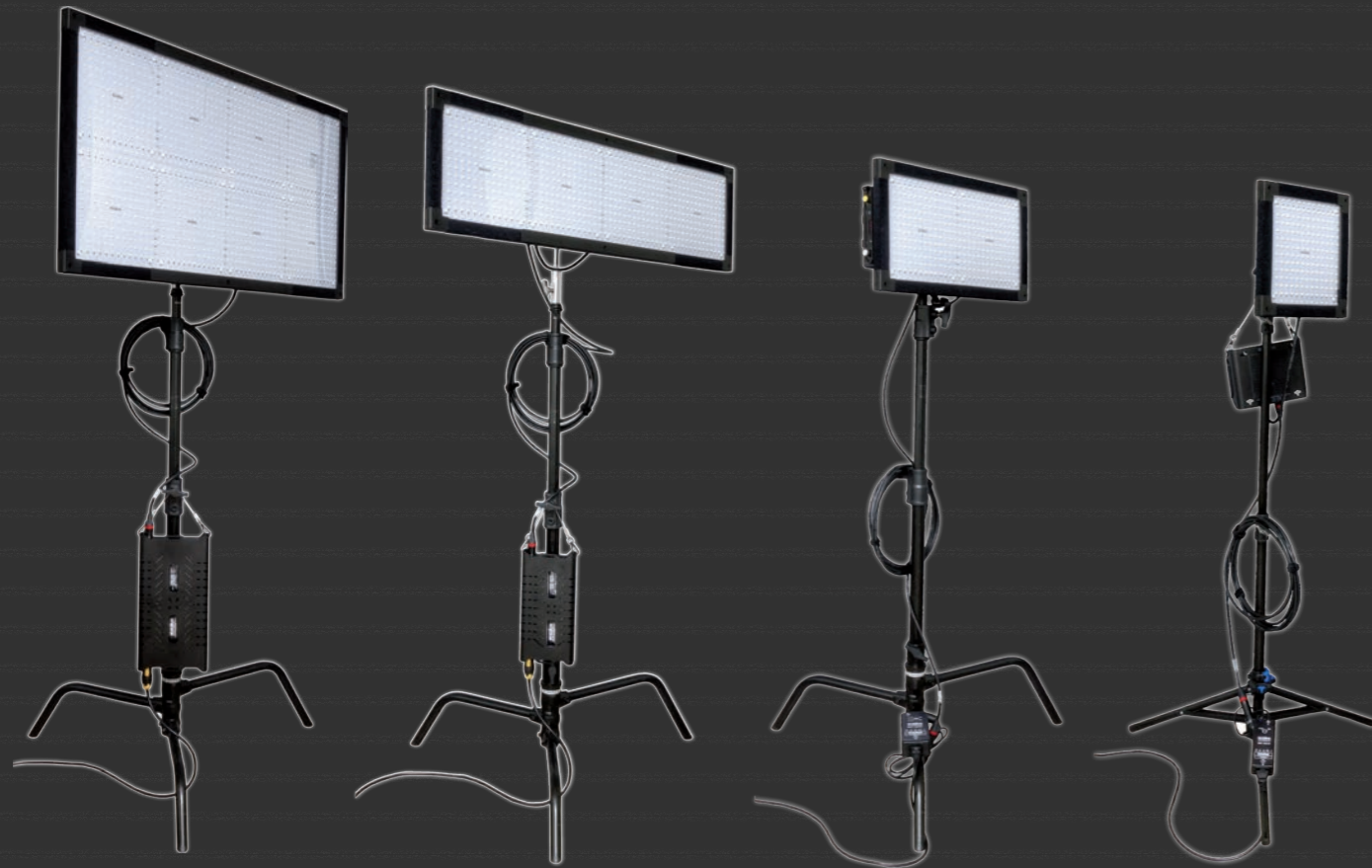

LEDZEP PUNCH
1X1TW2765

LEDZEP PUNCH
1X2TW2765

LEDZEP PUNCH
1X4TW2765

LEDZEP PUNCH
2X4TW2765



LEDZEP PUNCH 1X1TW2765

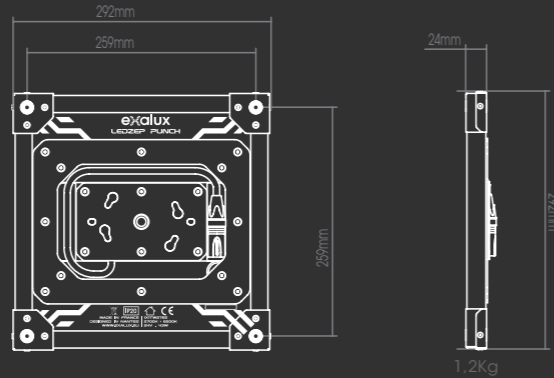

ELECTRICAL DATA

Input Voltage (PWM)	24VDC
Power Consumption	
@2700K	43W
@6500K	33W

COMPLIANT DIMMERS

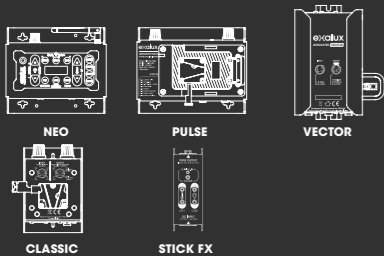

PHOTOMETRIC DATA

CCT	2 700K ± 5%	6 500K ± 5%
Flux (lm)	3 088 ± 5%	2 924 ± 5%
duv	-2.60 ⁻⁰³ ± 5%	2.89 ⁻⁰⁵ ± 5%
Efficiency (lm/w)	69,13 ± 5%	86,52 ± 5%
Angle / Fwhm (°)	60	60
Colour rendering		
Ra	96	97
R9	98	87
R13	95	97
R15	97	94
TLCI	99	99
TM30-18	94	93

ILLUMINANCE (LUX)

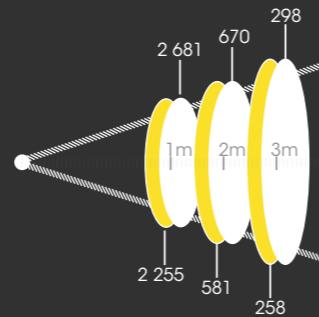

LEDZEP PUNCH 1X2TW2765

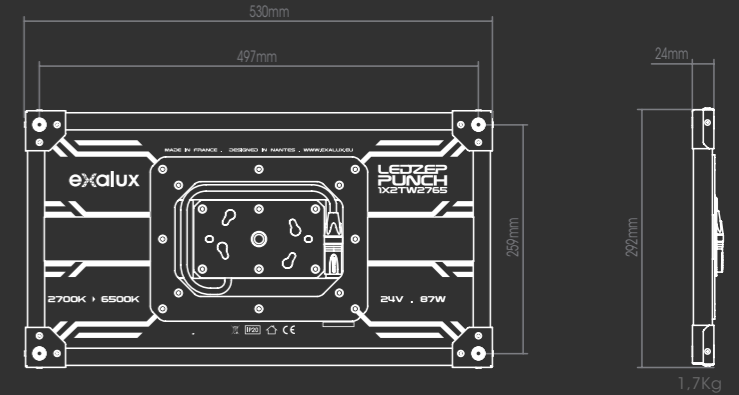
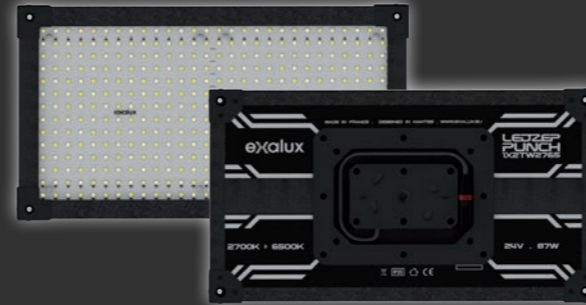

ELECTRICAL DATA

Input Voltage (PWM)	24VDC
Power Consumption	
@2700K	86W
@6500K	66W

COMPLIANT DIMMERS

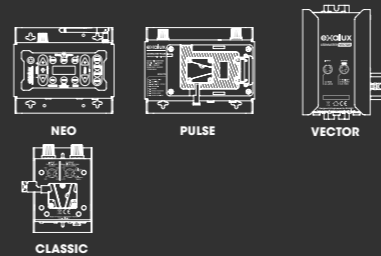

PHOTOMETRIC DATA

CCT	2 700K ± 5%	6 500K ± 5%
Flux (lm)	6 175 ± 5%	5 848 ± 5%
duv	-2.60 ⁻⁰³ ± 5%	2.89 ⁻⁰⁵ ± 5%
Efficiency (lm/w)	69,13 ± 5%	86,52 ± 5%
Angle / Fwhm (°)	60	60
Colour rendering		
Ra	96	97
R9	98	87
R13	95	97
R15	97	94
TLCI	99	99
TM30-18	94	93

ILLUMINANCE (LUX)

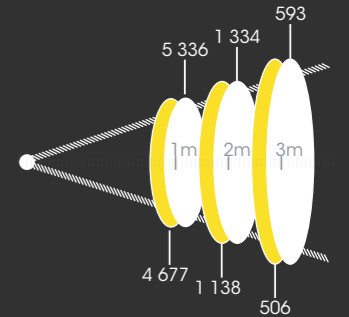

LEDZEP PUNCH 1X4TW2765

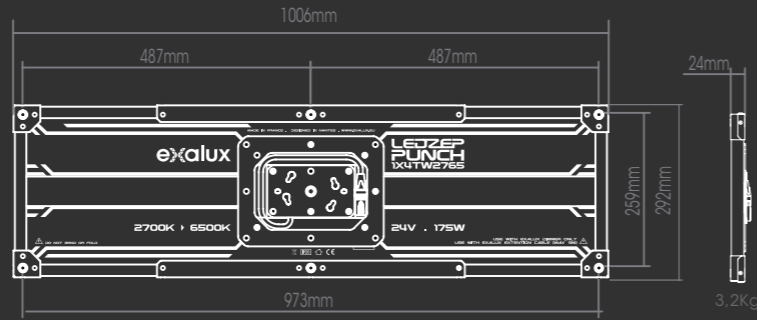

ELECTRICAL DATA

Input Voltage (PWM)	24VDC
Power Consumption	
@2700K	173W
@6500K	132W

COMPLIANT DIMMER



PHOTOMETRIC DATA

CCT	2 700K ± 5%	6 500K ± 5%
Flux (lm)	12 350 ± 5%	11 696 ± 5%
duv	-2.60 ⁻⁰³ ± 5%	2.89 ⁻⁰⁵ ± 5%
Efficiency (lm/w)	69,13 ± 5%	86,52 ± 5%
Angle / Fwhm (°)	60	60
Colour rendering		
Ra	96	97
R9	98	87
R13	95	97
R15	97	94
TLCI	99	99
TM30-18	94	93

ILLUMINANCE (LUX)

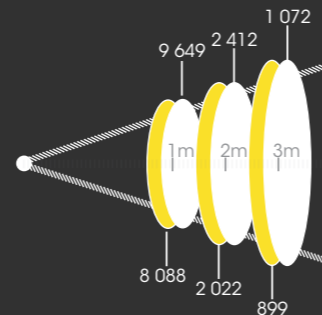

LEDZEP PUNCH 2X4TW2765

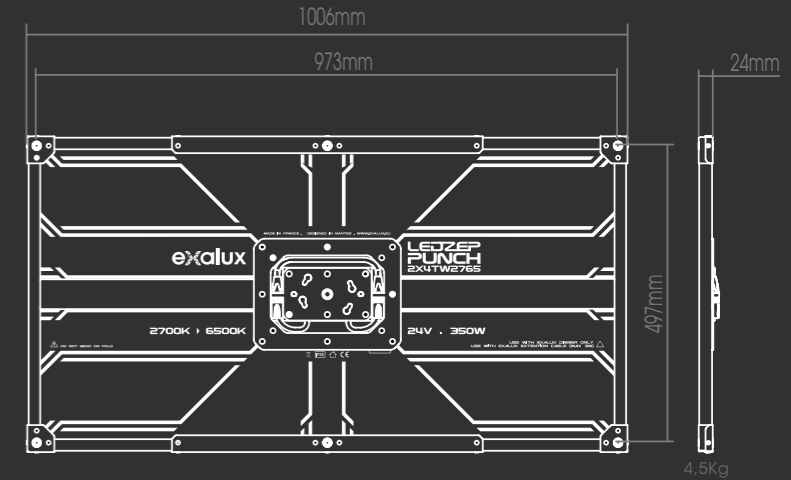
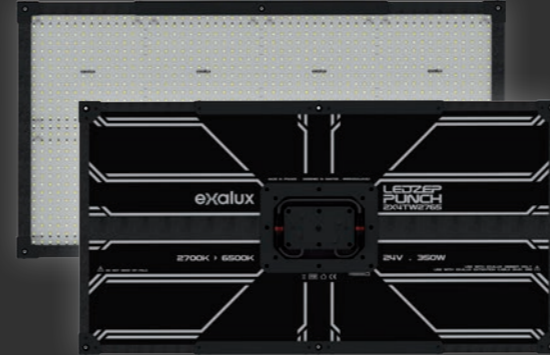

ELECTRICAL DATA

Input Voltage (PWM)	24VDC
Power Consumption	
@2700K	345W
@6500K	265W

COMPLIANT DIMMER



PHOTOMETRIC DATA

CCT	2 700K ± 5%	6 500K ± 5%
Flux (lm)	24 704 ± 5%	23 392 ± 5%
duv	-2.60 ⁻⁰³ ± 5%	2.89 ⁻⁰⁵ ± 5%
Efficiency (lm/w)	69,13 ± 5%	86,52 ± 5%
Angle / Fwhm (°)	60	60
Colour rendering		
Ra	96	97
R9	98	87
R13	95	97
R15	97	94
TLCI	99	99
TM30-18	94	93

ILLUMINANCE (LUX)

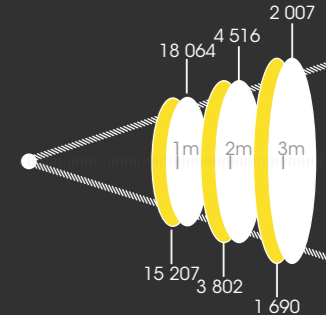

SHAPE YOUR LIGHT | GET THE FULL LIGHT CONTROL

Shaping light has never been easier thanks to the wide range of DpP choice and ZEPELIN™ diffusers. As easy as 1,2,3. DoPchoice SNAPGRIDS® mount on the front of a SNAPBOX® or a ZEPELIN™ diffuser to control the spread of the light.



SNAPBOX® by
DoPchoice®

SNAPGRID® by
DoPchoice®

ZEPELIN™ by
EXALUX

ZEPELIN™ | INFLATABLE DIFFUSER



ZEPELIN™ is an inflatable diffuser designed to add a magic touch to skin tones, in close up situation, especially to light up skins.

ZEPELIN™ by EXALUX™,
The amazing diffuser that adds
a magic touch to skin tones.



ACCESSORIES

CLAMPS



TWIST-ON PLATE

REF : ACC.007.001

Mounting plate to attach fixtures to a griphead. Feature a steel ball head well-welded with the 10mm knurled rod for the maximum strength.



SK MOUNTING PLATE

REF : ACC.007.014

Mounting plate to attach fixtures to any grip equipments comes with 5/8" (16mm) stud. Features double socket arm with balls and central knob allow a lock positively with one clamping action.



GOOSE-NECK PLATE

REF : ACC.007.015

Mounting plate to attach fixtures to any standard 16mm spigot. Features a steel ball head well-welded with the offset adapter for the maximum strength and offers the excellent balance for the weight of fixture on the center of the stand.

CABLES



XLR4 EXT. CABLE (2M)

REF : COR.001.021,

2m Extension Cable, NEUTRIK XLR4 male to XLR4 Female.



XLR4 EXT. CABLE (5M)

REF : COR.001.023,

5m Extension Cable, NEUTRIK XLR4 male to XLR4 Female.



POWER CABLE (1,8m)

REF: COR.000.002 (EU), COR.000.003 (UK)

COR.000.004 (JP/US),
COR.000.007 (AU/CN)

1,8m powerCON TRUE1 cable.

20

BAGS



LEDZEP 1X2 BAG

REF : EMB.005.003

Up to 2pcs per bag.



LEDZEP 1X4 BAG

REF : EMB.005.001

Up to 2pcs per bag.



LEDZEP 2X4 BAG

REF : EMB.005.002

Up to 2pcs per bag.

OTHERS



SLING

REF : EMB.007.016

Aluminium Sling,
Cable length : 250mm.

LEDZEP™ | KITS

LEDZEP 1X1 | ONE

REF : LZP.102.001



Extension cable (5m)



60W PSU



DoPchoice® SNAPBOX® & diffuser



LEDMASTER™ PULSE



SK mounting plate

LEDZEP 1X2 | ONE

REF : LZP.101.001



Extension cable (5m)



60W PSU



DoPchoice® SNAPBOX® & diffuser



LEDMASTER™ PULSE



SK mounting plate

LEDZEP 1X4 | ONE

REF : LZP.100.001



extension cable (5M)



extension cable (2M)



Power cable (1.8M)



DoPchoice® SNAPBOX® & diffuser



LEDMASTER™ NEO



200W PSU



Twist-On plate

LEDZEP 2X4 | ONE

REF : LZP.103.001



extension cable (5M)



extension cable (2M)



Power cable (1.8M)



DoPchoice® SNAPBOX® & diffuser



LEDMASTER™ NEO



400W PSU



Twist-On plate

DIMMING

In the EXALUX universe, you can use our dimmers with any head as long as the wattage is matched. That's a real benefit on set !

Our LEDMASTER range are famous for the smooth dimming and the fine tuning.

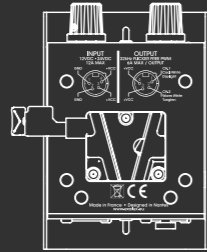

CLASSIC

REF : LMA.001.001
144W max output,
Analog control,
Tunable/dual channel mode.

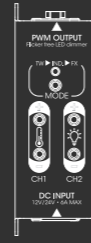

STICK FX

REF : LMA.001.002,
72W max output,
Analog control,
Tunable/dual channel / FX mode .

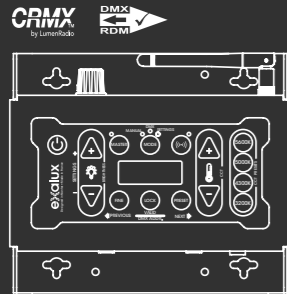

NEO

REF : LMA.001.012
240W+240W max output,
DMX512,
RDM ANSI E1.20,
CRMX by LumenRadio™.

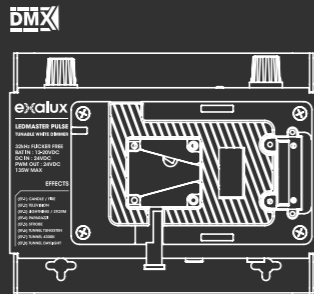

PULSE

REF : LMA.001.007
135W max output,
DMX512,
V-lock input.

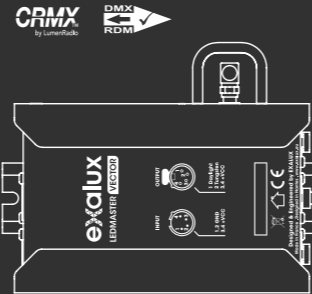

VECTOR

REF : LMA.001.010
120W+120W max output,
DMX512,
RDM ANSI E1.20,
CRMX by LumenRadio™,
X-LINK remote Input (RJ45).

POWER

We have created EXAWATT™, to give you the best energy to power your LEDZEP!

EXAWATT™ range is made of rugged power supplies and a battery-powered standalone station.

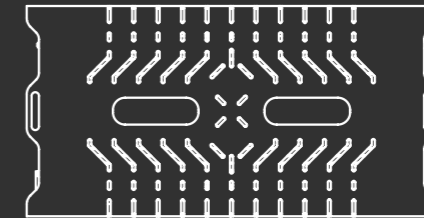

PSU-400-24

REF : PSU.001.048
24VDC / 400W / 16.7A,
Rugged Power Supply,
110-230VAC / 6.30A max input,
powerCON input & output,
3/8" adapter + aluminium sling.

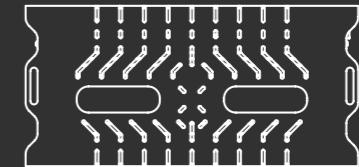

PSU-200-24

REF : PSU.001.047
24VDC/ 200W / 8.3A,
Rugged Power Supply,
110-230VAC / 2.5A max input,
powerCON input & output,
3/8" adapter + Aluminium sling.

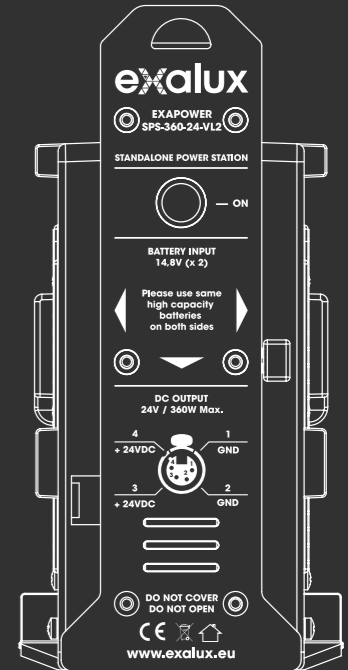

SPS-360-24-VL2

REF : PWR.024.004
24VDC/ 360W/15A,
StandAlone Power Station,
10-17VDC battery input (v-lock),
XLR4 female output,
3/8" adapter + aluminium sling.

MORE | OF EXALUX

Control



CONNECT ONE

REF : CTL.002.000
All-in-one DMX console,
Designed for all DMX devices,
DMX512 / 1 univers,
CRMX by LumenRadio™.



CONNECT SKY

REF : CTL.002.005
All-in-one DMX console,
Designed for the ARRI SkyPanel,
DMX512 / 1 univers,
CRMX by LumenRadio™.

Power



SPS-360-24-VL2

REF : PWR.024.004
24VDC / 400W / 15A,
StandAlone Power Station,
XLR4 female output.

Connect



RX200N

REF : CNT.002.001
RDM/DMX Wireless receiver,
CRMX by LumenRadio™,
5-24VDC input.



RX100S

REF : CNT.000.005,
DMX Wireless receiver,
CRMX by LumenRadio™,
5VDC input.

ABOUT EXALUX

Here at EXALUX™, innovation is at the heart of our strategy. We stand out for our ability to anticipate trends and establish links between needs and technology.

We specialise in designing distinctive lighting, lighting-control solutions and technologies for the film and broadcasting industries.

EXALUX™ has developed its business based on values that have helped make our products a success.

Innovation, technology, and passion.

The way we develop our products is by aiming to exceed expectations, with a focus on user-friendliness, design and performance.

Our philosophy is founded on the scalability of solutions and the ability to adapt to both customer needs and environmental constraints. All our products are engineered and made in France with passion.

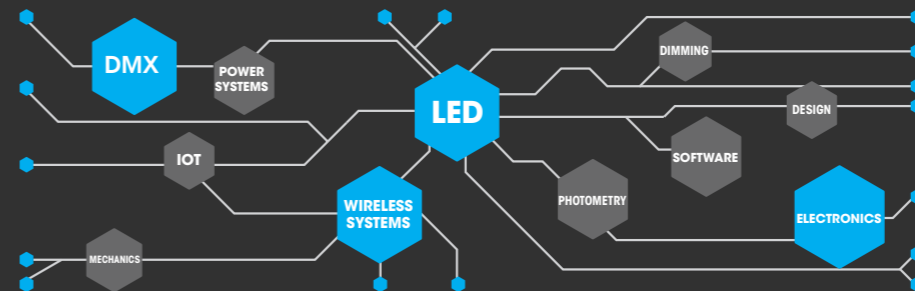

exalux

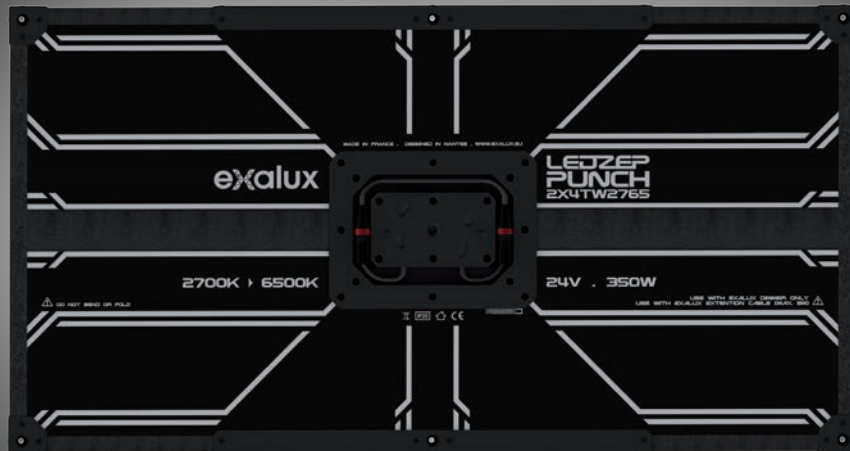

 **FRAMELIGHT**

sales@framelight.com.au | framelight.com.au