

NOUHAUS ERGONOMIC OFFICE CHAIR USER MANUAL

Wave



H.Q

NOUHAUS Inc.
10985 Oleander Ave. Fontana, CA 92337

Customer Service Center

10985 Oleander Avenue Fontana, CA 92337
support@nouhaus.com
+1 (888) 387-5949

Subscribe

W nouhaus.com

▶ Nouhaus

@ @nouhaus

f @nouhaus_official

P Nouhaus

t @nouhaus



NOUHAUS

NOUHAUS ERGONOMIC OFFICE CHAIR USER MANUAL

●
Thank you for purchasing the NOUHAUS Ergonomic Office Chair.
Please read this manual carefully before using.
Retain this manual for your reference.

This user manual contains the product warranty information.
The design and/or specification of this product is subject to change without notice.



Scan QR code to Watch our Assembly Video

CONTENTS

01	Instructions on Safe Use	Pg 05
02	Assembly Parts	Pg 06
03	How to Assemble	Pg 07
04	How to Use	Pg 09
05	Product Specifications and Information	Pg 11
06	Customer Service Information	Pg 12
07	Product Warranty	Pg 13













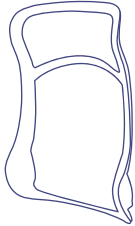



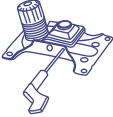

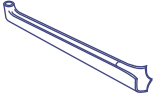
PLEASE READ

1. Do not discard any of the packaging until you are certain that you have all the necessary parts for the assembly.
2. Please ensure that the packaging is disposed of in a safe and environmentally responsible way.
3. During assembly, tighten screws by hand only. Once all screws are in place, you may tighten all screws completely.



CAUTION

1. NEVER use this chair as a step ladder.
2. Check that screws have not become loosened every 6 months. Retighten if necessary.
3. Do not allow children to play with or operate the mechanism.
4. Keep hands and feet clear of the mechanism.
5. Only the occupant should operate mechanism.

(A) Chair Back x1 		(B) Chair Seat x1 			
(C) Arms Base Left x1 Right x1 			(D) Arms Left x1 Right x1 		
(E) Seat Mechanism x1 		(F) Gas Lift x1 		(G) Base Legs x5 	
(H) Base Center x1 		(I) Casters x5 		(J) x5  M6 x 0.98"	(K) x2  M6 x 1.77"
(L) x2  Washer	(M) x2  Gasket	(N) x4  M6 x 1.37"	(O) x4  M6 x 0.78"	(P) x4  M6 x 0.98"	(Q) x1  Allen Wrench

*Extra screws included

Tools Needed: Allen Wrench - Provided
Please read all instructions before assembly

Step 1

Connect and attach Base Legs (G) to Base Center (H) using M6x0.98" Screws (J). Tighten with Allen Wrench (Q). Insert Casters (I) into Base Legs (G).

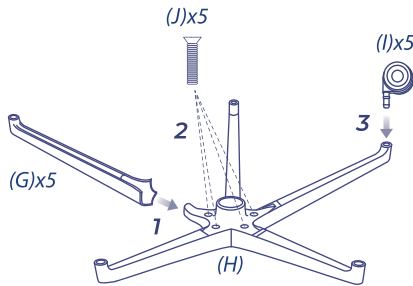

Step 2

Insert Gas Lift (F) into the hole of the Base Center (H). Remove the cover from the tip of the gaslift.

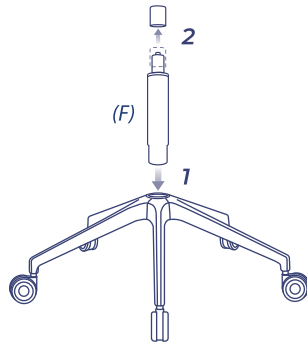

Step 3

Align and connect Arms (D) to the Arm Base (C) using M6x1.77" Screws (K), Washers (L) and Gaskets (M). Tighten with Allen Wrench (Q).

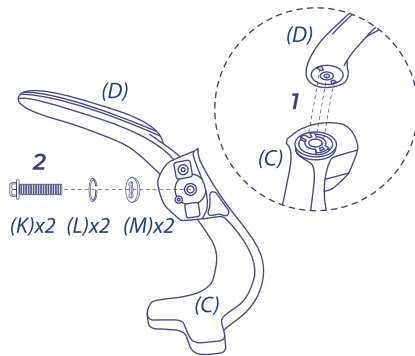

Step 4

Attach Arm Bases (C) to both sides of the Chair Seat (B) using M6x1.37" Screws (N). Tighten with Allen Wrench (Q) only 50%.

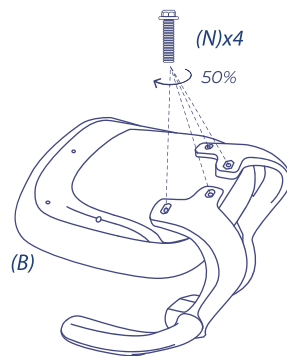

Step 5

Attach Chair Back (A) to Arm Bases (C) using M6x0.78" Screws (O). Tighten with Allen Wrench (Q).

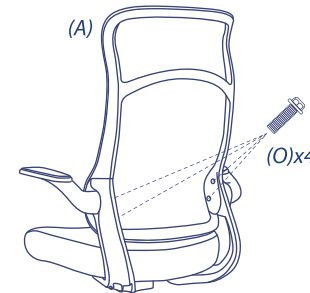

Step 6

Tighten the screws from Step 4 with Allen Wrench (Q) 100%.

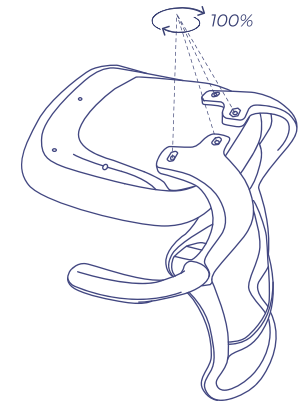

Step 7

Attach Seat Mechanism (E) to Chair Seat (B) using M6x0.98" Screws (P). Tighten with Allen Wrench (Q).

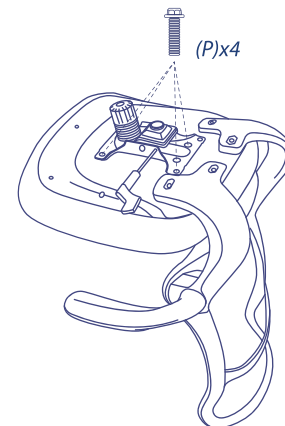

Complete!

Carefully place the assembled Chair Frame onto the Gas Lift (F). Aligning the hole into the Seat Mechanism (E) on the Chair Seat (B) with the Gas Lift (F). Press down on the Chair Seat (B) to secure in place.

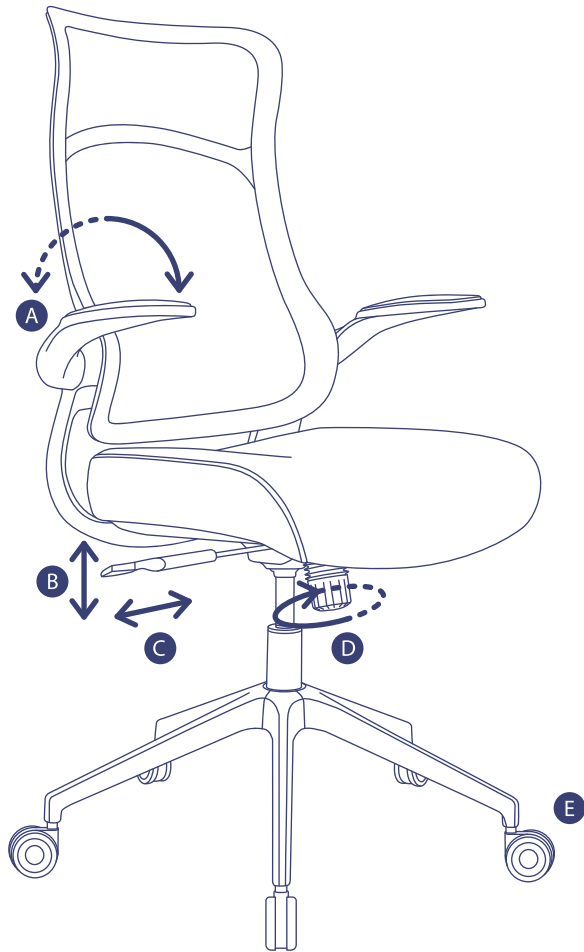

**A FOLDABLE ARMRESTS**

Fold up and down to better suit your sitting preference.

B HEIGHT

Right handle (while seated): Pull the 'flap' of the handle up to adjust the height of the chair.

C TILT MECHANISM

Right handle (while seated): Push inwards/pull outwards to lock/unlock the tilt mechanism.

*One locking position: upright

D TILT TENSION

Turn the knob clockwise to loosen the tilt tension of the chair, counterclockwise to tighten. Adjust according to your own preference.

E WHEELS

Suitable for carpet, chair mats, soft floors, and hardwood floors.

Product Name	Nouhaus Wave
Model Number	NHO-0009
Chair Dimensions	W26.38 x D25.59 x H44.09/47.05 in
Seat Depth	16.93 in
Max Hip Width	20.31 in
Net Weight	28.22 lbs
Gross Weight	34.39 lbs
Weight Capacity	85 lbs - 275 lbs
Height Capacity	5'4" – 6'3"
Fabric	HD ElastoMesh Back, ElastoFabric Seat with PP Armrests
Wheels	50R Hollow Wheels
Base	KD Aluminum Alloy
Customer Service	support@nouhaus.com 10985 Oleander Ave. Fontana, CA 92337 +1(888)387-5949

NOUHAUS office chairs are warranted for a period of THREE years against

1. Missing materials from the Product at the time of delivery;
2. Defects in the manufacturing of materials used for the Products at the time of delivery;
3. Failure of the Products to correspond with the description in the applicable contract of sale at the time of delivery; and
4. Major defects in the functional department, such as :
 - a. Skeletal frame failure
 - b. Casters mechanism failure
 - c. Tilt mechanism failure
 - d. Gas lift failure
 - e. Armrest mechanism failure

Subject to the following:

Any replacement parts shall be sent to the address of the original purchaser, replaced parts may be required to be shipped back to NOUHAUS at its discretion; to benefit under this warranty, NOUHAUS must be notified of any defect within 14 days of the occurrence of such defect via an image or video of the relevant defect sent electronically to support@nouhaus.com, and after inspection and acceptance by NOUHAUS; to the extent permitted under the applicable Federal and State law of the United States of America, all parts replaced or repaired under this warranty shall be warranted for the remainder of the designated Warranty Period.

What Our Warranty Does Not Cover

All warranties listed on this page exclude the following where permitted under the applicable Federal and State law of the United States of America:

1. Excludes normal wear and tear of surfaces that are not attributable to manufacturing, including but not limited to (a) degradation of upholstery (PU leather / fabric / genuine leather / mesh), top portion of armrests, pillows, casters exterior or mesh stitching, (b) damage to plastic coverings, (c) variance of tightness of mechanisms, and (d) excludes damage from accidents, natural disasters, physical damage from pets, fire and flood, and non-manufacturing incidents covered under insurance policies (regardless of whether you are in possession of the relevant insurance), (e) excludes any variations in dimensions and color;
2. Any claims for indirect, consequential or incidental losses.
3. Damage to a product that has been modified or altered without the written permission of NOUHAUS;
4. Damage caused to all NOUHAUS products during self-assembly due to failure to adhere to the relevant self-assembly manual instructions provided;
5. Minor misalignments, variations arising out of hand-made workmanship. To ensure your product enjoyment and safety, and protection under the "Warranty Period", please ensure you have NOUHAUS assembly and care guidelines for this product, and follow them for the correct assembly and care for your item. Contact our Customer Service Team to obtain these guidelines if you do not have them.

07 Product Warranty

For warranty information, please visit the Warranty page at www.nouhaus.com



NOUHAUS, Inc.
10985 Oleander Ave.
Fontana, CA 92337

Product Information

Product Name	Model Number
Manufacture Date	Manufacture Number
Purchase Store	Purchase Store Contact
Date of Purchase	Order Number
Date of Installation	Warranty Date

Customer Information

Name
Contact
Address
