

LEITNER

ACSROOF

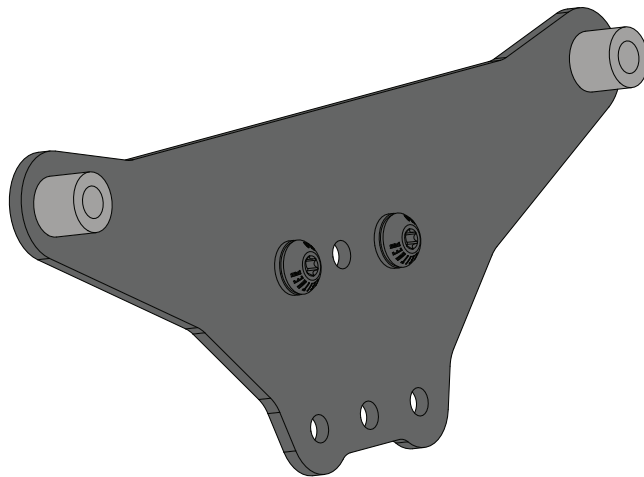
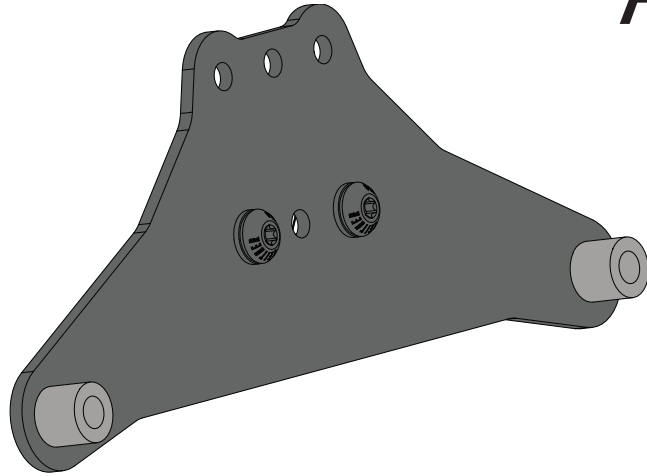

ROOF MAXTRAX BRACKETS

LEITNERDESIGNS.COM | SALES@LEITNERDESIGNS.COM | 949-395-3049

ASSEMBLY / INSTALLATION INSTRUCTIONS:

PART NUMBER:

00-RMA-1633

TOOLS REQUIRED

- T40 TORX
- 17MM WRENCH
- 21MM WRENCH

INSTALLATION TIME

25-30 MINUTES

BASIC KNOWLEDGE OF HAND TOOLS REQUIRED

SKILL LEVEL



2= NOVICE

▼ MAXTRAX HARDWARE ▼

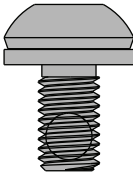

M8 X 14
(X4)

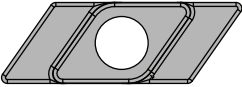

TRAKLOK NUT
(X4)

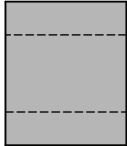

MAXTRAX PIN SPACER
(X4)

▼ READ BEFORE INSTALLING ▼

1. DON'T OVER-TIGHTEN BOLTS. ALL 8MM BOLTS = (16FT-LB)
3. LAY DOWN A LARGE AREA OF CARPET OR BLANKETS AS A WORK AREA TO AVOID SCRATCHING PARTS DURING ASSEMBLY.
5. TAKE YOUR TIME TO DO IT RIGHT.

▼ ASSEMBLY OVERVIEW ▼

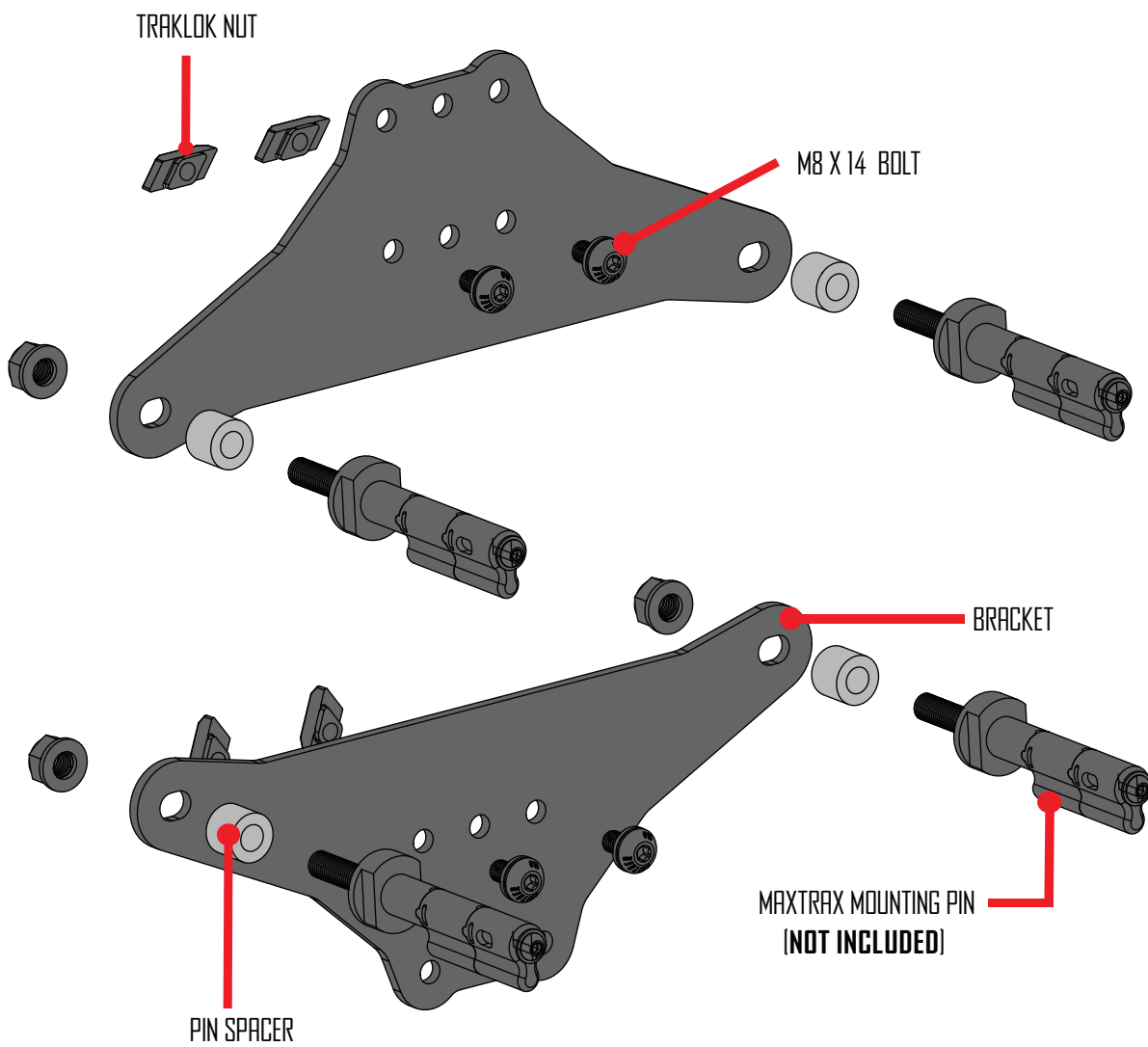

ATTACH PINS TO BRACKET: TIGHTEN M10 NUTS

- ATTACH A PIN AS SHOWN TO EACH OF THE FOUR HOLES IN THE BRACKETS USING THE WASHERS AND M10 LOCK NUT (**NOT INCLUDED IN KIT**).
- PIN SPACERS ARE OPTIONAL BUT ALLOW THE MAXTRAX BOARDS TO BE MOUNTED ABOVE THE OUTSIDE RAILS OF THE RACK.
- TIGHTEN THE M10 NUT USING A 17MM WRENCH WHILE HOLDING THE FLATS ON THE PIN WITH A 21MM WRENCH.

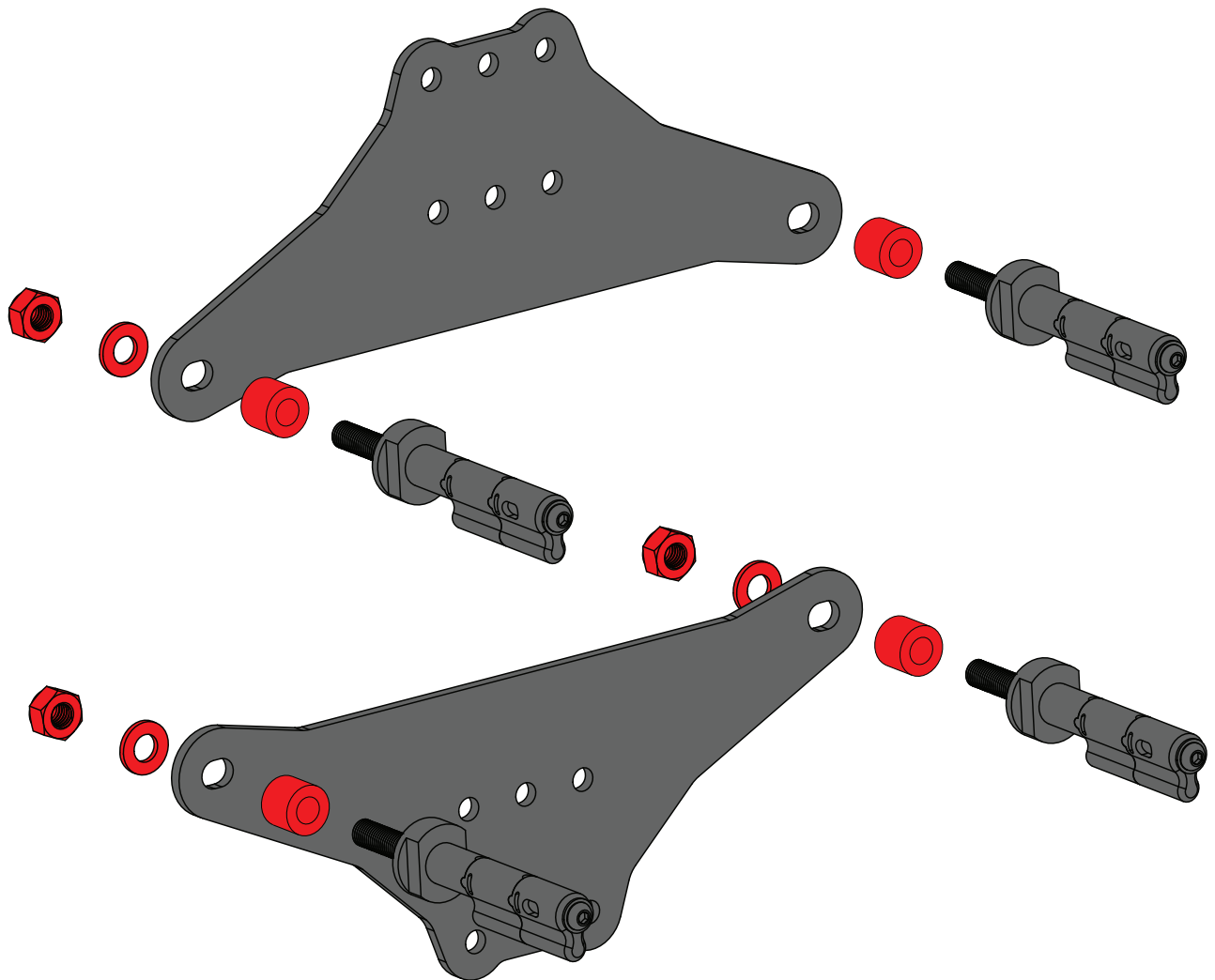

INSTALL: MOUNTS TO RACK

• ATTACH THE MOUNTS TO THE RACK USING ANY OF THE 6 HOLES PROVIDED USING THE M8 X 14 SCREW AND TRAKLOKS.

• **NOTE: IT IS EXTREMELY IMPORTANT THAT THE TRAKLOK NUTS ROTATE FULLY INTO PLACE AS SHOWN IN DIAGRAM AND TIGHTEN DOWN UNDER THE LIP OF THE ALUMINUM EXTRUSION.**

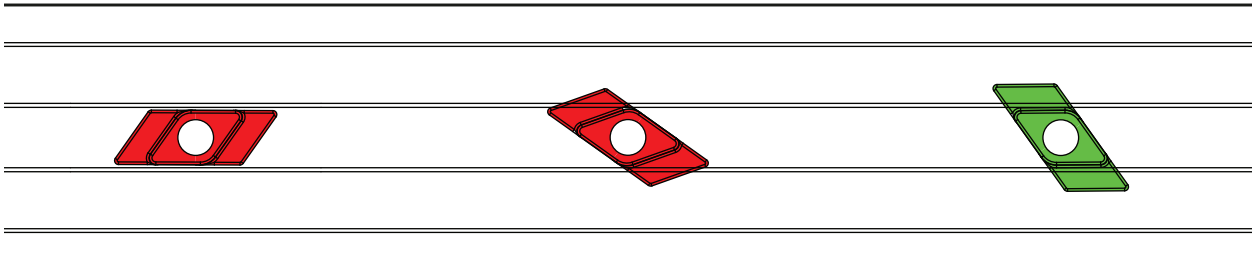
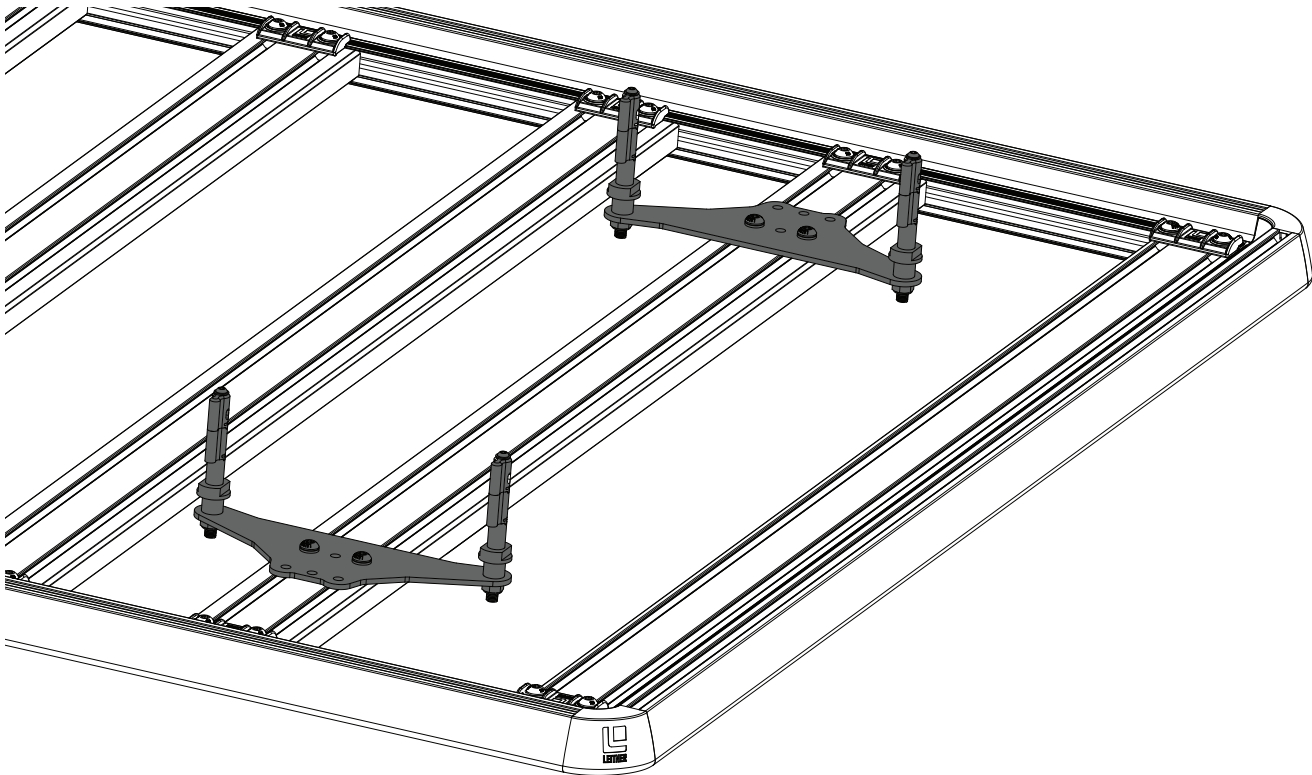

BAD

BAD

GOOD

USE GUIDELINES

WHEN USING LEITNER DESIGNS CARRIERS AND ACCESSORIES, THE USER MUST UNDERSTAND THE PRECAUTIONS. THE POINTS LISTED BELOW WILL ASSIST YOU IN USING THE RACK SYSTEM AND WILL ENCOURAGE SAFETY.

-FOR QUALITY FITS AND SAFETY, USE ONLY THE RECOMMENDED RACK OR ACCESSORIES. DO NOT ASSUME A RACK WILL FIT, ALWAYS CHECK THE CURRENT FIT GUIDE WHEN OBTAINING A NEW VEHICLE.

-THE MAXIMUM LOAD IS NOT TO BE EXCEEDED. (250# OFF ROAD – 500# ON ROAD). HOWEVER, THIS LIMIT IS ALWAYS SUBORDINATE TO THE MAXIMUM LOAD RECOMMENDED BY THE MANUFACTURER OF THE VEHICLE ITSELF. IT IS ALWAYS THE LOWER MAXIMUM RECOMMENDED LOAD THAT APPLIES. $\text{MAX TRUCK LOAD} = \text{LOAD CARRIER WEIGHT} + \text{ANY FITTED CARRIER ACCESSORIES} + \text{THE WEIGHT OF THE LOAD ITSELF}$.

-HIGH SPEED OFF ROAD DRIVING EVEN WITH A LIGHT LOAD CAN CAUSE DAMAGE TO THE RACK, ACCESSORIES AND VEHICLE BODY. DAMAGE CAUSED BY HIGH SPEED DRIVING AND ABUSE IS NOT COVERED UNDER WARRANTY.

-MAKE SURE ALL KNOBS, BOLTS, SCREWS, STRAPS, AND LOCKS ARE FIRMLY ATTACHED, TIGHTENED AND LOCKED BEFORE EVERY TRIP. KNOBS, BOLTS, SCREWS, STRAPS AND LOCKS MUST BE PERIODICALLY INSPECTED FOR SIGNS OF WEAR, CORROSION, AND FATIGUE. CHECK YOUR LOAD AT STOPS DURING THE TRIP TO ENSURE CONTINUED FASTENING SECURITY.

-CHECK LOCAL AND STATE LAWS GOVERNING PROJECTION OF OBJECTS BEYOND THE PERIMETER OF A VEHICLE. BE AWARE OF THE WIDTH AND HEIGHT OF YOUR CARGO SINCE LOW CLEARANCE BRANCHES, BRIDGES, AND PARKING GARAGES CAN AFFECT THE LOAD. ALL CARGO WILL AFFECT THE VEHICLE'S DRIVING BEHAVIOR. NEVER DRIVE WITH ANY LOCK, KNOB OR RACK IN AN OPEN OR UNLOCKED POSITION. ALL LONG LOADS SUCH AS, BUT NOT LIMITED TO, SAILBOARDS, SURFBOARDS, KAYAKS, CANOES, AND LUMBER MUST BE TIED DOWN FRONT AND REAR TO THE BUMPERS OR TOW HOOKS OF THE VEHICLE.

-ALL LOCKS MUST BE TURNED AND MOVED PERIODICALLY TO ENSURE SMOOTH OPERATION. USE GRAPHITE OR DRY LUBRICANT TO HELP THIS. LEITNER DESIGNS LOCKS ARE DESIGNED TO DETER VANDALISM AND THEFT BUT SHOULD NOT BE CONSIDERED THEFT PROOF. REMOVE VALUABLE GEAR IF YOUR VEHICLE IS UNATTENDED FOR AN EXTENDED PERIOD. PLACE AT LEAST ONE KEY IN THE GLOVE COMPARTMENT.

-FOR SAFETY TO YOUR VEHICLE AND RACK SYSTEM, OBEY ALL POSTED SPEED LIMITS AND TRAFFIC CAUTIONS. ADAPT YOUR SPEED TO THE CONDITIONS OF THE ROAD AND THE LOAD BEING CARRIED.

-DO NOT USE LEITNER DESIGNS LOAD CARRIERS AND ACCESSORIES FOR PURPOSES OTHER THAN THOSE FOR WHICH THEY WERE DESIGNED. DO NOT EXCEED THEIR CARRYING CAPACITY. FAILURE TO FOLLOW THESE GUIDELINES OR THE PRODUCT'S INSTRUCTIONS WILL VOID THE WARRANTY.

WARRANTY

LEITNER DESIGNS WARRANTS PRODUCT TO BE FREE FROM DEFECTS IN MATERIAL AND WORKMANSHIP, FOR TERMS SPECIFIED BELOW, PROVIDED THERE HAS BEEN NORMAL USE AND PROPER MAINTENANCE. ALL REMEDIES UNDER THIS WARRANTY ARE LIMITED TO THE REPAIR OR REPLACEMENT OF ANY ITEM FOUND BY THE FACTORY TO BE DEFECTIVE WITHIN THE TIME PERIOD SPECIFIED. IF YOU HAVE A WARRANTY CLAIM, FIRST YOU MUST CALL OUR FACTORY AT THE NUMBER BELOW FOR INSTRUCTIONS. YOU MUST RETAIN PROOF OF PURCHASE AND SUBMIT A COPY WITH ANY ITEMS RETURNED FOR WARRANTY WORK. UPON COMPLETION OF WARRANTY WORK, IF ANY, WE WILL RETURN THE REPAIRED OR REPLACED ITEM OR ITEMS TO YOU FREIGHT PREPAID. DAMAGE TO OUR PRODUCTS CAUSED BY ACCIDENTS, FIRE, VANDALISM, NEGLIGENCE, MIS-INSTALLATION, MISUSE, ACTS OF GOD, OR BY DEFECTIVE PARTS NOT MANUFACTURED BY US, IS NOT COVERED UNDER THIS WARRANTY.

THE WARRANTY TIME PERIOD IS AS FOLLOWS: (2) TWO YEARS FROM DATE OF PURCHASE.

HIGH SPEED OFF ROAD DRIVING EVEN WITH A LIGHT LOAD CAN CAUSE DAMAGE TO THE RACK, ACCESSORIES AND VEHICLE BODY. DAMAGE CAUSED BY HIGH SPEED OFF ROAD DRIVING AND ABUSE IS NOT COVERED UNDER WARRANTY.

GEAR PODS ARE WATER RESISTANT AND NOT WATERPROOF. ITEMS THAT CAN BE DAMAGED BY WATER SHOULD BE STORED INSIDE THEIR OWN AIR TIGHT CONTAINER BEFORE BEING PLACED IN THE GEAR POD.

ANY IMPLIED WARRANTIES OF MERCHANTABILITY AND/OR FITNESS FOR A PARTICULAR PURPOSE CREATED HEREBY ARE LIMITED IN DURATION TO THE SAME DURATION AND SCOPE AS THE EXPRESS WRITTEN WARRANTY. OUR COMPANY SHALL NOT BE LIABLE FOR ANY INCIDENTAL OR CONSEQUENTIAL DAMAGE.

SOME STATES DO NOT ALLOW LIMITATIONS ON HOW LONG AN IMPLIED WARRANTY LASTS, OR THE EXCLUSION OR LIMITATION OF INCIDENTAL OR CONSEQUENTIAL DAMAGES, SO THE ABOVE LIMITATIONS OR EXCLUSIONS MAY NOT APPLY TO YOU. THIS WARRANTY GIVES YOU SPECIFIC LEGAL RIGHTS, AND YOU MAY ALSO HAVE OTHER RIGHTS THAT VARY FROM STATE TO STATE.

FOR WARRANTY ISSUES WITH THIS PRODUCT PLEASE CALL LEITNER DESIGNS CUSTOMER SERVICE **949-395-3049** OR EMAIL US AT **SALES@LEITNERDESIGNS.COM**