



bebcare

THERE BEYOND TOUCH



BEBCARE AIR

Portable Smart Baby Fan
with Air Purifier and Air Quality Sensor



Download on the
App Store



ANDROID APP ON
Google play

Thank you for purchasing our Bebcare Air baby fan. Your unit has been manufactured and checked under the strictest possible quality control to ensure that each fan leaves the factory in perfect condition. In the unlikely event you find any defects or have any problem, please contact your dealer, our branch or service center.

Please read this manual carefully to obtain maximum performance & extended service life from the unit.





Features

- 3 layers of composite filter that can filter off 100% PM2.5 particulates, 99.7% PM1.0 particulates, 99.5% flu virus, smoke, bad smell, VOC and formaldehyde
- Capable of delivering 1 cbm of clean air in 20 min
- Incorporate with PM2.5 air quality sensor, temperature and humidity sensor to provide full information about environmental condition
- Wind sweeping function that deliver gentle breeze to baby
- Night light with adjustable colour and intensity
- Lullaby playing to comfort baby
- Auto fan speed mode that deliver the most appropriate amount of clean air to baby according to environmental condition
- Manual mode with 3 adjustable fan speed
- Operate with Bebcare Air app showing historical air quality
- Incorporate with rechargeable Li battery that has running time of 8 hours with mid fan speed
- Extremely low noise level of only 50dB (measured at 1m distance) at highest fan speed and 28dB at lowest fan speed
- Easy to carry small size
- Mounting clip for stroller or cot use
- Auto reminder for filter changing

Warning

During the baby early months, we suggest to use the wind sweeping function and keep a distance of 30 - 40 cm between fan and baby since continuously blowing air towards baby may impair his breathing.

Power supply

This baby fan is incorporated with Li battery. Once the battery level is low, the LED below Power on/off  button  or Fan speed  button  will start flashing. Connect the supplied USB cable to USB-C port , the LED below will show pulsating, indicating the battery is under charging. Once the battery is fully charged up, the LED will light up steady.

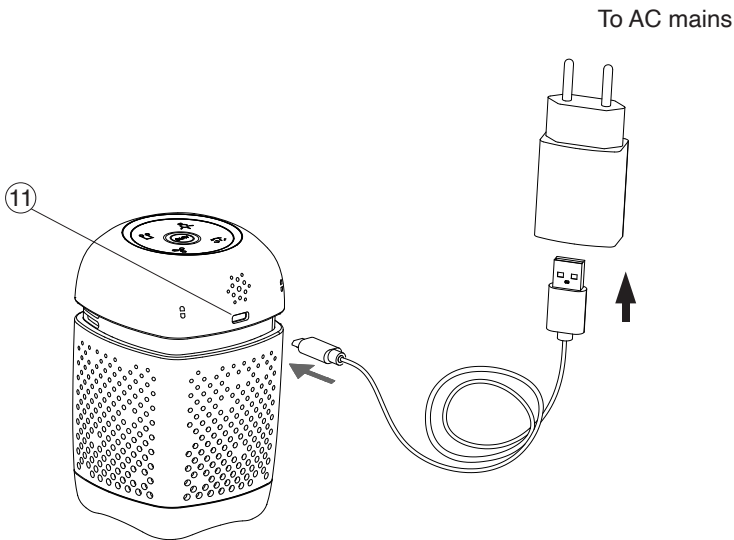

N.B. Before using the unit for the first time, fully charge up the Li battery for at least three hours with the unit being switched off. It will take longer time if the unit is switched on.



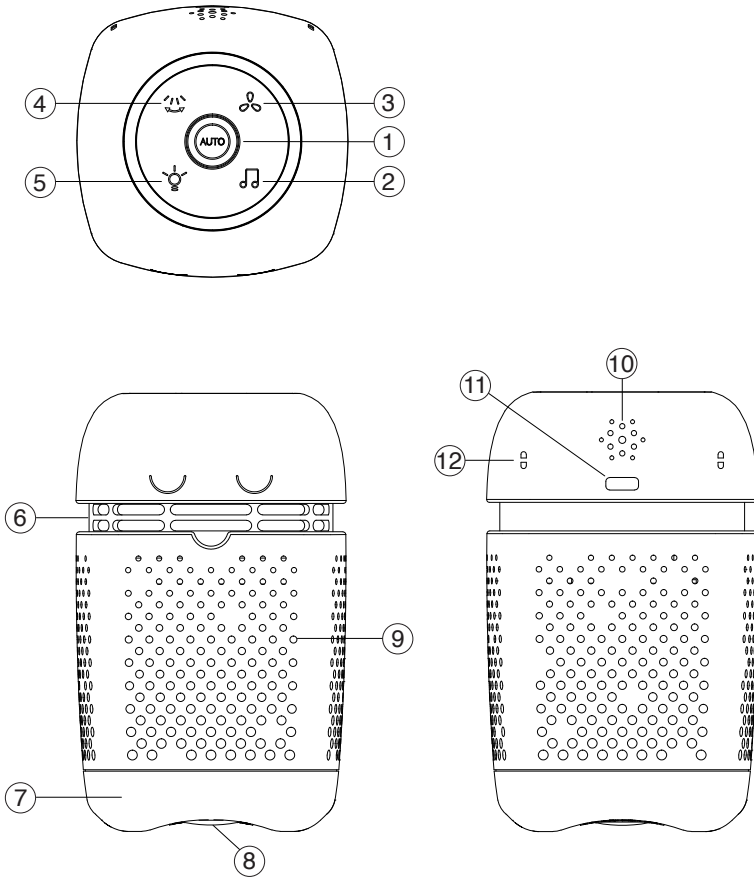



















Controls Layout



- ① Power On/OFF and Auto mode button
- ② Music button
- ③ Fan speed button
- ④ Wind sweeping button
- ⑤ Night light button
- ⑥ Clean air outlet

- ⑦ Air quality indicator/night light
- ⑧ Locking screw
- ⑨ Air intake holes for filter
- ⑩ Speaker
- ⑪ USB-C port
- ⑫ PM2.5 sensor air inlet

Operation

1. Long press power on/off  button  to switch on unit, the LED below will show steady blue. Once LED starts flashing, battery has run down and needs to be recharged. During charging process, LED will show pulsating and change back steady blue when battery becomes fully charged. To switch off unit, long press  button  again.
2. The unit now operates with Auto mode which means the fan speed will be automatically adjusted according to the environmental condition (PM2.5 index, temperature and humidity). This can ensure the most appropriate amount of clean air is delivered to baby.
3. Parents can switch to manual mode by short press fan speed  button . The LED below button will light up white. To change fan speed, short press  button  again, the LED intensity will change accordingly. Higher intensity means higher fan speed. There are total  speed for selection.
4. Short press  button  to switch back to auto mode, the LED below button will light up steady blue.
5. For baby to enjoy gentle breeze of clean air, short press  button  to switch on wind sweeping function. The LED below will light up white. When baby is newly born, we recommend to keep wind sweeping ON as continuously blowing air towards baby may impair his breathing. Short press  button  again to switch off wind sweeping.
6. The clean air blowing out from outlet  is filtered by a composite filter. This filter has 3 layers. The first layer is active carbon which eliminates all the bad smell, smoke, VOC and formaldehyde. The second layer filters off 99.5% of H1N1 flu virus and the third layer is a EPA filter that filters off 100% PM2.5 particulates and 99.7% PM1.0 particulates including pollen. After passing through the filter, it can be sure the air delivered to baby is purified, free from bad odour and flu virus.
7. Under normal working condition, the air quality indicator  will show pulsating and with colour representing the air quality index. Short press the night light  button  can switch indicator  to become night light and the LED below  button  will light up white. The colour and intensity of night light can be adjusted via the Bebcare Air app.

8. This baby fan is also incorporated with lullaby playing function to comfort baby. Short press music 🎵 button (2) to initiate lullaby playing, the LED below 🎵 button (2) will light up white. The lullaby volume heard in speaker (10) and selection of song is performed via the Bebcare Air app.
9. A PM2.5 sensor is built inside the unit to measure the air quality index. This sensor intake the surrounding air through inlet (12), so it is advisable not to block these holes for correct reading.
10. The filter intake air through the holes (9) on all four sides and then blow out the clean air from outlet (6). It is recommended not to block the holes (9) and outlet (6).
11. Once you switch off the unit, your settings will be memorized except the lullaby playing function which is always default as OFF.
12. The Bebcare Air app will automatically provide a reminder when it is time to replace filter, follow the below procedures to change filter :

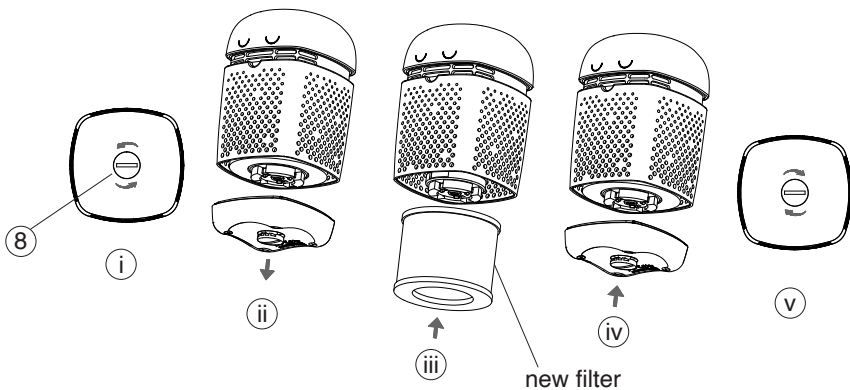

13. The supplied mounting kit operates as follow :
 - a. Engaging the clip to mount

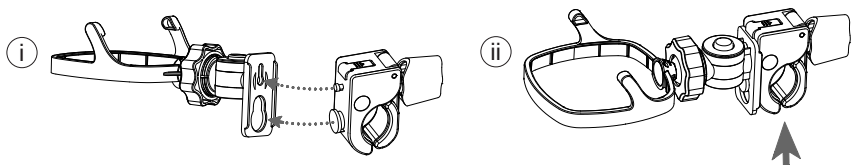

b. Disengaging the clip from mount

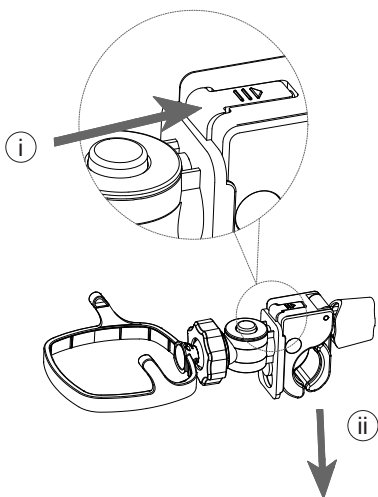

c. Installing the baby fan to mounting kit

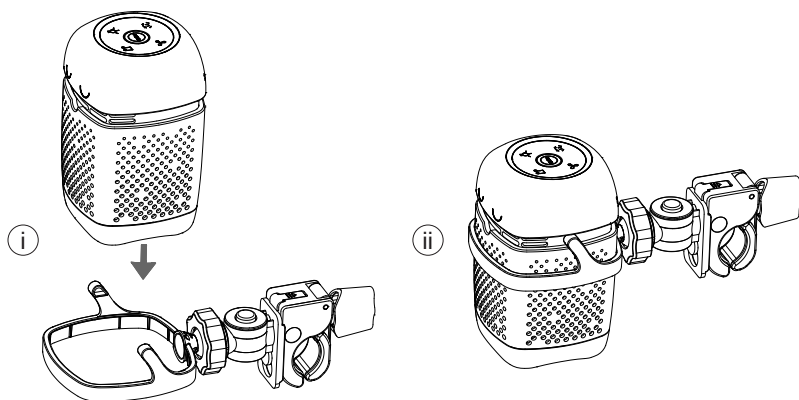

d. Installing the baby fan in stroller or cot

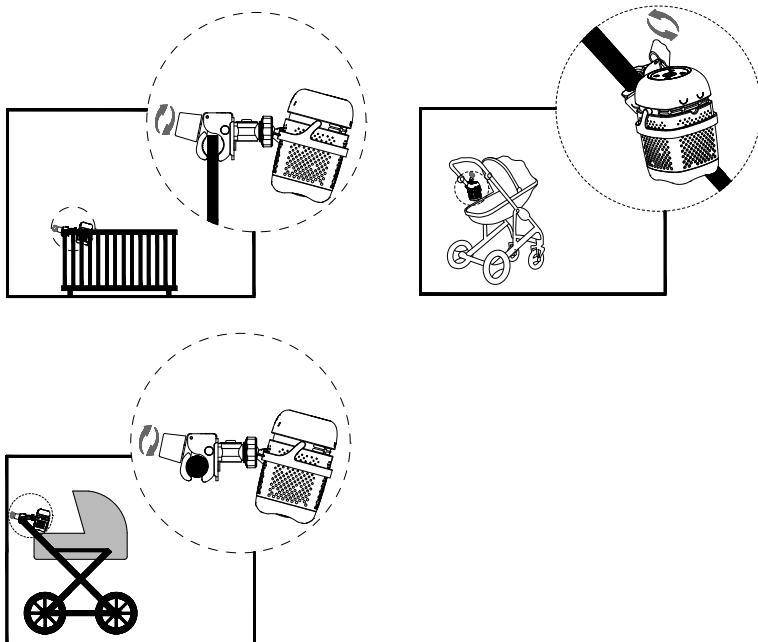

e. Moving the baby fan horizontally to face towards baby

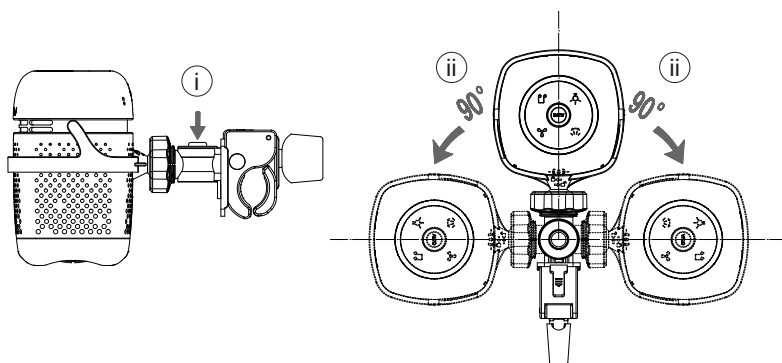

f. Loosen the screw nut to allow baby fan swivel in different direction

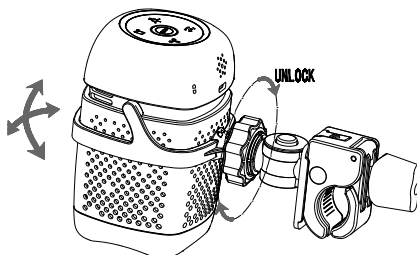

14. Download the Bebcare Air app  from Apple store or Google play. The operation of app as follow :

Getting Started with Bebcare Air

Portable comfort fan + air purifier for your baby

1

Download "Bebcare Air" app from Apple App Store.



Turn on the Bebcare Air fan + purifier by pressing and holding the middle button



2

Getting Started with Bebcare Air

Portable comfort fan + air purifier for your baby

3

Follow the pairing instructions by clicking on the **“Settings”** icon in top left of main screen. Please ensure **Bluetooth** is turned **ON** in your device.

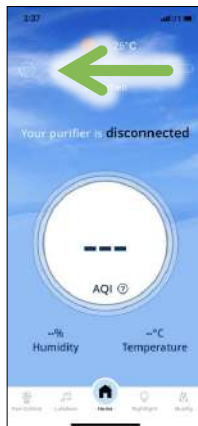

Click on **“Pair”** to begin the device pairing process.



4

Getting Started with Bebcare Air

Portable comfort fan + air purifier for your baby

5

Follow the step-by-step instructions in the app to finish pairing the Bebcare Air device. Please ensure your **Bluetooth is ON**.

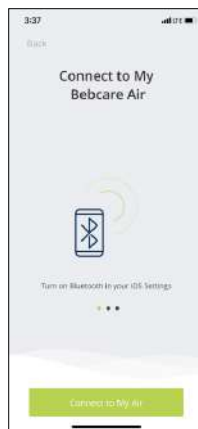

Once paired, the Air Quality Index (AQI) reading shows up. The value is calculated by the industrial grade sensor on the product. The lower the value, the better the air quality.



6

Getting Started with Bebcare Air

Portable comfort fan + air purifier for your baby

7

Features on the Bebcare Air

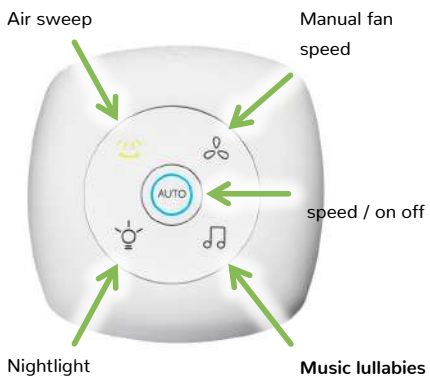

Comfort fan +
Clean air
outlet

Air quality
indicator +
Nightlight

8

Please contact hello@bebcare.com
if you have any questions using the Bebcare Air!