

# SHOWER DOOR INSTALLATION INSTRUCTIONS

## AC23

(All Models)

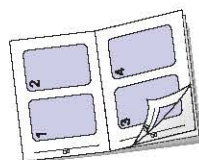
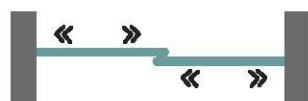

1-12

BP-05

Please read these instructions carefully before installing. If you have any questions regarding installation, please call our technical support specialists

**OUTSIDE VIEW:**

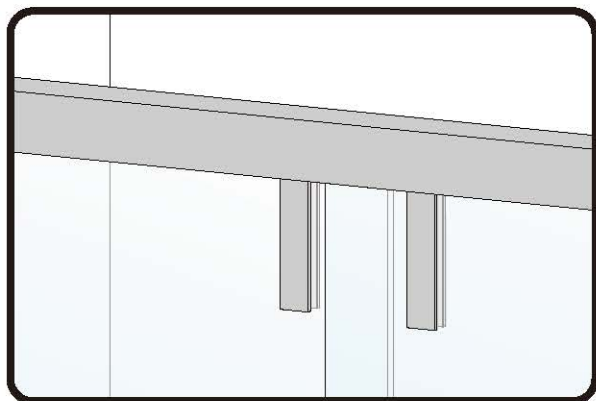

**INSIDE VIEW:**

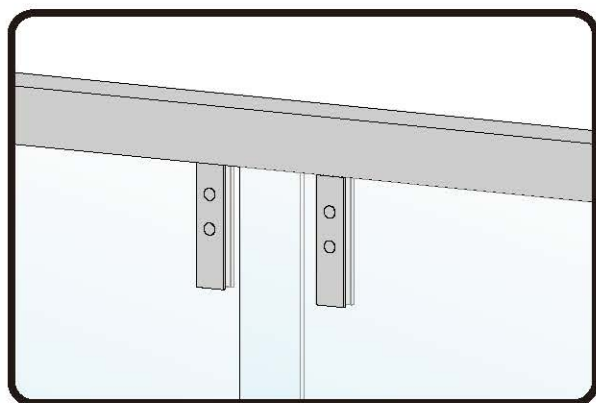

**Please read these instructions carefully before installing. If you have any questions regarding installation, please call our technical support specialists**

## • Installing Preparations

- After opening the carton, please read the instructions carefully, examine boxes and packages for shipping damage. If the unit has been damaged, has a finishing defect, or has missing parts, please contact our customer support department. Please note that we will not replace any damaged products or missing parts free of charge if the product has been installed. Feel free to contact us if you have any questions.
- Please note that you should consult your local building codes with questions on installation compliance standards. Building and plumbing codes may vary by location; we are not responsible for code compliance standards for your project and will not accept any returns.
- If this screen is going to be installed in a new construction, please, install all of the required plumbing and drainage before installing the shower. Use a competent and licensed (if required) plumber for all plumbing installation period.
- During installing, please make sure the installation surface is level and solid and will be able to support the total weight of the screen. Also, make sure that the walls are plumb. Depending on the type of screen you are installing, some adjustments in leveling may be possible. However, irregular installation, surface level or out of square conditions can result in serious problems for your installation. Please note that some adjustments and drilling may be necessary. Please protect all primary surfaces of the product during installation. Never set your glass down directly onto a tile floor. Always use a piece of wood or cardboard to protect the bottom edge and corners of the glass.
- Please wear below protect tools during installation.



- Following tools are necessary for installing the shower enclosure.

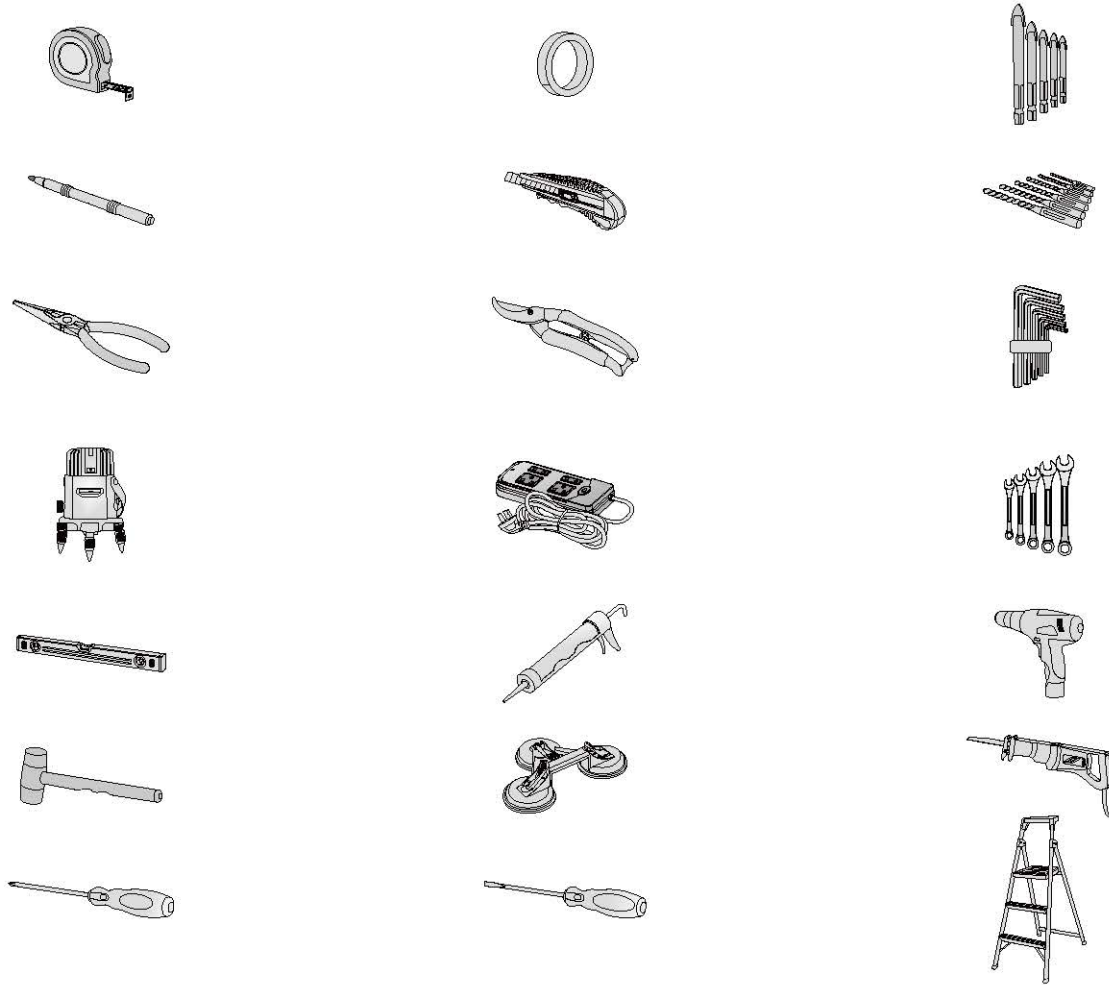

## ▪ WARM TIPS

- Open the packaging carefully and inspect all the necessary parts using detailed diagram and component list in your manual as a reference. Before discarding the carton, check for small hardware bags that tend to fall to the bottom of the box. If any parts are damaged or missing, please contact us for replacement.
- Retain these installation instructions for future use if in need.
- The meaning of mark



Be careful! Please don't scratch or damage parts during installation.



Import! Please install shower enclosure as per installation instructions.



Reference! Please install successfully as per the warm tips.



Up! Please make it be up!



Down! Please make it be down!









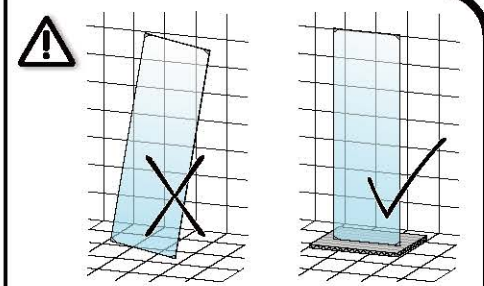
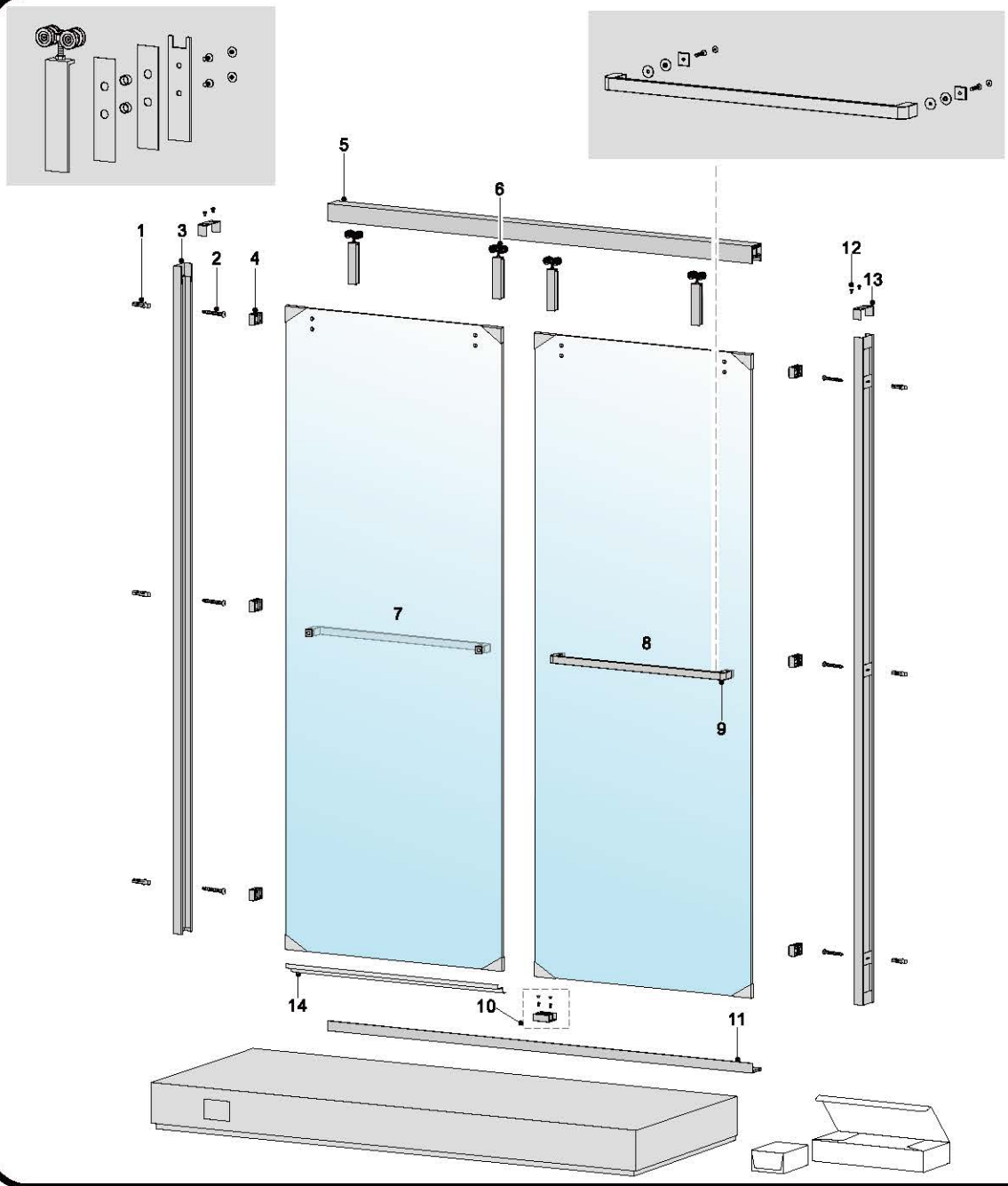







Inside! This symbol indicates that a place faces inside!



Outside! This symbol indicates that a place faces outside!



1	 X6	2	 X6	3	 X2	4	 X6
5	 X1	6	 X4	7	 X1	8	 X1
9	 X2	10	 X1	11	 X1	12	 X4
13	 X2	14	 X1				

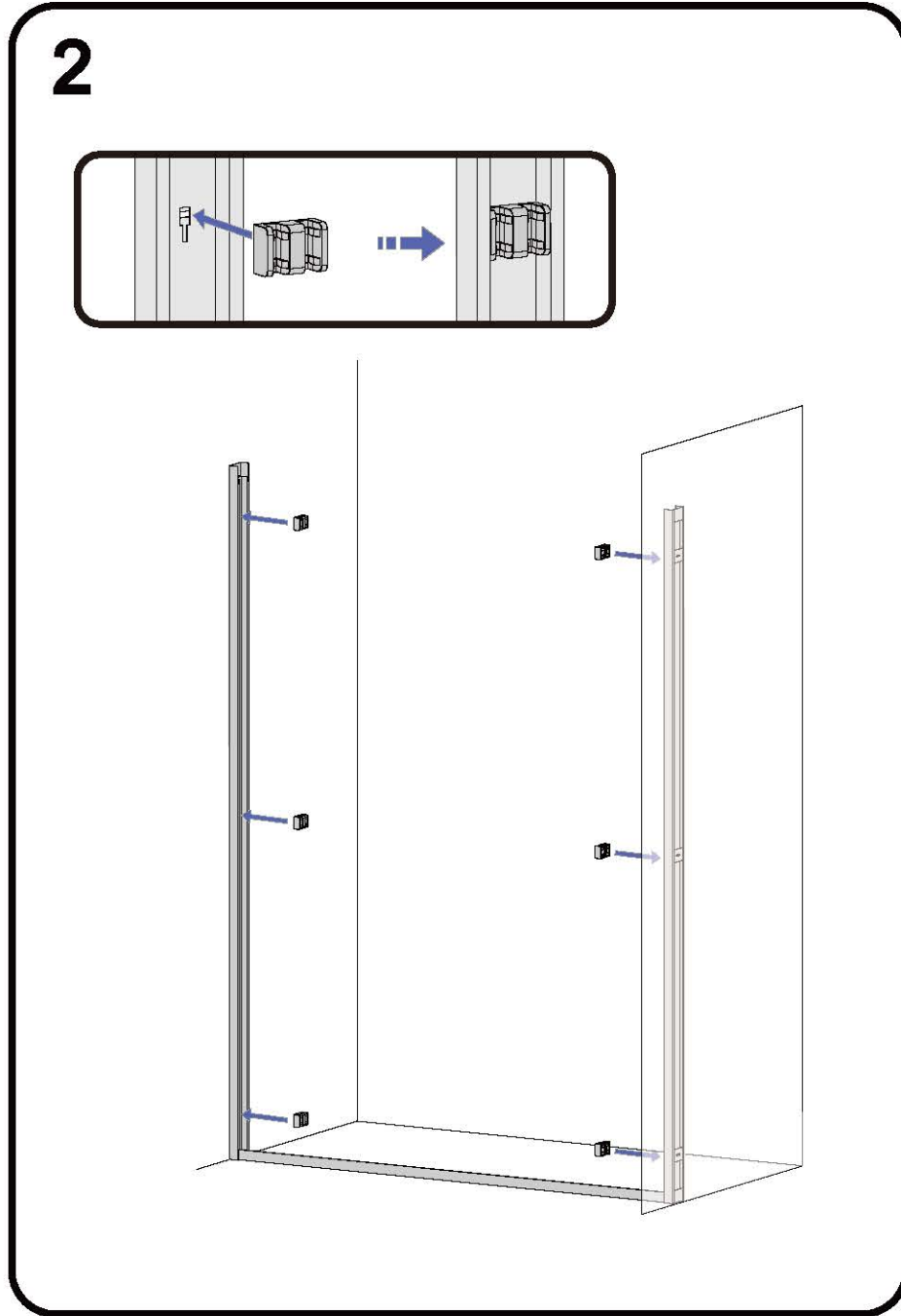
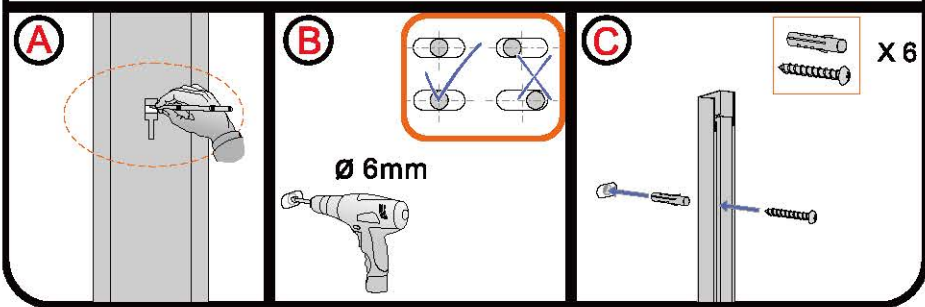

3

A

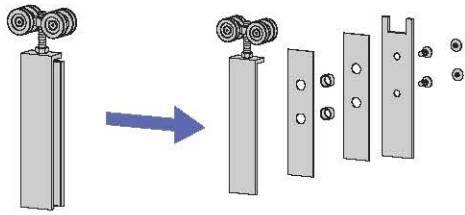

B

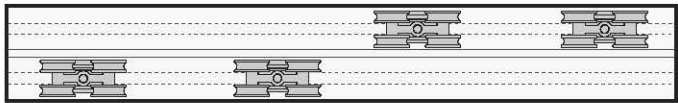
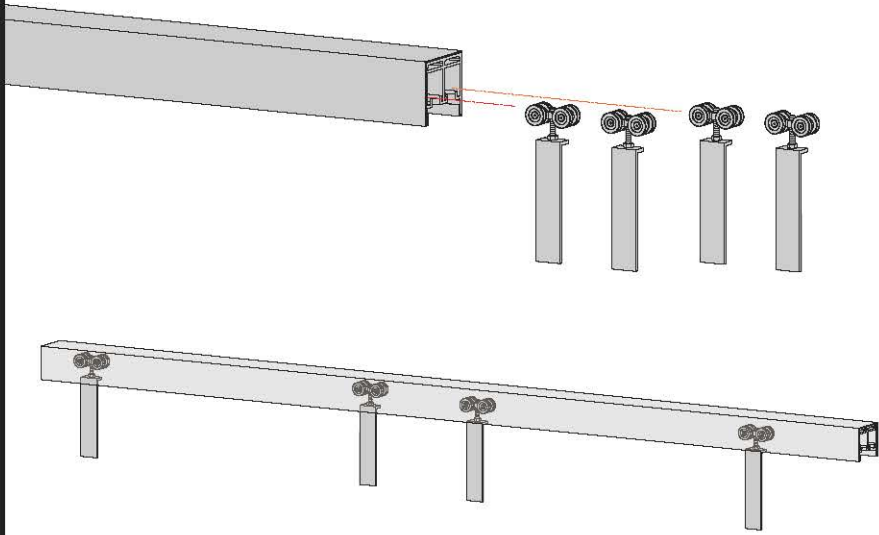

4

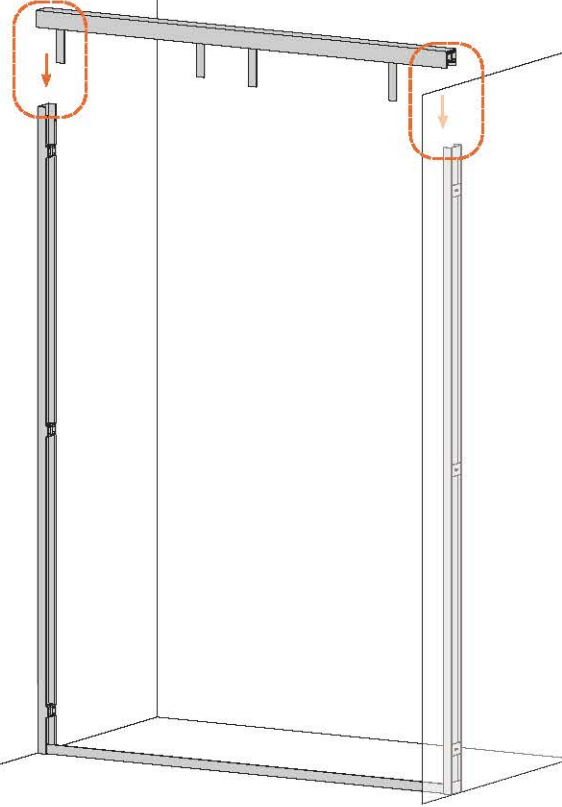
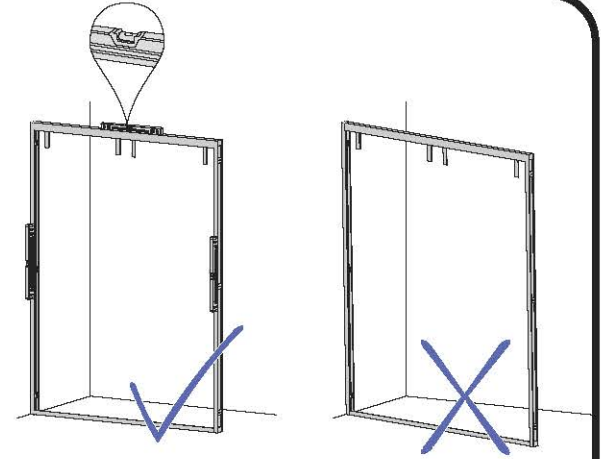



90

5

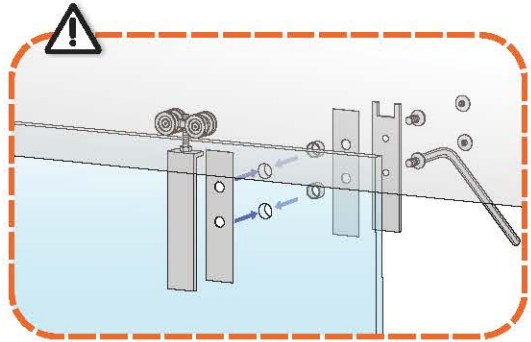

6

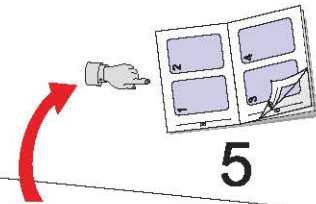



7



↩ Inside! This symbol indicates that a place faces inside!

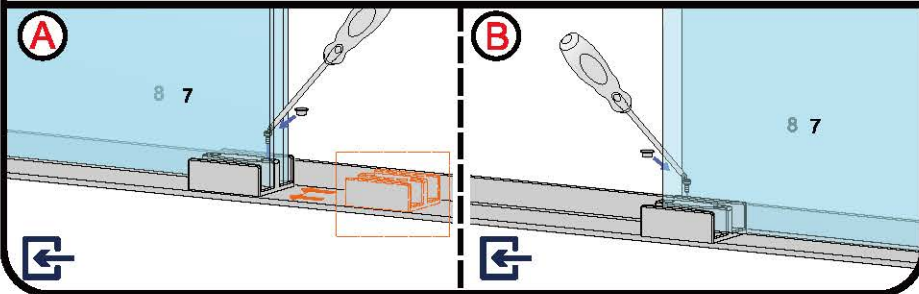

8

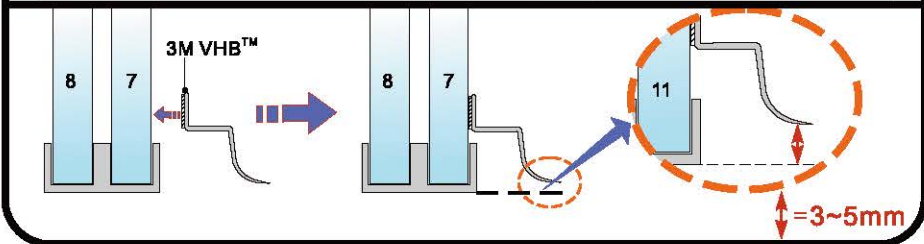
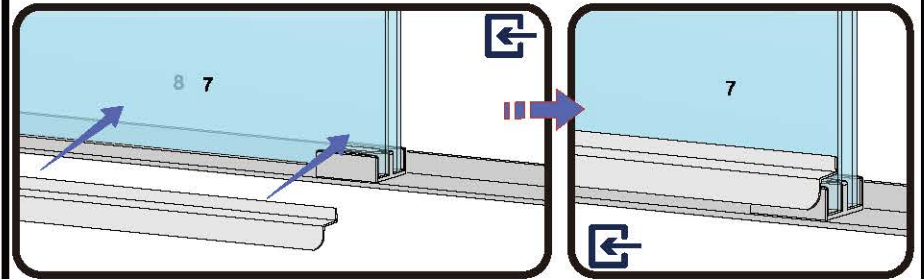

9

OVERHEAD VIEW:

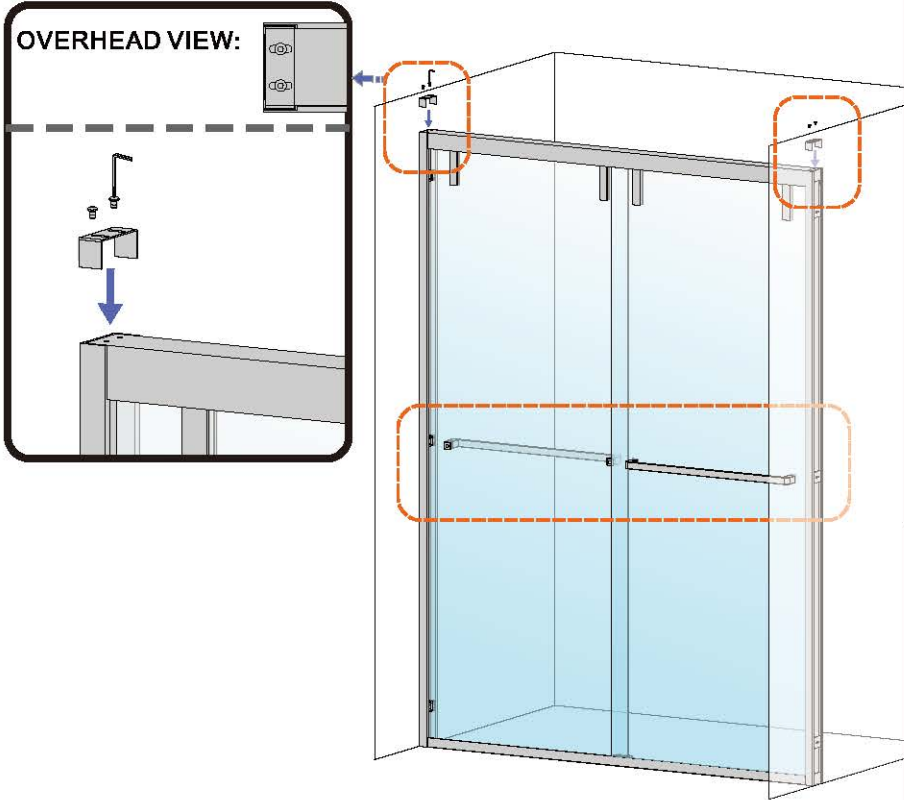

10

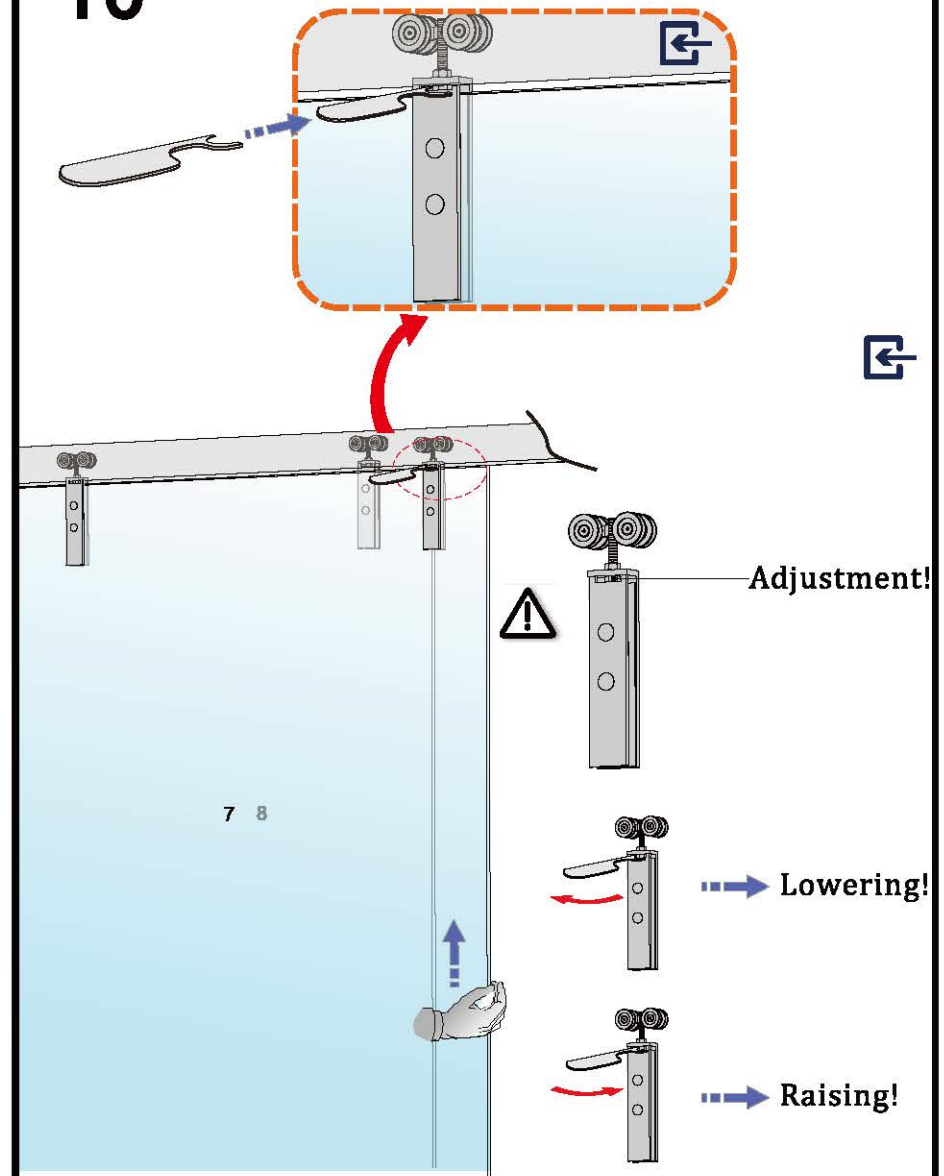

Inside! This symbol indicates that a place faces inside!

11

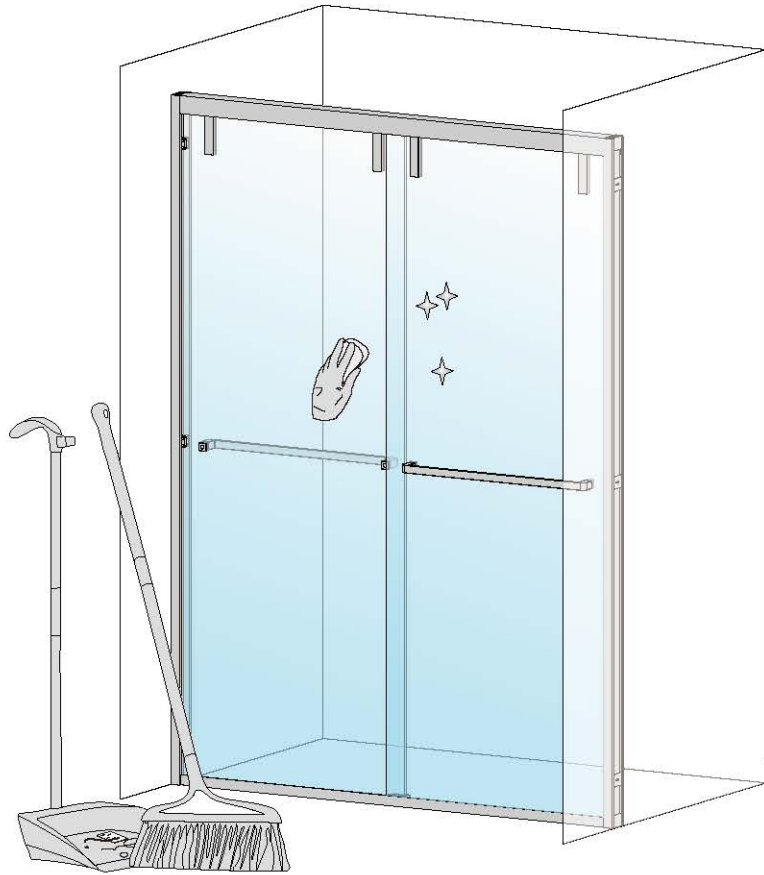

12

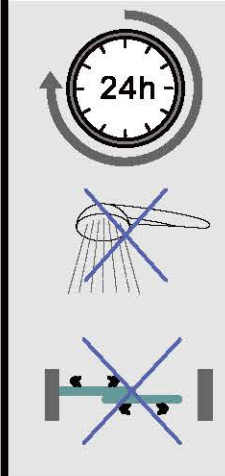

## ▪ **Clean up**

- After the installation is complete, please check the installation of the shower enclosure according to the product renderings, make sure the installation is correct, then clean the shower enclosure, clean the floor and the installation is over!

## ▪ **Sealing treatment**

- Apply sealant evenly around the walls and shower area, after 24 hours can be cleaned or used.

## ▪ **Product Maintenance**

- To ensure long lasting life for your shower door, please clean the dust or stains use non-abrasive sprays or cream based cleaners. Never use abrasive cleansers, metal brushes or scrapers that could scratch or dull the surface.
- To ensure a long lasting hardware finish, wipe off the metal parts after each use with a soft cloth. Do not use abrasive cleaners or cleaning products containing ammonia, bleach or acid. If accidentally used, rinse the surface as soon as possible to prevent finish peeling or corrosion. After cleaning the shiny finishes, rinse thoroughly and wipe dry with soft cloth. Clean stainless steel surfaces at least once a week. When applying stainless steel cleaner or polish, work with (not against/across) the grain. Never use an abrasive sponge or cloth, steel wool or wired brushes.
- Thank you for choosing our shower door.