

# PATIO COMFORT

OUTDOOR PATIO HEATER  
MODEL PC-02

## ASSEMBLY INSTRUCTIONS CARE, USE, AND SAFETY MANUAL

### FOR YOUR SAFETY!

Do not store or use gasoline or other flammable vapors or liquids in the vicinity of this or any other appliance.



**WARNING - California Proposition 65**  
The burning of gas cooking or heating fuels (and certain components contained in this product) generates some by products which are on a list of substances known by the state of California to cause cancer or reproductive harm. California law requires businesses to warn customers of potential exposure to such substances. To minimize exposure to such substances always operate this appliance in accordance with our Use & Care Guide in the (Owner's Manual) and ensure you provide good ventilation when cooking with gas. For detailed information please see the official California Prop 65 website at:  
[www.P65WARNINGS.CA.GOV](http://www.P65WARNINGS.CA.GOV)



### General Hazard Warning:

Improper installation, service, adjustment, alteration or maintenance of this product can cause injury or property damage. Please read the installation, operating, and maintenance instructions thoroughly prior to installing or servicing this appliance.

Please read all operating instructions before using and operating this appliance. Always follow the correct lighting and usage procedures.  
Please handle metal parts with care to avoid injury. Please follow all steps as outlined.  
Never allow children to use this product!

### **WARNING: FOR OUTDOOR USE ONLY**

**Please Note:** This product meets CSA International Requirement 5.90 US (5<sup>th</sup> edition) for Gas-Fired Infrared Patio Heaters and ANS Z83.26-2014 • CSA 2.37-2014 Gas Fired Port-able Infrared Heaters. Please use a Type 1 QCC ACME Tank Only with Overfill Protection Device (OPD) Maximum inlet pressure 11"

Revised 04/12/2018

## **WARNING: FOR OUTDOOR USE ONLY!!!**



**SPECIAL ATTENTION:** THIS SYMBOL NOTES SAFETY RELATED ITEMS OR PRODUCT WARNINGS

**Caution: Hot while in operation. Do not touch. Keep children, clothing, furniture, gasoline and other liquids having flammable vapors away from heater at all times.**

1. The installation of this appliance must conform with local codes or, in the absence of local codes, the National Fuel Gas Code ANSI Z223.1-1988.
2. There must be adequate clearance around all air openings into the combustion chamber, clearances from combustible materials, and accessibility and for combustion and ventilating air supply. See page 16 for specific clearances from combustibles.
3. The inlet gas supply pressure must be 11" W.C. Use only the hose, regulator, and tank adapter that are supplied with the product. For use with LP Gas only.
4. Test all fittings and connections with a soapy solution prior to use. Never use an open flame or open flame device.
5. Certain items or materials when stored under the heater or too close to the heater head will be subject to radiant heat and these items could be damaged.
6. Please review carefully and follow all assembly instructions as shown in this manual.
7. If you do not understand any of these instructions please call your selling dealer or call us directly at 949-474-3070 or email us at [info@aeicorporation.com](mailto:info@aeicorporation.com) .
8. Please carefully inspect the unit before each use. Be sure there are no visible cracks, damage, abrasion, or other signs of visible wear. If the hose appears to have any problem whatsoever it should be replaced with a genuine Patio Comfort replacement part.
9. If you experience any problems or have any questions please contact your selling dealer or AEI Corporation directly. Please do not return the unit to the seller without prior authorization.



**Please make note of all CAUTIONS, WARNINGS, INSTRUCTIONS and INFORMATION throughout this guide.**

## **Please note the following very important safety precautions:**

 Children and adults should be alerted to the hazards of high surface temperatures of the main burner and reflector and should stay away from these areas.

 Children should be carefully supervised when near the heater. This heater is not a toy and children should not be allowed to push, climb on, or swing on the heater, this could cause serious injury, property damage, or death.

 Clothing or other flammable materials should not be hung from the heater or placed near the heater while in operation.

 Installation and repair of the heater should be done by a qualified service person. The heater should be visually inspected before each use and at least annually by a qualified service person. Certain weather conditions such as being near the ocean, dusty areas, areas with high humidity, areas with high wind conditions, and heavy use, may require more frequent cleaning or maintenance. When in doubt call a qualified service person. It is imperative that the control compartment, burner system, and circulating air passages of the heater be kept clean.

 Any part or component removed for cleaning or maintenance must be properly re-installed or replaced with a Patio Comfort OEM replacement before using the heater.

## **Some basic maintenance instructions:**

The heater post and base may be cleaned with basic soap and water and mild household cleaning products, car wax, or commercially available stainless steel cleaners.

Never attempt to clean the emitter grid with cleaning solutions. Never spray the heater head with water. The heater head should be cleared using compressed air only. These parts are constructed of commercial quality stainless steel and brass and under normal use will require no other maintenance.

 The heater head should be cleared of soot and debris annually or if the flame characteristics change. Use only compressed air for this maintenance. Any part or component removed for cleaning or maintenance must be properly re-installed before using the heater.

 Be sure to keep the area where the appliance is being used free from combustible materials, gasoline, and other flammable materials.



Please be sure there are no obstructions near the heater head. Please be sure there is no debris or other obstructions near the propane cylinder enclosure.

The appliance is operating properly when there is a nice cherry red glow (seen better at night) coming from the emitter grid starting within two to three inches from the bottom of the emitter grid. Wind gusts will affect this glow and the flame pattern. The heater should not be operated in wind exceeding 10mph. If you can protect the heater from wind gusts it will operate far more efficiently.

Operating the unit in severe wind or dusty conditions will affect the burning characteristics, may create soot on the emitter grid and burner, and possibly clog the pilot or main burner orifices. Occasionally, you can gently brush the emitter grid with a small brush to remove excess soot that may have accumulated on the emitter. If the burner, emitter grid or reflector show sooting you may have to remove the emitter grid and clear the burner head with compressed air. See page 19 of the manual for added information.

## **Some basic information on propane:**



**Only use an ACME Type 1 equipped Five Gallon Propane Cylinder with approved overfill protection device or “OPD.”**

1. Your Patio Comfort heater has been carefully designed to provide many years of service. Please do not try to convert your heater to another fuel type or to accept any other type size cylinder, hose, or regulator.
2. Only cylinders that are constructed to meet the U.S. Department of Transportation (DOT) requirements should be used with the heater.
3. It is absolutely imperative that this heater only be used OUTDOORS and in a well-ventilated space and shall not be used in a building, garage, motor vehicle, boat, tent, or other enclosed areas. This is an unvented heating product and creates byproducts of combustion that can cause injury and possibly death.

4. The propane cylinder should be connected and disconnected with the main fuel valve in the off position. This can be achieved by turning the triangular handle on top of the cylinder in a clock-wise direction. The black acme hand wheel must be tightened securely for the gas to flow from the cylinder. You do not need any tools to make the proper connection from the LP adapter to the tank. Do NOT over-tighten the hand wheel or you may damage it. For complete instructions in this area a please refer to manual pages 15 and 16.
5. The cylinder should be disconnected from the heater when not in use.
6. **Propane cylinders can only be stored outdoors. Never store a cylinder in any enclosed area.** For complete storage instructions refer to page 18 of this manual.
7. Only the hose, regulator, and LP Adapter designed for an OPD cylinder supplied with appliance can be used. If you require a replacement these can be easily obtained from your Authorized Patio Comfort dealer. An improper hose and regulator may compromise the performance and safety of your heater.

The preceding pages attempt to highlight only the most important safety aspects and guide lines for using your Patio Comfort heater. We have made every effort to thoroughly address all safety, assembly, lighting, propane storage, and use issues for this product in the manual to follow. We strongly encourage that you read and understand the materials contained in the manual before using your heater. If you have any questions whatsoever regarding the safe assembly or use of your heater please call your patio Comfort Dealer or call us directly at 949-474-3070 (7 a.m. to 4 p.m. Monday-Friday PST) or email us at; [info@aeicorporation.com](mailto:info@aeicorporation.com) .

**Thank you** very much for purchasing a *Patio Comfort* Patio heater. This manual contains very important information detailing the proper assembly, operation, and maintenance of this product. This product has been designed with the latest in safety technology but it is important to remember that this is a heating appliance and some of the surfaces are extremely hot to the touch and can cause bodily injury.

Important safety information is presented throughout this manual for your safety and that of your family. We have designed this product to provide you with many years of outdoor comfort when operated and maintained properly.

## Table of Contents

<b>Basic Safety and Operational Data.....</b>	<b>1-5</b>
<b>Technical Data, Function of Heater, Assembly Tips .....</b>	<b>7</b>
<b>Parts Diagram and Part Descriptions (Heater Head).....</b>	<b>8</b>
<b>Parts Diagram (Base and Support).....</b>	<b>9</b>
<b>Assembly Instructions .....</b>	<b>10-15</b>
<b>Preparation for Use and Cylinder Information.....</b>	<b>15, 16</b>
<b>Placement of the Heater &amp; Clearances Required .....</b>	<b>16</b>
<b>Proper Lighting Instructions.....</b>	<b>17</b>
<b>Storing Your Heater &amp; Insect Warning.....</b>	<b>18</b>
<b>Cleaning and Maintenance.....</b>	<b>19</b>
<b>Trouble Shooting Guide.....</b>	<b>20</b>
<b>Detailed Warning and Safety Points.....</b>	<b>21, 22</b>
<b>Some Important Safety Tips on Propane and the safe use of.....</b>	<b>23</b>
<b>Warranty &amp; Service Information .....</b>	<b>24, 25</b>
<b>NOTES:.....</b>	<b>26</b>
<b>Warranty Registration Form .....</b>	<b>27</b>

# Technical Data

**Fuel:** LPG (Propane) Only

**Heating:** Each *Patio Comfort* heater will cast a 10-12 foot circle of sun like radiant heat. Heat output will vary based on “wind chill” factor, outside air temperatures, humidity, altitude, prevailing wind conditions, and location of heater.

**Gas Cylinder:** A Type 1 “ACME” QCC with Overfill Protection Device (OPD) Cylinder is required but not included. All new cylinders are empty and should be filled by an authorized fueling station or cylinder exchange facility.

**Pressure:** The unit is equipped with an LPG Regulator Preset to 11.0 Inches Water Column. This specially designed regulator must be used with this appliance. Maximum supply inlet pressure 100 psi. Minimum inlet supply pressure 5 psi.

**Fuel Consumption:** 40,000 BTU Input /Hour Cylinder will operate unit for approximately 9 - 10 hours on “ON” setting.

**Orifice Size:** 1.90 mm

**Weight:** 64 pounds or 29 Kilograms not including cylinder

**Overall Height:** 90 inches 228 cm

**Reflector Diameter:** 34 inches or 86 cm

**Ignition System:** Push Button Piezo with Pilot Flame

**Fasteners:** 304 Series Commercial Grade Stainless Steel

**Materials:** Reflector: 1 Piece Anodized Aluminum

**Heaters:** Major Components: Series 304 Stainless Painted Heaters: Cold Roll Steel with mechanically bonded Polyurethane UV powder coating. Emitter 430 SS

**Other features:** 100% Safety Shut Off Valve

No Electrical Connections Required

Constant Pilot

Completely Self- Contained

Portable Wheel Kit Included

## Function of Heater

Infrared heaters utilize virtually 100% of the fuel/energy they consume to produce clean draft-free warmth. Infrared heaters do not waste precious energy by trying to heat the air. Infrared heat works like the radiant rays of the sun and will directly heat objects near them such as people, tables, chairs who in turn will absorb the heat and reflect it. The push button Piezo ignition system is used to light the

pilot flame first.

After the thermocouple device allows gas to flow to the main burner head you may then safely engage the main burner system by turning valve control knob to “ON” Setting.

After the main burner is lit the burner will radiate heat in a 360-degree circle. The circle of warmth will vary dependent on outdoor temperatures, wind chill factor, area protection, and other variables. The average heating area is approximately a 10-foot ring of warmth. The reflector will return upwardly radiated heat downwards. Please allow heater to burn a few minutes to burn off machining oils used in the production of the heater.

**Please note:** *Upon first using the heater, not using the heater for an extended period, or after attaching a newly filled cylinder it might be necessary to depress the control knob at the “PILOT” setting up to two to three minutes to purge the air in the fuel lines before the PILOT flame will ignite. Please be patient, this is all part of the safety system that has been designed for your protection.*

## Assembly Tips

For your convenience and safety, the *Patio Comfort* outdoor patio heater has been almost completely assembled. The burner head and valve assembly have been fire tested for added safety.

Assemble all nuts and bolts loosely at first. Tighten all connections after the completion of the assembly process. This eases your work and increases the overall stability of the appliance. Before using the heater be sure to check all connections with a solution of soap and water.



**Never use a flame to check for leaks!**

When starting the assembly please take all of the parts out of the box and check if anything is missing. Please check parts with the following parts breakdown. Even though we exercise extreme quality control procedures occasionally we will have a missing part or a part may have been damaged in transit. If anything is missing, please contact your *Patio Comfort* dealer or call us directly at 949-474-3070 (M-F 7 a.m.-4 p.m. PST). The same holds true on any questions you might have on assembly or

operation. When in doubt please ask, we're at your service.



# Patio Comfort Outdoor Patio Heater Model PC-02

## Parts Diagram and Repair Parts

For Heater Heads Model PC-02 (AB, J/SV, S, and W finishes)

KEY#	PART#	DESCRIPTION	QTY
1	1001	Hex-Nut M8 S/S	3
	1001-03	Wing-Nut M8 S/S	3
2	1002	Flat Washer 8mm dia. S/S	6
3	1003	Reflector (PCR)	1
4	1004	Lock washer 8mm dia. S/S	3
5	1005	Hex-Bolt M8 x 20mm S/S	3
6	1006	Emitter Grid	1
7	1007	Burner Assy with shield	1
8	1008	Screw for Pilot shield M4x8mm S/S	2
9	1009	Screw for Burner Retention M4x6mm S/S	2
10	1010-07	Base Fitting for Orifice / main Burner	1
11	1011	Pan Head Screw M5 x 8 mm S/S	17
12	1012	Pan Assy S/S	1
13	1013	Perforated Body	1
14	1014	Pilot Shield	1
15	1015	Electrode, wire and sleeve	1
16	1016	Pilot Body only (no orifice) see 36	1
17	1017	Wire Insulation sleeve only	1
18	1018	Thermocouple with nuts	1
19	1019	Pilot Tube Assy (no orifice) see 36	1
20	1020-07	Orifice for LP main burner	1
22	1022-07	Tube Assy for burner	1
23	1023	Thermoelectric control valve	1
24	1024-15	Male 3/8 Extension Fitting at valve base	1
25	1025	Bracket for valve mounting	1
26	1026	Bracket for base fitting #24	1
27	1027	Base for heater head	1
28	1028	Flat washer 6 mm dia. S/S	4
29	1029	Lock washer 6 mm dia. S/S	4
30	1030	Faceplate for Lighting instruction LP	1
31	1031-11	Knob w/set screw	1
32	1032	Specific Nut for Valve	1
33	1033	Piezo Igniter button	1
34	1034	Pan head Screw M6 x 12mm s/s	4
35	1035	Specific PAL Nut for Igniter	1
36	1036	Pilot Orifice for LP	1
37	1037	Self-tapping Pan Head Screw M5x12 S/S	4
38	1038	Pan head Screw M4 x 6mm s/s	3

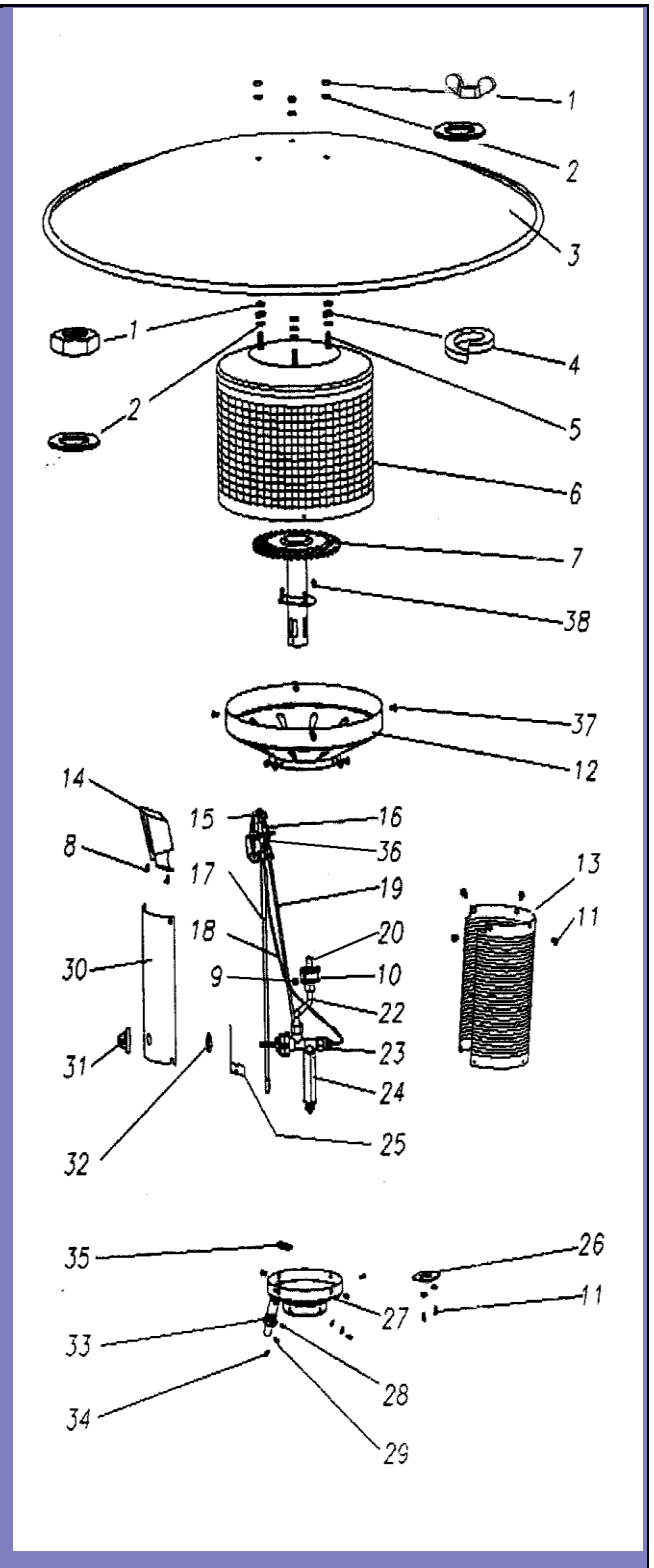

# Patio Comfort Outdoor Patio Heater Model PC-02

## Parts Diagram and Repair Parts

*For Heater Heads Model PC-02 (AB, J/SV, S, and W finishes)*

KEY#	PART#	DESCRIPTION	QTY
*1	4101	Post 3"x36" S/S	1
1	3101	Post 3"x36" White, J/SV, AB	1
2	1102-15	3/8" Hose Only (Begin 2015)	1
*3	4103	Slip Socket Cover S/S	1
3	3103	Slip Socket Cover White, J/SV, AB	1
4	1104-04	Hex-Bolt M6 x 20mm S/S	6
5	1105	Flat Washer 6mm dia. S/S	32
*6	4106	Socket Assy for S/S	1
6	3106	Socket Assy for White, J/SV, AB	1
*7	4107	"L" Bracket for S/S	3
7	3107	"L" Bracket for White, J/SV, AB	3
8	1108	Lock Washer 6mm dia. S/S	26
9	1109	Hex-Nut M6 S/S	18
10	1110	Chain Assy for tank restraint	1
11	1111-09	Hex-Bolt M6 x 55mm S/S Ballast	8
*12	4112	Base S/S	1
12	3112	Painted Base White, J/SV, AB	1
13	1113-09	Ballast Weight for all LP Bases	1
14	1114-15	LP Regulator & QCC Only (Begin 2015)	1
16	1116	Molding for Decorative Socket	1
*18	4118	Decorative Cover S/S	1
18	3118	Decorative Cover White, J/SV, AB	1
*19	4119	Wheel Assy w/Bracket (1ea.)S/S	2
19	3119	Wheel Assy (1ea.) White, J/SV, AB	2
20	1028	Flat Washer 6mm S/S	4
21	1034	Head Screw M6 x 12mm S/S	4
23	1123	Molding for Base Bottom	1

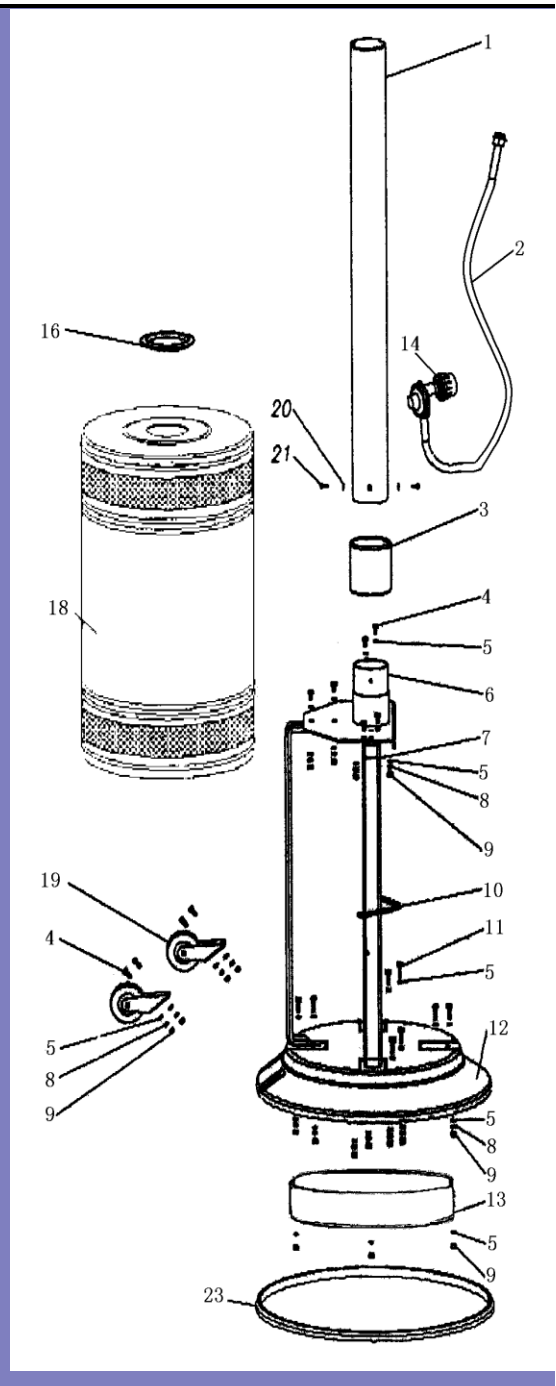

**Please specify color when ordering replacement painted parts (#1,3,6,7,12,18 and 19)**  
**AB = Antique Bronze    W = White    J/SV = Jet Silver Vein**  
**S = Stainless Steel    All painted and stainless parts are interchangeable.**

**You will need the following tools to assemble the heater:**

10MM Socket for Brackets and Wheel Kit  
11MM or 7/16" Socket for Ballast Plate Securing Nuts  
12 MM Socket for Reflector Attachment Nuts

Standard Phillips Head #2 or #3 Screw Driver  
Channel Locks or Pliers-Minimum 1 1/2" Capacity  
Adjustable Crescent Wrench or Socket Driver  
Soapy Water Solution for leak testing

**Do Not Use any Teflon tape or other sealants when connecting heater head to hose or hose to regulator. These are "Flare to Flare" connections and will seal without the need for Teflon tape or pipe dope. The use of tape or compounds may compromise the seal.**

**Fastener Identification**

**Posts**

8 – Pan Head Screws M6x12 mm S/S  
8 – Flat Washers 6mm dia.  
4 – Lock Washers 6 mm dia.

**Wheel Kit:**

Hex Bolt M6x20 mm S/S  
Hex Nut M6 S/S  
Flat Washer 6mm dia. S/S  
Lock Washer 6 dia. S/S

**PLEASE NOTE:** The proper assembly of this heater requires basic mechanical skills. Proper assembly is the responsibility of the installer. Any and all repairs or service should be done by a qualified gas appliance technician.

**Assembly Instructions**

The majority of your *Patio Comfort* Outdoor Patio Heater product is already assembled, tested, and pre-fired for your safety and convenience. We have shipped the heater head inside the pre-assembled lower base to protect the heater head in shipment and to simplify assembly.

1. Open the carton and remove the top packing, the decorative tank cover and parts boxes.
2. Lay the carton on its side to more easily pull the unit out and stand it upright. Fig #1 and 2.
3. Lift up the foam pad and remove it over the tank cage.
4. Remove the head carton from the tank cage and set it aside for now.



Laying the unit down on its side makes it a one person operation to take it from the box.

Fig #1



Heater head comes packaged and protected inside the tank cage. remove the head and pull the foam piece up and off.

Fig #2

5. Tilt and rest the lower base assembly (lean it on the carton) and attach the wheels to the base using the 10mm bolts nuts and washers provided on the wheels. Secure these tight. Fig #3  
Check and tighten all the 10mm bolts on the base at this time.
6. Locate and sort the hardware for the Reflector, Post to Socket and Post to head. NOTE: Lock washers will go on the post to head connection. Fig #4.

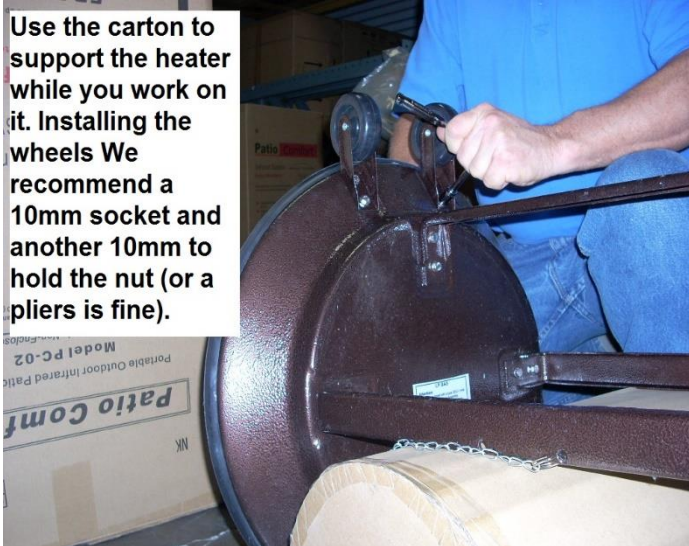

Use the carton to support the heater while you work on it. Installing the wheels We recommend a 10mm socket and another 10mm to hold the nut (or a pliers is fine).

Fig #3

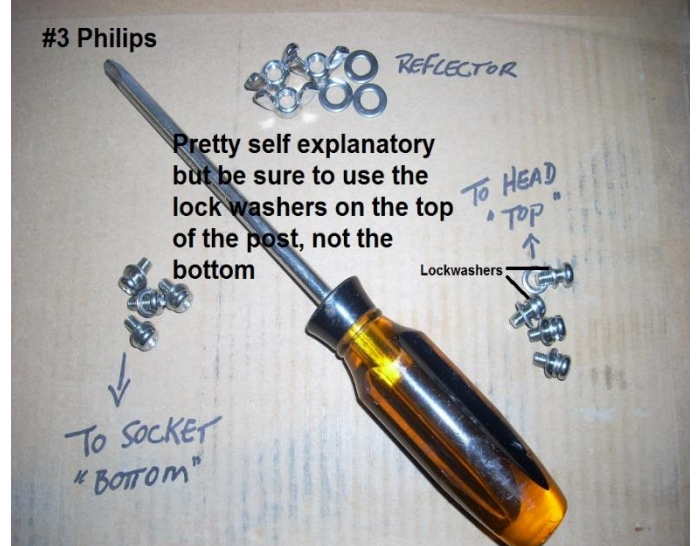
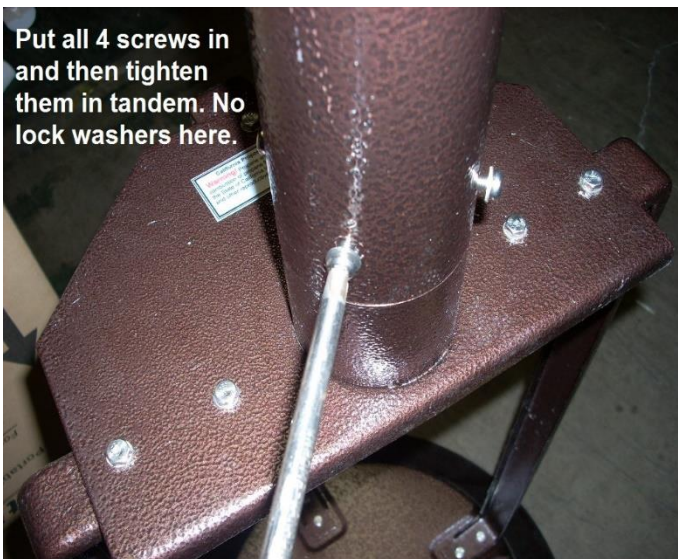

Fig #4

7. Return unit to upright and slide the bottom of the post over the socket assembly. Align the holes in the post to the holes in the socket assembly. Fig #5
8. Attach the post to the socket using 4 of the 6mm screws and FLAT WASHERS only. Align and start all 4 screws and tighten securely with #3 Philips. Fig #5
9. Slide the decorative cover, and the slip collar in place over the post as in Fig #6.  
**You need these 2 pieces in place before you attach the heater head.**



Put all 4 screws in and then tighten them in tandem. No lock washers here.

Fig #5



Lower assembly looks good so we are ready to attach the hose and the heater head.

Fig #6

10. Return the unit to leaning on the carton as before. Slide the decorative cover up (move the carton as necessary), to access the tank cage area. Fig #7
11. Feed the hose end of the hose and regulator assembly up through the hole in the post socket assembly Fig #8 until it appears from the top of the post.



Slide the decorative cover up to access the tank cage area.

Fig #7

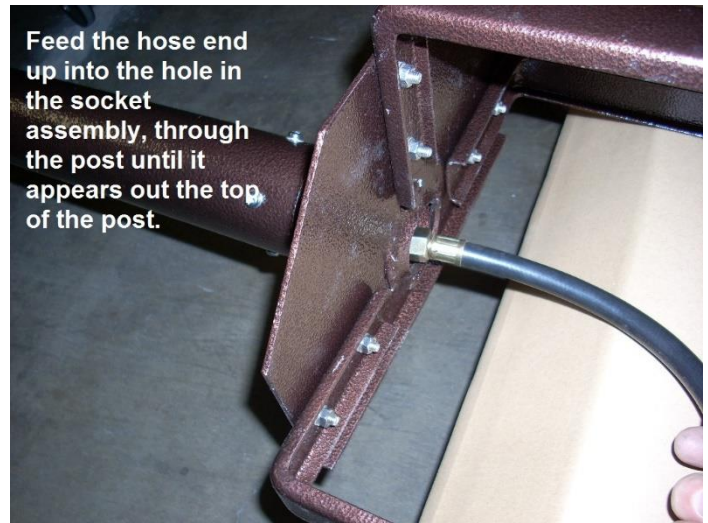

Feed the hose end up into the hole in the socket assembly, through the post until it appears out the top of the post.

Fig #8

12. Open the head carton and inspect it for any signs of visible damage.
13. When attaching the hose to the heater head start the thread carefully to avoid cross-threading and attach the 3/8 female swivel flare hose end fitting to the male flare fitting at the bottom of the heater head. Fig #9.
14. Check and tighten the factory connection at the hose to regulator also at this time. Fig #10  
**IMPORTANT: DO NOT USE PIPE TAPE OR COMPOUND AT THIS CONNECTION or CONNECTION OF THE HOSE TO THE REGULATOR BELOW.**  
**This is a FLARE to FLARE seal and use of any compound could compromise it.**

**IMPORTANT: DO NOT OVERTIGHTEN.** Brass and bronze are soft metals. Use 2 wrenches or pliers and MEDIUM torque please to firmly 'SNUG' this connection. Fig #9, 10



Use two wrenches to make this connection snug but do not over-tighten. Medium torque is fine.

Do this at the other end of the hose also just to be sure and you are ready for the leak test.

Fig #9



Good at the bottom? Ready to test!

Fig #10



## **LEAK TEST: IMPORTANT NEVER CHECK FOR LEAKS WITH A MATCH**

When confident that your connections are 'SNUG' you can begin the leak test to check your work. Fig #11, 12.

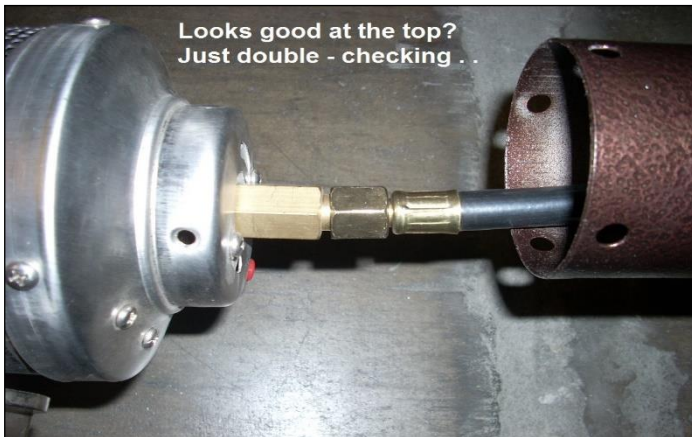

Fig #11

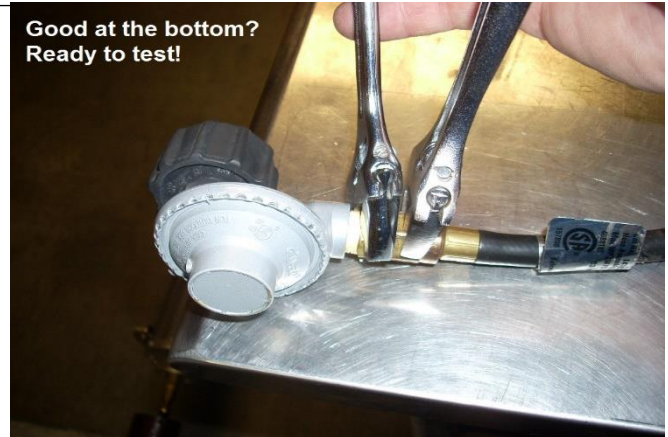

Fig #12

Prepare a small amount of soapy solution (mix 70% water with 30% foaming dish soap) in a spray bottle or cup. You can spray or paint it on with a brush applicator as well. You can perform this test while the heater is in the horizontal position. We will NOT be fire-testing in this position but the leak test is best this way.

15. Turn the control knob on the heater head to the "OFF" position.
16. Attach the LP regulator to a FULL and approved 20 lb. DOT LP GAS cylinder by turning the black hand-wheel on the LP Regulator clockwise onto the threads on the gas cylinder valve. Verify this connection is 'SNUG'. This is a hand-wheel and does not need tools to tighten. Fig #13



## **WARNING: IF YOU HEAR OR SMELL GAS FROM HERE ON THEN IMMEDIATELY TURN THE TANK VALVE OFF, CLOCKWISE. THEN: FIND AND CORRECT THE LEAK BEFORE CONTINUING.**

17. Turn the Tank valve counter-clockwise to charge the regulator and hose assembly. NOTE: You may hear a sigh when you open the valve and then it should be quiet. If you hear a leak, hissing sound, turn the tank valve off and check that the connections you made are tight before trying again.
18. Paint or spray the soapy solution liberally onto all connections from the black hand-wheel to the heater head. Quiet bubbles are expected but bubbles forming or moving are suspect. Fig #14, 15, 16.



Fig #13

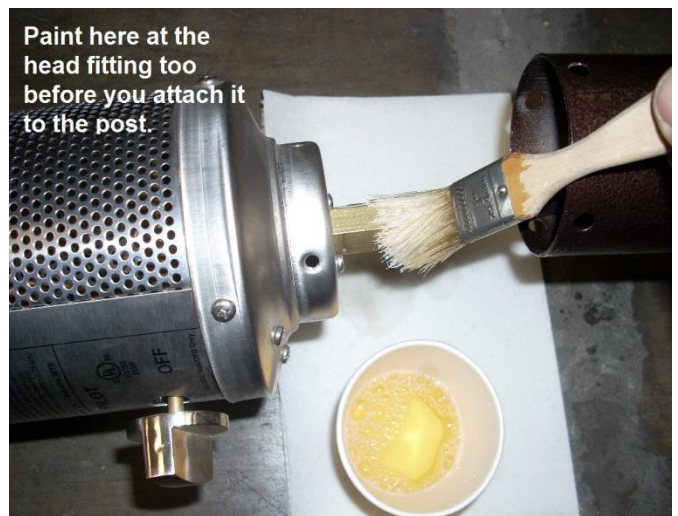

Fig #14



Fig #15 (Bad Bubbles)



Fig #16

19. Paint or spray all the connections thoroughly with the soapy solution. Bubble indicate a leak and any leaks need to be corrected before re-testing. Continue only when there are no bubbles forming.
20. Turn the tank valve off and disconnect the tank from the heater during final assembly. Set the tank aside for now.

**PLEASE NOTE:** If you have a newer style propane cylinder and it senses a leak in the fuel delivery system it may automatically reduce the flow of fuel to the appliance. Your tank is doing exactly what it's designed to do and that is to reduce the flow of gas if it senses a leak in the system. This is done for your protection. Again, check for leaks with a soapy solution if this occurs. If your safety system activates turn cylinder valve off, repair any leak and wait five minutes for the safety system to reset.

**NOTE:** If you do not properly tighten and engage the hand wheel and connection device at the regulator assembly it will NOT allow any gas to flow from the tank to the appliance. Be sure you have a 100% safe connection. DO NOT use tools to tighten regulator hand wheel to tank valve.

## FINAL ASSEMBLY:

21. With the tank valve closed and the tank removed from the heater, lower the decorative cover to the base of the heater and position the post collar as in Fig #17.
22. Lower the base of the heater head into the top of the post and hold it in place while carefully raising the unit upright. Attaching the head works best when upright.
23. Attach the heater head to the top of the post using 4 of the 6mm screws, flat washers and locking washers. The FLAT washers go up against the post.  
TIP: Start all 4 of the screws and then tighten them in tandem.



Fig #17

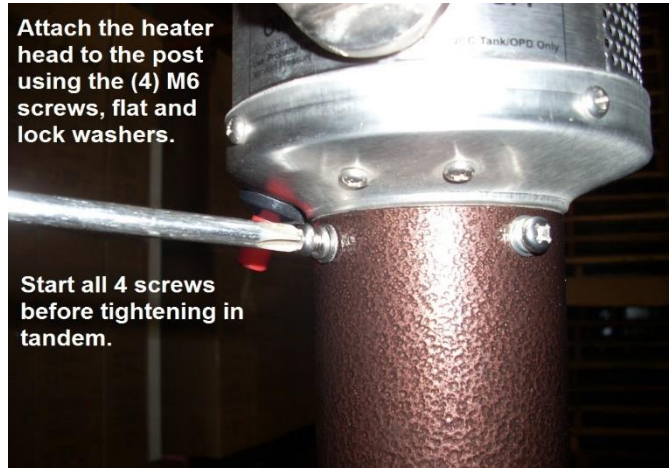

Fig #18

24. Lean the heater one last time and attach the reflector top using the (3) 8mm wing nuts and flat washers. Fig #19 and return the heater to upright.

25. To install the LP tank first return the unit upright and lift the decorative tank cover and rest it onto the socket assembly. Fig #20. Place the tank within the cage and secure with the tank retaining chain.

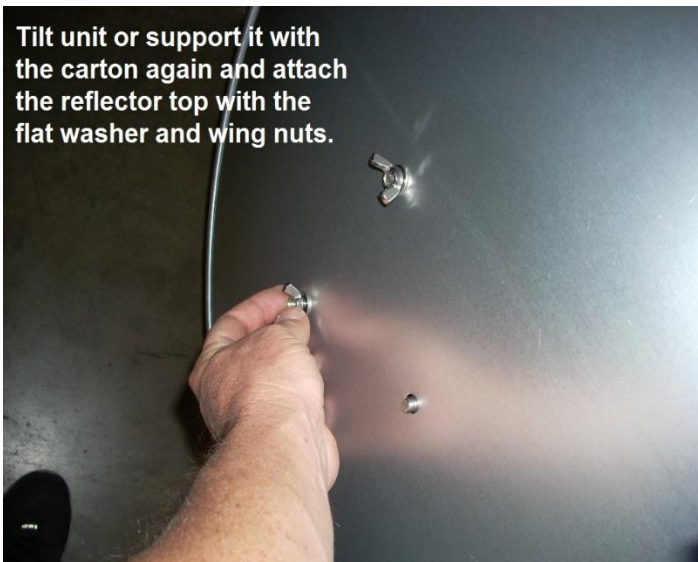

Fig #19



Fig #20

26. Reattach the LP tank to the heater (refer leak test step 13 – 15) and keep the cylinder valve closed until you are ready to fire-test the unit.



**IMPORTANT: KEEP CYLINDER VALVE CLOSED WHEN NOT IN USE AND REMOVE THE CYLINDER WHEN HEATER WILL BE DORMANT OR WHEN YOU ARE STORING FOR A LENGTH OF TIME. LP CYLINDERS SHOULD ALWAYS BE STORED OUTDOORS IN A WELL-VENTILATED AREA.**

## Preparation for use

You will need to purchase a 20-pound TYPE I QCC/ACME propane cylinder equipped with an Overfill Protection Device. Your **Patio Comfort** dealer or distributor can provide you with this safety cylinder. We highly recommend you purchase a new 20 lb. OPD cylinder manufactured by either Worthington Cylinder or Manchester Tank Company. Both are U.S. producers of highly quality propane cylinders.



**Please do not try to use any other propane cylinders with this appliance. Please do not attempt to modify our hose assembly, regulator, valve, ignition system or other components. These high quality components have been integrated in your heater to provide you with maximum safety, performance, and reliability.**

## Installation and Replacing of your LP GAS Cylinder

After purchasing and filling a propane cylinder you will be ready to install it into your patio Comfort heating appliance. Important information regarding your propane cylinder is also found on pages 4 and 5, the leak test section as well as several significant statements throughout this manual.

Each time you change the tank is an excellent time to inspect the hose for any excessive wear or possible abrasion that could cause a leak. If you find a cracked or damaged part you must replace it before using the heater. Patio Comfort original equipment parts are available from your selling dealer or please call us directly at 949-474-3070. You are calling Irvine, Ca. Our office hours are M-F 7am to 4pm PST.

OPD Cylinders are equipped with a safety feature within the valve that will not allow the tank to be overfilled. Overfilled tanks can create safety issues. Our Patio Comfort heaters also are equipped with a “Flow Limiter” that will restrict the flow of gas to a small percentage of the flow capacity if a leak is detected when the tank valve is opened. Unless the proper gas-tight connection has been made the gas will not flow in the required volume to operate the unit.

To remove the cylinder, merely raise the decorative cover and rest it on the triangular post socket plate. Turn off the valve at the top of the tank, clock-wise, and unscrew the large black hand-wheel attached to the propane regulator. When transporting your cylinder be sure that it is always in an upright position. To install a full tank, place the tank within the tank cage, carefully and completely attach the hand-wheel and open the tank valve counter-clockwise. **IF YOU HEAR OR SMELL GAS TURN THE TANK VALVE OFF (CLOCKWISE) IMMEDIATELY.** Then refer to the leak test section of this manual or check the tank valve for possible leaks.

**PURGE:** (Normal) Each new tank replacement may take up to a minute or so of depressing the control knob in the ‘PILOT’ position to PURGE the hose of air. Simply push and hold the knob in the ‘PILOT’ position while occasionally pushing the igniter button until the pilot remains lit. It can take up to 2 minutes sometimes. You can see the pilot light through the access hole at the base of the heater head.

Please read all safety tips on propane on pages 4, 5 and throughout this manual. Your OPD cylinder will also have helpful hints on the transportation and storage of propane written within the collar of the tank. Propane is an extremely safe and tested fuel but it must be handled with care and respect.

## Placement of the Heater

Your **Patio Comfort outdoor** patio heater is designed for use as temporary comfort heating for your outdoor patio, outdoor decks, outdoor spa areas, pool areas, and other outdoor areas with plenty of fresh air.



The heater is **NOT** designed, approved, or intended for indoor use or enclosed area use such as a garage, commercial building, tents, ice fishing tents, prefabricated buildings or enclosures or other enclosed areas.



The heater is also **NOT** designed for use on moving objects or vehicles such as houseboats, yachts, travel trailers, boats, or other moving devices or vehicles. **Do Not Move Heater with Cylinder Installed or when unit is burning.**



The minimum clearances from combustibles must be maintained at all times. We recommend the heater be no closer than 24 inches from any combustible vertical or horizontal wall or have any combustible material within 24 inches of the top of the reflector.

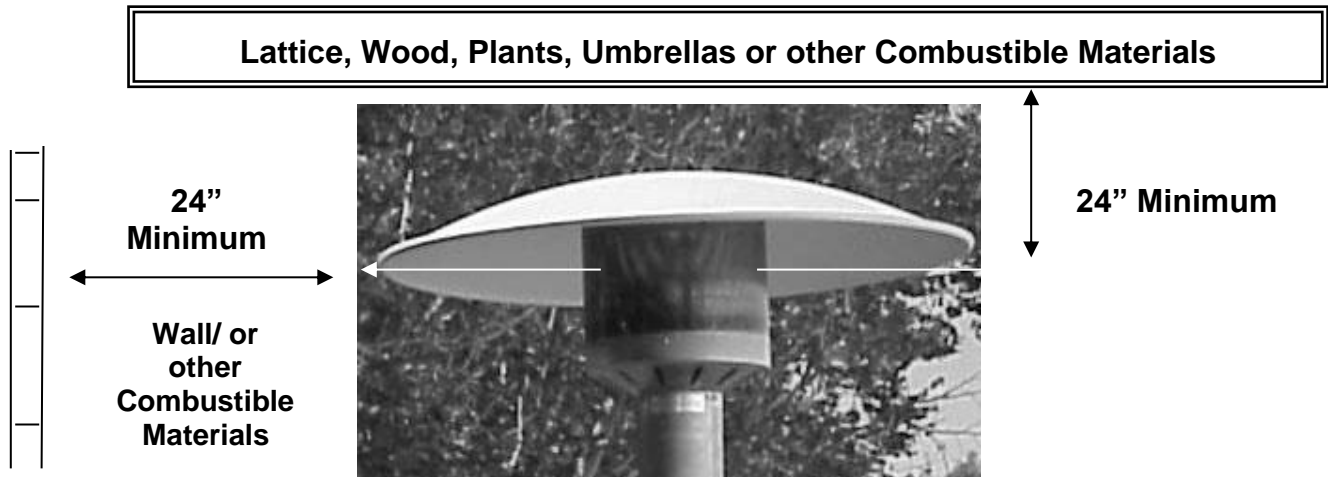

These minimum clearances from combustible materials must be maintained anytime the heater is in operation.

We recommend the heater shall have no combustible materials above the reflector.

The heater must always be used on firm, level, and stable ground. **Never move the heater while it is in operation.**

**WARNING: Never operate heater in an explosive atmosphere and be sure to keep unit away from where gasoline or other flammable liquids or vapors are stored or used.**

## Lighting Instructions

*For your own safety*, please be sure to read and thoroughly understand the sections relating to the proper handling of propane and operation of your heater.

Before turning on the fuel supply at the tank visually inspect the hose assembly for evidence of excessive abrasion, cuts, cracking, animal bites or unusual wear and tear. If the hose leaks it must be replaced prior to using the heater. Only use replacement hoses and other parts as specified by **Patio Comfort**.

### To Light Heater:



**Extinguish any open flames in the area and no smoking.**

- 1) Raise the decorative cover and be sure that the LP regulator is properly engaged into the propane tank.
- 2) Be sure the control knob on the heater head is in the "OFF" position.
- 3) Turn the tank valve in a counter-clockwise direction to open. Note: You may hear a 'sigh' as the gas flows and pressure charges the regulator and the hose, then quiet. **WARNING: IF YOU HEAR OR SMELL GAS TURN THE TANK VALVE OFF IMMEDIATELY. FIND AND CORRECT THE LEAK BEFORE CONTINUING.** Note: If the regulator assembly is not properly engaged into the tank there will be NO flow of gas to the heater. If there is a leak detected by the Acme tank fitting then the flow of gas will be significantly limited.
- 4) Gently depress the control knob on the heater head and rotate it counter clockwise to the "PILOT" position.
- 5) *This is very important!* Gently depress the control knob and hold the control knob to begin the flow of gas to the pilot burner assembly. Continue to depress the control knob in the "PILOT" position for up to **2 minutes**

**on new installations or newly filled tanks.** This is how long it might take for the air to be purged from the hose. It will take less than 10 seconds for subsequent relighting. Do NOT continually press on the igniter while you are purging the line. This will only cause premature wear and tear on the ignition. Occasionally depress the igniter you will hear when the pilot light goes on. You can also see the pilot light through the pilot access port that has a small rectangular cover at the base of the heater head. This is essentially the same safety system that you have on your water heater.

- 6) Once the pilot is lit, continue to depress the control knob for about 20 seconds or until the pilot flame remains lit after the control knob is released.
- 7) The heater may now be turned on to the full “ON” position for maximum heat output. If you turn the control knob all the way back to the “PILOT” position the main burner will go off and the pilot flame will remain lit, you can then re-ignite the main burner directly from the “PILOT” position. A little smoke is to be expected coming from the emitter and reflector at the first firing as the machining oils burn off.

## If you turn the heater off and then have to re-light

- 1) Turn control knob to the “OFF” position.
- 2) Repeat starting with STEP #4. You should not have to wait more than few seconds to re-light the “PILOT” light and then ignite the main burner. If the unit does not re-light as expected then turn it off and allow it to cool for 5 minutes before trying again. If heater does not light using the push button ignitor, try lighting with a long stemmed match. You will see a lighting hole above and to the left of the red ignitor button.

## To Turn Off or Shut Down Heater

- 1) Turn the control knob in a clock-wise direction to the “OFF” position. You may hear a slight popping sound when the main burner shuts down. This is normal.
- 2) Lift the decorative cover up the post and turn the valve on the top of the propane tank in a clock-wise direction to turn it off.

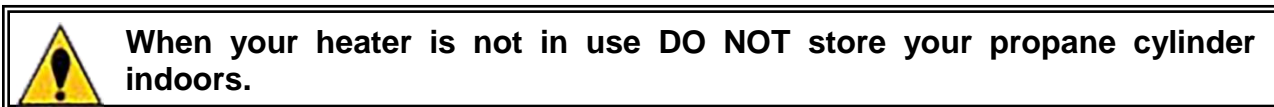

## Storing your Heater and Insect Warning

Be sure control knob is in the “OFF” position and the cylinder valve is CLOSED.

When storing the heater please disconnect the tank from the heater at the regulator and LP cylinder. The tank should be stored outdoors in a well-ventilated area to be in compliance with ANSI Standard and NFPA National Fuel Protection Agency Code 58-1986.

Store your heater in an upright position in an area sheltered from inclement weather such as rain, snow, sleet, hail, dust storms, and other blowing debris.

***Patio Comfort*** makes a cover available to protect the burner head. We strongly recommend using our cover when your heater is in storage or not in use. The Item number for the cover is “PCC-1” This cover is available from your ***Patio Comfort*** retailer or distributor. The cover will help protect the heater head from moisture as well as insects. **CAUTION: Be sure heater is cool to the touch before using the cover**

## **Spider and Insect Warning**

Spiders and other insects are attracted to the smell of natural gas and propane. This is the case for outdoor heaters, gas grills, gaslights and torches, pool heaters, and other outdoor gas burning products. The webs and obstructions created by these insects can cause conditions that may damage the appliance or render it unsafe for proper use. You should inspect the burner at least once a year or immediately if any of the following conditions are present when operating the heater:

1. The odor of gas in conjunction with extreme yellow tipping of the burner flame.
2. The emitter grid does not glow evenly or reach proper operating temperatures.
3. The burner makes a popping or roaring noise.

If you feel uncomfortable working on the heater please contact your servicing dealer or distributor for the name and number of a qualified service technician.

# Cleaning & Maintenance

Your heater has been produced from highly weather resistant materials and only requires minimum cleaning and maintenance. Cleaning must be performed when the heater is cold. Your patio heater will last longer if it is cleaned and maintained properly. It is very important that the air required for the combustion process is not blocked going to the burner. Orifices, burner venturis, vents, and other openings must be kept free of dirt and spider webs.

The heater head should be cleared of soot and debris annually or if the flame characteristics change. Use only compressed air for this maintenance. Never attempt to clean the emitter grid with cleaning solutions. Never spray the heater head with water. A compressor with an air stream nozzle or even 'canned' air will work well. Removing the emitter grid allows access to the pilot and main burner for a 'Blowout'. Any part or component removed for cleaning or maintenance must be properly re-installed before using the heater.

**Stainless steel does not "rust," however varying atmospheric conditions, areas with acid rain, beach and ocean areas with heavy misty conditions may leave deposits on the heater. This is to be expected of any stainless-steel product used outdoors. We recommend washing the outer stainless-steel components such as the post and decorative cover and perforated material around the lighting instructions with a mild detergent solution and immediately wiping it clean with a dry soft cloth. The stainless steel can be expected to darken and discolor around the heater head as it sustains extreme temperatures. This is normal and to be expected with any outdoor gas heating appliance.**

**Never use a cleaning agent that is flammable or corrosive.** There are several excellent stainless-steel cleaners available through your local dealer for our stainless-steel models. If you do not find a suitable local source call us directly and we can provide you with an excellent cleaner. Never spray any cleaning product on the emitter grid or burner area.

If you purchased the painted, powder-coat model, treat it just like you would any other piece of fine outdoor patio furniture. Wash all painted parts of the heater with a soapy solution and protect it with a coat of automobile car wax a couple of times per year or as required dependent upon your local weather and climate conditions.

If you need to touch up a painted heater only paint the post and base portions. Never paint above the post or the LP cylinder. The burner ports must also be kept clear so that the burner burns evenly and the flow of gas is not restricted.

The best protection for the critical heater head is a **Patio Comfort** cover that has been specifically designed for your heater. The cover can be purchased at your heater at your dealer.

The painted powder coat heater post and base may be cleaned with soap and water and occasionally coated with a car wax. Commercially available Stainless-Steel cleaners are best for the Stainless-Steel units. (WD40 works well in a pinch on the SS.

The heater head however should be cleared using compressed air only. These parts are constructed of commercial quality stainless steel and brass and under normal use will require no other maintenance. All Patio Comfort OEM parts are available if you need one.

All Patio Comfort heater head and gas control assemblies are 100% fire-tested prior to packaging. The troubleshooting section below includes many of the most common calls and solutions but time and space limits the comprehensiveness of the table. A pre-season clearing of insects, dirt, dust or debris from the heater head using compressed air is recommended as well as using a cover for the head when it will be stored or not in use for a while. Wiping down the painted and stainless-steel components keeps them looking new.

## TROUBLE SHOOTING GUIDE

If you are having this problem:	If this condition exists:	You will need to do the following:
<b>The pilot light won't light</b>	Cylinder valve is closed Air in gas lines Reg. not fully engaged into tank Low fuel pressure from tank Outside Temperature below 30deg and tank less than ¼ full. Piezo Igniter is not sparking Spider web or debris in the pilot	Open valve at cylinder. (Page 15,16) Purge air (Page 17, step 5) Hand tighten ACME firmly onto tank. 1. Check fuel level. Replace cylinder 2. Check for leaks at connections and correct. Replace tank or go inside. Use a match to light pilot through access hole at base of heater head. Replace igniter if required. Clear pilot with compressed air.
<b>The pilot, after initial lighting, will not stay lit</b>	Leak detected by the safety system. Spider web or debris in the pilot Thermocouple is not operating properly High wind condition blowing out pilot flame	Check connections at the tank, hose and heater head (Page 13, 14) Clear pilot with compressed air. 1. Hold pilot on for full 30 seconds 2. Tighten Thermocouple at the valve 3. Replace thermocouple. Put heater in more protected location. Do not use heater in winds in excess of 10 MPH.
<b>Pilot remains lit but Main burner will not light</b>	Low fuel pressure from tank Leak detected by the safety system. Blockage in main burner orifice Control knob is not in "ON" position	1. Check fuel level. Replace cylinder 2. Check for leaks at connections and correct. Check connections at the tank, hose and heater head (Page 13, 14) Clear blockage with compressed air. Turn knob to "ON" Position
<b>Burner Flame Is Low or Emitter grid does not glow evenly.</b>  <b>Please note: Bottom 1" of emitter grid normally does not glow.</b>	Low fuel pressure from tank Control knob not set to the full "ON" Position Outdoor temperature is below 40 degrees Fahrenheit and tank is less than 20% full.	1. Check fuel level. Replace cylinder 2. Check for leaks at connections and correct. Turn knob to full "ON" to the left. Refill tank and use full cylinder.
<b>Lazy and yellow or orange flames (on used heaters)</b>	Soot carbon built up on burner, emitter and/or reflector.	Remove the emitter grid and clear with compressed air and damp cloth.



## Important Warnings and Safety Points!!!

### For Your Safety:

If you smell gas:

1. Shut off gas to the appliance
2. Extinguish any open flame near the appliance

If odor continues please call your gas supplier

### For Your Safety:

Do not store or use gasoline or other flammable vapor and liquids in the vicinity of this or any other appliance.

### Warning!!!

Improper installation, adjustment, alteration, service, or maintenance can cause physical injury or property damage. Read the instructions thoroughly before installing, operating, or attempting to service this appliance.

### Danger!!!

#### *Some Important Heater Safety and Use Precautions:*

Failure to comply with the precautions and instructions provided with this heater can result in death, serious bodily injury, and property loss or damage from hazards of fire, explosion, burn, asphyxiation, and or carbon monoxide poisoning.

Please be sure you understand all operating instructions before attempting to operate or service this or any appliance.

This appliance is designed and approved for **outdoor use only** (outside of any enclosure). Always be sure there is plenty of fresh air when the heater is in use.

- Always use extreme caution while heater is in operation. Alert both children and adults to the fact that the emitter grid will generate extremely high surface temperatures (1600 degrees plus) and will cause burns if touched. Wait at least thirty minutes before touching any hot portions of heater.
- Always maintain at least a 24" inch clearance in all directions from the heater head to any combustible material.
- Please be sure heater is on a hard level surface. Be sure ballast weight is assembled into base to prevent possible tipping. Never move the heater while it is in operation.
- The LP (Propane) cylinder should always be turned off when the heater is not being used.
- All leak tests should be done with a soapy solution and **NEVER with a match or open flame device.**
- Do not attempt to use the heater if wind conditions exceed 10 miles per hour. It is possible that the high wind will blow the burner flame out. Position the heater so that it is not directly exposed to water spray, rain, and or dripping water or winds.
- Do not use heater if outdoor temperature is below 40 degrees F.
- Do not attempt to paint reflector, emitter grid, or any portion of the heater control assembly.
- Do not attempt to modify or alter the propane regulator that is included with your heater. It is preset at the factory for 11.0 inches water column. This is required for proper operation and safety.

- The heater is equipped specifically for use with propane gas. Do not attempt to use any other fuel unless you properly convert your heater with a factory produced gas conversion kit.
- Please keep water and sprinklers away from heater especially while in use.
- Do not use in a combustible atmosphere. Keep the heater away from areas that have flammable liquids, gasoline, vapors, or explosives stored or used. Do not use the heater inside your garage or other indoor work areas.
- Do not hang clothing or any other combustible materials on or near heater when it is in operation.
- Young children and pets should be closely supervised when the heater is in operation.
- Never hook up the heater to an unregulated propane gas supply line.
- Do not touch the emitter grid or reflector unless the heater has been turned off and cooled for at least 40 minutes.
- To avoid the possible risk of burns or possibly catching clothing or other combustible materials on fire do not touch the heater anywhere close the the emitter grid or burner assembly while the heater is in operation
- Please do not attempt to clean your heater with combustible or corrosive materials.
- Minimum inlet pressure cannot exceed 100 lbs. PSI from the cylinder.
- If certain items are stored under the heater they will be subjected to the radiant heat and may be damaged.
- Do not attempt to alter the heater in any manner whatsoever. The unit has been designed to provide you with many years of trouble free service if maintained per our recommendations.
- Inspect heater before each use. If you find a damaged part, please replace the part with a genuine *Patio Comfort* part before using the appliance.
- Do not attempt to use your heater without the proper factory supplied hose and regulator. Use of unauthorized replacement parts may result in damage to the unit, cause improper operation, and performance, and may cause property damage or bodily injury.
- The purchaser assumes all risk in the assembly and operation of this appliance. Failure to follow this guides warnings and instructions can result in severe personal injury, property damage, or death.
- **Do NOT attempt to move heater while it is in operation.**
- Use this appliance in accordance with local codes and safety ordinances. In the absence of local codes refer to ANSI standard Z223.1
- If you have any questions whatsoever about the assembly or operation of this product please contact your authorized *Patio Comfort* retailer or call us directly at 949-474-3070 or E-mail [info@aeicorporation.com](mailto:info@aeicorporation.com). This product has been designed and constructed to provide you and your family with many years of safe, convenient, outdoor comfort.



## Some tips on propane and the safe use of propane fuel

- Propane (LP GAS) is a very safe fuel if used properly. Propane or liquefied petroleum gas is highly flammable, explosive under pressure, clean burning, heavier than air, and settles or puddles in low areas.
- In its natural form propane gas is odorless. For your safety and for ease of detection an odorant has been added to the propane that smells like rotten cabbage. If you ever believe that you have a propane gas leak in any appliance shut off the appliance immediately and find and correct the leak.
- Direct contact with propane gas can cause freeze burns to the skin.
- Your heater is shipped from the factory to be used with propane fuel only. Do not attempt to alter your heater in any way.
- Use only a “DOT” (Department of Transportation) approved 20-pound cylinder (when it’s empty) with an “ACME” TYPE 1” connection with “QCC” (Quick Connect Coupler). Use only cylinders equipped with an approved OPD “Overfill Protection Device.” This device prevents accidental over-filling and possible escape of fuel when the cylinder is heated. These OPD equipped cylinders can be easily identified by their triangular handle at the top of the tank and inside and outside threads where the regulator attaches to the cylinder valve. Do NOT attempt to alter or modify any parts of this safety system!
- Never attempt to use a cylinder that has a rusted or damaged main body, a damaged collar or valve, or a damaged foot ring. Take your cylinder to an authorized propane retailer if you have any questions whatsoever about the safety or suitability of your cylinder...they’re experts!
- Whenever you’re not using the heater be sure to turn the tank off at the valve and the heater off at its control valve.
- **New regulators with ACME QCC (Black hand-wheel) tank fittings also contain a device that senses leaks in your heaters fuel system. If you find that the pilot light lights and ignites the burner only to find that it shuts down within a minute or two this could indicate that the safety system has detected a leak in either the hose or at the various connections of the heater head. Check all fittings with a soapy solution and then attempt to re-light.**
- On all new OPD cylinders the regulator assembly and hand wheel must be completely and correctly engaged and tightened into the cylinder valve or it will not allow the gas to flow to the heater. Be sure this connection is tight but do not over-tighten. You do not need to use any tools to make this connection. You can also double-check this connection at the cylinder with a soap and water solution...never with an open flame!
- Never store a propane cylinder indoors. If you are not using the heater disconnect the cylinder from the heater and store it outdoors in a shaded area where it is not accessible to children.
- Never paint a propane cylinder any other color than what is provided by the cylinder manufacturer.
- We recommend that you use 20 lb. OPD equipped propane cylinders made in the U.S. by either Worthington Cylinder or Manchester Tank. These are high quality propane cylinders that are constructed to the highest in manufacturing standards, safety standards, and quality standards
- We recommend using only authorized propane filling stations or nationally recognized cylinder exchange companies. If you are unsure about the quality of the cylinder, mechanical integrity, or if the

safety systems are operating properly do NOT use the cylinder and return it promptly to a qualified propane re-filler.

- If this heater is being used in a commercial or rental installation or application it is the responsibility of the purchaser to check with the local codes and ordinance officials, local fire officials, or safety officials to be sure that heaters equipped for use with propane gas are acceptable. Be sure to find out if there are specific restrictions or regulations that relate to the storage of multiple propane cylinders in a commercial installation.
- We make no claims as to the suitability of this product for any commercial or residential application.

## **Service & Warranty Information**

To learn how to service and acquire replacement parts first contact your selling dealer or call us directly at 949-474-3070 or e-mail us at [info@aeicorporation.com](mailto:info@aeicorporation.com) for assistance. Please provide us with the model number and serial ID number for best possible service and support. Please be sure to fill-out your Patio Comfort Warranty card so that we can have you on file. We will not use this information for any marketing activities.

Our company has been in the quality leisure gas appliance business since 1966 and we want to be sure that you are happy with our products and support services.

Be sure to use only genuine *Patio Comfort* replacement parts for your heater. Use of unauthorized parts or modification of our parts will void the heater warranty and could create personal injury or property damage.

Always be sure that your heater is cool to the touch before attempting any service or maintenance procedures.

# Warranty

***Patio Comfort*** heaters are warranted against manufacturer's defects in parts for a period of 1 year from the date of purchase with original purchase receipt. We will warranty against structural defects of all external stainless-steel components (posts, bases, & decorative covers) for 5 Years from date of purchase.

The ONE YEAR Consumer warranty is only applicable for consumer or residential applications. We offer a 120-day limited warranty on our heaters that are used in a commercial or rental application. Commercial warranty does NOT warranty emitters, igniters, burners or component failure caused by abuse, transportation, or misuse.

This warranty is valid from the original date of purchase and is transferable. Please keep your original sales receipt or invoice. Proof of purchase is required to obtain warranty replacement. ***Patio Comfort*** retail dealers or distributors do NOT have the authority to modify, alter, or in any way change the product or the terms and conditions of this warranty.

## **Patio Comfort does NOT cover:**

- Freight charges to our facility in Irvine, California (We will pay the 'return to you' freight costs within the warranty period)
- Assembly or installation costs
- Improper assembly or improper hook-up
- Damage or repairs that result from spiders or other insect nesting
- Damage due to weather conditions or lack of proper maintenance and cleaning
- Normal maintenance or burner adjustments
- Cleaning or periodic general maintenance
- Shipping or freight damage
- Service provided by an unauthorized agency or service person
- Overtime, weekends, and holidays
- Service visits to correct improper assembly or installation.
- Damages caused by abuse, accident, acts of nature, vandalism, transportation, or alteration
- We will not repair rented heaters that have been repurchased for residential use
- ***We will not cover normal wear and tear such as discoloration to the finish, scratches, chips, abrasion, or fading from exposure to sunlight or other atmospheric conditions.***

## Your Legal Rights

- CONSEQUENTIAL DAMAGES, INCIDENTAL DAMAGES, OR EXPENSES INCLUDING DAMAGES TO PROPERTY. SOME STATES/PROVINCES DO NOT ALLOW THE EXCLUSION OR LIMITATION OF INCIDENTAL OR CONSEQUENTIAL DAMAGES, SO THE ABOVE LIMITATION OR EXCLUSION MAY NOT APPLY TO YOU. WE WILL NOT BE RESPONSIBLE FOR ANY COSTS RELATING TO LOST REVENUE, BUSINESS INTERRUPTION, OR ANY LEGAL THEORY UPON WHICH ANY CLAIM MAY BE BASED.
- PURCHASER ASSUMES ALL RISK IN THE ASSEMBLY AND OPERATION OF THIS APPLIANCE. FAILURE TO FOLLOW THIS MANUAL'S WARNINGS AND INSTRUCTIONS CAN RESULT IN SEVERE PROPERTY DAMAGE, PERSONAL INJURY, OR DEATH.

This warranty is for all ***Patio Comfort*** heaters purchased and used in the 50 US states, The District of Columbia and Canada. This warranty applies even if you should move during the warranty period. Should you sell the product during the warranty period the warranty protects the new owner as well. This warranty provides you with specific legal rights. You may also have other rights that vary from state to state.

How to obtain service:

For most product or assembly related problems your selling dealer can provide you with help. The product has been designed to be as trouble-free and maintenance free as possible and requires minimal assembly. Should you have a problem with missing parts please contact your selling dealer or contact us directly at 949-474-3070. We exercise extreme care in the assembly and manufacturing process but we know errors can be made and we want to take care of them as quickly and painlessly as possible.

Since product improvement is an ongoing process we reserve the right to change this products materials, specifications, or design without notice. We know that you and your family will enjoy your ***Patio Comfort*** heating product for many years to come and that it will be a welcome addition and important ingredient to your outdoor entertainment and activities.

**Page intentionally left blank for owner notes**

Cut along dotted  
line and mail or fax

# Patio Comfort Heaters Warranty Registration Form

**Please return this warranty registration card within 10 days**

Congratulations on purchasing a **Patio Comfort** Model PC-02 Outdoor Heater. To ensure that you'll get all of the warranty protection that comes with the purchase of this fine product please fill out the Warranty Registration Form and send it back to us **within 10 days of purchase**.

**Rest assured that your registration information is for our information and tracking only and will NOT be used by any other company or organization.** Appliance manufacturers are required to keep detailed design, component, production, testing, and manufacturing information in the event there is ever a defective part or we need to quickly contact our customers regarding any added safety information regarding our products. Your cooperation in this tracking system is extremely important. Please fill out the information below as completely as possible.

**Last Name** \_\_\_\_\_ **First Name** \_\_\_\_\_ **Middle Initial** \_\_\_\_\_

**Date of Purchase Month** \_\_\_\_\_ **Day** \_\_\_\_\_ **Year** \_\_\_\_\_

**Model of Heater** \_\_\_\_\_ **Fuel Type** \_\_\_\_\_

**Serial Number of Heaters Purchased:**

\_\_\_\_\_  
\_\_\_\_\_  
\_\_\_\_\_

**Name of Selling Dealer** \_\_\_\_\_

**Address of Selling Dealer** \_\_\_\_\_

**Your Home Address** \_\_\_\_\_ **State** \_\_\_\_\_ **Zip** \_\_\_\_\_

**E-mail address (optional)** \_\_\_\_\_

Thanks again for your purchase please mail this today so that we can activate your warranty information.

**Please mail or fax to:**

**AEI Corporation  
C/O Warranty Registration Department-Patio Comfort  
PO Box 16097  
Irvine, California 92623-6097**

*Patio Comfort*, Proudly Manufactured by:





To see our full array of patio heating and premium gas grilling equipment scan the above code or visit our website:

[www.aeicorporation.com](http://www.aeicorporation.com)

---

---

---

Postage  
Required

AEI CORPORATION  
Warranty Registration Department  
PO BOX 16097  
Irvine, CA 92623-6097