

CLEARANCES & INSTALLATION MANUAL BIOETHANOL ONLY

Please read these instructions and the Burner Operations Manual provided with your burner completely before operating the appliance.

REFER TO THE OPERATIONS MANUAL IN THE BURNER PACKAGING FOR CLEARANCE AND INSTALLATION INSTRUCTIONS IF USING PROPANE OR NATURAL GAS.

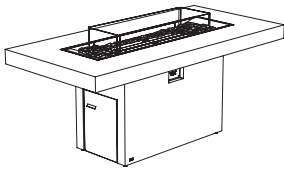

Gin 90 Bar
Concrete 180.5kg, 397.1lbs
Teak 133kg, 292.6lbs

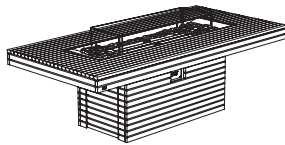

Gin 90 Dining
Concrete 172.5kg, 379.5lbs
Teak 128kg, 281.6lbs

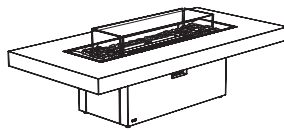

Gin 90 Chat
Concrete 162.5kg, 357.5lbs
Teak 119kg, 261.8lbs

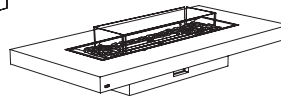

Gin 90 Low
Concrete 154.5kg, 339.9lbs
Teak 100kg, 220lbs

e-nrg[®]
natural . renewable . green

e-NRG is the ONLY fuel to
be used in this appliance.

www.e-nrg.com
www.e-nrg.com.au

! WARNINGS:

IF THE INFORMATION IN THIS MANUAL IS NOT FOLLOWED EXACTLY, A FIRE OR EXPLOSION MAY RESULT CAUSING PROPERTY DAMAGE, PERSONAL INJURY OR LOSS OF LIFE.



Do not fill
while hot



Do not fill while
operating



Do not overfill



Flammable

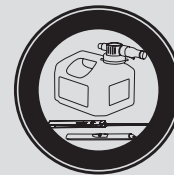

Use with supplied
accessories



Keep away
from children

Fireplace Clearances

When using Bioethanol as a fuel source this model is suitable for indoor and outdoor use.

Before installation ensure that the model is positioned in accordance with the compulsory minimum clearances outlined below.

If used indoors ensure that you pay attention to the Minimum Room Size below:

| | |
|-------|--|
| XL900 | 110m ³ [3884ft ³] per burner |
|-------|--|

WARNING: Ensure that your fire is positioned away from flammable materials and other sources of ignition at all times. Pay very close attention to positioning the fire away from items that may move as a result of wind and drafts. For example trees/branches/paper and the like.

The base of the burner within the model must never come into direct contact with flammable materials.

Side clearances to fixed and stable furniture items that are not susceptible to movement (e.g. lounges or patio furniture) must remain a minimum of 600mm [23.6in] away from the flame at all times.

Overhead clearances to items that are susceptible to movement (e.g. Trees) must remain a minimum of 2000mm [78.7in] away from the flame at all times.

These products feature 360° height-adjustable articulating feet. Adjust the feet by turning them in either direction until you achieve a perfectly level and stable model before operating.

Stainless steel will rust or corrode over time if contamination or debris is not cleaned or removed immediately. Always use the Burner Lid included with your model to avoid dust and debris from accumulating inside the burner.

If you live in extreme weather conditions where accumulation of snow is likely, use of the Winter Bag is imperative in order to be covered by the warranty.

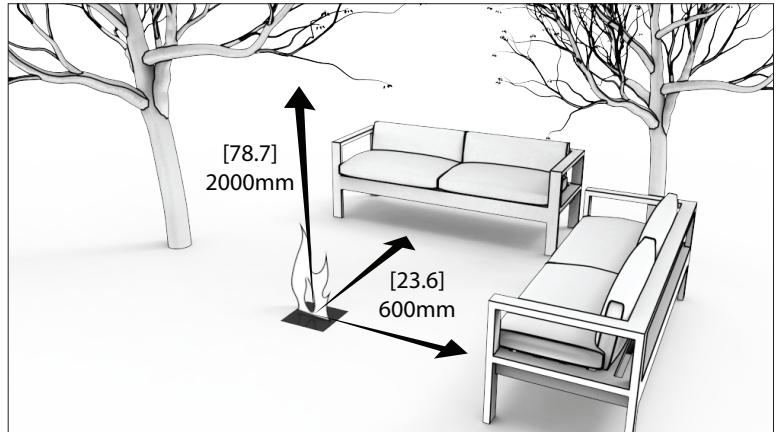

1. Outdoor Clearances

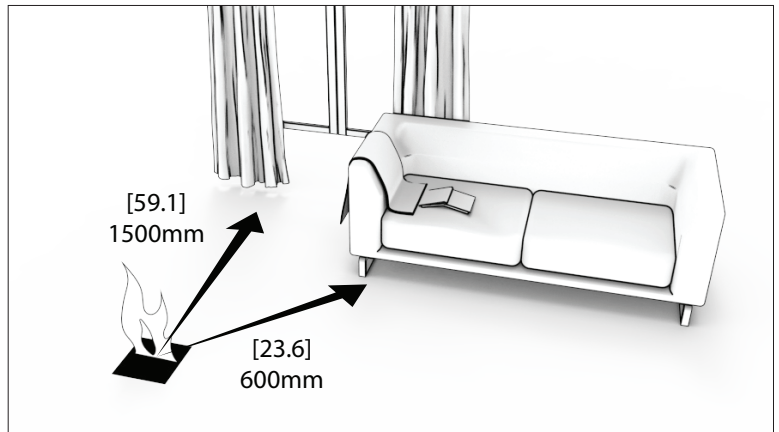

2. Indoor Clearances

Fireplace Installation

1. Confirm you have received all necessary parts as illustrated.

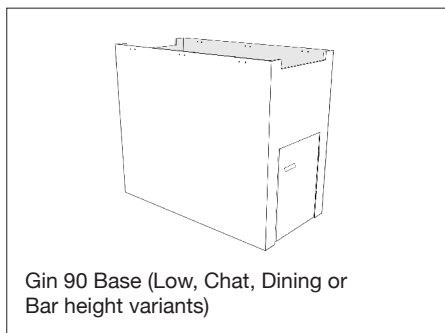
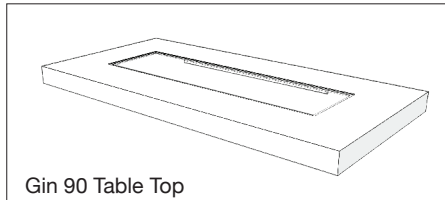
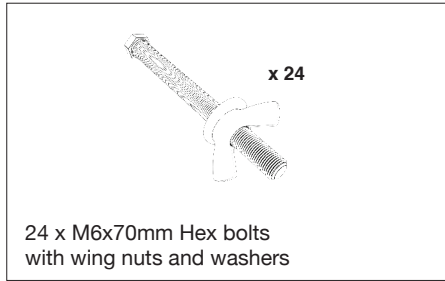

2. These models come with Ground Fixing Brackets so they can be installed in a fixed position. Follow the instructions supplied with the Ground Fixing Brackets to complete the installation of the product.

3. NOTE: Height extension brackets are available as an optional part to lift your table top by an additional 76mm [3in].

If applicable, follow the instructions supplied with the Lift Kit before proceeding with step 4.

4. Carefully align the Gin 90 top and table base. Ensure the 6 fixing points are aligned.

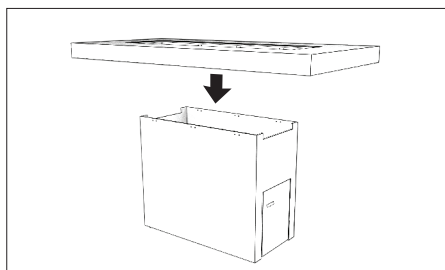

5. Disassemble the Nut and bolt sets. Insert the flange bolts from the underneath of the table top where the fixing positions are aligned. Insert the bolt with the thread facing inwards.

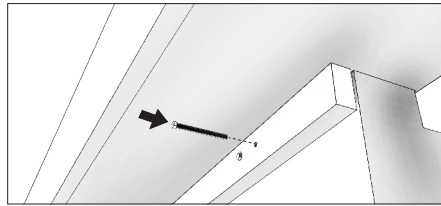

6. Once the bolts have been fully pushed through its fixing positions, install the washer and secure tightly using the wing nut.

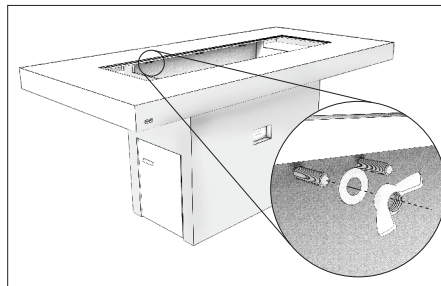

7. Insert the metal tray into the base.

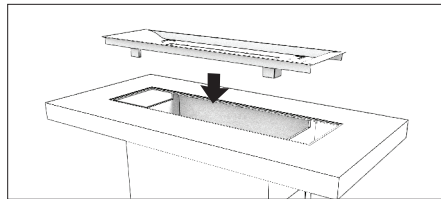

8. For Indoor Installations insert the Indoor Safety Tray. The appliance must not be operated indoors without the Safety Tray installed.

For outdoor installation go to Step 9.

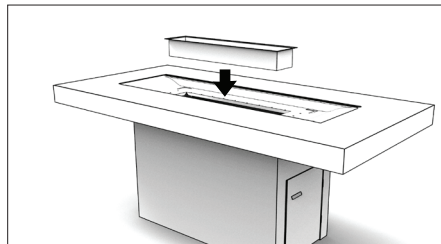

9. Insert Burner into metal tray.

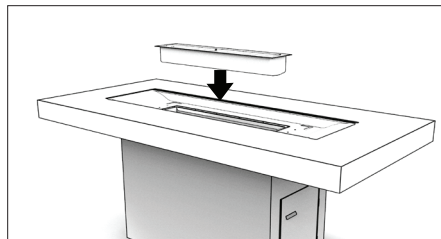

10. Insert Glass Screen. (If applicable).

Align each glass screen tab with the designated slots in the metal tray, gently put into position. Exercise caution so as not to fracture or damage glass.

If included as a standard part (compulsory in the USA), the appliance must not be operated without the glass screen installed.

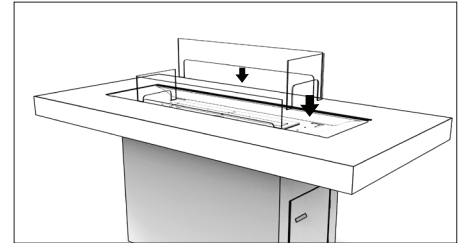

11. Add glass charcoal around the burner - be careful not to scratch the burner surface.

Do not place glass charcoal on top of the burner or where they can interfere with the operation of the burner or the flame.

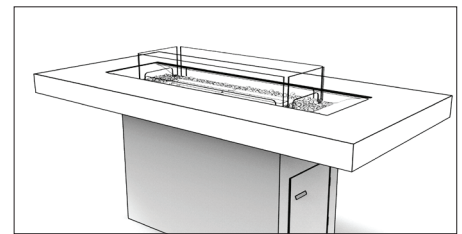

DO NOT STORE FLAMMABLE LIQUID UNDER TABLE.

CAUTION: No other items should be stored within the Table Base cavity while the fire is in operation.



OPERATE ACCORDING TO THE BURNER OPERATIONS MANUAL INCLUDED WITH THE BURNER.

Abstände zur Feuerstelle

Bitte lesen Sie diese Anleitung sowie die Gebrauchsanleitung, die Sie mit dem Brenner erhalten haben sorgfältig und komplett durch, bevor Sie Ihre Feuerstelle in Betrieb nehmen. **ALLE ABSTÄNDE UND INSTALLATIONSANWEISUNGEN FÜR DIE VERWENDUNG VON PROPAN- ODER ERDGAS FINDEN SIE IN DER BEDIENUNGSANLEITUNG DES BRENNERS.**

Diese Modelle eignen sich nur für den Einsatz im Freien / Outdoor.

Vor der Installation stellen Sie sicher, dass die Feuerstelle gem. den unten benannten erforderlichen Mindest-Abständen platziert wurde.

Bei der Verwendung in Innenräumen, bitte die Mindest-Raumgröße beachten, siehe unten:

| | |
|-------|---|
| XL900 | 110m ³ [3884ft ³] pro Burner |
|-------|---|

ACHTUNG: Stellen Sie sicher, dass das Feuer jederzeit in sicherem Abstand von brennbaren und leicht entflammaren Materialien positioniert ist. Achten Sie v.a. darauf, dass das Feuer in sicherer Entfernung von beweglichen bzw. windanfälligen Gegenständen oder Materialien aufgestellt wird, wie z.B. Pflanzen, Bäumen, Vorhängen, Papierdekorationen o.Ä.

Die Unterseite des Burners darf niemals und zu keiner Zeit mit brennbaren bzw. leicht entflammaren Materialien in Berührung kommen.

Der seitliche Abstand der Flamme zu schweren bzw. fest platzierten Einrichtungsgegenständen, die nur unter hohem Aufwand bewegt werden können, wie z.B. Lounge- oder Terrassen-Möbel, sollte mindestens 600mm (23.6 inch) betragen.

Der Mindest-Abstand der Flamme zu leichten, wind- und bewegungsanfälligen Stoffen oder Dingen (wie Ästen, Bäumen o.Ä.) muss jederzeit 2000 mm [78.2 in] betragen.

Diese Modelle verfügen über 360° höhenverstellbare Füßchen. Bevor Sie die Feuerstelle in Betrieb nehmen, stellen Sie die entsprechende Höhe der Füßchen durch Drehen in die eine oder andere Richtung ein, bis das Modell sicher und stabil in der Waage platziert wurde.

Edelstahl korrodiert bzw. rostet mit der Zeit, falls Verschmutzungen oder Nässe nicht unmittelbar entfernt werden. Verwenden Sie stets, die mit Ihrem Modell mitgelieferte Burner-Abdeckung, damit Staub und Ablagerung innerhalb des Burners vermieden werden.

Sollten extreme Witterungsbedingungen vorherrschen und Schnee wahrscheinlich sein, so ist die Benutzung der Wintertasche vorgeschrieben, damit die Garantie nicht erlischt.

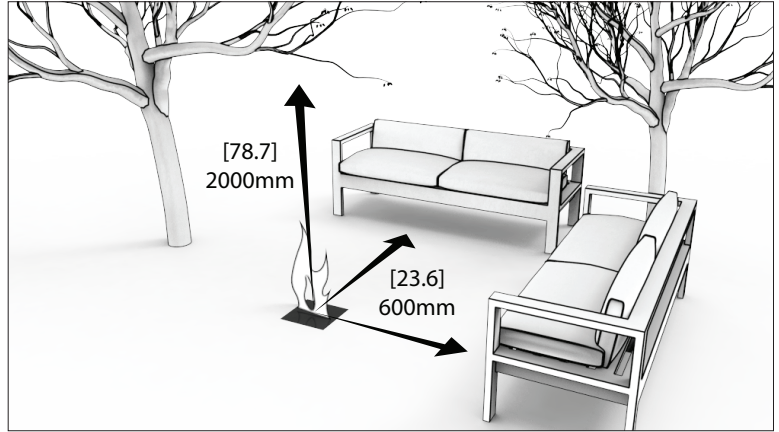

Sicherheitsabstände im Außenbereich

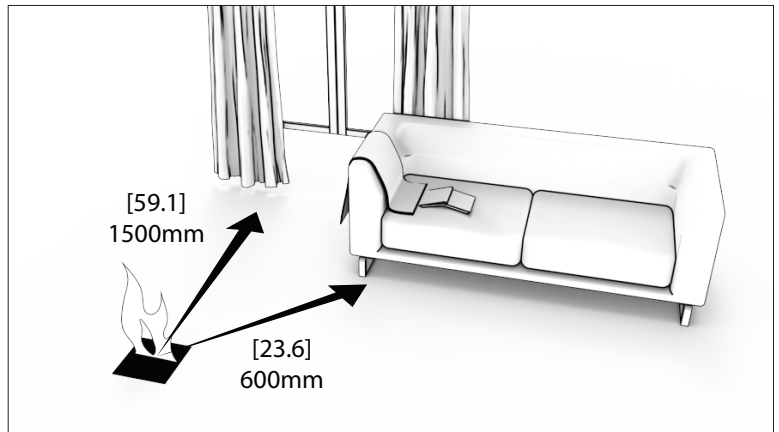

Sicherheitsabstände im Innenbereich

Fireplace Installation

1. Prüfen Sie, ob Sie alle dargestellten Teile erhalten haben.

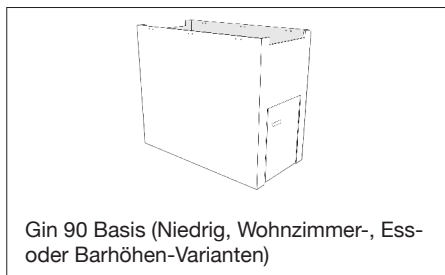
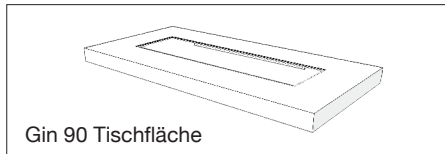

2. Diese Modelle sind mit Bodenhaltewinkeln ausgestattet, damit sie in einer festen Position montiert werden können. Folgen Sie den Anweisungen, die mit den Bodenhaltewinkeln geliefert werden, um die Montage des Produkts abzuschließen.

3. **HINWEIS:** Höhenverlängerungshalterungen sind als optionales Zubehör erhältlich, um Ihre Tischplatte um weitere 76 mm anzuheben.

Befolgen Sie gegebenenfalls die mit den Höhenverlängerungshalterungen gelieferten Anweisungen, bevor Sie mit Schritt 4 fortfahren.

4. Richten Sie die Gin 90-Oberfläche und Tischbasis aufeinander aus. Richten Sie die 6 Befestigungspunkte aufeinander aus.

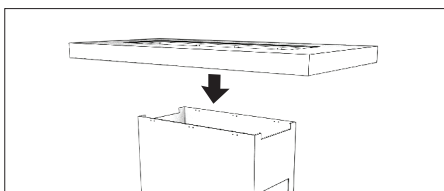

5. Packen Sie die Sets mit Muttern und Bolzen aus. Führen Sie die Flanschbolzen von unten durch die Tischfläche ein, und zwar dort, wo die Befestigungspunkte aufeinander ausgerichtet sind. Führen Sie den Bolzen mit dem Gewinde nach innen gerichtet ein.

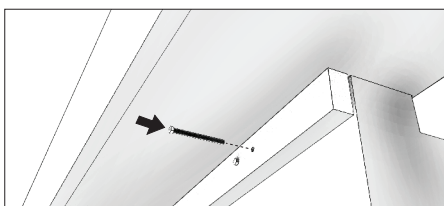

6. Sobald die Bolzen vollständig durch die Befestigungspositionen gedrückt wurden, bringen Sie die Unterlegscheiben an und ziehen Sie das Ganze sicher mit der Flügelmutter fest.

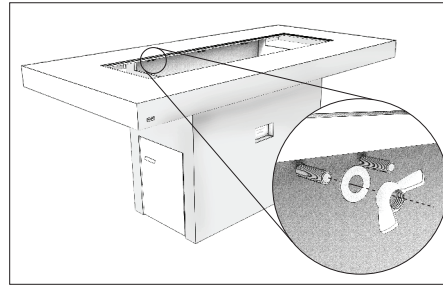

7. Setzen Sie das Metallblech in die Halterung ein.

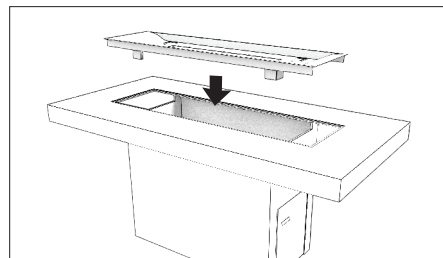

8. Bei Installationen in Innenräumen, das Innenraum-Sicherheitsblech einsetzen. Der Burner darf in Innenräumen nicht ohne eingesetztes Sicherheits-Blech betrieben werden.

Bei Installationen im Außenbereich zu Schritt 9 wechseln.

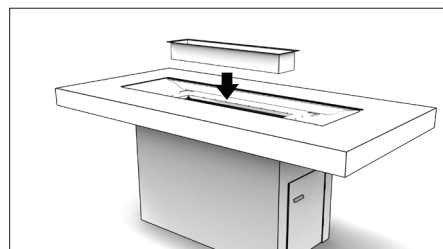

9. Setzen Sie den Burner in das Metallblech ein.

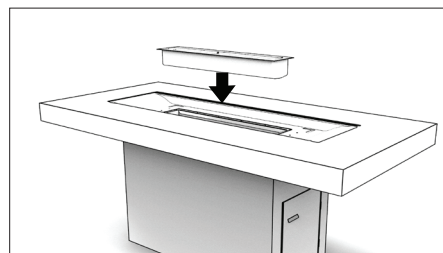

10. Die Glasscheibe einsetzen. (Wenn anwendbar).

Richten Sie jede Glasplatte auf die entsprechenden Fugen im Metalltablett aus und bringen Sie diese vorsichtig in Position. Gehen Sie dabei sehr vorsichtig vor, um das Glas nicht zu beschädigen.

Wenn das Gerät als Standardteil enthalten ist (in den USA obligatorisch), darf es nicht ohne installierte Glasscheibe betrieben werden.

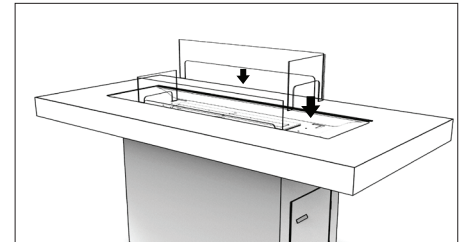

11. Platzieren Sie die Kohlepartikel-Glassteine um den Brenner – seien Sie vorsichtig, dass Sie dabei die Brenner-Oberfläche nicht beschädigen oder zerkratzen.

Platzieren Sie **NIEMALS** die Kohlepartikel-Glassteine auf dem Brenner oder über der Brenner-Öffnung oder dort, wo sie mit der Flamme während des Betriebs des Brenners in Konflikt geraten könnten.

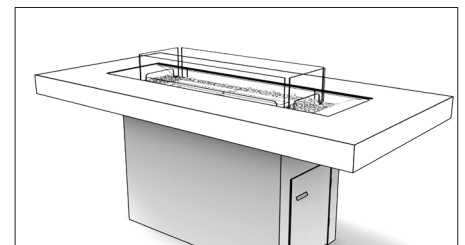

BEWAHREN SIE KEINE BRENNBAREN SUBSTANZEN UNTERHALB DES TISCHES AUF.

VORSICHT: Während das Feuer brennt, sollten im Innenraum der Tischbasis keine weitere Gegenstände aufbewahrt werden.



NEHMEN SIE DEN BRENNER ENTSPRECHEND DER BEDIENUNGS- UND INSTALLATIONS-ANLEITUNG, DIE JEDEM BRENNER BEIGEFÜGT IST, IN BETRIEB.

Dégagements pour les Cheminées

Veillez lire ces instructions dans leur intégralité ainsi que le manuel fourni avec votre brûleur avant de faire fonctionner l'appareil. REPORTEZ-VOUS AU MANUEL DANS L'EMBALLAGE DU BRÛLEUR POUR LES DÉGAGEMENTS ET INSTRUCTIONS D'INSTALLATION EN CAS D'UTILISATION AU GAZ NATUREL OU PROPANE.

Ces modèles sont adaptés à une utilisation en extérieur.

Avant l'installation vérifier que le modèle est positionné conformément aux distances minimales obligatoires décrites ci-dessous.

En cas d'utilisation à l'intérieur, veillez à respecter les dimensions de pièce minimales ci-dessous :

| | |
|--------------|--|
| AB8/ AB8(EN) | 116m ³ [4096ft ³] par Brûleur |
|--------------|--|

ATTENTION : Assurez-vous que votre cheminée est constamment positionnée loin de matériaux inflammables et d'autres sources d'ignition. Faites très attention à positionner le feu loin des objets / choses susceptibles de se déplacer en raison du vent et des courants d'air. Par exemple, les arbres / branches/ rideaux / papiers, etc.

La base du brûleur au sein du modèle ne doit jamais entrer en contact direct avec des matières inflammables.

Les dégagements latéraux pour les meubles fixes et stables tels que les canapés ou autres meubles de salon doivent toujours rester à un minimum de 600mm de la flamme.

Les dégagements généraux pour des éléments susceptibles de mouvement (par exemple : Arbres) doivent toujours rester à un minimum de 2000mm de la flamme.

Ces produits se caractérisent par un pied qui s'articule à 360 degrés. Régler les pieds en les tournant dans le sens souhaité jusqu'à ce que le modèle soit droit et stable avant utilisation.

L'acier inoxydable rouillera ou corrodéra au fil du temps en cas de contamination ou de débris n'ayant pas été nettoyés ou supprimés immédiatement. Utilisez toujours le couvercle du brûleur fourni avec votre modèle pour éviter l'accumulation de poussière et de débris à l'intérieur du brûleur.

Si vous vivez dans des conditions climatiques extrêmes où l'accumulation de neige est probable, l'utilisation du sac d'hiver est impérative afin d'être couvert par la garantie.

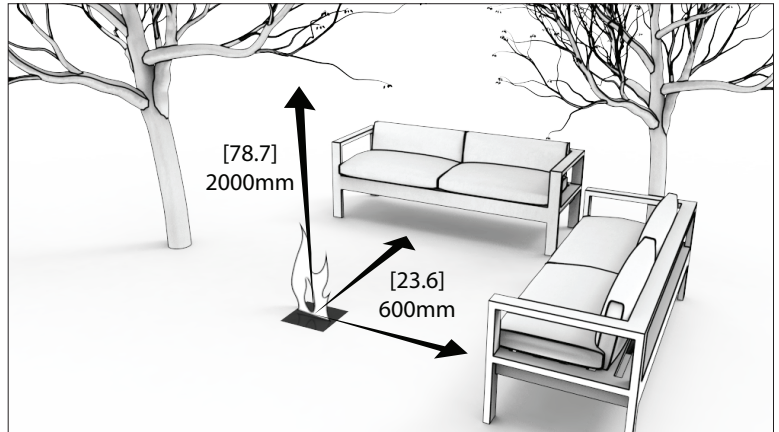

Dégagements Extérieur

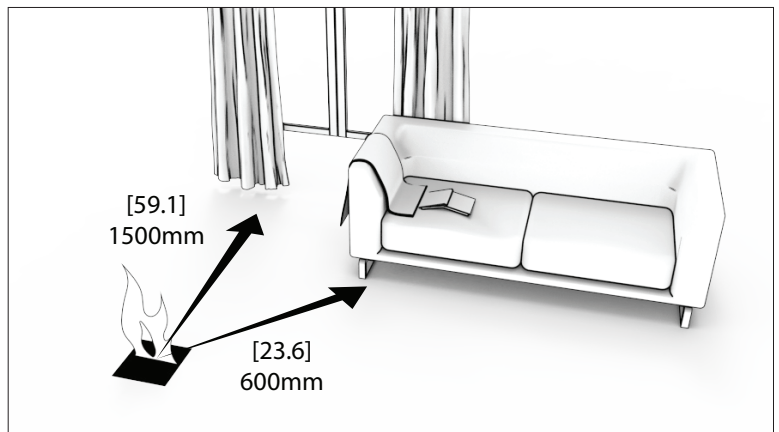

2. Dégagements Intérieur

Installation des Cheminées

1. Vérifiez que vous avez bien reçu toutes les pièces nécessaires, telles qu'illustrées.

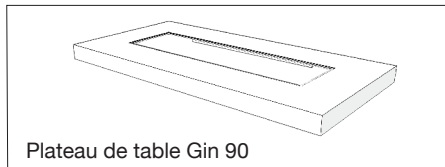
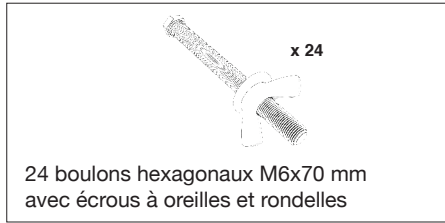

2. Ces modèles sont livrés avec des supports de fixation au sol afin qu'ils puissent être installés dans une position fixe. Suivez les instructions fournies avec les supports de fixation au sol afin de compléter l'installation du produit.

3. REMARQUE: Les supports d'extension de hauteur sont disponibles en option pour soulever le dessus de votre table de 76 mm [3 pouces] supplémentaires.

Le cas échéant, suivez les instructions fournies avec les supports d'extension en hauteur avant de passer à l'étape 4.

4. Alignez soigneusement le plateau Gin 90 et la base de la table. Assurez-vous que les 6 points de fixation sont alignés.

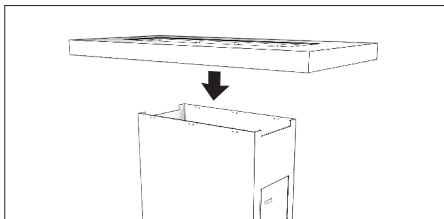

5. Démontez les jeux d'écrous et de boulons. Insérez les boulons de bride par le dessous du plateau de table à l'endroit où les positions de fixation sont alignées. Insérez le boulon avec le filetage vers l'intérieur.

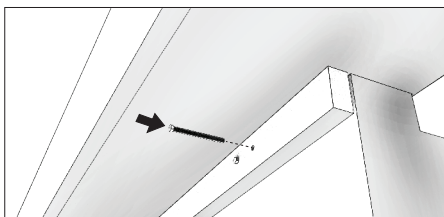

6. Une fois que les boulons ont été complètement poussés dans leurs positions de fixation, installez la rondelle et fixez-la fermement à l'aide de l'écrou à oreilles.

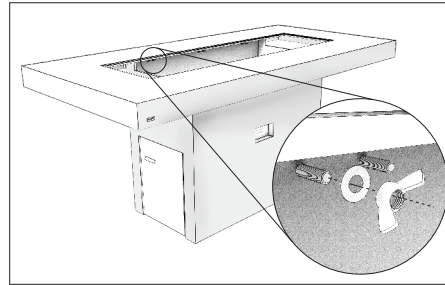

7. Insérez le plateau métallique dans la base.

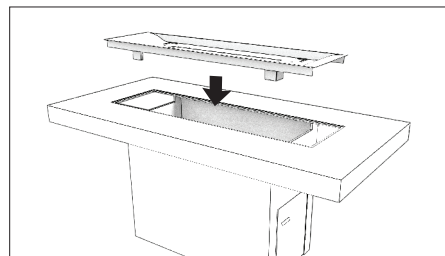

8. Pour les installations à l'intérieur, insérez le plateau de sécurité pour l'intérieur. L'appareil ne doit pas être utilisé à l'intérieur si le plateau de sécurité n'est pas installé.

Pour l'installation à l'extérieur, passez à l'étape 9.

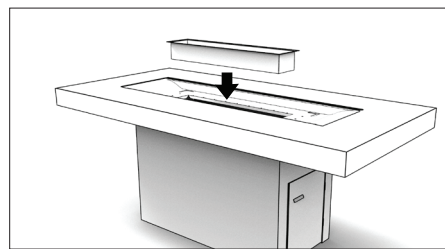

9. Insérez le brûleur dans le plateau métallique.

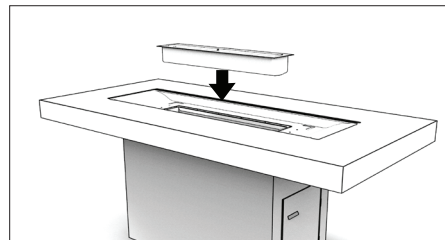

10. Insérez l'écran en verre. (Le cas échéant).

Alignez chaque languette de l'écran de verre avec les fentes prévues à cet effet dans le plateau métallique, puis mettez-la doucement en place. Soyez prudent afin de ne pas briser ou endommager le verre.

S'il est inclus en tant que pièce standard (obligatoire aux États-Unis), l'appareil ne doit pas être utilisé sans l'écran en verre installé.

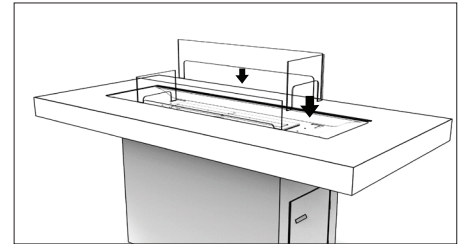

11. Ajoutez le verre anthracite autour du brûleur - Attention à ne pas rayer la surface du brûleur.

Ne placez pas de verres anthracites sur le dessus du brûleur où ils peuvent interférer avec le fonctionnement du brûleur ou la flamme.

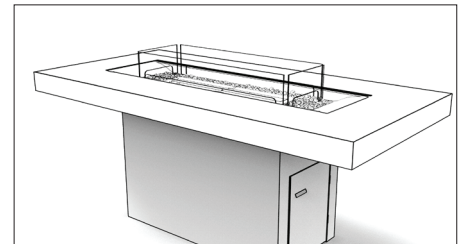

N'ENTREPOSEZ PAS DE LIQUIDE INFLAMMABLE SOUS LA TABLE.

ATTENTION : Aucun autre objet ne doit être entreposé dans la cavité de la base de la table pendant que le feu est en marche.



UTILISEZ L'APPAREIL EN ACCORDANCE AVEC LE MANUEL FOURNI AVEC LE BRÛLEUR.

预留壁炉间隙

使用酒精火炉产品前，请先仔细阅读产品配套的安装，操作和维修指南手册。如果使用煤气或天然气火炉产品，请参照产品包装内提供的操作指南手册进行安装。

此类壁炉可于户外或室内使用。

安装前，请确保产品的摆放参照以下给出的最小预留间隙。

如果在室内使用，请注意下文列出的最小房间尺寸：

| | |
|-------|---|
| XL900 | 每个燃烧器最小空间要求 110m ³ [3884ft ³] |
|-------|---|

警告：任何时候请确保壁炉远离易燃物品与明火，如树枝，窗帘，碎纸等可燃物。小心火焰的位置会因为风而引起火苗的晃动点燃物品。

任何情况下，壁炉内的燃烧器都不可与易燃物品直接接触。

对于位置固定的家具，如客厅或户外的环境下，任何情况下请确保壁炉产品与家具保留至少60厘米以上的间距。

对于壁炉上方可飘动的物件，如树木等，任何情况下请确保壁炉与此类物品保留至少2米以上的间距。

此类产品附带360°可调节脚垫。通过调整脚垫的角度可确保您在水平与稳定的最佳效果下安全使用火炉产品。

燃烧器表面上的污渍如不常清理，不锈钢的表面会随着日常的使用而缓慢生锈。请务必使用您所购买产品附带的防护罩，以避免燃烧器内灰尘和碎屑堆积。

如您居住地区的会有积雪，气候条件较为极端，则有必要使用冬季套装，以便享受质保。

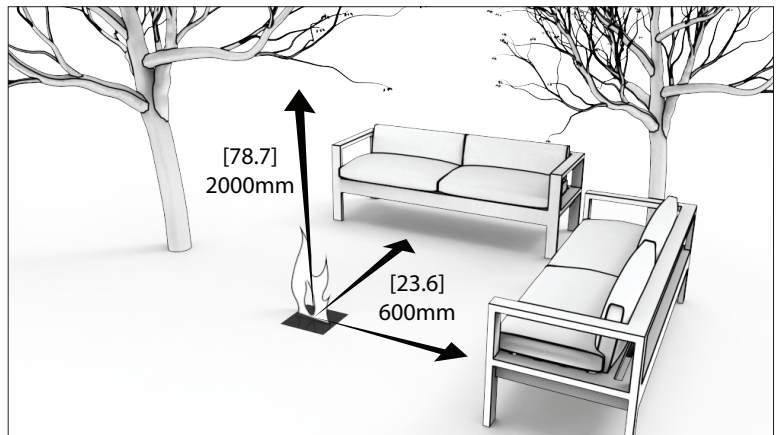

户外安装

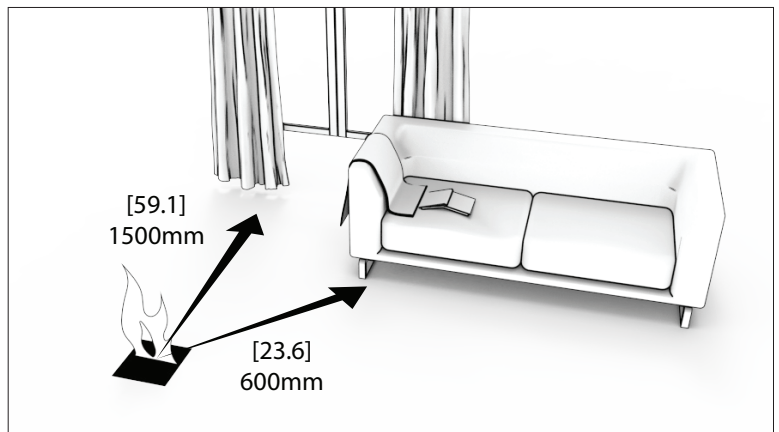

室内安装

安装壁炉

1. 确认您已经接收到如图所示的所有必要部件。

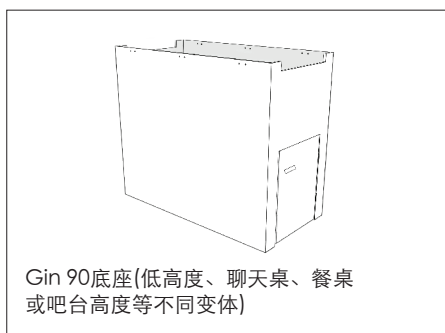
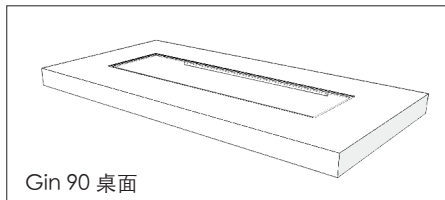
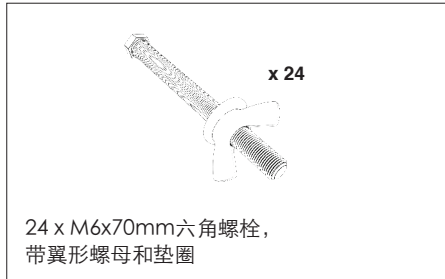

2. 此类产品配有地钉紧固件，可以固定位置安装。请参阅紧固件安装说明完成安装。

3. 说明：加高支架为可选配件，可额外抬高76mm [3in]的桌面高度。

如需使用此配件，请参照配件附带的说明书进行安装在进行第4步骤。

4. 小心地对齐Gin 90桌面和桌面。确保6个固定点对齐。

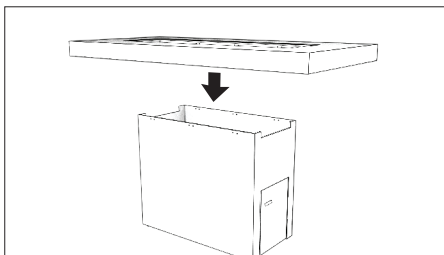

5. 拆卸螺母和螺栓装置。从桌面下方固定位置对准的位置插入法兰螺栓。插入时螺栓的螺纹要朝里。

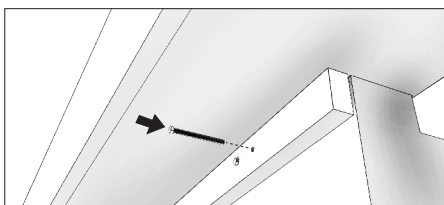

6. 螺栓完全插入固定位置后，安装垫片，并使用翼形螺母拧紧

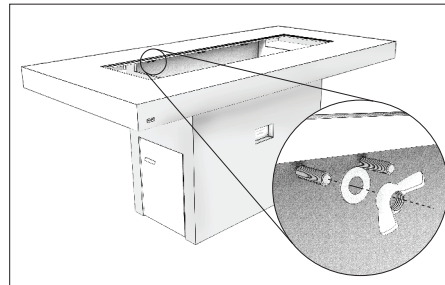

7. 将金属托盘放入底座中。

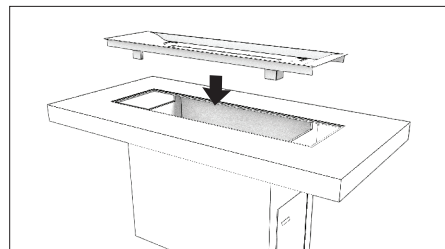

8. 要进行室内安装，请放入室内安全托盘。在没有安装安全托盘的情况下，请勿在室内使用产品。

若要进行室外安装，请转至步骤9。

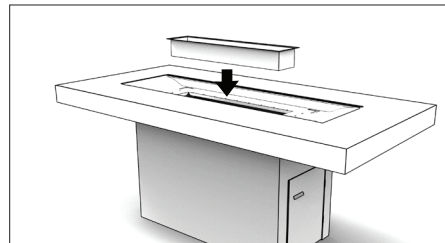

9. 将燃烧器放入金属托盘。

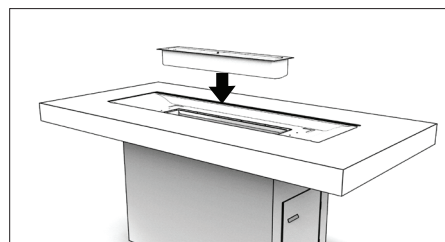

10. 放入挡风玻璃。(如适用)。

将每个玻璃幕墙标签与金属托盘上的指定槽对齐，然后轻轻放置到位。小心操作，以免打碎或损坏玻璃。

如果玻璃屏是标配零件（在美国是强制性的），则在未安装玻璃屏的情况下不得运行该设备。

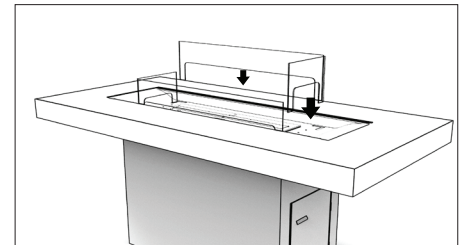

11. 在燃烧器周围摆放玻璃木炭石 - 小心挪动避免划伤燃烧器的表面。

请勿摆放玻璃木炭石在燃烧器的正上方或是会影响燃烧器正常运作的位置。

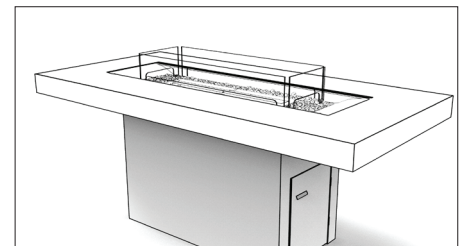

不要在桌子下方存放可燃液体。

注意：火炉燃烧时，桌面底座内不得存放其它物品。



壁炉安装（包含燃烧器）请根据安装操作手册。

Sicurezza Caminetti

Leggere il manuale di istruzioni per l'uso prima di operare un prodotto EcoSmart™ Fire.

FARE RIFERIMENTO AL MANUALE OPERAZIONI NELLA SCATOLA DEL BRUCIATORE PER DISTANZE MINIME E INSTALLAZIONE IN CASO DI UTILIZZO DI PROPANO O GAS NATURALE.

Quando si utilizza il bioetanolo come fonte di carburante, questo modello è adatto per uso interno ed esterno.

Prima dell'installazione assicurarsi che il modello sia posizionato in conformità con le distanze minime obbligatorie indicate di seguito.

Se viene in interni assicurarsi di prestare attenzione alle Dimensioni di Stanza Minime sottostanti:

| | |
|-------|---|
| XL900 | 110m ³ [3884ft ³] per bruciatore |
|-------|---|

ATTENZIONE: Assicurarsi che il fuoco sia posizionato lontano da materiali infiammabili e altre fonti di ignizione in ogni momento. Prestare molta attenzione a posizionare il fuoco lontano da oggetti che possono muoversi a causa di vento e correnti d'aria. Per esempio alberi / rami / carta e simili.

La base del bruciatore all'interno del modello non deve mai entrare in contatto diretto con materiali infiammabili.

Distanze laterali a mobili fissi e oggetti stabili che non sono soggetti a movimento come salotti o mobili da giardino devono rimanere un minimo di 600mm [23.6in] lontano dalla fiamma in ogni momento.

Distanze in eccesso verso oggetti suscettibili di movimento (ad es. Alberi) deve rimanere a una distanza minima di 2000mm [78.7in] dalla fiamma in ogni momento.

Questi prodotti sono dotati di piedi articolati regolabili in altezza a 360 °. Regolare i piedi ruotandoli in entrambe le direzioni fino a raggiungere un modello perfettamente livellato e stabile prima di operare.

L'acciaio inossidabile si arrugginisce o si corrode nel tempo se la contaminazione o i detriti non vengono puliti o rimossi immediatamente. Utilizzare sempre il coperchio del bruciatore incluso nel modello per evitare l'accumulo di polvere e detriti all'interno del bruciatore.

Se abitate in condizioni climatiche estreme dove è probabile che nevichi, è obbligatorio usare la Borsa Invernale per essere coperti dalla garanzia.

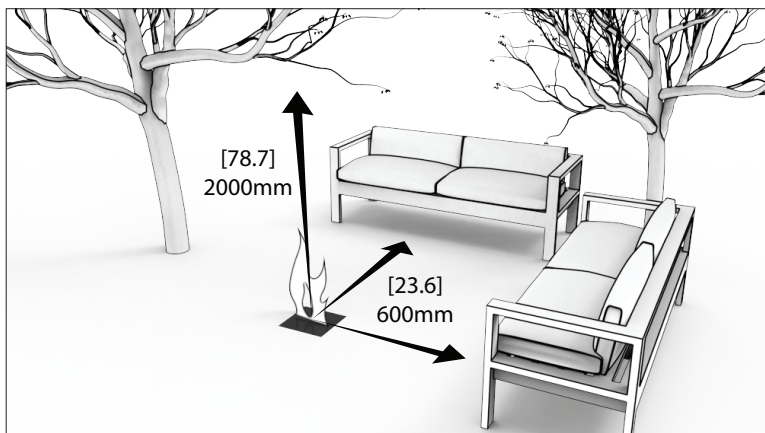

1. Distanze esterne

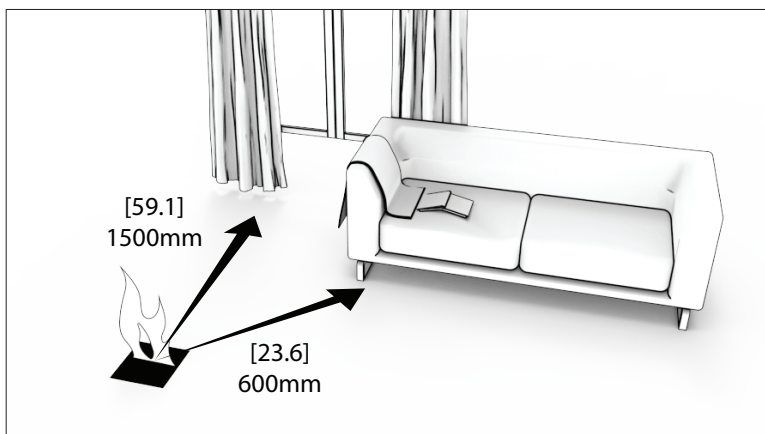

2. Distanza interna

Installazione Caminetti

1. Confermare di aver ricevuto tutte le parti necessarie come illustrato.

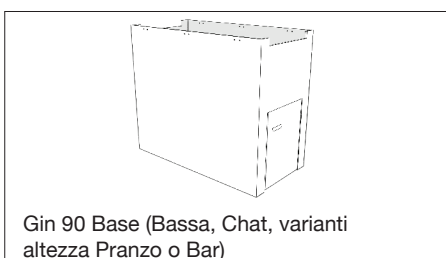
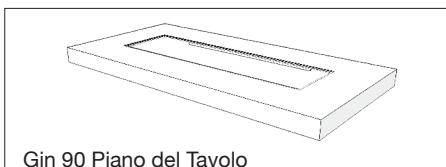
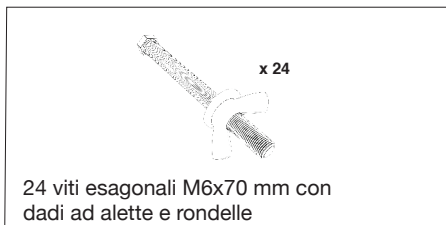

2. Questi modelli sono dotati di staffe di fissaggio (Ground Fixing Brackets) a terra in modo che possano essere installati in una posizione fissa. Seguire le istruzioni fornite con le staffe di fissaggio a terra per completare l'installazione del prodotto.

3. **NOTA:** le staffe di estensione dell'altezza sono disponibili come parte opzionale per sollevare il piano del tavolo di ulteriori 76 mm [3 pollici].

Se applicabile, seguire le istruzioni fornite con le Kit di sollevamento del tavolo prima di procedere con il passaggio 4.

4. Allineare attentamente il piano e la base del tavolo Gin. Assicurarsi che i 6 punti di fissaggio siano allineati.

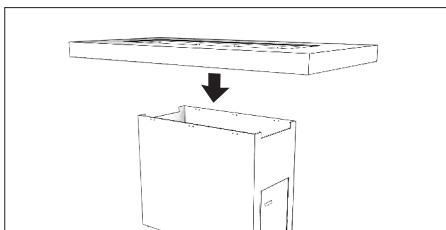

5. Disassemblare le serie di dadi e bulloni. Inserire i bulloni della flangia da sotto il piano del tavolo dove sono allineate le posizioni di fissaggio. Inserire il bullone con il filo rivolto verso l'interno.

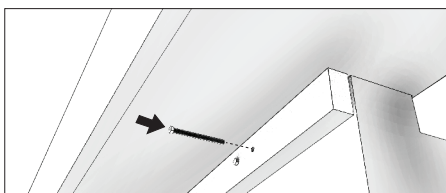

6. Una volta che i bulloni sono stati completamente spinti nelle loro posizioni di fissaggio, installare la rondella e saldare sicuramente usando il dado a farfalla.

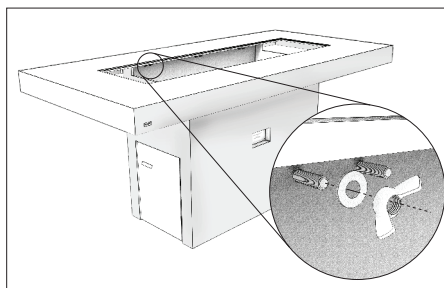

7. Inserire la vaschetta di metallo nella base.

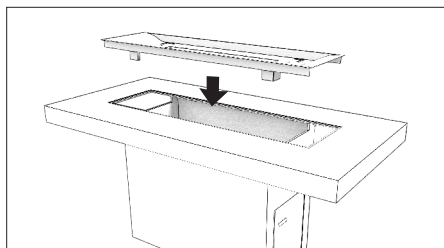

8. Per Installazioni (in località - please remove) interne inserire la Vaschetta di Sicurezza. L'apparecchio non deve essere utilizzato in località interne se non è stata installata la Vaschetta di Sicurezza.

Per installazioni all'aperto passare alla Fase 9.

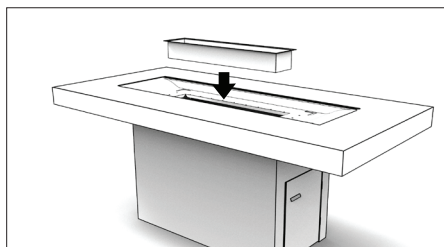

9. Inserire il Bruciatore nella vaschetta di metallo.

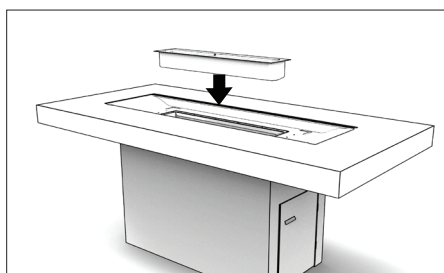

10. (Se applicabile) Inserire lo schermo.

Allineare ogni linguetta dello schermo di vetro con le apposite fessure nel vassoio in metallo. Esercitare pressione con cautela al fine di non rompere o danneggiare il vetro.

Se incluso come parte standard (obbligatorio negli USA), l'apparecchio non deve essere messo in funzione senza che lo schermo in vetro sia stato installato.

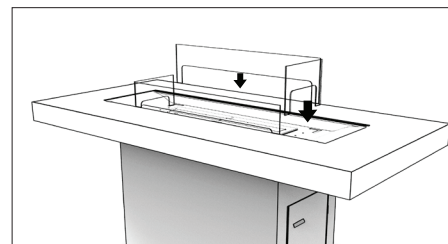

11. Aggiungere il carbone di vetro attorno al bruciatore - fare attenzione a non graffiare la superficie del bruciatore.

Non posizionare il carbone di vetro sul bruciatore o dove possono interferire con il funzionamento del bruciatore o della fiamma.

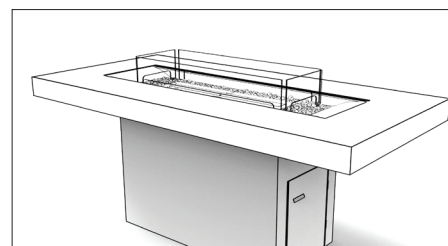

NON CONSERVARE LIQUIDO INFIAMMABILE SOTTO IL TAVOLO.

ATTENZIONE: Nessun altro oggetto deve venire conservato all'interno della cavità della Base del Tavolo mentre il fuoco è attivo.



OPERARE IL BRUCIATORE SECONDO IL MANUALE DI OPERAZIONE INCLUSO.

Distancias mínimas para las Chimeneas

Por favor, lea estas instrucciones y el manual de operaciones del quemador suministrado con el mismo completamente antes de hacerlos funcionar. Diríjase al manual de operaciones en la caja del quemador para distancias mínimas e instrucciones de instalación si se usa propano o gas natural.

Estos modelos están adecuados para uso en el exterior cuando se utiliza bioetanol como combustible.

Antes de la instalación asegúrese de que el modelo este posicionado de acuerdo con las distancias mínimas indicadas abajo.

Asegúrese de prestar atención a las medidas mínimas de habitaciones si utilizado en espacios interiores, a continuación:

| | |
|-------|---|
| XL900 | 110m ³ [3884ft ³] por quemador |
|-------|---|

PRECAUCIÓN: Asegúrese de que su chimenea esté situada lejos de materiales inflamables u otras fuentes de ignición en todo momento. Preste toda la atención al posicionamiento de la chimenea lejos de cosas que puedan moverse como resultado del viento o corrientes. Por ejemplo árboles/ramas/cortinas/papel y similares.

La base del quemador nunca debe entrar en contacto directo con materiales inflamables.

El espacio libre lateral entre la chimenea y mobiliario fijo o estable debe ser de al menos 600mm hasta la llama en todo momento.

El despeje o la distancia vertical entre la llama y cualquier objeto que sea susceptible a movimiento (árboles o plantas) tiene que ser un mínimo de 2000mm [78.7] en todo momento.

Estos productos incluyen pies articulados en 360° de altura ajustable. Ajuste estos pies girándolos en la dirección apropiada hasta obtener una posición nivelada y estable antes de hacerlos funcionar.

El acero inoxidable puede mostrar restos de corrosión con el tiempo si la contaminación o restos no son limpiados inmediatamente. Siempre utilice la tapa del quemador incluida con su modelo para evitar que se acumule polvo y escombros adentro del quemador.

Si vive en condiciones climáticas extremas donde es probable que se acumule nieve, es imprescindible utilizar el cubierta de invierno para estar cubierto por la garantía.

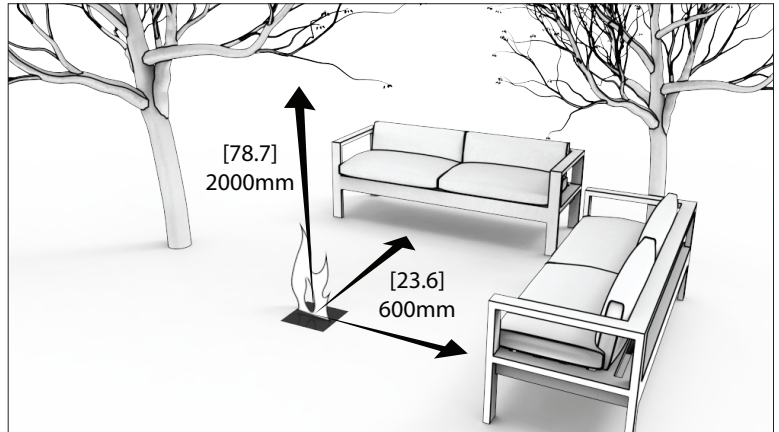

Espacio libre en exterior

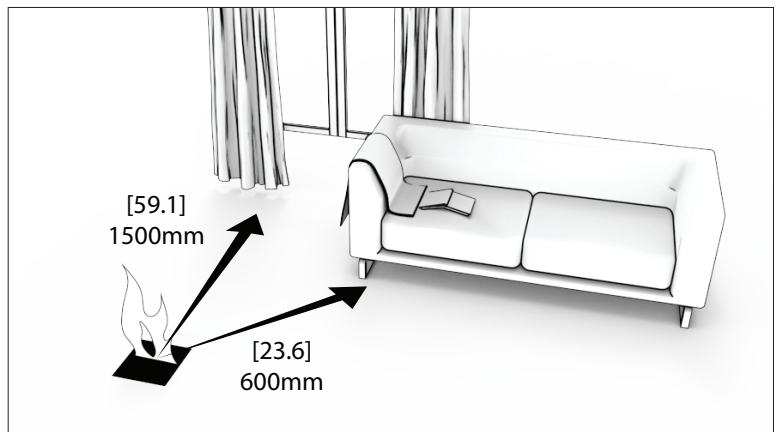

Espacio libre en interior

Instalación de la chimenea

1. Confirme que ha recibido todas las piezas necesarias según la ilustración.

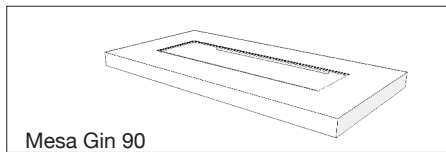
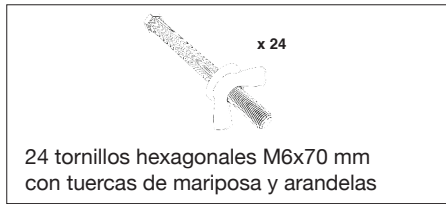

2. Estos modelos vienen con soportes de fijación de tierra para que puedan instalarse en una posición fija. Siga las instrucciones suministradas con los soportes de fijación de tierra para completar la instalación del producto.

3. NOTA: Los soportes de extensión de altura están disponibles como pieza opcional para levantar la superficie de la mesa de unos 76 mm [3 pulgadas] adicionales.

Siga las instrucciones, si es aplicable, incluidas con los Kit de elevación de mesa antes de continuar con el paso 4.

4. Alinee cuidadosamente la base de la mesa Gin top. Asegúrese de que los 6 puntos de fijación estén alineados.

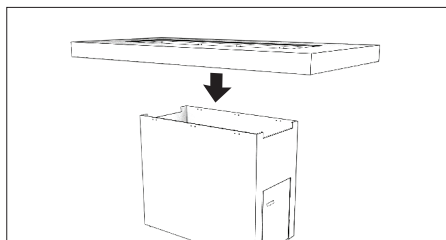

5. Desmonte los juegos de tuercas y tornillos. Inserte los pernos de la brida desde debajo de la mesa donde se alinean las posiciones de fijación. Inserte el perno con la rosca hacia adentro.

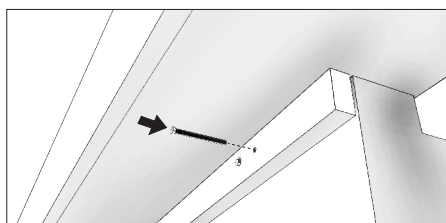

6. Una vez que los pernos se hayan empujado completamente a través de sus posiciones de fijación, instale la arandela y fjela firmemente con la tuerca de mariposa.

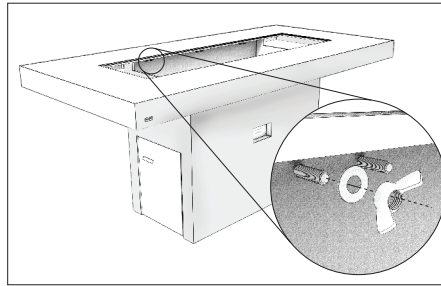

7. Inserte la bandeja de metal en la base.

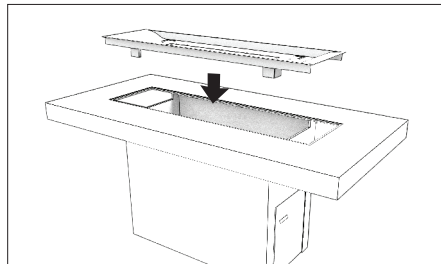

8. Inserte el doble fondo de seguridad para instalaciones interiores. El aparato no debe estar utilizado en espacios interiores sin el doble fondo de seguridad instalado.

Para la instalación en el exterior, vaya al Paso 9.

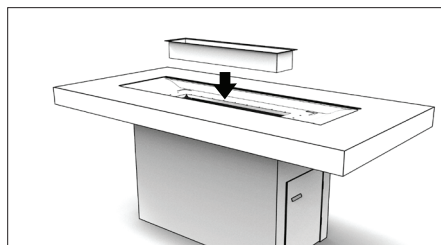

9. Inserte el quemador en la bandeja de metal.

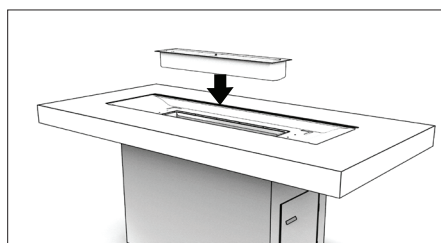

10. Inserte la pantalla de vidrio. (Si se aplica).

Alinee cada pestaña de la pantalla de vidrio con las ranuras designadas en la bandeja de metal, coloque suavemente en su posición. Tenga precaución para no fracturar o dañar el vidrio.

Si se incluye como pieza estándar (obligatorio en EE. UU.), el aparato no debe utilizarse sin la pantalla de cristal instalada.

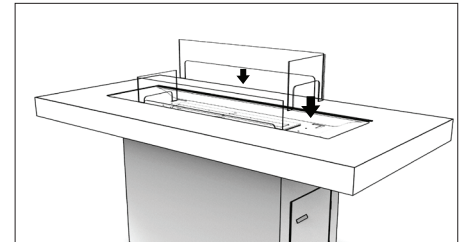

11. Añade el vidrio antracita alrededor del quemado - Precaución de no rasgar la superficie del quemador

No coloque ningún vidrio antracita sobre el quemador. Esto puede causar interferencia con la llama y/o el uso apropiado del quemador.

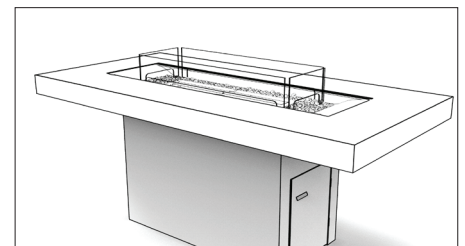

NO ALMACENE EL LÍQUIDO INFLAMABLE BAJO LA MESA.

PRECAUCIÓN: Ningún otro artículo debe almacenarse dentro de la cavidad de la base de la mesa mientras el fuego está en funcionamiento.



SIEMPRE USE DE ACUERDO CON EL MANUAL OPERACIONAL, INCLUIDO CON EL QUEMADOR.



MAD Design Group

Showrooms 3 & 4, 40-42 O'Riordan Street

Alexandria NSW 2015 Australia

Tel: +61 2 9997 3050 Email: info@maddesigngroup.com

REV1120

CLEARANCES & INSTALLATION MANUAL PROPANE & NATURAL GAS

Please read these instructions and the Burner Operations Manual provided with your burner completely before operating the appliance.

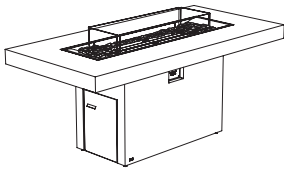

Gin 90 Bar
Concrete 180.5kg, 397.1lbs
Teak 133kg, 292.6lbs

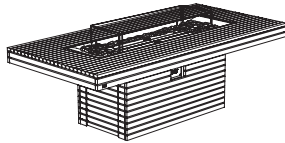

Gin 90 Dining
Concrete 172.5kg, 379.5lbs
Teak 128kg, 281.6lbs

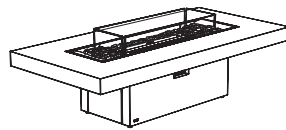

Gin 90 Chat
Concrete 162.5kg, 357.5lbs
Teak 119kg, 261.8lbs

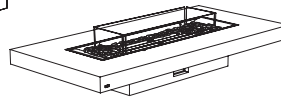

Gin 90 Low
Concrete 154.5kg, 339.9lbs
Teak 100kg, 220lbs

Fireplace Clearances

When planning an appliance installation, it's necessary to determine the following information first:

Environmental Conditions

WARNING: Ensure that your fire is positioned away from flammable materials and other sources of ignition (combustible materials, gasoline and other flammable vapors and liquids) at all times. Pay very close attention to positioning the fire away from items that may move as a result of wind and drafts. For example trees/branches/curtains/paper and the like.

The base of the burner within the model must never come into direct contact with flammable materials.

If you live in extreme weather conditions where accumulation of snow is likely, use of the Winter Bag is imperative in order to be covered by the warranty.

Locating your appliance

Adequate and constant ventilation is important to keep the appliance functioning properly and safely, including ventilation of the appliance undersides. Setting the appliance without air circulation underneath can cause heat build up and improper combustion. Do not remove the feet or operate the appliance with missing feet.

1. Locate the appliance on hard, flat surface that extends the full length and width of the appliance. The appliance and the LP tank cover can be placed on combustible surface (such as wood deck) or on non-combustible material (such as concrete). Ensure all clearances to the sides and clearances above the appliance are observed at all times (see figures 1 and 2).
2. Maintain a minimum air space of ½" (12.5mm) between the ground surface and the underside of the appliance sidewalls by adjusting the articulating feet up or down as necessary.
3. Do not place the appliance over grass, artificial turf, carpet or any uneven surface, as this will block the airflow underneath the appliance. See figure 1.
4. Follow the same instructions above for the LP tank cover (if purchased). See figure 1.

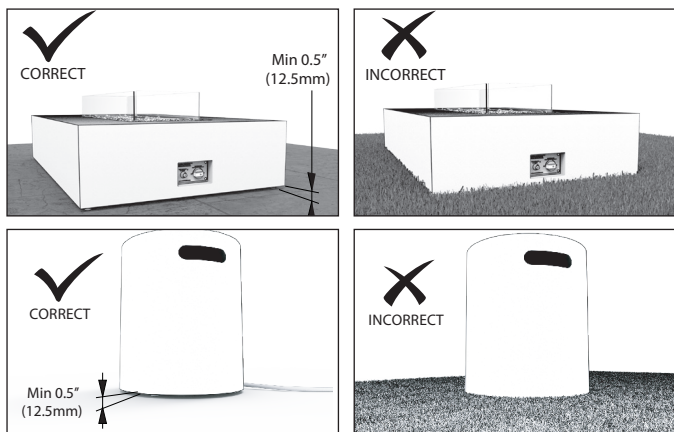

Figure 1

Position the appliance adjacent to the gas supply line or LP gas supply cylinder.

DO NOT locate the appliance where it will get excessively wet or submerged in water.

Minimum Clearances

Note: Measurements are distances closest to the flame

Side clearances to fixed and stable furniture items that are not susceptible to movement such as lounges or patio furniture must remain a minimum of 24in (610mm) away from the flame at all times.

Overhead clearances to items that are susceptible to movement (e.g. Curtains/Trees) must remain a minimum of:
- 78.7in (2000mm) away from the flame at all times.



Ceiling clearances must remain a minimum of:
- 72in (1,829mm) to overhang from top of burner.



Please note that:

Any furniture items or fittings directly above or beside the Burner installation must be deemed suitable for heat tolerances by their manufacturer e.g. electronic items including screens and entertainment equipment, wallpaper, laminates, veneers, glues and reconstituted materials.

MAD Design USA is not liable for any injuries or damages sustained through any installation not in compliance with this manual.

A fire extinguisher is strongly recommended.

| | |
|---|--|
|  WARNING  | |
|  | MAD Design USA disclaims any responsibility for, and the warranty will be voided by, the following actions: |
| | <ul style="list-style-type: none"> • Installation and use of any damaged components. • Modification of the burner assembly or burner orifice. • Installation other than as instructed in this manual. |
| Any such action may cause a fire hazard | |

| | |
|---|--|
|  WARNING  | |
|  | Fire Risk Provide adequate clearance: |
| | <ul style="list-style-type: none"> • Around air openings • For service access Locate appliance away from traffic areas |

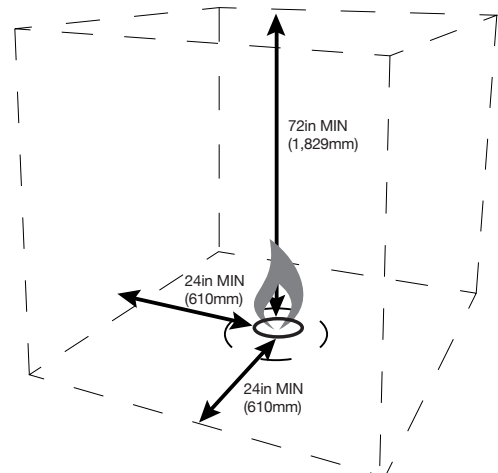
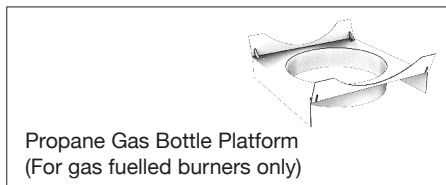
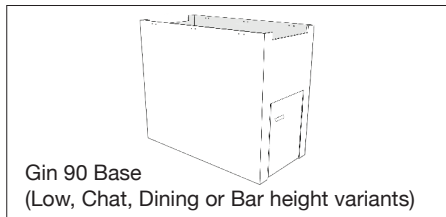
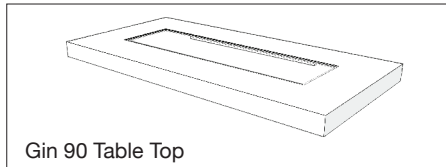
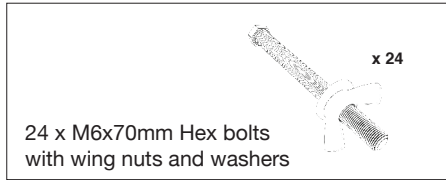

Figure 2

Clearance measurements are distances from the edge of the flame, not from the centre.

Fireplace Installation

1. Confirm you have received all necessary parts as illustrated.



2. These models come with Ground Fixing Brackets so they can be installed in a fixed position. Follow the instructions supplied with the Ground Fixing Brackets to complete the installation of the product.

3. NOTE: Height extension brackets are available as an optional part to lift your table top by an additional 76mm [3in].

If applicable, follow the instructions supplied in the Lift Kit before proceeding with step 4.

4. Carefully align the Gin 90 top and table base. Ensure the 6 fixing points are aligned.

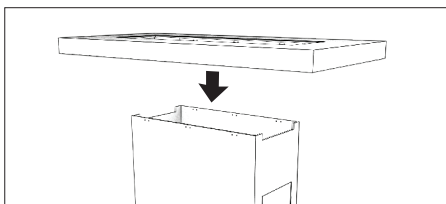

5. Disassemble the nut and bolt sets. Insert the flange bolts from the underneath of the table top where the fixing positions are aligned. Insert the bolt with the thread facing inwards.

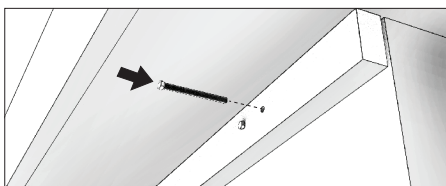

6. Once the bolts have been fully pushed through its fixing positions, install the washer and secure tightly using the wing nut.

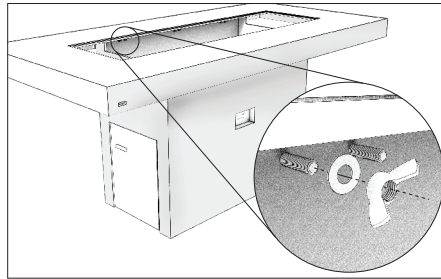

7. Insert the metal tray into the base.

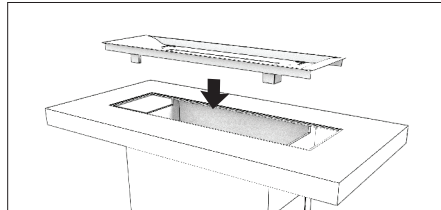

8. Insert burner into metal tray. Please read assembly instructions in the Operations Manual provided with your burner.

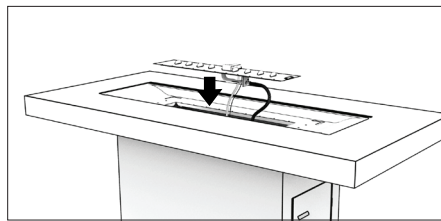

9. Insert Glass Screen (If applicable). Align each glass screen tab with the designated slots in the metal tray, gently put into position. Exercise caution so as not to fracture or damage glass. If included as a standard part (compulsory in the USA), the appliance must not be operated without the glass screen installed.

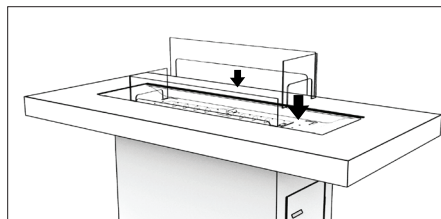

10. Fill the burner area with the included black glass media. Use all black glass charcoal provided for best effect. Keep clear of the sparker to avoid accidental blockage. Spread the media evenly while ensuring the burner is completely covered.

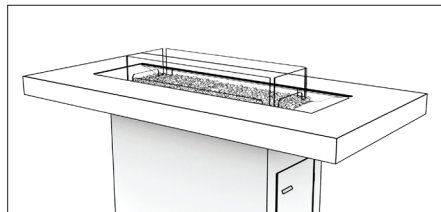

IF USING PROPANE GAS BOTTLE

Gin 90 Chat, Dining and Bar Tables are the only models suitable for storing the gas bottle within the table base.

Gin 90 Chat: A horizontal propane bottle is required. Turn the propane platform 90° and rest the bottle on the holding tabs.

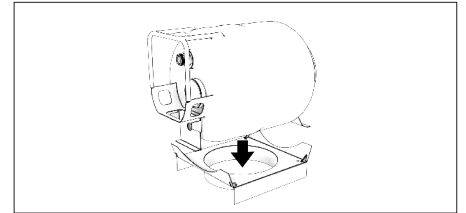

Gin 90 Dining and Gin 90 Bar: Place the gas bottle onto the propane gas bottle platform in the upright position.

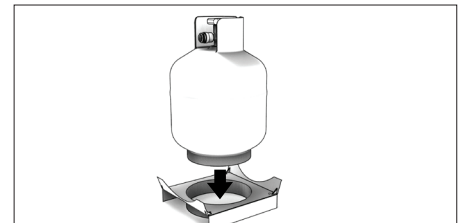

Attach gas supply hose to the Propane bottle.

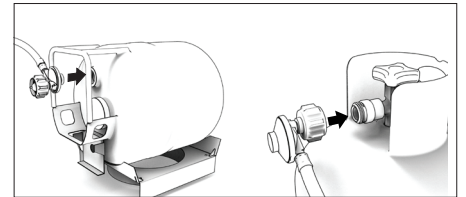

Ensure the Propane Gas Bottle Platform assembly is in the correct orientation. Carefully push the assembly into the cavity within the Table Base. Close the door once in position.

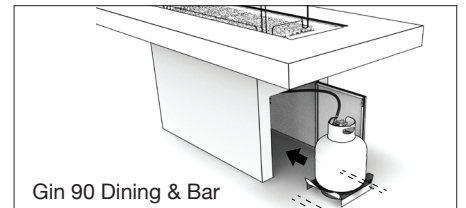
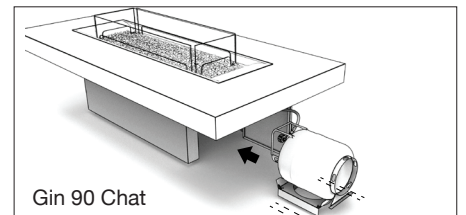

CAUTION: No other items should be stored within the Table Base cavity while the fire is in operation.

OPERATE ACCORDING TO THE BURNER OPERATIONS MANUAL INCLUDED WITH THE BURNER.



MAD Design Group

Showrooms 3 & 4, 40-42 O'Riordan Street

Alexandria NSW 2015 Australia

Tel: +61 2 9997 3050 Email: info@maddesigngroup.com

REV1120