

www.somfy.com

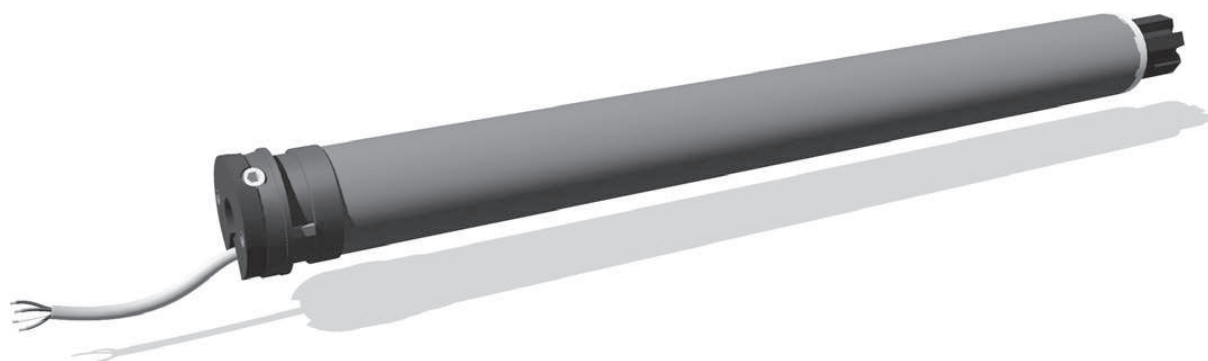

Sonesse[®] 40 PA



Ref: 5064822A

HOME
MOTION BY

somfy[®]



EN**Installation instructions****page 2**

SOMFY hereby declares that this product complies with the essential requirements and other relevant provisions of Directive 1999/5/EC. A Declaration of Conformity is available at the web address www.somfy.com/CE. Suitable for use in EU, CH and NO

EN**FR****Notice d'installation****page 8**

Par la présente, Somfy déclare que l'appareil est conforme aux exigences essentielles et aux autres dispositions pertinentes de la directive 1999/5/CE. Une déclaration de conformité est mise à disposition à l'adresse internet www.somfy.com/ce. Utilisable en UE CH et NO.

FR**IT****Guida di installazione****pag. 14**

Somfy dichiara che questo dispositivo è conforme ai requisiti essenziali e alle altre disposizioni pertinenti della Direttiva 1999/5/CE. Una dichiarazione di conformità è disponibile all'indirizzo Internet www.somfy.com/ce.

IT**ES****Guía de instalación****página 20**

Por la presente, Somfy declara que el aparato cumple las exigencias esenciales y el resto de disposiciones pertinentes de la directiva 1999/5/CE. Podrá encontrar una declaración de conformidad en la página web www.somfy.com/ce.

ES

CONTENT

1 Introduction

2 Safety

2.1 General information

2.2 General safety advice

3 Installation

4 Commissioning

4.1 Checking the rotation direction

4.2 Adjusting the end limits

5 Use

6 Troubleshooting

7 Technical data

8 Environment

1 Introduction

Product Description

The Sonesse® 40 is a motor specially dedicated to interior applications. The Sonesse® 40 motor range can motorize all interior applications: Roller shades, Venetian blinds, Roman shades, Pleated & cellular shades, Projection screens. The Sonesse® 40 is designed to ensure quiet operations.

Warning: The Sonesse® 40 isn't compatible with wind functions.

2 Safety

2.1 General information

- This Somfy product must be installed by a professional motorisation and home automation installer, for whom these instructions are intended.
- Before installation, check that this product is compatible with the associated equipment and accessories.
- These instructions describe how to install, commission and use this product.
- Moreover, the installer must comply with current standards and legislation in the country in which the product is being installed, and inform his customers of the operating and maintenance conditions for the product.
- Any use outside the sphere of application specified by Somfy is not approved. Such use, or any failure to comply with the instructions given herein will invalidate the warranty, and Somfy refuses to accept liability.

2.2 Specific safety advice

The safety instructions that must be observed, besides the usual rules, are explained in these instructions and in the attached «Safety Instructions» document.

Never immerse the motor in liquid!



Avoid impacts!



Never drill holes in the motor!



Do not drop it!



3 Installation

Motor preparation

- 1) Fit the crown (a) and drive wheel (b) to the motor.
- 2) Measure the length (L) between the end of the drive wheel and the head end.

Tube preparation

- 1) Cut the tube to the required length.
 - 2) Deburr the tube and remove the debris.
- For smooth roller tubes, cut a notch with the following measurements: $e = 7 \text{ mm}$ $h = 10 \text{ mm}$

Motor/tube assembly

- 1) Slide the motor into the tube.
- For smooth roller tubes, position the notch previously cut on the crown.
- 2) Fix the tube to the motor with self-tapping screws or steel pop rivets depending on the dimension ($L - 5 \text{ mm}$).

Mounting the motorized tube on the brackets

If necessary, screw the bracket interface on the motor head.

- 1) Mount the motorized tube on the end bracket (c).
- 2) Mount the motorized tube on the motor bracket (d).

Wiring

- 1) Switch off the power supply.
- 2) Connect the motor according to the information in the table below.

RANGE	1 Neutral	2 Live	3 Live	4 Earth
230V-50Hz	Blue	Brown	Black	NA
120V 60Hz	White	Black	Red	Green
220V 60Hz	Blue	Brown	Black	NA
110V 50/60Hz	White	Black	Red	NA

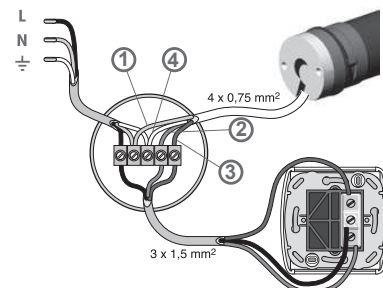
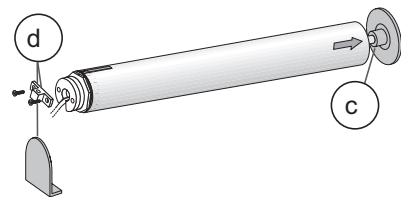
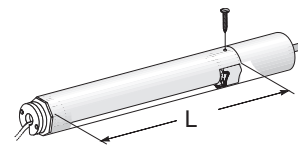
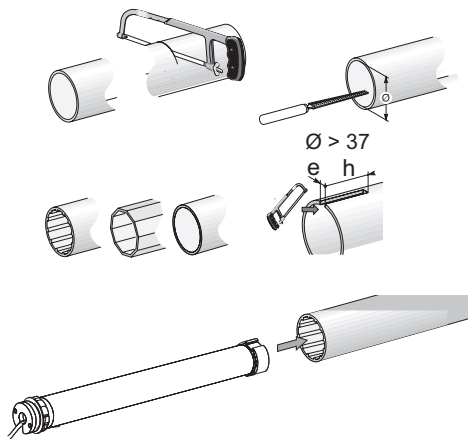
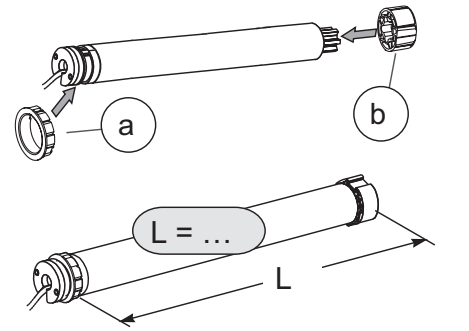

4 Commissioning

4.1 Checking the rotation direction

Switch on the power supply.

- 1) Press the control point UP button:
 - a) If the shade is raised (a), the rotation direction is correct: move to the section entitled «Adjusting the end limits».
 - b) If the shade is lowered (b), the rotation direction is incorrect: move to the next step.

2) Switch off the power supply.
Reverse the two live wires on the control point.

3) Switch on the power supply.
Press the control point UP button
to check the rotation direction.

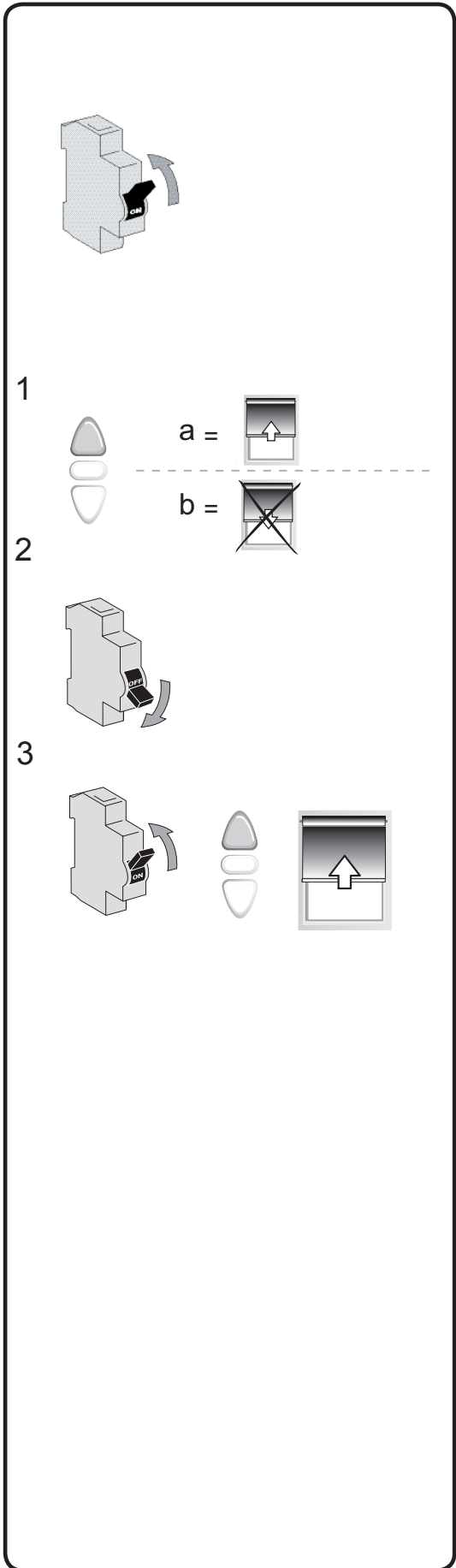

4.2 Adjusting the end limits

The limits can be set in any sequence.

1) Up limit

Press the control point UP button to raise the shade to the Up limit and turn the corresponding adjustment screw to set this limit.

2) Down limit

Press the control point DOWN button to lower the shade to the Down limit and turn the corresponding adjustment screw to set this limit.

5 Use

Up, Down & Stop

- 1) To move the shade from a limit to the other limit, press briefly the UP or DOWN button.
- 2) To stop the shade, press the STOP button.

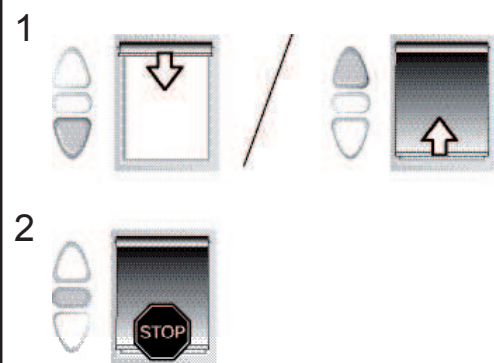
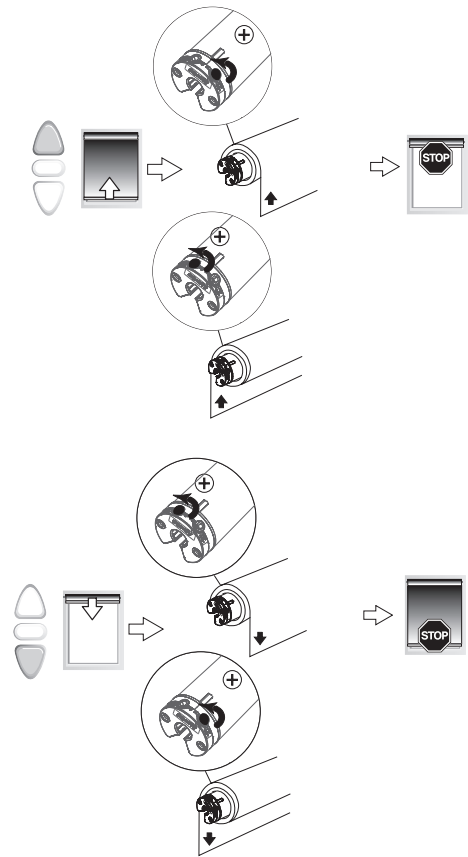

6 Troubleshooting

The motor doesn't work:

Verify:

- The wiring of the motor.
- The power supply specifications.
- The heat generated (wait for the cooling of the motor).

The equipment stops too soon:

Verify:

- The operation of end-limits during the rotation of the motor.
- The crown is properly fitted to the tube.
- The end-limits of the motor are properly adjusted.
- That the shade is within the recommended weight limit.

The equipment is noisy:

Verify that:

- The wheel and the crown are well adapted to the used tube.
- The mechanical plays between motor, accessories, tube and end of tube must be decreased to the maximum.
- The wheel is properly fixed to the tube.
- The equipment is not constrained between the brackets.
- The length of the notch is adapted to the motor hook or to the used crown.
- Debris, screws or other are not in your tube.
- The power supply specifications.
- The temperature of the environment is in conformity with the operating temperature.

7 Technical data

Power supply	230V/50Hz - 120V/60Hz - 220V/60Hz - 110V 50/60Hz
Operating temperature	0°C / 60 °C
Protection rating	IP 44

8 Environment



Damaged electric products and batteries should not be disposed of with normal household waste.

Make sure to drop them in specially provided containers or at an authorized organization that will ensure they are recycled