

PRO 20 DO PRO 50 DO User's Manual

DIGITAL BIRD INCUBATOR
Model : PX-20DO / PX-50DO

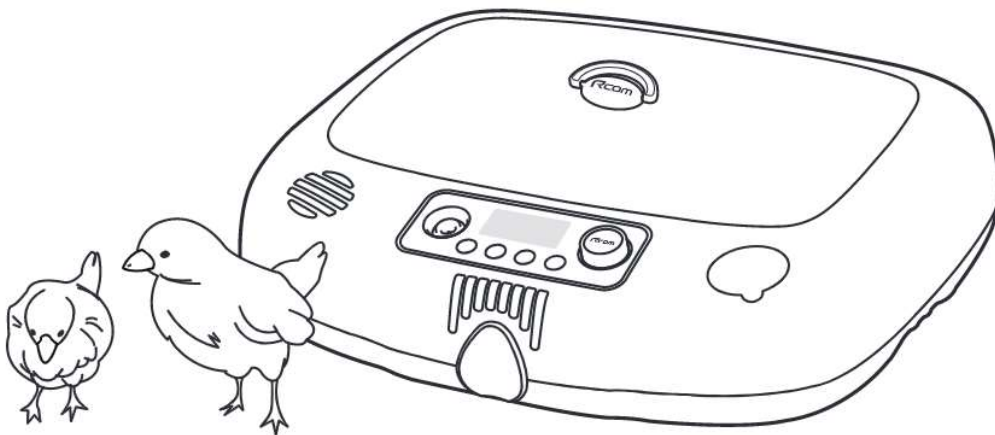

This manual is produced for common use and may contain images or contents different from the purchased product. In addition, to improve the performance of the product, specifications are subject to change without prior notice.

Rcom



PRO 20 DO
VIDEO MANUAL



PRO 50 DO
VIDEO MANUAL

Contents

How to use Rcom PRO 20 DO, PRO 50 DO

1. Introduction	
(1) Rcom PRO 20 DO, PRO 50 DO Introduction	3 ~ 9
(2) Safety precautions	
(3) Name of each part and basic components	
(4) Names and functions of operational parts	
2. Before use	
(1) How to Assemble the Incubator / Egg-turning plate	10 ~ 13
(2) What is Incubation room?	
(3) Preparation of incubation	
3. Function Settings	
(1) Incubation modes	14 ~ 24
(2) Incubation start with automatic mode	
(3) Incubation start with manual mode	
(4) Incubation start for other birds	(11) How to set the dry mode
(5) Incubation condition reset during Incubation	(12) How to setup abnormal High/Low temperature alarm
(6) How to set turn ON/OFF humidification function	(13) How to change Celsius/Fahrenheit
(7) How to set egg turning test, egg turning check	(14) How to turn the backlight ON/OFF/EVENT ON
(8) Candling	(15) How to ON/OFF sound
(9) Alarm for water supplement	(16) Return to factory settings
(10) Power failure alarm function	(17) How to terminate incubation
4. Incubation	
(1) Humidity and ventilation control during incubation / Management after incubation / Dew condensation	25
5. How to separate and clean	
(1) How to separate and clean	26 ~ 27
6. Product Information	
(1) FAQ	28 ~ 31
(2) Troubleshooting and measures	
(3) Specification / Guide to Consumer Damage Compensation	

⚠ The success of incubation may vary according to different factors. The manufacturer and distributor are not responsible for failure of incubation of costly eggs, loss of life, property damage due to negligence of user, remodeling, painting, modification of purpose of use or power failure. When incubating parrot or costly birds please verify the internal temperature (adjust) before use. Please read carefully the instruction manual before use to avoid failures.

Mark explanation



CAUTION: caution mark for mistakes that can cause loss of animal life, property damage, or product breakdown or damage.



Prohibited



Do not disassemble



It is necessary to keep



Remove the power cord from the outlet.

Tip : References or useful suggestions in using Rcom product.

● Rcom PRO 20 DO, PRO 50 DO

We sincerely thank you for purchasing our Rcom incubator. Rcom incubator provides optimum incubation conditions based on the know-how and integrated technology of AUTOELEX by controlling the environment with AI. However, the user's incubation knowledge and proper operation are very important for the best hatching result. Users need to carefully observe and adjust all incubation conditions such as species of eggs, temperature and humidity for each incubation period, and the hatching room conditions. We sincerely suggest you carefully read the instructions before use to allow for the successful incubation and proper use of the device.

● Features of Rcom PRO 20 DO, PRO 50 DO

**Rcom PRO 20 DO: 20 eggs capacity for chicken egg size (52 quail egg size, 10 goose egg size)
Rcom PRO 50 DO: 48 eggs capacity for chicken egg size (116 quail egg size , 24 goose egg size)**

[Main Functions]

- * Jog dial for optimized user interface
- * Automatic temperature, humidity control and setting
- * Automatic egg turning and stop function
- * Micro chip with optimum incubation conditions according to the species of birds, for incubation beginners
- * Manual setting Mode for incubation specialists
- * LCD egg turning
- * Integrated candling function
- * Main body drying function
- * Anti-bacterial humidification unit
- * Double-glazed view window to minimize the influence of outside temperature
- * Optimal air circulation technology

[Easy Function]

- * LED ambient light changing its color by the device status
- * Water supplement alarm function
- * Trays for small(quail eggs), standard(chicken eggs), and large(goose eggs)
- * Universal tray for various size of eggs - sold separately
- * Alarm function for abnormal temperature (high and low temperature) for sudden external temperature change
- * One-touch body locking device
- * Detachable top and bottom for easy cleaning after hatching
- * Low-noise stepping egg turning motor
- * Easily replaceable built-in control box
- * A handy handle for easy opening and closing of the window

[Other Functions]

- * Retaining hatching data during power failure. Notification of power failure
- * Anti-skid egg-turning plate for preventing leg deformities in newborn birds
- * °C(Celsius) and °F(Fahrenheit) convertible

● Electrical hazards

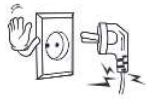

! Do not use a damaged power cord or loose outlet. Risk of electric shock or fire.

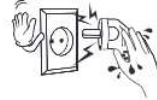

! Do not pull the cord when taking out the power cord, and keep wet hands away from connecting plug. Risk of electric shock or fire.



⊘ Never unplug when using the unit. Operation interruption may result in loss of life inside the unit.



! Do not twist or crush electric cord. Risk of electric shock or fire.



! Do not insert multiple connecting plugs in an outlet. Risk of fire or electrical overload.



! If the machine will be stored for a long time, please clean it before and after storage. Accumulated dust can pose a fire or shock risk.

● Installation, use related precautions



! Do not put a person in the product. He/she may be hurt or killed.



! Do not turn off the power while your pet is in the device. It may be hurt or killed.



! Do not install in dusty or dirty places. Dust or foreign matter may cause electric shock or fire.



! Do not install the product in direct sunlight. There is a possibility of discoloration of the case and rapid temperature rise may cause death of the animal.



! Do not install in wet or humid places. There is a risk of electric shock or fire if water gets inside.



! Avoid places that are too cold or hot and do not place fire or heat machines near the product. There is a risk of fire.



! Do not place the power cord near sources of heat. The coating on the cord may melt and cause fire or electric shock.



! Please install it firmly when installing on cabinet or shelf. Falling or a fall of the product may cause malfunction and serious injury.



! Do not place the product upside down. The product may be damaged.



! Do not allow children to climb on the product. A fall of the product may cause injury or death.



⊘ Never disassemble, repair or modify the product as you please. It may cause electric shock and fire. If you need repair, please contact a service center.



! Be careful not to let foreign substances into the external hole of the product. It may cause electric shock, fire, and physical injury.



! If any unusual sounds or smoke appear on the product, unplug it immediately and contact a service center. It may cause electric shock or fire.



! Do not cover the ventilating opening. Inner temperature can rise, interrupting incubation.



! If you drop it or the case is broken, disconnect the power plug and contact the service center. Using as it is may cause electric shock or fire.

● Cleaning related precautions



! Do not spray cleaning chemicals directly onto the interior or exterior of the product. Spraying directly may increase the possibility of discoloration, cracking, peeling of the printed surface.



! Clean the incubator by a soft cloth with a neutral detergent.



! Wipe the dust on the power plug's pins and contacts with a dry cloth. It may cause electric shock or fire.



! When cleaning, be sure to remove the power cord and clean it with a soft cloth. Do not use chemicals such as wax, benzene, alcohol, thinner or lubricant etc.



! After cleaning, wipe off the water and activate the dry function to remove the water completely from the incubator before storage.
[How to set the dry mode: see page 24]



! At least once a year, please contact our service center or customer service center to check the machine. Failure to clean dust inside the product for a long period of time may cause fire or malfunction.

1. Introduction







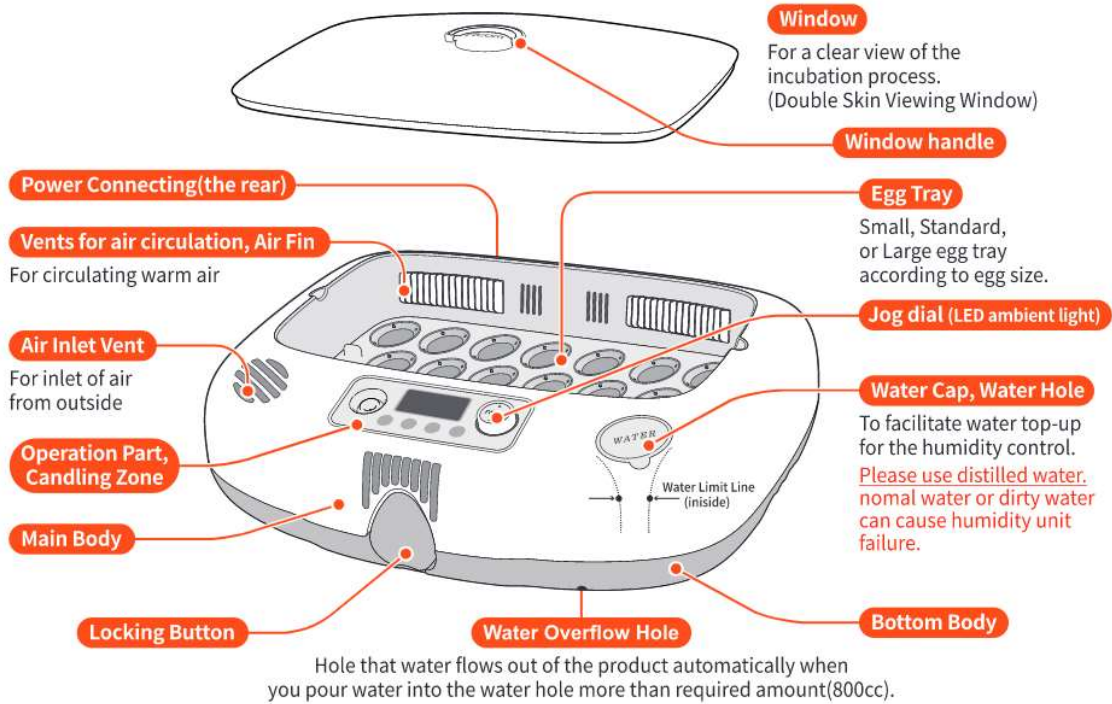





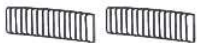

(3) Name of each part and basic components

● Rcom PRO 20 DO Name of each part

The serial number is on the back of the product. Product serial number (example: H20MX0000000000). If the serial number is damaged, customer service is not available for the product.



● Basic components

				 * The Air Fin will be provided and attached to the main body(upper)
Main body	Bottom body	Window	Egg-turning plate	20 Air fin(2EA)
				
Small egg tray	Standard egg tray	Large egg tray	Power cord	Manual
	 ※ Rolling divider 10EA	 ※ Divider 10EA	 How to replace it	
Brooding tray (Sold separately)	Rolling divider SET (Sold separately)	Universal tray SET (Sold separately)	Humidity Unit (Sold separately)	

1. Introduction

(3) Name of each part and basic components

● Rcom PRO 50 DO Name of each part

The serial number is on the back of the product. Product serial number (example: H50MX0000000000).
If the serial number is damaged, customer service is not available for the product.

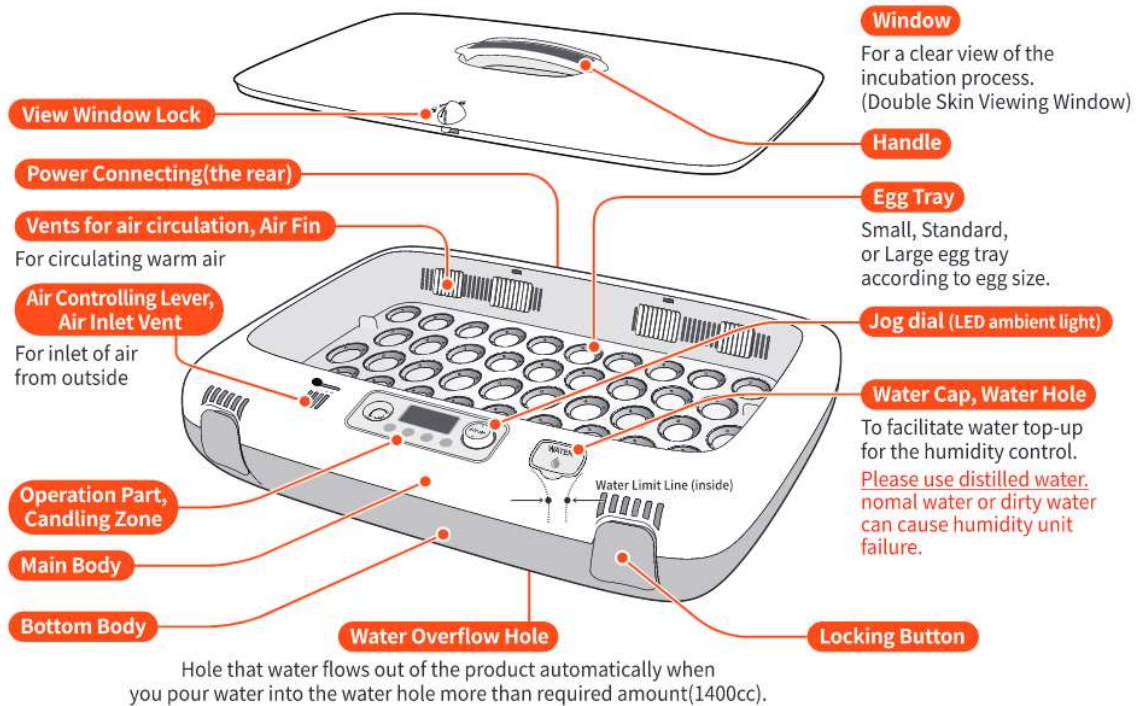

● Basic components

Main body	Bottom body	Window	Egg-turning plate	Manual
9 section x 2 pieces 7 section x 2 pieces (It will be provided in the assembled. Please do not change its position and direction.)	50 Air fin(4EA)	Small egg tray	Standard egg tray	Large egg tray
Power cord	Universal tray SET (Sold separately) ※ Divider 10EA	Humidity Unit (Sold separately)	How to replace it	

● Names and functions of operational parts

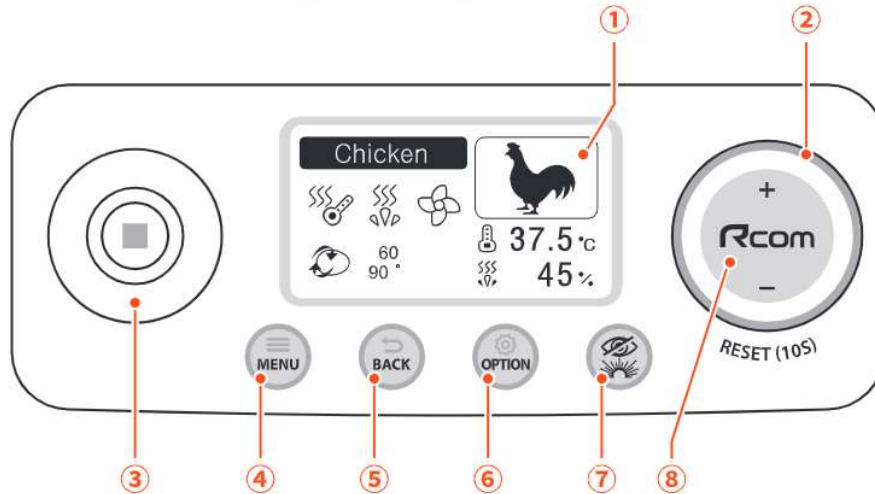













- ① **Display** : Current condition is shown.
- ② **LED ambient light** : Displays the machine status in color.
 - Blinking blue (Before starting incubation or after finished incubation)
 - White (Start, early and middle stages of hatching)
 - Yellow (Final stage of hatching)
 - Green : (Other settings)
 - Blinking red (Abnormal occurrence)
- ③ **Candling zone** : Press the Test button for 1 second to use it as an egg inspection machine.
- ④ **MENU button** : Enter menu.
- ⑤ **BACK button** : Use to terminate incubation or return to the previous step.
- ⑥ **OPTION button** : Enter option menu.
- ⑦ **CANDLING button** : Press and hold for 1 second to turn on the LED light in the candling zone.
- ⑧ **Jog dial** : Turn left or right to use it.
 - During the incubation, it starts egg-turning for once if you turn the jog dial left or right.
 - Press and hold for 1 second to check the set temperature and humidity.
 - Press and hold for 10 seconds for factory initialization.











ICON	FUNCTION	ICON	FUNCTION
<p>Bird Icon Display</p>	<p>**Choose a kind**</p> <ul style="list-style-type: none"> * Chicken * Duck * Quail * Pheasant * Peafowl * Goose * wildgoose * G-Pheasant * Turkey * Others Birds 		<p>Egg turning indication</p>
			<p>Manual egg turning stop indication</p>
			<p>Automatic egg turning stop indication</p>
			<p>Incubation termination</p>

1. Introduction

(4) Names and functions of operational parts

Chicken	Species of birds		FAN operation display
 37.5℃	 Current temperature display / Temperature abnormal display	 	Heater stop display / Heater operation display
 45%	OFF Current humidity display / Humidification function OFF	 	Humidification stop display / Humidification operation display
60	90° Egg turning interval indication / Egg turning angle indication	 	Water supplement / Humidity abnormal
	Cooling function display		Power failure notification

● Option function

Dry		Set the drying time to remove the moisture remaining inside before incubation terminate. [Default : OFF]
T.CAL (Temperature calibration)		 WARNING Fatal Damage with Incorrect Calibration!  Be sure to read CAUTIONS. We do not recommend customers to recalibrate by their own. If you need to recalibrate, please ask purchase place.
H.CAL (Humidity calibration)		 WARNING Fatal Damage with Incorrect Calibration!  Be sure to read CAUTIONS. We do not recommend customers to recalibrate by their own. If you need to recalibrate, please ask purchase place.
ALARM (Abnormal high alarm)	High Temp	Alarm sounds when incubator temp. is higher than setting value because of room temp. change or heating system disorder Setting range : 0.0°C ~ 5.0°C [Default : 2.0°C (2.0°F)]
ALARM (Abnormal low alarm)	Low Temp	Alarm sounds when incubator temp. is lower than setting value because of room temp. change or heating system disorder Setting range : 0.0°C ~ -5.0°C [Default : -3.0°C (-3.0°F)]
Unit		Selecting Centigrade °C , and Fahrenheit °F [Default Centigrade °C]
Light		LCD Backlight management setting * Always On : Always backlight On * Always Off : Always backlight Off * Event On : 20 Sec. ON with key input [Default : Always On]
Sound		ON/OFF Setting for melody, other alarms [Default : ON]
Info		Basic information of Incubator (version Indication)

2. Before use

(1) How to Assemble the Incubator / Egg-turning plate

● Rcom PRO 20 DO

5 Window



4 Standard egg tray

* Can equip only one tray



3 Main body

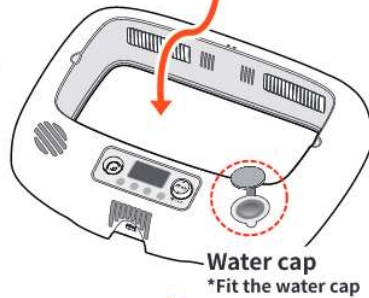

Water cap
*Fit the water cap

2 Egg-turning plate

*Attention of the direction

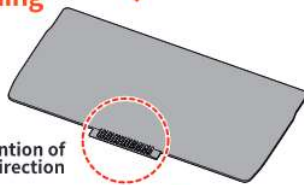

1 Bottom body

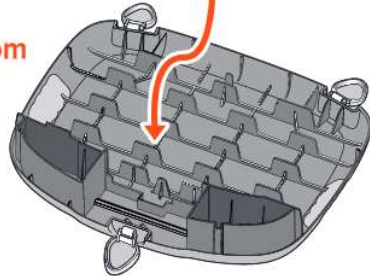

6

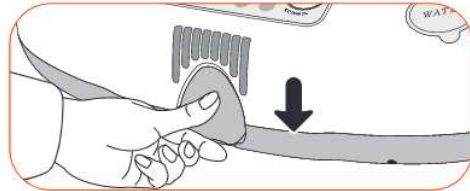

▶ Lock the three locking buttons at the front and rear of the incubator.

7

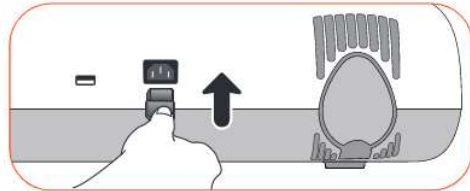

▶ Insert the power cord in the socket at the back of the main body.

⚠ Caution when assembling the air fin

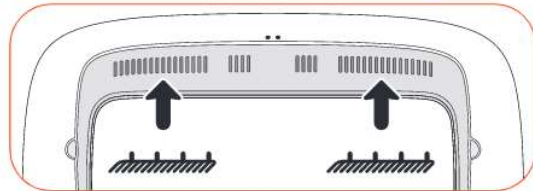

⚠ Two air fins are provided and attached to the main body(upper). You can use the incubator with the air fins attached. When the air fins are removed for cleanings, ensure that they are reattached in the same position and direction after cleaning. If the position and direction of the air fins are different, it may affect the resulting hatch rates, so please ensure this procedure is followed.

⚠ Caution when assembling the egg-turning plate

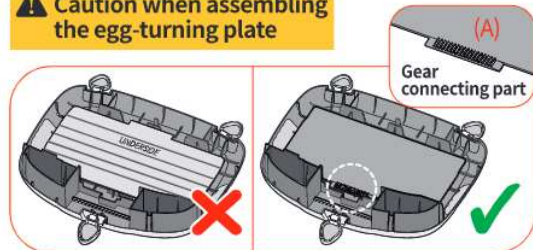

⚠ If the egg-turning plate is not assembled correctly, it may cause incubator failure. The gear connecting part (A) of egg-turning plate must be on the top side.

2. Before use

(1) How to Assemble the Incubator / Egg-turning plate

● Rcom PRO 50 DO

5 Window



4 Standard egg tray

* Can equip only one tray

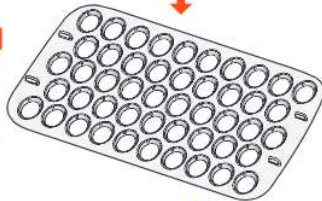

3 Main body

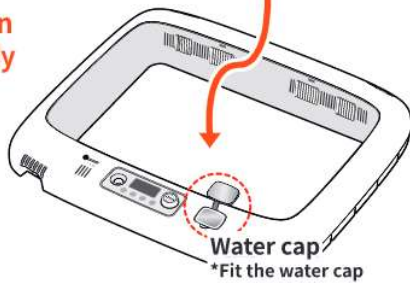

2 Egg-turning plate

*Attention of the direction

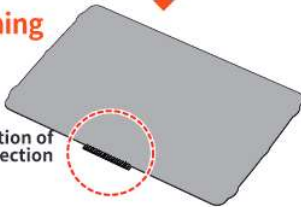

1 Bottom body

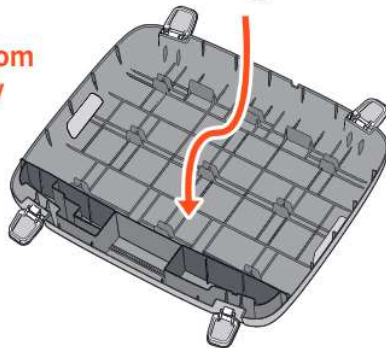

6 ▶ Lock the four locking buttons at the front and rear of the incubator.

7 ▶ Insert the power cord in the socket at the back of the main body.

⚠ Caution when assembling the window

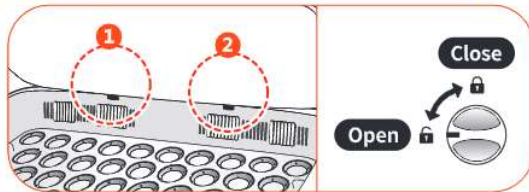

⚠ Please align the two lugs on the back side of the view window to the body (top) as shown in the picture. It is not assembled in the reverse order. Please don't lift the product with the handle of the view window in the locked status.

⚠ Caution when assembling the air fin

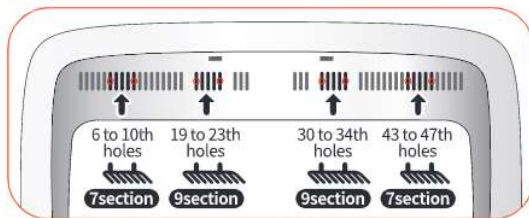

⚠ Four air fins are provided and attached to the main body(upper). You can use the incubator with the air fins attached. When the air fins are removed for cleanings, ensure that they are reattached in the same position and direction after cleaning. If the position and direction of the air fins are different, it may affect the resulting hatch rates, so please ensure this procedure is followed.

⚠ Caution when assembling the egg-turning plate

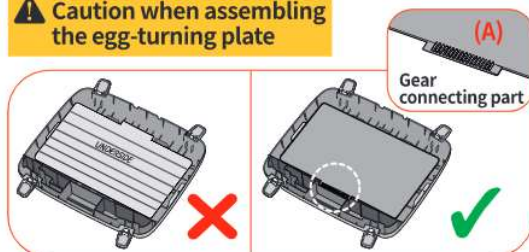

⚠ If the egg-turning plate is not assembled correctly, it may cause incubator failure. The gear connecting part(A) of egg-turning plate must be on the top side.

2. Before use

(2) What is incubation room?
(3) Preparation of incubation

● What is incubation room?

The Incubation room is a confined space for setting and operating an incubator efficiently. An Incubation Room environment has a considerable effect on hatch rate. Controlling the incubator environment is recommended; there should be little noise or vibration and constant temperature ranging upwards from 22~25°C(71.6~77°F) with small variation in temperature. For optimum performance, pay attention that your incubator isn't exposed to temperature drops compared with daytime. Do not expose the incubators to sunlight during daytime and also ensure that incubator is not placed near drafts or wind from air conditioning units.

● Preparation of incubation

- ▶ When power is connected, the current temperature and humidity are showed in the display.

Tip : It may smell a little in first operation however this is normal.

- ▶ Open the water cap and fill the hole with the distilled water, and refill water after about 5 minutes again up to the limit line on its inside mark.

Water quantity for Rcom PRO 20 DO: 800cc

Water quantity for Rcom PRO 50 DO: 1300-1400cc

Pouring more water than needed will result in an overflow through the water drainage hole below the main body (bottom).

⚠ If you use Mineral water or Tap water for humidification, the humidity unit can be broken easily because of water scales. We strongly recommend you to use only "DISTILLED WATER" for your machine, and Autoalex Co.,Ltd & our distributors do not indemnify for warranty service not only if you have any problem with using mineral water, regular water, tap water and the like but also if you had improper management or handling for your machine. In this case, Autoalex Co.,Ltd. & our distributors will charge for your after service.

⚠ Please note that shaking the incubator body after filling water will cause it to spill out and cause breakdown.

Tip : During incubation period, check the level of water once every 3 days and replenish it with distilled water. (After replenishing distilled water, check again after 5minutes and refill again)

⚠ When using the incubator without humidifying water or at a low humidity under RH 30%, you must stop the humidification function. If you keep the humidity unit on without enough water, the unit will be damaged or its life will be shortened. When the humidification function is stopped, the Humidification lamp and Water Empty alarms will be off.
[How to turn off the humidification function: see page 20]

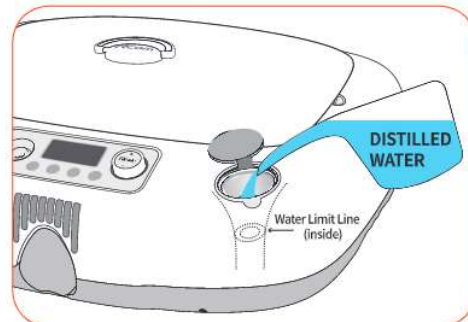
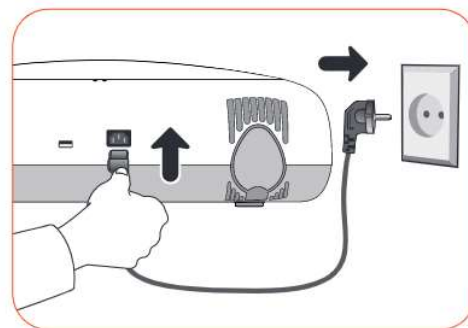

2. Before use

(3) Preparation of incubation

- ▶ Place the egg(s) in the suitable tray according to the size of the egg(s). The eggs to incubate must be fertilized eggs.

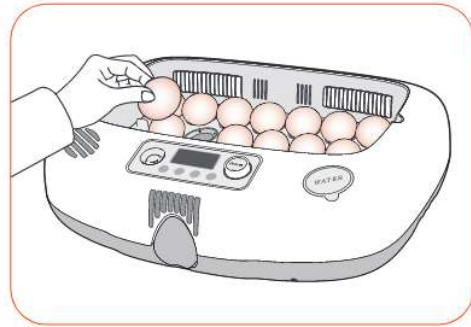

- Optional: Universal tray + Divider(1 set of 10ea.)**
Adjust the space of dividers according to egg size.

- ⚠ When using the universal tray, there must be some gaps (approximately 2 mm) between the ABS divider and the egg for easy egg turning.

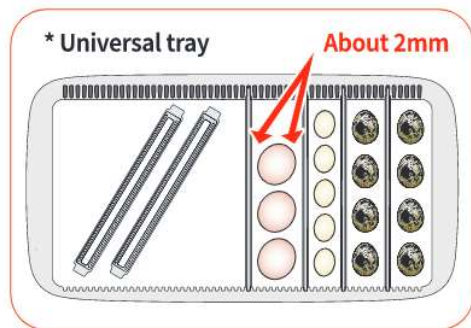

- Optional: Rolling dividers (1 set of 10ea.)**
* Accessories for Rcom PRO 20 DO
Fit rubber rings around the roller dividers and place the eggs on them keeping the proper spacing to prevent the eggs from rolling off.

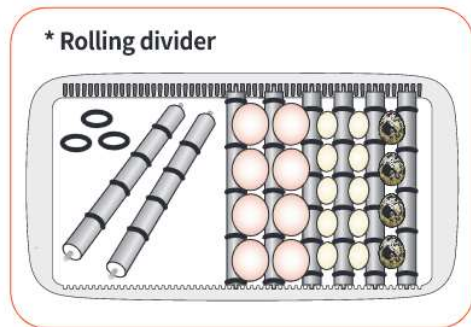

- ▶ Close the view window.

- ⚠ Be careful to close the view window completely. If not, the temperature and humidity will fail to go up.

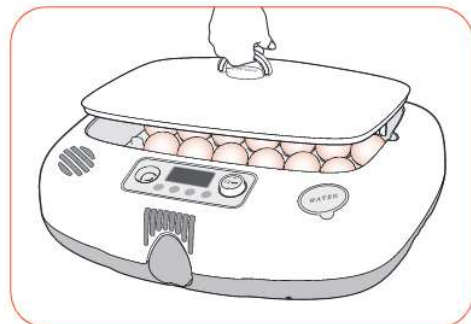
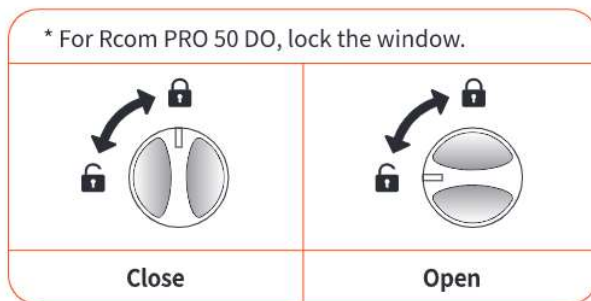

- ⚠ Make sure to operate the machine sufficiently to check that all functions are working properly before putting in eggs and starting hatching.

3. Function settings

(1) Incubation modes

● Incubation modes

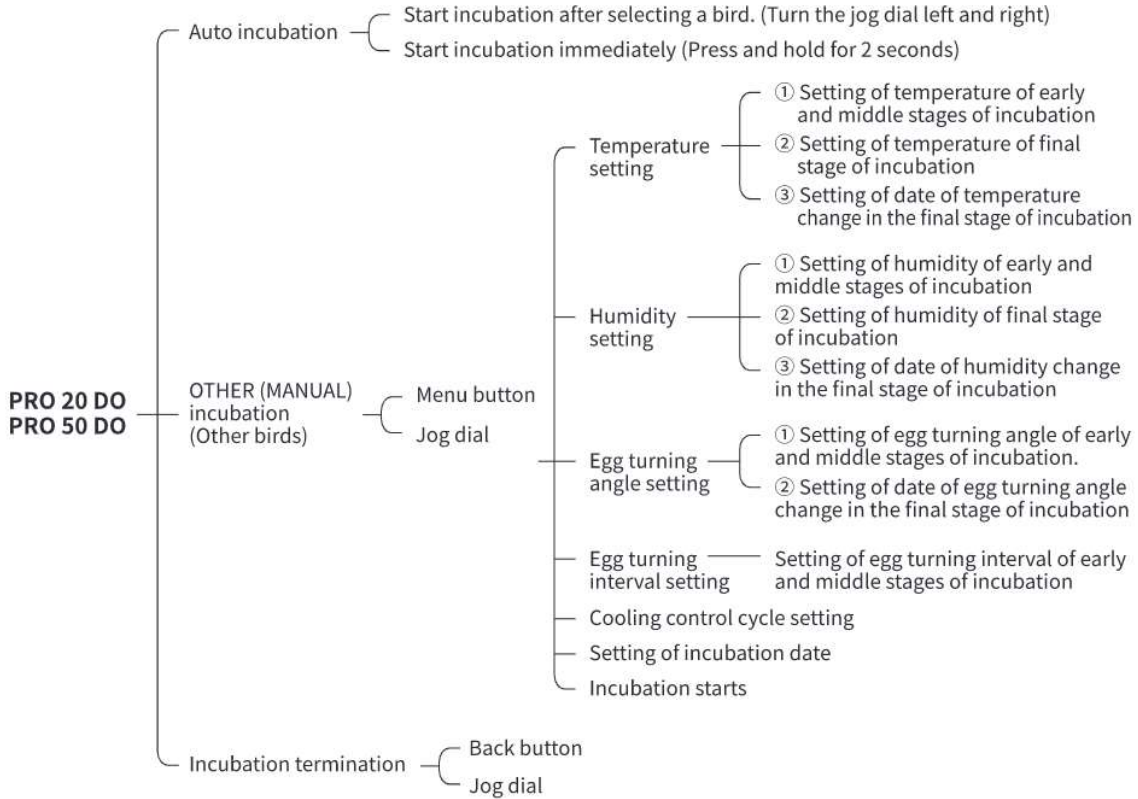

- ▶ During incubation, press Menu button to select terminate incubation. Press Back button to return previous step. Press Option button and the option menu will be shown on the display.

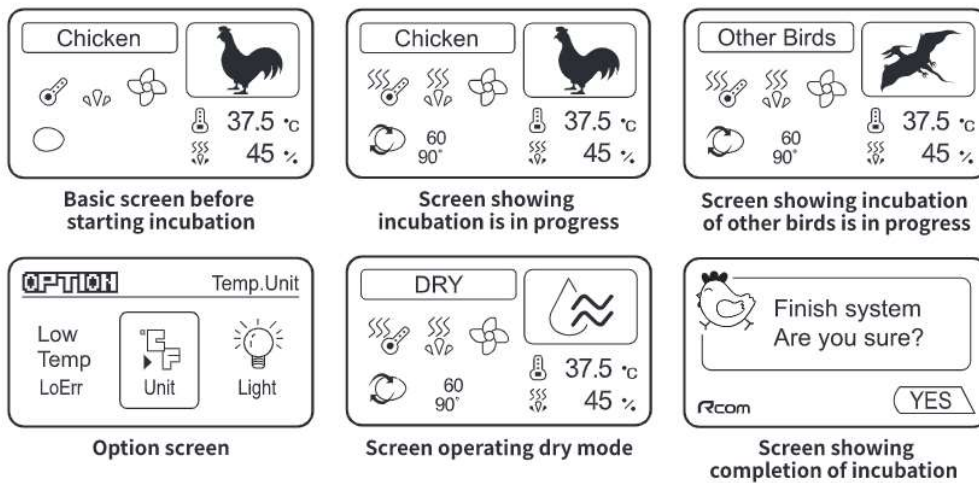

3. Function settings

(2) Incubation start with automatic mode

● Incubation start with automatic mode

The optimum incubation environment of the birds on the menu screen is memorized in the micro chip. User can incubate easily using this function.

- ▶ When the power cord is connected, the ambient LED flashes in blue on the control panel. (Before starting incubation or after finished incubation)

Tip : You can adjust, select functions and values by turning the jog dial left and right or pressing it. Pressing Back button, the set value is not saved and returns to the previous step.

- ▶ Turning the jog dial on the initial screen can select the birds in the order of the picture shows. According to the selected bird, the incubation days, early stage setup (temperature, humidity, egg turning cycle, egg turning angle) will be shown.

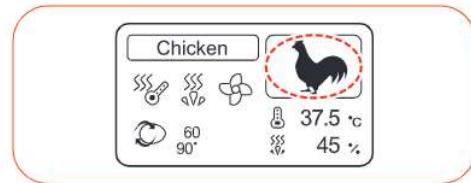
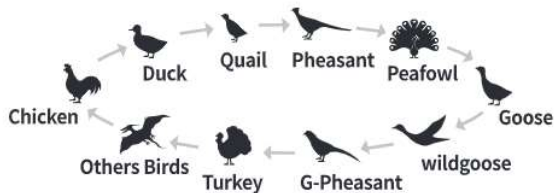

- ▶ Press the jog dial and hold for 2 seconds when selecting bird type, Now it starts automatic incubation mode with a message/melody.

Tip : In auto incubation, user only needs to select type of birds as incubation environments such as optimum temperature, humidity, egg turning, etc. are automatically controlled. User can change incubation environments if needed.

- ▶ When the incubation started, the ambient LED on the control panel is displayed in white. (early and mid-incubation stages)

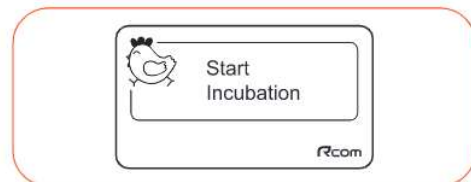

3. Function settings

(3) Incubation start with manual mode

● Incubation start with manual mode

This mode helps users to set temp. humidity, and egg turning etc. according to their needs. This mode is ideal for those persons who are experienced in incubation.

- ▶ When the power cord is connected, the ambient LED flashes in blue on the control panel. (Before starting incubation or after finished incubation)

Tip : You can adjust, select functions and values by turning the jog dial left and right or pressing it. Pressing Back button, the set value is not saved and returns to the previous step.

- ▶ Press the Menu button on the initial screen to enter the manual incubation setup mode.

- ▶ A list of birds is shown. Choose the wanted bird.

Tip : If there is no proper option, please select option other bird, Refer to Page19.

- ▶ Setup the wanted value by following steps : temperature, humidity, egg turning angle, egg turning interval, cooling control cycle and incubation days.

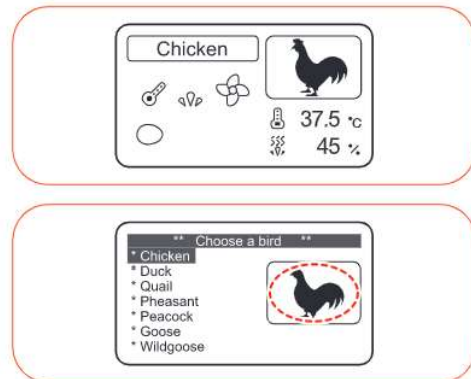

[STEP 1 Temperature setting]

- ① **Setting the temperature of early and middle stages of incubation.**
- ② **Setting the temperature of final stage of incubation.**
- ③ **Setting the temperature change date in the final stage of incubation.**

- ▶ Optimum incubation temperature of general birds at :
 - ① early and middle stages is 37.5°C,
 - ② the temperature of final stage is better to set at 37°C.
 - ③ final stage is three days before the expected date of hatching (D-Day).Users can optionally change the temperature values in ①~③(early, middle, and final stages) of incubation.

[Default settings : For chicken, ① 37.5°C ② 37.0°C ③ 3days]
[Setting range : 20 ~ 42°C (68 ~ 107.6°F)]

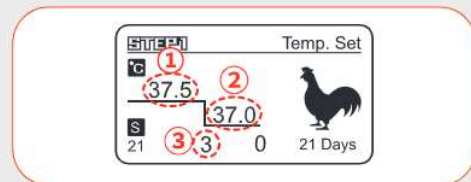

[Temperature setting]

Tip : During the final stage(three days before the expected hatching date), it is better to set the temperature 0.5°C lower, because the chick(s) inside the egg(s) keeps a little higher temperature.

3. Function settings

(3) Incubation start with manual mode

[STEP 2 Humidity setting]

④ Setting the humidity of early and middle stages of incubation.

⑤ Setting the humidity of final stage of incubation.

⑥ Setting the humidity change date in the final stage of incubation.

- ▶ The optimum humidity depends on type of birds.
⑤ However the humidity of final stage (3 days before incubation) is generally higher than ④ that of early and middle stages of incubation.

[Default settings : ④ 45% ⑤ 65% ⑥ 3days]
[Setting range : 30 ~ 70%]

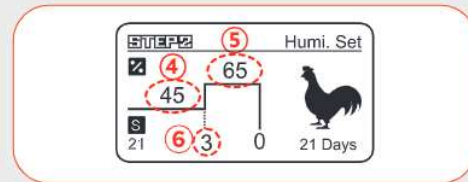

[Humidity setting]

Tip : It is recommended to raise the humidity setting to more than 60% from 1~3days before hatching. (In areas of high ambient humidity, the humidity may not need to be raised until the last half day - after the chick is in the air cell)

Tip : Temperature and humidity is optimizely calibrated according to international standards when Rcom products are manufactured. We do not recommend customers to recalibrate by their own. If you need to recalibrate, please visit our website (www.rcom.co.kr→Download→Manual) or ask purchased store. Because of inexpensive thermometers and hygrometers are not accurate, we recommend using dedicated calibrated thermo-hydrometer. (Exclusive thermo-hydrometer: check Rcom website: Digilog3)

[STEP 3 Egg-turning angle setting]

⑦ Setting the egg-turning angle of early and middle stages of incubation.

⑧ Setting the egg turning angle change date in the final stage of incubation.

- ▶ The egg turning angle showing on LCD screen may be different from the setting angle depending on egg tray (based on standard egg tray) and size of eggs.
⑦ In general, the egg turning angle of early · middle stages of incubation is 90° for chicken, golden pheasant and pheasant. It is better to set higher angle (110 ~ 180°) for bigger eggs and wild birds. It is a general practice not to turn eggs (turn angle is 0°) at final stage of incubation.
⑧ Final stage of incubation is normally 3 days before from the expected hatching date.

[Default settings : For chicken ⑦ 90 ° ⑧ 3days]
[Setting range : ⑦ 0 ° , 15 ~ 180 ° (15 ° per click), rnd ⑧ 1 ~ incubation days]

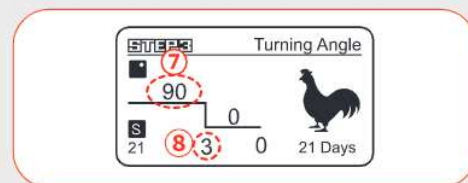

[Egg turning angle setting]

Tip : When "rnd" (Random) is set, the egg turning angle is between 75~180 ° at random.

! It might have difference between the egg turning angle in display and actual operating, Please find and select the proper angle.

3. Function settings

(3) Incubation start with manual mode

[STEP 4 Egg turning interval setting]

⑨ Setting the egg turning interval of early and middle stages of incubation.

- ▶ It is a function ⑨ to set the egg-turning interval(time). It turns the eggs with the set angle for every 60mins. during the early and middle stages.

⑨ Users can set the egg-turning interval by their own.

[Default settings : 60min.]

[Setting range : rnd, 10 ~ 360mins(10mins per click)]

Tip : "rnd"(Random) setting is for operating at random within 10mins to 360mins.

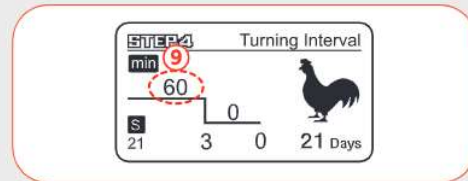

[Egg turning interval setting]

[STEP 5 Cooling control cycle setting]

⑩ Setting of cooling control cycle of early and middle stages of incubation.

⑪ Setting of cooling control cycle of final stage of incubation.

⑫ Setting of cooling control cycle change date in the final stage of incubation.

- ▶ ⑩, ⑪ It is a function which stops heating for the set time during 24 hours a day.

⑫ Final stage of incubation is normally 3 days before from the expected hatching date.

[Default settings : ⑩, ⑪ off ⑫ 3days]

[Setting range : ⑩, ⑪ off, 10, 20, 30 · · · , 340, 350, 360mins
⑫ 1 ~ incubation days]

Tip : Periodic cooling helps to achieve hatching successfully, but prior knowledge may be required to perform cooling control functions.

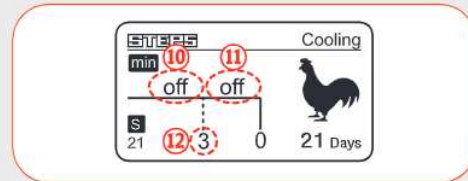

[Cooling control cycle setting]

[STEP 6 Incubation date setting]

⑬ Setting of incubation date(D-Day).

- ▶ The incubation date of selected birds on menu screen is a general incubation date and users can input the correct incubation date. Incubation date setting cannot be changed during incubation.

[Default settings : depends on type of birds]

[Setting range : 1 ~ 50days, "?"]

Tip : Select "?" can continue incubation with early and middle stage set value without terminating incubation.

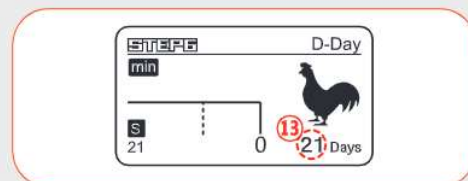

[Incubation date setting]

[Complete setting and incubation start]

- ▶ Once the last step [Incubation date setting(D-day)] is completed, a message, "Start system are you sure?" appears.

- ▶ Choose YES and now it starts manual incubation mode with a message/melody.

- ▶ When the incubation is started, the ambient LED flashes in white on the control panel. (During early and mid-incubation stages.) The ambient LED turns into green if other than default value is entered.

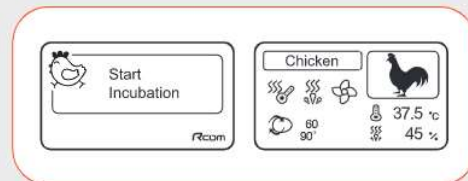

3. Function settings

(4) Incubation start for other birds

● Incubation start for other birds

This function is used when user wishes to incubate other birds which are not memorized in the incubator menu setting. User can change incubation conditions according to needs.

- ▶ When the power cord is connected, the ambient LED flashes in blue on the control panel. (Before starting incubation or after finished incubation)

Tip : You can adjust, select functions and values by turning the jog dial left and right or pressing it. Pressing Back button, the set value is not saved and returns to the previous step.

- ▶ Press Menu button on the initial screen.
- ▶ Select “Other Birds” and enter the incubation environment setup mode.
- ▶ After setting the D-Day for hatching, set temperature, humidity, turning angle, turning interval and cooling control cycle you want by turning the jog dial to the left and right then press the jog dial to save the settings. [Refer to the Page 16~18]

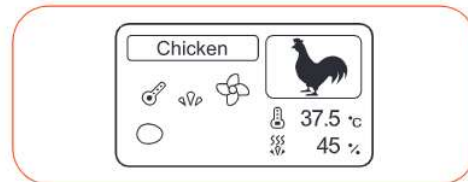

Tip : WHAT is repetitive incubation?

It is a function that allows you to operate the egg incubator repetitively with the same incubation conditions currently you set, regardless of the days hatching take. How to set repetitive incubation : when setting the D-day, set up to D-50Days and turn the jog dial once again, “?” mark comes up. Then, press the jog dial to move temperature input display.

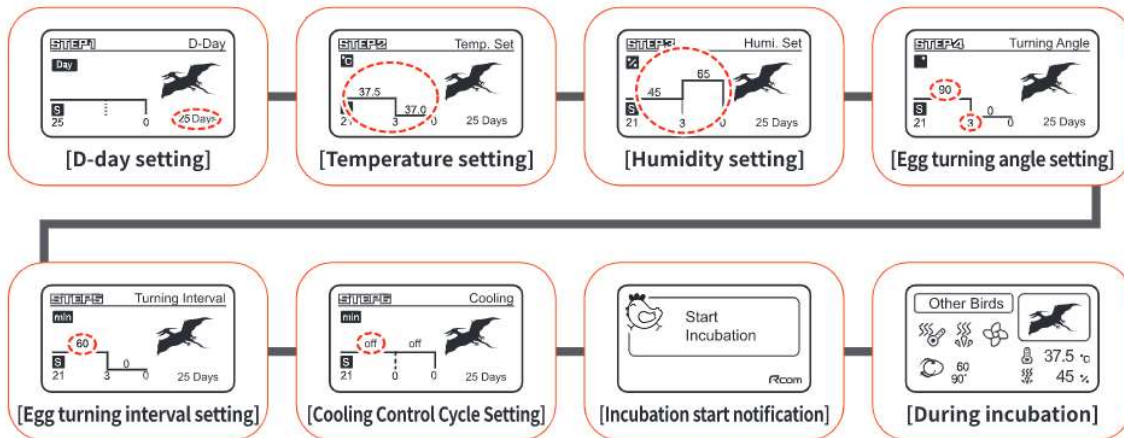

- ▶ When the incubation started, the ambient LED on the control panel is displayed in white. (early and mid-incubation stages)
The ambient LED turns into green if other than default value is entered.

3. Function settings

(5) Incubation condition reset during Incubation
 (6) How to set turn ON/OFF humidification function

● Incubation condition reset during Incubation

- ▶ During the incubation, press the MENU button to change settings.
- ▶ To change the temperature, turn the jog dial to reset the value.
 (Adjust settings in the following steps :
 Temperature → Humidity → Egg-turning angle →
 Egg turning interval → Cooling control cycle)
 By pressing the jog dial again, you can save the setting with a message “Parameter saved”.

Tip : Pressing Back button, the set value is not saved and returns to the previous step.

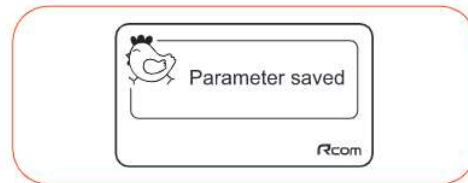
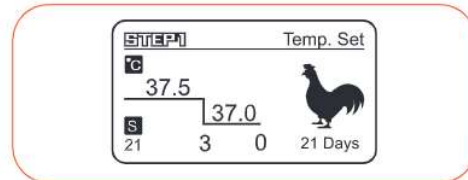

[Setting save message]

● How to set turn ON/OFF humidification function

! If you use the incubator without adding humidification water or intend to incubate eggs at low humidity under 30%, you must stop the humidification function.

- ▶ Continue to change setting by pressing MENU button.
- ▶ The humidity setup screen blinks if you press the jog dial once when the temperature setup screen is blinking. At this time, turn the jog dial to lower the humidity setting until display shows “OFF”, then press the jog dial to save the set value with “Parameter saved” message. On the contrary to this, the humidification function turns on if you setup more than 30%.

[Default settings : on]

[Setting range : on / off]

Tip : Pressing Back button, the set value is not saved and returns to the previous step.

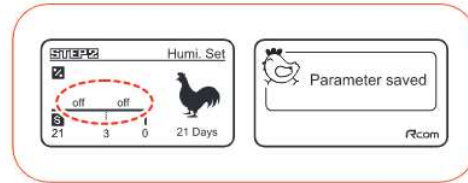
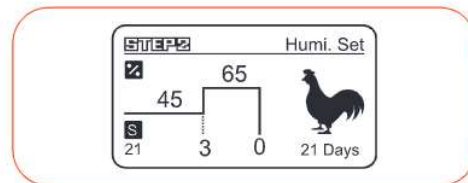

[Humidification ON / Humidification OFF]

● How to set egg turning test, egg turning check

- ▶ During the incubation, if you turn the jog dial left or right and confirm start egg-turning. It starts egg-turning for once if you select YES. The animation appears with a melody when egg-turning starts.
- ▶ When Egg-Turning fails to work, please check if the Egg-Turning plate is assembled correctly. [How to Assemble : see page 10~11]

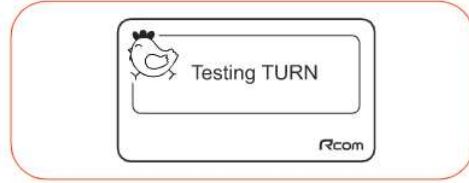

● Candling

Tip : Candling allows observation of the fertilized, unfertilized, suspended hatching or development of embryo. If there is any minute fissure on the egg after introducing to the incubator, the germs penetrate into it therefore the decomposition starts. It is therefore advisable to discard non fertile or contaminated eggs. It is also recommended to perform candling in the dark for improved visibility.

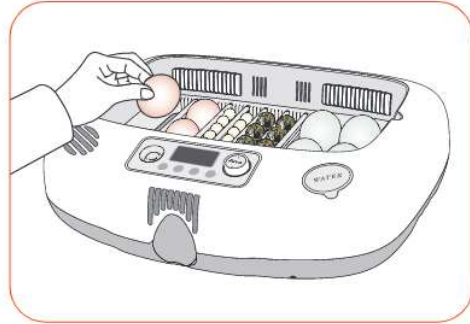

⚠ Do not directly look into the LED light except in case of candling.

- ▶ The environment for candling must be dark for easier candling.
- ▶ Place the wide, round part of the egg onto the candling zone of the control panel, press the candling button to observe the inside of the egg (embryo or blood vessel). For safety, it lights up 1 seconds after the button is pressed.

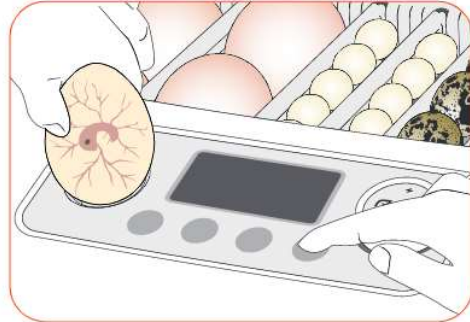

⚠ Candling can be verified with the naked eye from 5 to 7 days after starting incubation.

If blood vessels or embryos are not observed, the egg may be unfertilized egg therefore remove it from the incubator. If the egg shell is thick or dark, the inside may not be visible. White eggs as duck eggs are easier to observe.



⚠ During candling, the ambient room temperature is lower than the inside of the incubator. Therefore, candling should be done in a warm room and finished within 10 minutes. Please pay special attention not to apply any impact on the eggs. Eggs may die due to stress caused by severe shaking or turning. Too frequent candling may cause failure to hatch.

⚠ If the egg breaks in the candling zone, the liquid will flow inside and cause a breakdown. Care must be taken when examining eggs.

3. Function settings

(9) Alarm for water supplement (10) Power failure alarm function
(11) How to set the dry mode (12) How to setup abnormal High/Low temperature alarm

● Alarm for water supplement

- ▶ When water is running low, the water drop shaped “HUMIDITY” mark on the main page turns from  →  and an alerting message pops up with alerting sounds every 3 minutes.

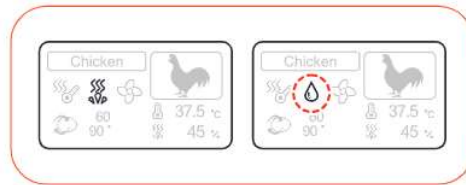

- ⚠ It takes several minutes to get back to normal state once water is supplied.

● Power failure alarm function

- ▶ When you first switch on the power, or in case of power failure during incubation, display shows this icon  and incubator and incubator alarm sounds for about 10sec. Press jog dial to remove.

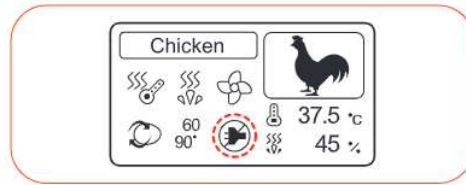

● How to set the dry mode (Option)

- ⚠ ALWAYS OPERATE [DRY MODE] BEFORE STORAGE after the hatching has been completed. Otherwise, it may cause malfunction on electronic device and sensor unit due to moisture remaining inside. Only after cleaning inside of the machine, empty the humidification water, and start [How to clean : see page 26~27].

- ▶ Option Menu will be shown by pressing the Option button. Turn the jog dial to select the [Dry Mode], and enter drying mode ON/OFF.



[YES : drying mode on / NO : drying mode off]

- ▶ When YES is selected the drying mode is activated for 30 minutes.

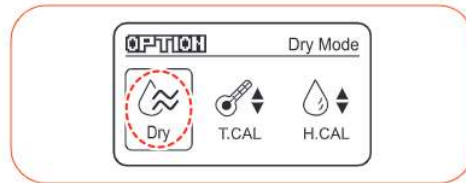
Tip : (During setup stage) Pressing Back button, and the set value is not saved and returns to the previous step. If you want to stop while dry mode is running, press the jog dial for 3 seconds.



● How to setup abnormal High/Low temperature alarm (Option)

- ▶ WHAT is an abnormal temperature alerting function? It is a function that alerts the user to an abnormally high or low temperature inside the incubator.
- ▶ When incubator temperature is different from setting value, icon is changed  → , and display indicates current temp. and temp. difference alternatively.

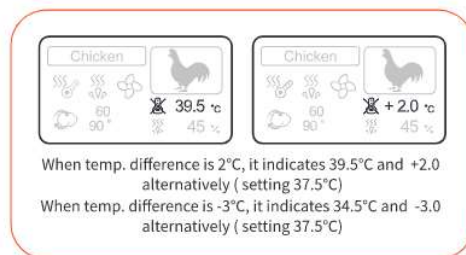

3. Function settings

(12) How to setup abnormal High/Low temperature alarm
(13) How to change Celsius/Fahrenheit

! The alerting sounds set off for 1 minute and automatically stops. The alerting sign stays on until the jog dial is pressed.

[How to Set Abnormal High Temp. Setting]

: When incubator temp. is higher than setting temp.

- ▶ Option Menu will be shown by pressing the Option button. Turn the jog dial to select the [High Temp. Set] and press the jog dial.
- ▶ Turn the jog dial to adjust the value in [Abnormal High Temperature Mode]. Press dial to save the setting value after adjusting to the desired value.
[Default settings : 2°C (2°F)]
[Setting range : 0.0 ~ 5.0°C (0.0 ~ 5.0°F)]

Tip : (During setup stage) Pressing Back button, and the set value is not saved and returns to the previous step.

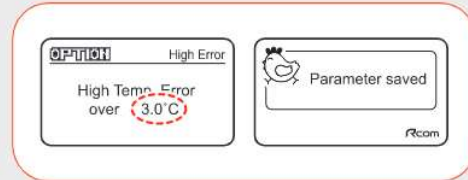
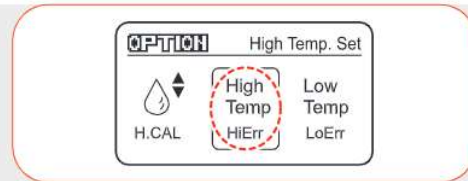

[How to Set Abnormal Low Temp. Setting]

: When incubator temp. is lower than setting temp.

- ▶ Option Menu will be shown by pressing the Option button. Turn the jog dial to select the [Low Temp. Set] and press the jog dial.
- ▶ Turn the jog dial to adjust the value in [Abnormal Low Temperature Mode]. Press jog dial to save the setting value after adjusting to the desired value.
[Default settings : -3°C (-3°F)]
[Setting range : 0.0 ~ -5.0°C (0.0 ~ -5.0°F)]

Tip : (During setup stage) Pressing Back button, and the set value is not saved and returns to the previous step.

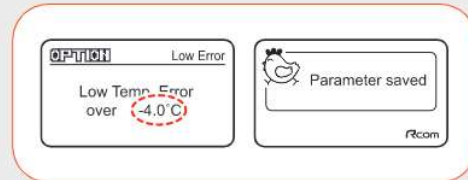
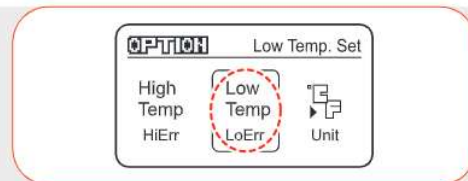

● How to change Celsius/Fahrenheit (Option)

- ▶ Option Menu will be shown by pressing the Option button. Turn the jog dial to select the [Temp. Unit] and press the jog dial.
- ▶ Turn the jog dial to select the unit of temperature in [Change Cels. & Fahr. Mode]. Press jog dial to save the setting after selecting desired unit of temperature.
[Default settings : Celsius °C]

Tip : (During setup stage) Pressing Back button, and the set value is not saved and returns to the previous step.

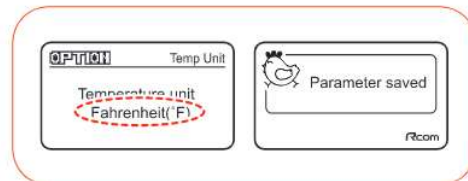
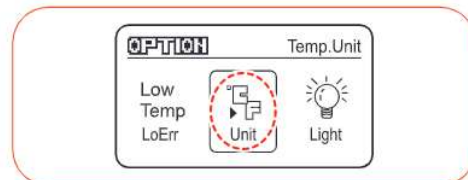

3. Function settings

(14) How to turn the backlight ON/OFF/EVENT ON (15) How to ON/OFF sound
(16) Return to factory settings (17) How to terminate incubation

● How to turn the backlight ON/OFF/EVENT ON (Option)

- ▶ Option Menu will be shown by pressing the Option button.
Turn the jog dial to select the [Light] and press the jog dial.
- ▶ Press jog dial to save the setting after selecting of desired value.
[Default settings : Always ON]
[Setting range : Always ON / Always OFF / 20 Sec. ON with key input : Event ON]

Tip : (During setup stage) Pressing Back button, and the set value is not saved and returns to the previous step.

● How to ON/OFF sound (Option)

- ▶ Option Menu will be shown by pressing the Option button.
Turn the jog dial to select the [Sound] and press the jog dial.
- ▶ Press jog dial to save the setting after selecting of desired value.
[Default settings : ON]
[Setting range : ON, OFF]

Tip : (During setup stage) Pressing Back button, and the set value is not saved and returns to the previous step.

● Return to factory settings

Tip : Used to initialize equipment to a setting when it was first released from the factory in case where the input value is changed due to mal-operation of equipment.

- ▶ Press the jog dial for 10 seconds to enter [Return to Factory Setting] and a message “Return to Factory Setting?” will be shown.
- ▶ After selecting YES by turning the jog dial and press, the LCD screen goes off with a message/alarm sound. Incubator returns to factory setting after about 15 seconds. If select No and press the jog dial, the setting will not be saved and return to previous screen.

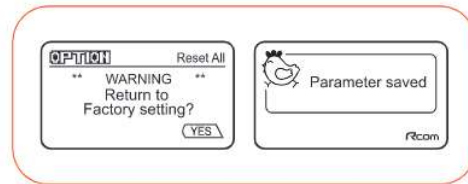

● How to terminate incubation

! After all the incubation has been completed, you must operate the [Drying Mode]. Otherwise, it may cause malfunction on electronic device and sensor unit due to moisture remaining inside. Only after cleaning inside of the machine, empty the humidification water, and start [Drying Mode : see page 26~27].

- ▶ During the incubation, press BACK button and you can see a message “Finish system Are you Sure?”.
- ▶ After selecting YES by turning the jog dial and press, Incubation will be terminated and returns to initial screen. If select No and press the jog dial, the setting will not be saved and return to previous screen.

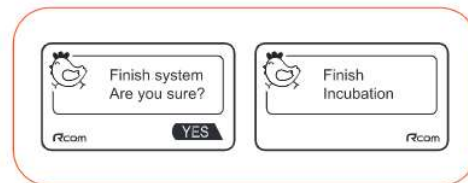

[Terminate incubation]

4. Incubation

● Humidity and ventilation control during incubation

- ▶ When hatching, inside humidity of the incubator should be relatively high to prevent the thin membrane from drying out or hardening before hatching.
- ▶ When hatching, it's recommended not to open the lid often. This is because if you open the lid often humidity will be rapidly decreased and it will take a long time to regain the proper humidity.

! Incubator internal temperature is 37°C (99.5°F) or more, and hatching room temperature is below 28°C, in that case, 70% humidity is may not be able. The difference of ±5% humidity value may occur from the humidity sensors difference, and there are no problems at hatching.

- ▶ It's very important to maintain humidity higher 1~3 days before hatching than the early and middle incubation periods. Humidity requirements during incubation are 45~55% for waterfowl, 40~45% for poultry and 35~45% for parrot, in general. One day before hatching, all kinds of birds need about 60~65% humidity and sometimes need higher than that. However, in areas of high ambient humidity, lower levels of humidity may be needed during incubation. The humidity is automatically set at 65% when selecting the end stage incubation setting.



● Management after incubation

- ▶ It is necessary to use a brooder for baby chicks because they are too weak to survive cool temperatures. It is also recommended to use a separate hatcher where possible, as this prevents feathers and dirt contaminating your incubator. If your incubator fails because of dirt and contamination then it will not be covered by the free warranty.

Tip : Hatcher : The machine for egg-hatching. Operate it 1~3 days before egg-hatching. (Rcom MARU H&B)
Brooder : The machine makes baby chickens or birds warm up against cold or cool environment. You can set up proper temperature and humidity. (Rcom Kingsuro brooder / Rcom MARU H&B / Rcom Bird brooder)

- ▶ As there is some difference in chick feed for each kind of bird, so it's desirable to obtain useful information about the chicks before hatching.

! Be sure to use a three-wavelength 20W bulb. If you use a bulb over 20W, temperature goes up, possibly killing the chick or causing a fire. If there is too much water and a chick would fall into water, its feathers get wet and it can be died of loss of body heat. Here, dry feathers with a hairdryer, etc.
Be sure to use a three-wavelength 20W bulb : In case breeding room size 370(mm) x 270(mm) x 130(mm)

● Dew condensation

- ▶ This is a naturally occurring phenomenon when there is a significant difference in temperature between inside and outside of the incubator during incubation period. If this occurs, water may form in inside bottom of the main body of the incubator(bottom part).

5. How to clean

(1) How to separate and clean

● How to separate and clean

⚠ Before start cleaning, make sure that all hatching, un-hatched eggs and pieces of shell inside are removed.

⚠ If the incubator goes through incubations several times, feather, dust, shell, etc. accumulate inside the main body, which may cause a breakdown. **ALWAYS BE SURE CLEAN THE INCUBATOR BEFORE STORAGE.**

▶ During humidification, a lot of alien matter sticks to the humidification heating part ① but this may not cause of failure. However, if you continue incubating and hatching without cleaning the scale, the humidification heater performance may deteriorated, **ALWAYS BE SURE TO CLEAN THE INCUBATOR AFTER FINISH HATCHING.** To reduce foreign substance, distilled water is recommended for humidification.

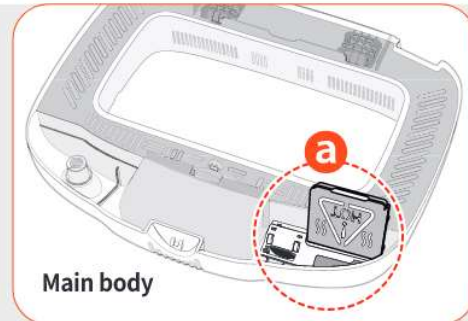

▶ Disconnect the power cord from the connection jack and also take out the plug from the power outlet.

⚠ Be sure to disconnect the machine's power cord from the power outlet.

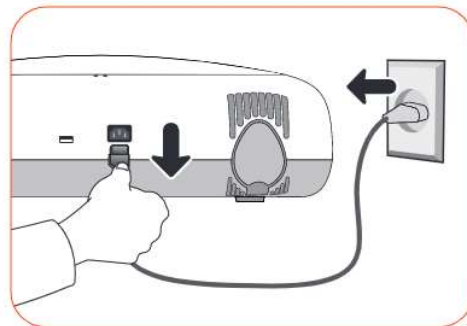

▶ Unlock and remove the locking buttons on the front and back of the incubator.

Rcom PRO 20 DO : 3
Rcom PRO 50 DO : 4

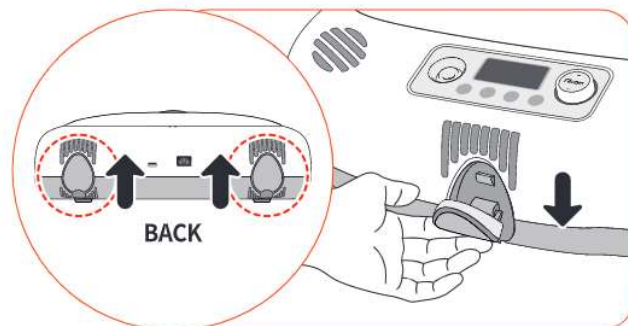

▶ After washing the tray, egg-turning plate, and body (bottom) thoroughly with water, dry them for a day in a well-ventilated place to completely remove the remaining moisture.

⚠ Please don't remove the black silicon cap on the back side of the body(bottom)

⚠ When cleaning the product, do not use organic solvents such as benzene, thinner, etc. It may cause deformation or discoloration.



5. How to clean

(1) How to separate and clean

- ▶ Remove scale with a toothbrush or a soft scrubber of the humidification unit on the main body(upper).

! Beware of humidification heater part may be hot. WE RECOMMEND TO START CLEANING AFTER A WHILE WHEN THE HEATHER PART BECAME COOL DOWN ENOUGH.

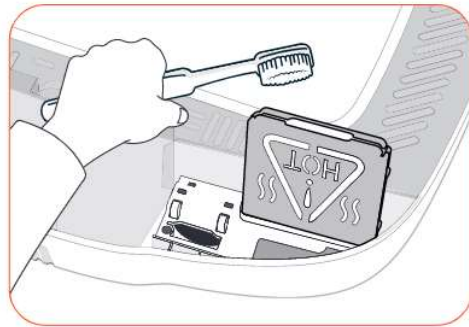

- ▶ Use a vacuum cleaner to remove the dust and thoroughly shake out the minute dust with a fine brush.

! In case the incubator clean status is poor, it may cause fan noisy or stopping.

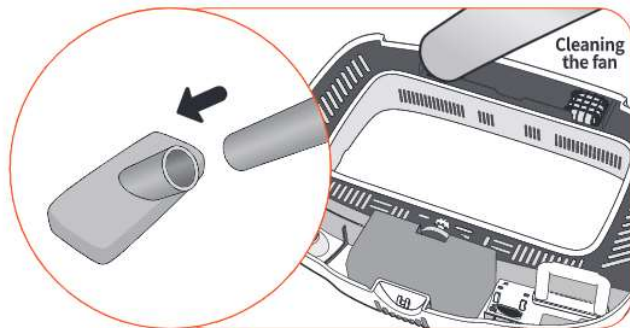

- ▶ After cleaning, reassemble in the reverse order of disassembly.
- ▶ Wipe the outside of the body with a damp cloth to clean it, and dry it in a cool, well-ventilated place before storage.
[How to assemble: refer to pages 10-11]

Tip : ALWAYS OPERATE [DRY MODE] BEFORE STORAGE after the hatching has been completed. Otherwise, it may cause malfunction on electronic device and sensor unit due to moisture remaining inside.
[How to operate Dry Mode : refer to page 22]

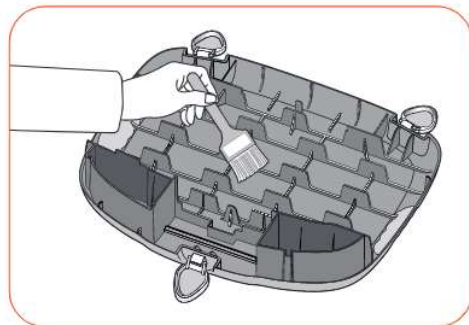

! Caution when assembling the air fin

! Four air fins are provided and attached to the main body(upper). You can use the incubator with the air fins attached. When the air fins are removed for cleanings, ensure that they are reattached in the same position and direction after cleaning. If the position and direction of the air fins are different, it may affect the resulting hatch rates, so please ensure this procedure is followed.

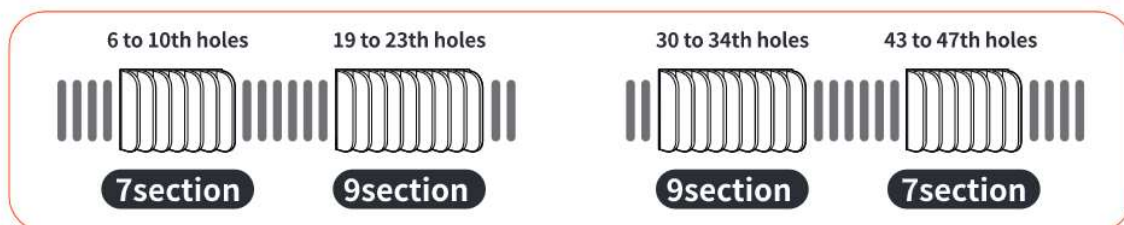

● FAQ

The Rcom products are manufactured under strict quality management with precise equipments, but there may be some defects in the product during the distribution. If there is any problem please contact to the Service center or Distributor of Rcom. We will do our best to resolve the problem as soon as possible. The product is designed in module methods which is easily replaceable by any qualified person.

* E-mail reception : sales@autoelex.com

Symptom	Estimated cause (possibility)	Solutions
If the average hatching rate is low	<ul style="list-style-type: none"> ▶ If the egg is unfertilized ▶ Germ infection ▶ Incorrect incubation setup ▶ Health condition of the mother bird ▶ Improper egg turning 	<ul style="list-style-type: none"> ▶ Candle the egg to verify if it's alive ▶ Sterilize the device ▶ Check all the setup process of the device Especially on the temperature ▶ Care the mother bird's health ▶ Verify if the egg turning is normally performed
If the chick is born earlier than the estimated date or when is malformed	<ul style="list-style-type: none"> ▶ If the setup temperature is too high ▶ If the egg turning is not performed 	<ul style="list-style-type: none"> ▶ Slightly decrease the temperature of the device [0.5°C (1°F)] Ex) 37.5°C → 37.0°C ▶ Initiate egg rotation test verifying if the egg turning function is not OFF
If the chick is born later than the estimated date	<ul style="list-style-type: none"> ▶ If the setup temperature is too low 	<ul style="list-style-type: none"> ▶ Slightly increase the temperature of the device [0.5°C (1°F)] Ex) 37.0°C → 37.5°C
If the hatching date of the eggs are too varied (when they're not hatched at the same time but differently during long term)	<ul style="list-style-type: none"> ▶ Difference of hatchery egg storage time ▶ Occurred from the diversity of hatching temperature 	<ul style="list-style-type: none"> ▶ When possible, minimize the egg storage period/time ▶ Check the temperature difference within the device (sunlight and temperature of hatching room, etc)
When desiring to hatch different types of eggs at the same time	<ul style="list-style-type: none"> ▶ The hatching rate is lowered as the days to hatch are different ▶ Eggs which didn't hatch can be contaminated by chicks hatched first 	<ul style="list-style-type: none"> ▶ Mark the hatching date on the egg and move to other device (generator) according to the estimated hatching date ▶ It is convenient if you have other additional devices which can be used as generator chamber when different eggs are placed together at the same time

⚠ Please verify if every function of the device is performed properly by operating sufficiently the device before locating the eggs. In case of incubation of costly eggs you might need check-up or adjustment of internal temperature to prevent failure of incubation. In the checkup or examination please use a high-reliability thermo-hygrometer. (Rcom Digilog3 model or higher)

● Troubleshooting and measures For more detailed self-diagnosis, see Rcom homepage "SELF DIAGNOSIS" category.

Symptom	Estimated cause (possibility)	Solutions
If the power is not on	<ul style="list-style-type: none"> ▶ Verify if the power cord is correctly inserted ▶ Verify if there is no power failure/blackout ▶ Verify if the plug is faulty or not 	<ul style="list-style-type: none"> ▶ Insert correctly the power cord again ▶ Verify other nearby electronic and electric devices ▶ Verify and try other power socket

6. Product information

(2) Troubleshooting and measures

<p>Temperature will not go high enough</p>	<ul style="list-style-type: none"> ▶ Check your setting temperature ▶ Check the air circulation fan is working ▶ Return incubator to factory setting [Refer to page 24] ▶ Verify if there is any water in the bottom 	<ul style="list-style-type: none"> ▶ Set the temperature as required ▶ Take the power plug out of the outlet, and disassemble the main body for cleaning around the air circulation fan with brush ▶ Eliminate the water inside the bottom
<p>Alarm sounds with HI indication (abnormal high temp.)</p>	<ul style="list-style-type: none"> ▶ Check if room temperature is too high ▶ Check if incubator is exposed to the direct rays of sun ▶ In case of lowering temperature 	<ul style="list-style-type: none"> ▶ Adjust room temperature 28°C (82.4°F) ▶ Install incubator without the direct rays of sun ▶ Return incubator to factory setting [Refer to page 24]
<p>Alarm sounds with LO indication (abnormal low temp.)</p>	<ul style="list-style-type: none"> ▶ Check if room temperature is too low (especially during night) ▶ Check if incubator heater(temperature controlling-system) is normally working ▶ Please check the bottom of machine is wet or not 	<ul style="list-style-type: none"> ▶ Adjust room temperature 28°C (82.4°F) ▶ Place thermometer inside of incubator and check if setting temperature is correct ▶ Return incubator to factory setting [Refer to page 24] ▶ Please remove moisture
<p>Humidity will not go high enough.</p>	<ul style="list-style-type: none"> ▶ Check your setting humidity. ▶ Close the view window again after checking ▶ Return incubator to factory setting [Refer to page 24] ▶ Please check the surrounding temperature is too low 	<ul style="list-style-type: none"> ▶ Supply water ▶ Set the humidity again as required ▶ Please move the incubator to a warm place
<p>The machine makes some noise. * A little noisy occurs from the inside of circulation fan</p>	<ul style="list-style-type: none"> ▶ Check if there is any hatching dust such as feather or eggs-shell in the incubator fan ▶ A little noisy is not faulty 	<ul style="list-style-type: none"> ▶ Take out the plug out of the outlet and disassemble the main body and clean around the air circulation fan with brush
<p>Egg-Turning fails to work.</p>	<ul style="list-style-type: none"> ▶ Please confirm if its status of stopped egg-turning. (whether egg-turning indication appears) ▶ Check that there are no foreign items on the egg turning plate ▶ Check if egg turning plate is assembled correctly 	<ul style="list-style-type: none"> ▶ If you need egg-turning, switch to automatic egg-turning mode. ▶ Unplug the power supply and disassemble the main body for cleaning the egg turning plate and gear ▶ Assemble egg turning plate as the picture on page 10~11
<p>Dew foams in the incubator</p>	<ul style="list-style-type: none"> ▶ Check the incubator is not placed too cold circumstances ▶ When you turn OFF incubator and then turn on ▶ In case of setting high humidity 	<ul style="list-style-type: none"> ▶ Adjust room temperature 22~25°C(71.6~77.5°F) [Refer to page 12] ▶ Dew condensation is a natural phenomenon and not a malfunction of the device [Refer to the page 25]
<p>Water leaks from the machine</p>	<ul style="list-style-type: none"> ▶ Check that you have not overfilled the incubator ▶ Check that the incubator placed on inclined surface ▶ Check if it is Dew condensation ▶ When moved without taking out the water for the humidifier unit 	<ul style="list-style-type: none"> ▶ Do not fill water over LIMIT indication. ▶ Place incubator under a level surface. ▶ Remove the remaining water in the humidity unit
<p>“Err 01” appears and an alarm sounds. (Temperature / humidity sensor error)</p>	<ul style="list-style-type: none"> ▶ Please contact the customer service center 	

6. Product information

(3) Specification /
Guide to Consumer Damage Compensation

● Specifications

1-1 Name : Rcom PRO 20 DO
1-2 Model NO. : PX-20DO

2-1 Name : Rcom PRO 50 DO
2-2 Model NO. : PX-50DO

Model NO.		PX-20DO	PX-50DO
Power		AC 100~120V, 50/60Hz / AC 220~240V, 50/60Hz	
Temp. Limits	Automatic	Automatic setting for each birds (manual control available)	
	Manual	20 ~ 42°C	
Working temperature		Ideal : 20 ~ 25°C (68~77°F) / MIN. : 15°C / MAX. : 30°C	
Humi. Limits	Automatic	Automatic setting for each birds (manual control available)	
	Manual	30 ~ 70% (It can be changed according to the conditions)	
Egg-turning interval		15 " ~ Different from the egg tray	
Capacity		Small egg tray(Included) : Quail egg size 52EA Standard egg tray(Included) : Chicken egg size 20EA Large egg tray(Included) : Goose egg size 10EA Universal tray(Optional) : Various sized egg incubation is available Rolling divider(Optional) : Various sized egg incubation is available	Small egg tray(Included) : Quail egg size 116EA Standard egg tray(Included) : Chicken egg size 48EA Large egg tray(Included) : Goose egg size 24EA Universal tray(Optional) : Various sized egg incubation is available
Power consumption		Average 48W MAX. 65W	Average 65W MAX. 120W
Weight		4.5Kg	6.65Kg
Size		(W)500 × (L)410 × (H)160mm	(W)633 × (L)523 × (H)171mm
Fuse standard		250V 2.0A (Ø5*20mm)	

Extension of free service is not allowed for this product. The warranty period is one year from the date of purchase.

※ How to register the product online:

1. Go to www.rcom.co.kr
2. Click on "English"
3. Sign up for membership first, then log in using those credentials
4. Click "register products"
5. Fill in all required fields and click "Save"
6. Product registration is now completed.

※ Details required to register for the guarantee:

1. The name of the product model
2. The product serial number
3. Your purchase date
4. The name of the store of purchase

● Guide to Consumer Damage Compensation

This product cannot be registered as a free service extension. The warranty period is one year.

Types of Consumer Damage	Compensation History	
	Within warranty period	After the warranty period
In case of naturally occurred failure in function or performance in normal condition of use	Free repair	Paid repair
Failure in function or performance due to intention or error of the customer	Paid repair	
<ul style="list-style-type: none"> ▪ In case of failure due to natural disaster (fire, sea wind, gas, earthquake, storm and flood) ▪ When replacing expendable part normally abraded during the use ▪ Breakdown due to abnormal power source or faulty connection device ▪ Breakdown due to repair or remodelling by person any other than the service engineer of headquarters or the service center ▪ External factors which are not defect of the product ▪ Breakdown due to use of different rating voltage ▪ Breakdown due to use of consumable, optional product not designated by the company ▪ Breakdown or loss due to drop during the transportation ▪ Breakdown for not cleaning the product ▪ Breakdown due to use of other liquid than distilled or purified water ▪ Breakdown due to use of the incubator as brooder device (developer) ▪ Breakdown due to incorrect device control ▪ Breakdown due to manner of use not mentioned in the instruction manual ▪ If the customers' fault is clear 		

 **The success of incubation may vary according to different factors. The manufacturer and distributor are not responsible for failure of incubation of costly eggs, loss of life, property damage due to negligence of user, remodeling, painting, modification of purpose of use or power failure. When incubating parrot or costly birds please verify the internal temperature (adjust) before use. Please read carefully the instruction manual before use to avoid failures.**

Rcom is designed for user's easy and convenient use.
It can be changed without notice for improvement in performance, design,
treatment and software, etc.

Ver.1.35

www.Rcom.co.kr

SELLER

MANUFACTURER

AUTOELEX CO.,LTD.

- OFFICE : 218, Sangdong-ro, Gimhae-si,
Gyeongsangnam-do, 50805 Korea
- TEL : +82-55-337-2561
- E-MAIL : sales@autoelex.com

Choose for the best design, highest quality, value and performance!