

PRO+10 PRO 10 User's Manual

DIGITAL BIRD INCUBATOR Model : PX-10P / PX-10



This manual is produced for common use and may contain images or contents different from the purchased product. In addition, to improve the performance of the product, specifications are subject to change without prior notice.

Rcom



Contents

How to use PRO PLUS 10, PRO 10

1. Introduction	
(1) Introduction on Rcom PRO PLUS 10 & PRO 10	3 ~ 6
(2) Safety Precautions	
(3) Name of each part and basic composition	
(4) Name and function of operational parts	
2. Before use	
(1) What is incubation room?	7 ~ 10
(2) Preparation of incubation / Start incubation	
3. Incubation / Function Settings	
(1) Incubation Modes	11 ~ 18
(2) Start of Automatic Incubation	
(3) Starting Manual (Other birds) Incubation	
(4) How to manually Humidify and Supply Water in Room PRO 10	
(5) Termination of incubation	
(6) Resetting incubation environment during incubation	
(7) Optional function	
(8) How to do Factory Initialization	
(9) Blackout Notification Function	
(10) PRO PLUS 10 : How to forcibly operate humidifying pump	
(11) Candling function	
(12) Humidity and ventilation control during incubation	
(13) Management after hatching / Dew Condensation	
4. How to Clean	
(1) How to separate and clean	19
5. Product Information	
(1) FAQ	20~23
(2) Troubleshooting and measures	
(3) Specification	
(4) Guide on Customers' Damage Compensation	

 **The success of incubation may vary according to different factors. The manufacturer and distributor are not responsible for failure of incubation of costly eggs, loss of life, property damage due to negligence of user, remodeling, painting, modification of purpose of use or power failure. When incubating parrot or costly birds please verify the internal temperature (adjust) before use. Please read carefully the instruction manual before use to avoid failures.**

Mark Explanation



Caution : Caution mark against a fault that can cause damage, trouble, or failure of incubation.



Prohibited.



It is necessary to keep.



Do not disassemble.



Remove the power cord from outlet.



Do not touch.



Ground Connection for preventing electric shock.



Tip : References or useful suggestions in using Rcom product



CAUTION Warning of actions which may be dangerous or cause damage to the incubator.

Rcom PRO PULS 10 & PRO 10

First of all thanks to every customer who purchased our Rcom 10. The Rcom 10 automatically creates and maintains an optimal incubation environment using state-of-the-art technology digital control methods and has been designed for easy and simple use. The Rcom 10 provides the optimal environment, however the user needs to carefully observe and adjust environmental factors such as temperature, humidity, installation location and other conditions necessary for the incubation of different kind of birds Even though the Rcom 10 is designed to provide the optimal setting for every kind of environment necessary for the incubation of eggs, we sincerely suggest you carefully read the instructions before use to allow for the successful incubation and proper use of the device.

Features of Rcom PRO PULS 10 & PRO 10

[MAIN FUNCTIONS]

- * Special mechanism without egg rotation noise. (PRO PLUS) (PRO)
- * Streamlined high quality design in the shape of an egg. (PRO PLUS) (PRO)
- * Clean and transparent large view-window. (PRO PLUS) (PRO)
- * One-touch separation of electronic controller assembly allows convenient cleaning. (PRO PLUS) (PRO)
- * Design incorporates principles to reduce germ reproduction such as minimizing interior mechanisms which reduced the opportunity for bacterial propagation. (PRO PLUS) (PRO)
- * Variable air control lever which enables the interior air volume of the device, to be altered. (PRO PLUS) (PRO)
- * Artificial intelligence based electronics with the state-of-the-art controlling technology designed by Rcom. (PRO PLUS) (PRO)
- * Capacity of simultaneous hatching of 10~15 standard size eggs. (PRO PLUS) (PRO)
- * Rotational Heater Support which enables the easy adjustment of heater tension. (PRO PLUS) (PRO)
- * Air control lever which induces the fresh exterior air minimizing the effects on the insulation. (PRO PLUS) (PRO)
- * Integrated candling facility. (PRO PLUS) (PRO)
- * Automatic egg rotating function (rotating disk method) with adjustable egg rotation timing.(i.e 1h, 2h, 3h) (PRO PLUS) (PRO)
- * Ability to adjust the egg rotation angle. (PRO PLUS) (PRO)
- * Improved reliability based on the application of 3rd Generation Temperature-Humidity Sensor of Sensirion Co. Ltd. (Switzerland). (PRO PLUS) (PRO)
- * Convenient humidification device based on the Automatic Pumping System(APS) for humidification (PRO PLUS)
- * Automatic temperature, humidity adjustment and setup functions. (PRO PLUS)
- * Automatic temperature adjustment and setup functions. (PRO)

[CONVENIENT FUNCTIONS]

- * Clamped structure which prevents the leakage of water drops inside the view-window (dew condensation) out of the device. (PRO PLUS) (PRO)
- * One touch separation of upper part (main controller) for convenient cleaning after incubation and repair. (PRO PLUS) (PRO)
- * External water input hole and moisturizing device for easy supply of water for moisturizing. (PRO PLUS) (PRO)
- * Egg Tray which can simultaneously store different types of eggs. (PRO PLUS) (PRO)
- * Incorporated LED internal lighting. (PRO PLUS) (PRO)
- * Large LCD display which enables the easy view of the diverse information on the device. (PRO PLUS) (PRO)
- * Function of switching Celsius and Fahrenheit degrees. (PRO PLUS) (PRO)
- * Alarm and sign which notices the abnormal temperature (high and low) for suddent change of external temperature. (PRO PLUS) (PRO)
- * Applied Water Nipple for easy supply of water for moisturizing. (PRO PLUS)

※ The PRO model does not include the APS. By installing the additional APS(sold seperately) it can be used as PRO PLUS model.

1. Introduction

(2) Safety precautions

Electrical hazards

CAUTION Be careful the details below when you use.



Do not use a damaged power cord or loose outlet.
▶ Risk of electric shock or fire.

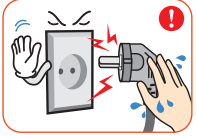

Do not pull the cord when taking out the power cord, and keep wet hands away from connecting plug.
▶ Risk of electric shock or fire.

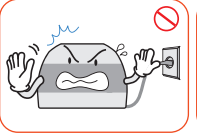

Never pull the plug out of the outlet during the incubation period.
▶ Incubation will be interrupted.

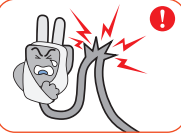

Do not twist or crush electric cord.
▶ Risk of electric shock or fire.

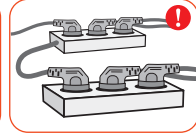

Do not insert multiple connecting plugs in an outlet.
▶ Risk of fire or electrical overload.

Setting Cautions

CAUTION Be careful the details below when you use.



Do not install the product in dusty or unclean places.
▶ If the dust or any alien substance is introduced to the interior they may cause electric shock or fire.

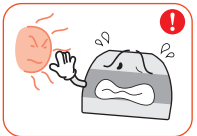

Do not install the product under direct sunlight.
▶ It may cause electric shock or fire.



Do not install the product in wet or moist places.
▶ If the water is introduced to the interior it may cause electric shock or fire.



Avoid too cold or hot place and do not dispose the product near candles, mosquito coil, cigarette fire or any heating equipment.
▶ It may cause fire.



Do not use any other part than assigned ones.
▶ It may cause breakdown or failure of incubation.



Do not block the ventilation hole with cover.
▶ Lack of ventilation may cause an increase in internal temperature and result in breakdown or fire.



Do not have any heating device near the power cord.
▶ When the cord sheath is melted it may cause fire or electric shock.

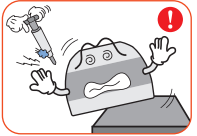

Do not place on a moving shelf, inclined place, unstable place or any place with severe vibration.
▶ Product may fall resulting in breakdown or damage. The vibration may reduce the product life or cause fire.



Do not overturn the product.
▶ The water within the main body may pour onto electronics or the sight glass may be damaged.

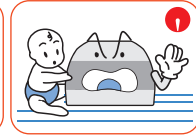

Do not let a child assemble the product. Must be assembled by a competent adult.

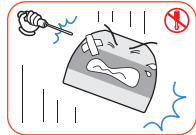

Do not arbitrarily disassemble, repair nor modify/remodel.
▶ It may cause electric shock or fire. When you need repairs please contact to the service center.



Supervise children near product. Do not to introduce any metal object, nail, clip or egg shell to the external hole of the device.
▶ It may cause electric shock, fire or injury.

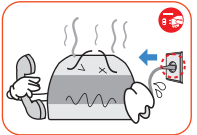

If the device produces any abnormal sound or smoke please immediately disconnect the power plug and contact to the service center.
▶ It may produce electric shock or fire.



When not using the device for long time, please disconnect the power plug, clean, dry and maintain it properly.
▶ The accumulated dust may produce electric shock, power leakage or fire due to heating, ignition or deterioration of insulation.

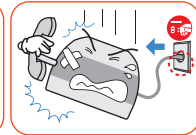

When dropped or damaged the product case, disconnect the power plug and contact to the service center.
▶ When used in that condition, it may cause electric shock or fire.

Cleaning Cautions

CAUTION Be sure to disconnect the electric cord from the outlet before cleaning.



Do not spray the detergent directly to the exterior part of the device.
▶ It may increase the possibility of discoloration, peeling of printed part, etc when directly sprayed.



Please wipe the product with smooth cloth and neutral detergent.



If there is any dust in the pin or accessing part of the power plug, please clean it with dry patch.
▶ If not, it may cause electric shock or fire.



When cleaning please disconnect the power cord and polish the device with a smooth, clean cloth.
▶ Do not use any chemical product as wax, benzene, thinner, mosquitoicide, air freshener, lubricant, detergent, etc.



Please contact the service or customer consultation center at least once a year for device check-up.
▶ The dust accumulated for long time in the interior of the product may produce fire or breakdown.

1. Introduction

(2) Name of each part and basic composition

Name of each part

- ① Serial no.
- ② Main Controller
- ③ LCD
- ④ Ventilation Control Lever
- ⑤ Candling Zone
- ⑥ Handle
- ⑦ View Window
- ⑧ Turning Disk
- ⑨ Humidification Nipple
- *Nipple is separately sold from Rcom 10
- ⑩ Egg Tray
- ⑪ Bottom Body
- ⑫ Water hole for manual humidification
- ⑬ Manual egg turning handle
- ⑭ Automatic pumping system(APS)
- *APS is separately sold from Rcom 10

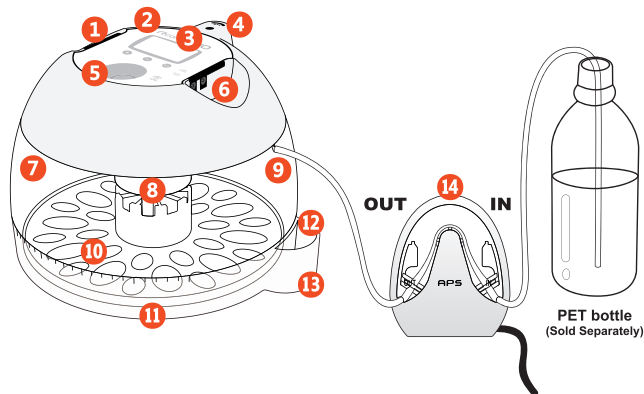

Basic Composition

- * The Serial No. of the product is noted on the left side of the main controller.
Please do not damage it. (Ex:H10MX0000000000)
- * The air filter (1 set: 5 units) and humidity pad are sold separately.

Main Controller	View Window	Turning Disk	Egg Tray	Bottom Body	
	 * Insert Air filter 3days before hatch.		 * It is cut and shipped assembled in the view window.	 * It comes assembled in the view window.	
Adaptor, Power Cord	Air filter	Manual	Humidity Pad	Nipple	APS Set

*The Pro model does not include the Humidity Pad and Nipple, APS.
By installing the additional APS(Sold Separately) it can be used as PRO PLUS model.

Composition of Automatic Pumping System (APS)

- ① Pump Body
- ② Pumping gear (Motor)
- ③ Nipple holder (Both sides)
- ④ Cap
- ⑤ Silicon Tube and Nipple (2pcs.)
- ⑥ Silicon Tube 1.5m (Diameter : Ø2.6 × 3.5)
- ⑦ APS Power Cable

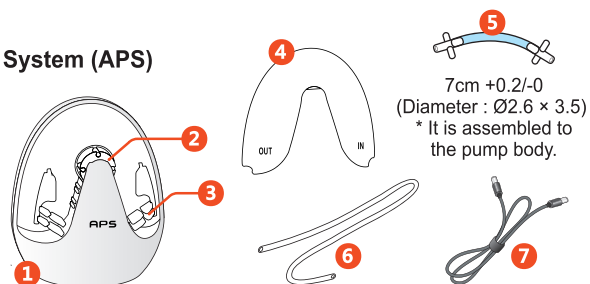

1. Introduction

(3) Name and function of operational parts

Name and function of operational parts

- ① Display (LCD) : Shows the incubation environment.
- ② Automatic Pumping System (APS) connection socket : It is the socket which connects the APS to the device.
- ③ Power adaptor connection socket : This socket allows power into to the device.
- ④ Up button : Used to select menu or to increase value.
- ⑤ Down button : Used to select menu or to decrease value.
- ⑥ Menu selection button : Button to save setup values.
- ⑦ Candling button / Back button : Used to turn ON/OFF the candling function or to go back to previous step in setup selections.
- ⑧ Candling zone : Used as candling device by pressing the Candling button.

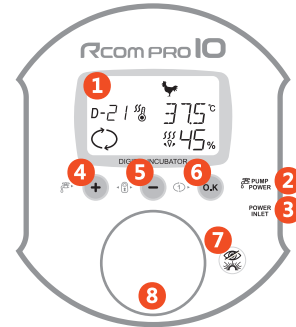

⚠ Do not look directly into the LED light.

	Factory Default Reset : The reset can be done by pressing 2 buttons at the same time for 1 seconds (only during incubation)
	Option setup : The option can be setup by pressing 2 buttons at the same time for 3 seconds.
	Menu selection / Egg rotation test / Setup value verification during incubation.
	Increase value / 5 seconds : forcible pump operation / 10 seconds : forced pump operation for 2 minutes.
	Decrease value / Termination of incubation.
	While the button is pressed the candling function is turned on. When setup menu : moves to previous step.

ICON	Name and function	ICON	Name and function
	Chicken ↔ Pheasant ↔ Other birds ↔ Quail ↔ Duck (according to above order)		Shows operating Egg rotation
			Shows Egg rotation suspended
			Shows Terminated Egg rotation
	Days until hatching		Show Temperature / Optional function
	Shows Heater OFF/ON		Shows humidity units
	Shows Humidification OFF/ON		Shows humidity value
	Shows unit of Celsius / Fahrenheit		Shows blackout notification

※ Explanation on Optional Functions (Refer to 15~16P)

1. T.CA	⚠ It is not recommendable direct adjustment by user. Please contact agent or supplier.
2. H.CA	⚠ It is not recommendable direct adjustment by user. Please contact agent or supplier.
3. HI	Sounds alarm when the incubator temperature is higher than setup value, due to external environmental change or other anomaly. [Default value : 2.0°C]
4. LO	Sounds alarm when the incubator temperature is lower than setup value due to external environmental change or other anomaly. [Default value : -3.0°C]
5. COOL	Cools during the setup time among the 24 hours of a day [Default value : 0h(hour)]
6. C/F	Modification of Celsius (°C), Fahrenheit (°F) degrees [Default value : Celsius (°C)]
7. B.Lt	LCD back light ON/OFF/EVENT ON setup [Default value : ON]
8. In.L	Device's interior lighting ON/OFF setup [Default value : ON]
9. Snd	Device's button sound ON/OFF setup [Default value : ON]
10. Info	Shows the basic information of this device. (Shows version information)

2. Before use

(1) What is incubation room?
(2) Preparation of incubation / Start incubation

What is Hatching room?

What is a hatching room? This is the location where the incubator is installed and operated. As the environment affects the hatching rate the place of installation must be a place with low nearby noise or vibration, and nearby temperature must be 22~25°C (71.6~77°F) with low temperature difference. Especially in night time the temperature is lowered than daytime therefore it surely must be verified, and in daytime the device must never be exposed directly under the sunlight. Also the place must not have direct ventilation as air conditioner to the device.

Preparation / Start of Incubation

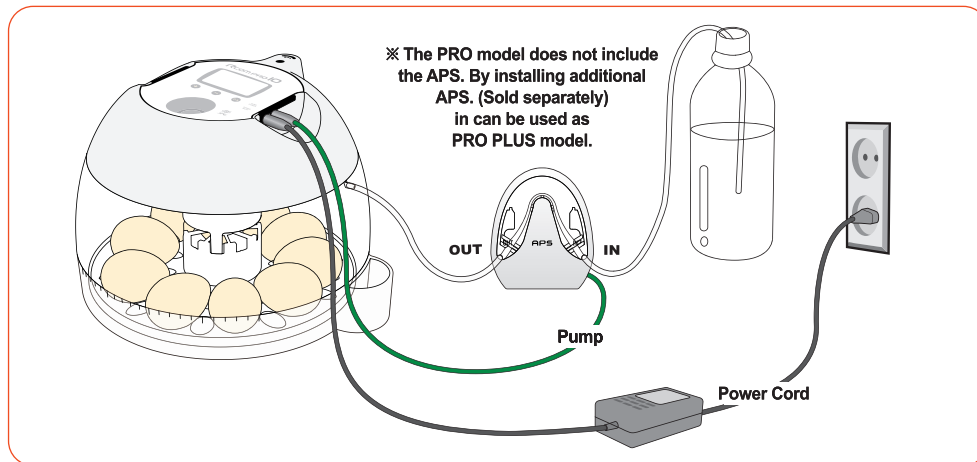

- ▶ Separate each part for assembly and verify if there is any missing or damaged parts. Please do not discard the product box, use it to store the product safely.
- ▶ There is a Serial NO. of the left side of the main controller's handle. Reference the details in the Rcom home page. [www.Rcom.co.kr → Register Product]

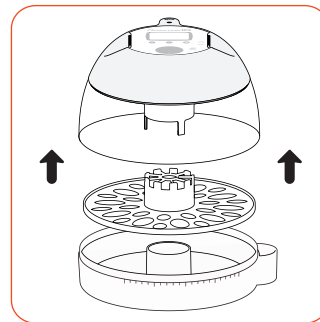

2. Before use

(2) Preparation of incubation / Start incubation

- ▶ The humidity is fitted between the main controller and view window. See the right, the humidity pad is already installed for the first use after purchase.

- ⚠ The maximum/minimum humidification capacity varies according to the size of the humidification pad.

The life of humidification pad is 4~6 months under normal usage conditions but if the water quality is improper the life might be reduced. (Please use distilled or purified water for moisturizing.)

The humidification pad can be purchased separately.

- ▶ To disassemble the humidity pad, please refer to [4. How to Clean] page.

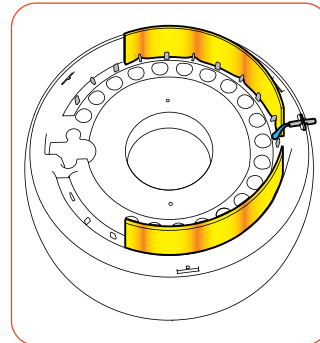

- ▶ Please insert air filter into the lower groove of egg turning disk as shown in the picture 3day before hatching.

- ⚠ Please wash the air filter before use, as dust in the air filter during use this may disrupt proper air circulation.

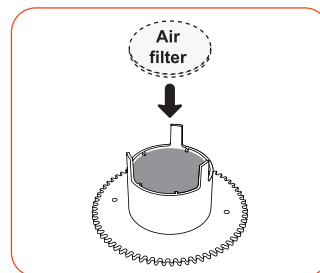

- ▶ It is recommended to sterilize both the eggs and the incubator interior before loading the eggs. [Reference Rcom Antiseptic Solution] Assemble the main body (lower part) and tray and place the eggs in, adjusting the location according to egg size.

- Tip It is recommended to locate the sharper point of the egg to the inner side of the device.

- ▶ Place the eggs and close the view-window.

- ⚠ If the view-window is not completely closed the temperature will not increase.

- ⚠ Turn the device on before placing the eggs thus verifying all the functions are performing normally, then start the incubation once verified.

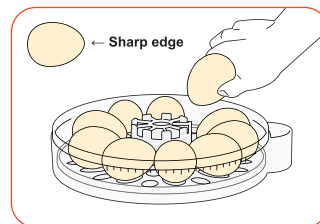

2. Before use

(2) Preparation of incubation / Start incubation

- ▶ Open the cap of the APS body.
- ▶ Remove the silicon tube & nipples from the APS body.

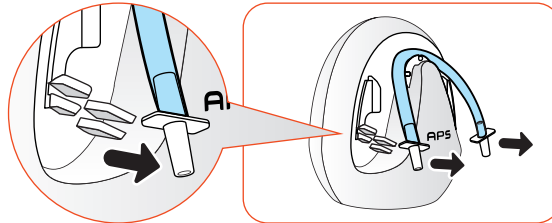

- ▶ Cut the silicone tube to 0.5m and 1m lengths. Attach the cut parts of the silicone tube onto the nipples on either side of the APS unit.

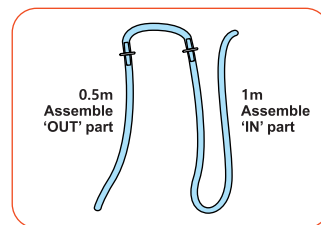
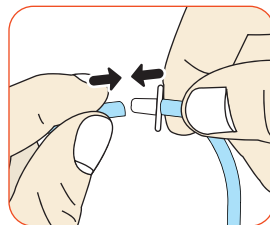
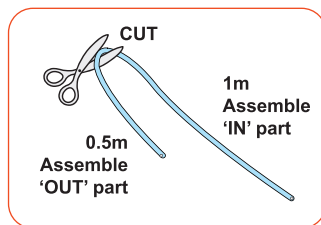

- ⚠ The silicone tube may become folded, causing a blockage. Please ensure that any blockages are removed by gentle pulling both ends of the tube before assembly.
- ⚠ Please note that pumping performance will be reduced if the silicone tube isn't fitted tightly onto the nipple, or if the tube length is different.

- ▶ As shown in Picture, insert a nipple, attached to 0.5m silicone tube, into the 'OUT' part (left-hand side) of the nipple holder.

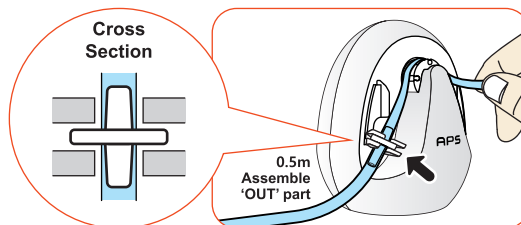

- ▶ As shown in Picture, insert a nipple, attached to 1m silicone tube, into the 'IN' part (right-hand side) of the nipple holder. (As for this part, short one is normal and it should be taut when installing)

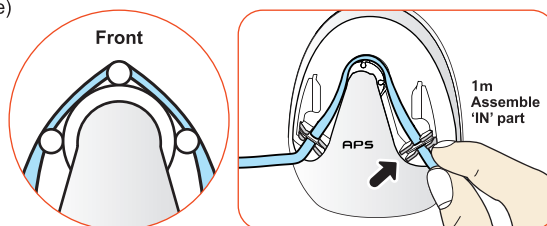

- ▶ Assemble the cap onto the pump body. Please make sure silicone tubes do not get jammed in the cap.
- ▶ Connect the APS power cable onto the power inlet at the back of the pump body.

2. Before use

(2) Preparation of incubation / Start incubation

Tip As shown, water flows out of the left silicon tube, and comes into the right silicon tube.

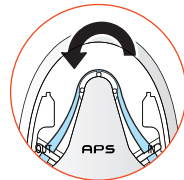

Turning direction of the motor

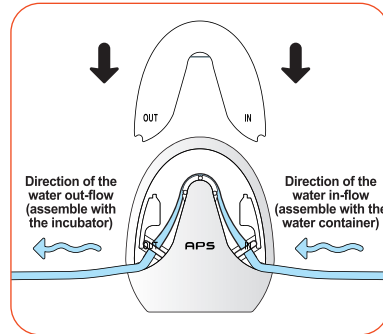

- ▶ If the silicone tube wear out and it does not pump water effectively, you should replace silicone tube.

⚠ Be sure to use the silicon tube supplied from Autoelex(Rcom). (Ø2.6mm × 3.5)

Tip If water does not flow out even if pumping motor is working, check if silicon tube is blocked or folded.

- ▶ Insert the power cord and APS(pump power*) jack to the upper side of the product.
(*Pump pack and/or Rcom PRO PLUS 10 model sold separately.)

⚠ Please pay special attention and do not to switch the location of power cord and APS(pump power) jack.

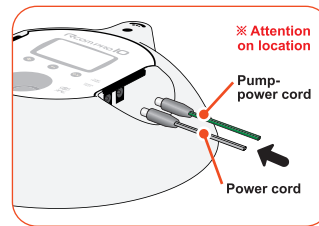

[In case of PRO PLUS 10 model]

- ▶ Connect the OUT side silicone tube of the automatic pumping system (APS) to the nipple of the device, and put the silicone tube of IN side to the PET water bottle.

In case of PRO PLUS 10 model do not pour water to the water hole in the lower part of the main body as it includes automatic pumping system (APS).

⚠ If the silicone tube is not exactly inserted the pumping may not work properly. Never shake or reverse the main body of the device after filling the water. Any spilled or leaked water may cause device breakdown.

⚠ Please place the incubator, APS pump, and water bottle on a level surface and at a similar height. The recommend height of the water bottle is 250mm.

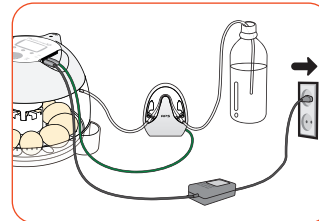

[In case of PRO 10 model]

- ▶ Pour the water into the water hole of the lower part of the main body. The silicone hose will supply water to the interior of the incubator. Pay special attention to prevent overflow. During incubation please verify daily if there is water in the water hole and when insufficient please supply water.

In the PRO 10 model, the APS is sold separately. It can be purchased and installed as the PRO PLUS 10 model. When the APS is installed, do not pour water to the water hole in the lower part of the main body.

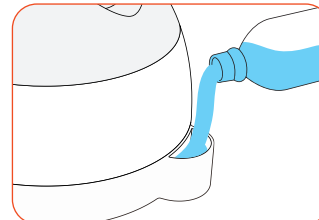

Tip It takes a little time for the water reaches the internal part of the device.

3. Incubation / Function Settings

(1) Incubation Modes
(2) Start of Automatic Incubation

Incubation Modes

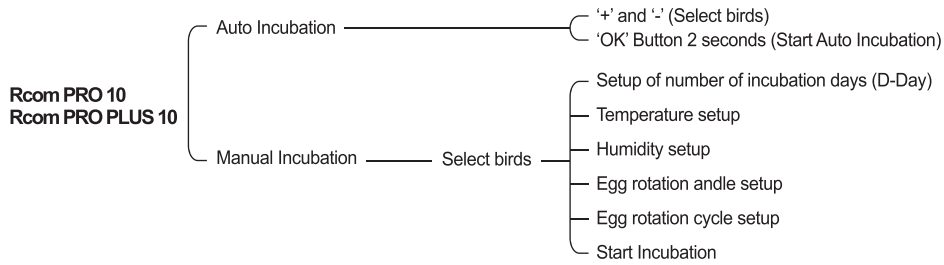

- ▶ When pressed Candling Sign (Button) during the Menu Setup the user may go back to the previous step.

Start of Automatic Incubation

- ▶ When connecting the power plug to socket the LCD display turns on and the device starts to work.

 It may smell a little in first operation however this is normal.

- ▶ The Bird icon on the LCD display flickers and it switches to different types of bird by pressing + or - button. Select the type of bird to incubate.
- ▶ After choosing the type of bird to incubate, keep pressing the OK button approximately 2 seconds when the icon flickers, then the internal lighting of the incubator turns on with a Beep~ and the devices starts the operation.
- ▶ Incubator conditions are automatically and optimally adjusted. Choosing the type of bird will set the proper incubation conditions as temperature, humidity and rotation are automatically controlled and the user may modify the incubation condition when necessary.
- ▶ The setup numbers are reached in about 1~2 hours after initiating the device.

※ As the device controls the internal temperature checking the external environment due to artificial intelligence, therefore it may raise the temperature very slowly in some sections.

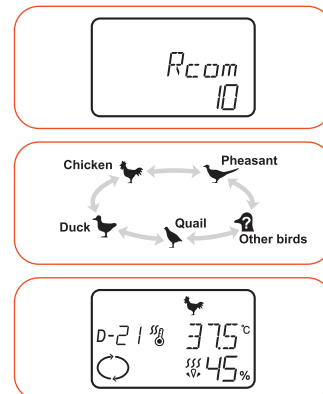

3. Incubation / Function Settings

(3) Starting Manual (Other birds)
Incubation

Starting Manual (Other birds) Incubation

- ▶ This is a function where the temperature, humidity and egg rotation can be arbitrarily setup by professionals skilled in incubation.
- ▶ In the initial display choose Other birds by pressing + or - button and press OK to enter to the setup mode.
- ▶ The temperature setup, humidity, egg rotating angle, rotation cycle can be setup with + and - buttons and the setup values are saved by pressing the OK button.

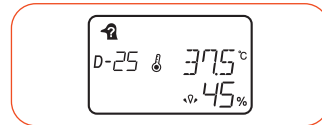

[Setup of number of incubation days (D-Day)]

- ▶ DAY(number of hatching days) and D-25 are shown. Setup the desired number of days with + and - button and press OK to move to temperature setup phase.
[Adjustment scope : 1 ~ 50 days]
[Default value : 25 days]
- ▶ If Candling sign(button) was pressed during setup you can go back to previous step.
- ▶ How to setup continuous incubation function :
In D-Day(number of hatching days) setup use the + button and increase until D-50Days and press + again and "--" sign is shown, and by pressing OK button it is setup as continuous incubation function.

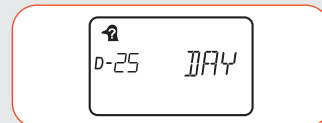
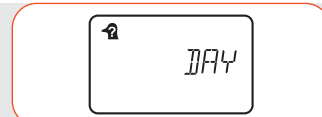

What is Continuous Incubation Function Setup?

It is a function which enables the continued operation of the device with the currently setup incubation conditions regardless of number of incubation days.

[Temperature setup]

- ▶ TEMP (temperature) is briefly shown and 37.5°C sign flickers. Setup the desired temperature with + and - button and press OK to move to humidity setup phase.
[Adjustment scope : 20 ~ 42°C (68 ~ 107.6°F)]
[Default value : 37.5°C (99.5°F)]
- ▶ If Candling sign (button) was pressed during setup you can go back to previous step.

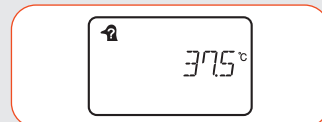

3. Incubation / Function Settings

(3) Starting Manual (Other birds)
Incubation

[Humidity setup]

- ▶ HUMI(humidity) sign is briefly shown and 45% sign flickers. Setup the humidity with + and - button and press OK to move to egg rotation angle setup phase.
[Adjustment scope : RH 20 ~ 70%]
[Default value : RH 45%]
- ▶ When the humidity is setup below RH 20% the OFF sign indicates humidification function is turned off.
- ▶ If Candling sign (button) was pressed during setup you can go back to previous step.



HUMI



HUMI
45%

Tip The setup humidity turns to RH 65% from 3 days before hatch. This is automatically programmed feature to help hatching and not a fault of the device.

Tip The temperature and humidity are optimally adjusted according to international standards when launched from factory. When necessary it can be reset but it is not recommendable to be directly adjusted by the user. When reset is necessary please contact Rcom web site (www.Rcom.co.kr→Data base→Instruction manual category) or to the place where you purchased the product. The low price thermometer and hygrometer easily procurable in markets can be inaccurate in measurement value and may need frequent calibration, therefore please use the exclusive thermo-hygrometer for birds. [Thermo-hygrometer exclusive for birds - Reference www.Rcom.co.kr]

[Egg rotation angle setup]

- ▶ ANGL(Egg rotation angle) is briefly shown and 10s(seconds) sign flickers. Setup the desired egg rotation time with + and - button and press OK to move to egg rotation cycle setup phase.
[Adjustment scope : 0 ~ 60s(seconds) in 1 second as a unit, when setup as RND it shall be operated randomly]
[Default value : 10s(seconds)]
- ▶ If Candling sign (button) was pressed during setup you can go back to previous step.



ANGL

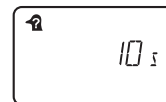

10 s

[Egg rotation cycle setup]

- ▶ INTV(Egg rotation cycle) is briefly shown and the 60m(minutes) sign flickers. Setup the desired cycle with + and - button and press OK to save setup value and initiate incubation.
[Adjustment scope : 10 ~ 360m(minutes) by scale of 10 minutes]
[Default value : 60m(minutes)]

Tip The egg rotation is suspended 3 days before hatch. This is automatically programmed to help hatching and not a fault of the device.

- ▶ If Candling sign (button) was pressed during setup you can go back to previous step.

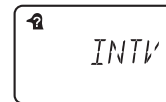

INTV

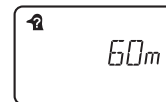

60m

3. Incubation / Function Settings

(4) How to manually Humidify and Supply Water in Rcom PRO 10
 (5) Termination of incubation
 (6) Resetting incubation environment during incubation

How to manually Humidify and Supply Water in Rcom PRO 10

- ▶ Pour water into water hole of the main body (lower part).
The connected silicone hose will supply water to the interior.
- ▶ Verify daily if there is water in the water hole during incubation and supply when insufficient.
- ▶ When desiring to incubate on low humidity only fill the internal water chamber A connected to the water hole.
[RH 45% or less]
If the humidity of hatching chamber is higher than setup value please open the air control lever to adjust it.
- ▶ When desiring to incubate with high humidity, please fill all the A and B water chambers with water. [RH 45% or over]
Adjust humidity 3 days before hatch.
If the humidity is lower than setup value please close the air control lever.

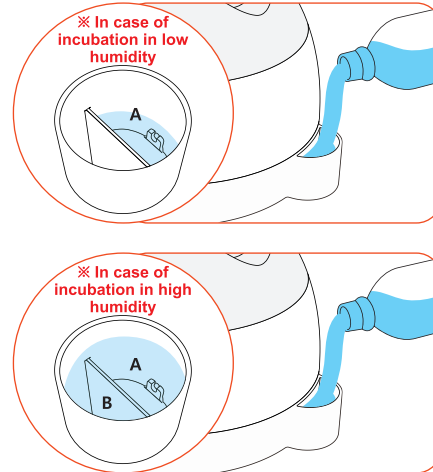

Termination of incubation

- ▶ During incubation '-' button press the for 3 seconds and the incubation is terminated and moves to initial step/status.

Resetting incubation environment during incubation

- ▶ Press the + and - buttons at the same time during incubation to Reset incubation environment and the temperature sign flickers.
- ▶ When modifying the temperature readjust the value with + and - buttons, press OK button and the setup value is saved and it moves to next step (temperature, humidity, egg rotation, egg rotation cycle, cooling control cycle setup).
- ▶ If Candling sign(button) is pressed during setup you can go back to previous step. Also the display switches to incubation display if a button is not pressed during 10 seconds.



High/Low temperature Alarm function (optional function)

Tip What are Abnormal High/Low Temperature Alarm functions?
 It is an [Alarm Function](#) which notifies the user when the device's interior temperature is abnormally high or low.

- ▶ The alarm sounds in case of abnormal temperature and the display shows the current temperature and consequently whether it is high or low according to the setup value.

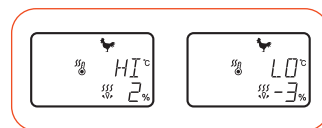

⚠ The alarm sounds for 1 minute and automatically stopped, and the alarm sign is consequently shown until the OK button is pressed. (Ex : In case of alarm for 2°C HI it consequently shows the current temperature and +2.0 / In case of -3°C LO alarm it consequently shows current temperature and -3.0.)

3. Incubation / Function Settings

(7) Optional function

[How to setup Abnormal High Temperature Alarm]

※ It is an alarm function which notifies when the device's interior temperature is higher than setup value.

- ▶ Setup scope : 0.0 ~ 5.0°C (0 ~ 5°F) [Default setup value : 2°C]
- ▶ By pressing the + and OK buttons for 3 seconds at the same time the OPTN(option) sign appears.
- ▶ By pressing + or - button select 3.HI and press OK to go back to Abnormal High Temperature Alarm setup.
- ▶ By selecting the alarm value with + or - button and pressing OK, the setup values are saved.
- ▶ If pressed Candling sign(button) during setup you can go back to previous step.

3 HI

[How to setup Abnormal Low Temperature Alarm]

※ It is an alarm function which notifies when the device's interior temperature is lower than setup value.

- ▶ Setup scope : 0.0 ~ -5.0°C (0 ~ -5°F) [Default setup value : -3°C]
- ▶ By pressing the + and OK buttons for 3 seconds at the same time the OPTN(option) sign appears.
- ▶ By pressing + or - button select 4.LO and press OK to go back to Abnormal Low Temperature alarm setup.
- ▶ By selecting the alarm value with + or - button and pressing OK, the setup values are saved.
- ▶ If pressed Candling sign(button) during setup you can go back to previous step.

4 LO

Cooling control cycle setup (optional function)

- ▶ By pressing the + and OK buttons for 3 seconds at the same time the OPTN(option) sign appears.
- ▶ By pressing + or - button select 5.COOL and press OK to go back to cooling control cycle modification mode.
- ▶ By selecting the cycle with + or - button and pressing OK, the setup values are saved.
[Adjustment scope : 0 ~ 6h(hours) in 1 hour as a unit]
[Default value : 0h(hour)]

5 COOL0h

 **Tip** What is COOL(cooling control) Function? It is a function which cools during the setup time among the 24 hours of a day. The periodic cooling is helpful for successful hatching but you might need preliminary knowledge to perform the cooling control process.

- ▶ If Candling sign (button) was pressed during setup you can go back to previous step.

How to switch between Celsius ↔ Fahrenheit degrees (optional function)

- ▶ By pressing the + and OK buttons for 3 seconds at the same time the OPTN(option) sign appears.
- ▶ By pressing + or - button select 6.C/F and press OK to go back to Celsius/Fahrenheit modification mode.
- ▶ When pressed OK after selecting °C = Modified to Fahrenheit degree.
When pressed OK after selecting °F = Modified to Celsius degree..
[Default value : °C]

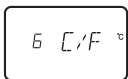
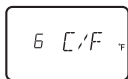
6 C/F6 C/F °C6 C/F °F

 **Tip** °C = 5/9 (°F - 32)

- ▶ If pressed Candling sign(button) during setup you can go back to previous step.

3. Incubation / Function Settings

(7) Optional function

Back light ON↔OFF↔EVENT ON method (optional function)

- ▶ By pressing the + and OK buttons for 3 seconds at the same time the OPTN(option) sign appears.
- ▶ By pressing + or - button, select 7.B.Lt and press OK to go back to Back Light setup.
- ▶ By selecting ON, OFF or EVENT ON with + or - button and pressing OK the setup values are saved. When setup as EVENT ON the back light is only turned on for 30 seconds when the button is pressed or the alarm is produced. [Default value : ON]
- ▶ If pressed Candling sign(button) during setup you can go back to previous step.

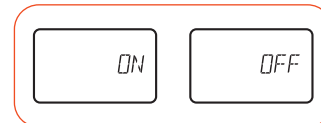
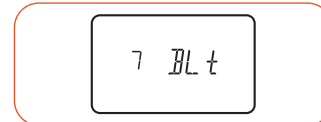

How to ON↔OFF Interior Lighting (optional function)

- ▶ By pressing the + and OK buttons for 3 seconds at the same time the OPTN(option) sign appears.
- ▶ By pressing + or - button select 8.I.nL and press OK to go back to Interior Lighting setup.
- ▶ By selecting the ON or OFF with + or - button and pressing OK, the setup values are saved. [Default value : ON]
- ▶ If pressed Candling sign(button) during setup you can go back to previous step.

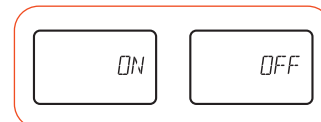
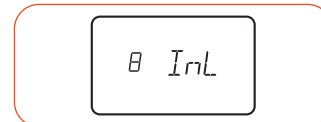

How to ON↔OFF SOUND (optional function)

- ▶ By pressing the + and OK buttons for 3 seconds at the same time the OPTN(option) sign appears.
- ▶ By pressing + or - button select 9.Snd and press OK to go back to Sound setup.
- ▶ By selecting the ON or OFF with + or - button and pressing OK, the setup values are saved. [Default value : ON]
- ▶ If pressed Candling sign(button) during setup you can go back to previous step.

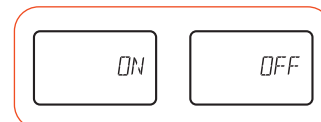
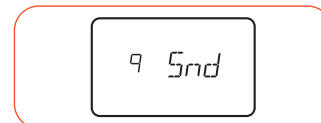

Information display (optional function)

- ▶ By pressing the + and OK buttons for 3 seconds at the same time the OPTN(option) sign appears.
- ▶ Select the 10.I.nfo by pressing + or - button and press OK to display basic information of the device.

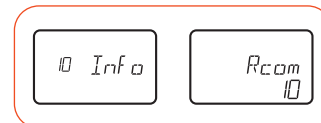

How to leave Optional Function

- ▶ By pressing the + and OK buttons for 3 seconds at the same time the OPTN(option) sign appears.
- ▶ Press + or - button, select 11.ESC and press OK and you can exit from the optional function setup.

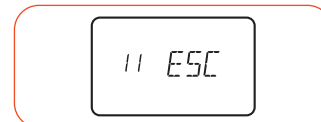

3. Incubation / Function Settings

(8) How to do Factory Initialization (9) Blackout Notification Function
(10) PRO PLUS 10 : How to forcibly operate humidifying pump
(11) Candling function

How to do Factory Initialization

- ▶ When the input values are incorrect, use factory default function to initialize the device to the initial status launched from the factory.
- ▶ When inserted the power by pressing the OK button at the same time, the RST sign is displayed and the device is initialized as in factory. (Modified to default status)



Blackout Notification Function

- ▶ During the incubation the power sign in display flickers and sounds the alarm for 10 seconds. When pressed OK button it is suspended and the power sign is immediately disappears.



PRO PLUS 10 : How to forcibly operate humidifying pump

- ▶ The pump motor may be tested by pressing the + button for 5 seconds during operation.
- ▶ The pump motor may be tested for 2 mins by pressing the + button for 10 seconds during operation. In this moment the pump motor works even the button is not pressed directly.

Tip If you press any button during the consecutive 2 minutes operation, the pump operation is immediately suspended.

Candling Function

Tip Candling allows observation of the fertilized, unfertilized, suspended hatching or development of embryo, and if there is any minute fissure on the egg after introducing to the incubator the germs penetrate into it therefore the decomposition starts. As the decomposed egg may contaminate other eggs, it is recommendable to perform candling in dark environment to select the proper ones.

⚠ Do not directly look into the LED light except in case of candling (egg examination).

- ▶ The environment for candling must be dark for easier observation.
- ▶ Pull up carefully the main controller and the handle of main body (upper part) and take the egg to examine/candle.
- ▶ Place the wide, round part of the egg onto the candling zone of the main body (upper part), press the Candling button and observe the interior of the egg (embryo or blood vessel). The light will turn on 0.5 seconds after pressing the button for safety.

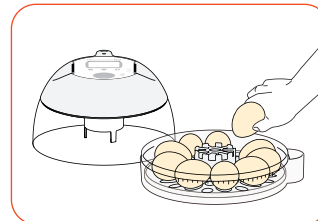

⚠ The candling can be verified by naked eye from 5~7 days after initiation of incubation, and if the blood vessel or embryo (chick) is not observed the egg may be unfertilized therefore remove it from the incubator. If the egg shell is thick or dark it may be difficult to verify with naked eye. White eggs as duck eggs are easier to observe.

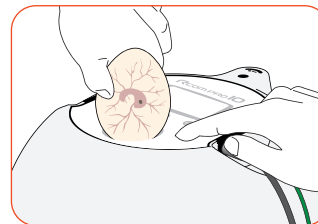
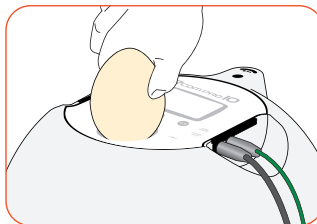

⚠ It is not recommended to candle over 10 minutes within a warm indoor environment.

Please pay special attention not to apply any impact on the egg. The egg may die due to stress caused by severe shaking or turning.

Tip Too frequent candling may cause failure to hatch.

3. Incubation / Function Settings

(12) Humidity and ventilation control during incubation
(13) Management after hatching / Dew Condensation

Humidity and ventilation control during incubation

- ▶ Humidity must be maintained before hatching to prevent drying of egg shell or non hatch.
 - ▶ It is not recommended to open the cover frequently in the hatching period. If the cover is frequently opened the humidity is rapidly reduced and it may take long time to recover the humidity again.
 - ※ If the internal temperature of the device is 37°C (98.6°F) or over, and the temperature of hatching room is lower then humidity may not reach RH 65%. There might be ±5% of tolerance in humidity and there is no significant problem for hatching.
 - ▶ The humidity control is important in 1-2 days before hatching than in the beginning and in the middle of incubation, the moisture must be maintained from 1-2 days before hatching. In case of water bird the humidity during incubation must be RH 45~55% / in case of poultry RH 40~45% / parrots RH 35~45% generally and for every type of bird the humidity for a day before hatching must be RH 65% or over.
 - ※ Air control lever (Air Vent) : It may induce the fresh exterior air minimizing the effects on the insulation.
Please open all the air control levers (Air Vent) when the egg breaking begins.
- 
- Tip** Verify once every 3 days during the incubation if the water is low, then supply water, and it is recommended to use distilled or purified water than water from water purifier, softener or underground water to maintain performance.
- ※ The humidity pad is consumable and it can be purchased.

Management after hatching

- ▶ Hatching within the incubator can cause a build up of germs with possible cross contamination of bacteria, and the dust, feather dander, egg shells and excrement may produce a breakdown of the incubator which is not covered under warranty. Please consider the Rcom Suro eco hatcher specifically for hatching. Please reference the web site (www.Rcom.co.kr→Download→Incubation Common Sense) for simple developer chamber instructions or we recommend to use the KINGSURO Brooder of our company.
- ⚠ Do not brood the chick within the incubator. Have a radiant heat brooder for chicks that are dry and fluffy. As it can be the cause of breakdown and produce paid repair (A/S) cost even within warranty period. (Please move the chick to the brooding chamber after hatching.)
- Tip** Generating chamber: It is a space for hatching (egg breaking) used 1~3 days before hatching. (Rcom KINGSUR BROODER)
Developing (brooder) chamber: It is a space (device) which adapts the just born chick to the environment by maintaining proper temperature and humidity. (Rcom KINGSUR BROODER/Rcom BIRD BROODER&ICU)
- ▶ As the feed for little birds may vary by type, it is recommendable to acquire prior understanding on the bird before hatching. (Please use the information on birds in the Rcom web site.)

Dew Condensation

- ▶ When operating the device, if the difference between exterior and interior temperature of the device is high, the dew condensation is naturally occurred therefore there is no operational problem due to this phenomena.

4. How to Clean

(1) How to separate and clean

How to separate and clean

⚠ Please separate the power cord from the socket.

▶ When immediately turned off the device in high humidity incubation and left with the cover closed, the humidity remaining inside the device may evaporate, adhere to the device and product breakdown. Always open the view-window and eliminate the inner humidity to use the device in the most safe manner. Incubator must be completely dried out before storage.

▶ Also disconnect the device and the adaptor cord.

▶ There are 3(three) screws connected to the main controller inside the view-window. Please disassemble the main controller and view-window by loosening 3(three) screws with a screwdriver.

▶ Eliminate carefully with brush the dust on the separated main controller. At this point, do not apply any strength on the sensor or heater.

▶ The humidity and temperature sensor units are connected with the connector to be easily replace in case of breakdown.

▶ Wipe the view-window, egg rotation disk, tray, air filter and the main body (lower part) down properly with lukewarm water.

▶ Do not was the Automatic Pumping System (APS) with water but wipe with clean fabric.

▶ Please remove the water in the silicon tube of the APS and leave to dry completely.

▶ If storing the APS for a long time, the silicon tube may become blocked or stuck. So before storage, remove the tube from the pump body, dry it out and ensure the tube is not twisted or folded. Upon reassembly, the tube may have blockages or folds. Ensure these are opened up by massaging the tube in the affected areas or flushing it with water.

▶ Wipe the exterior with smooth fabric, dry in a fresh place with proper ventilation and assemble in order reverse to the disassembly and store properly.

Tip When assembled, the grooves of air control lever and view-window should line up.

⚠ Do not clean the product with organic solvents as benzene and thinner. It may deform or discolor the product.

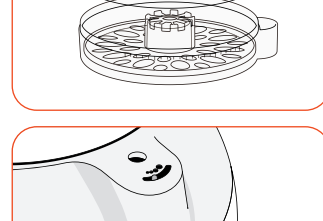
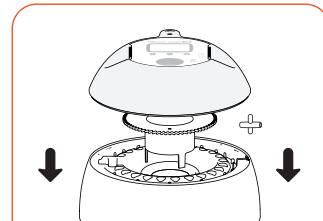
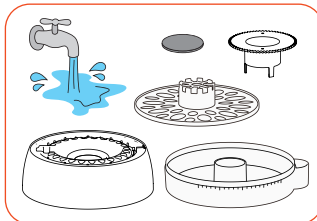
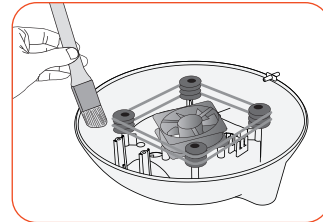
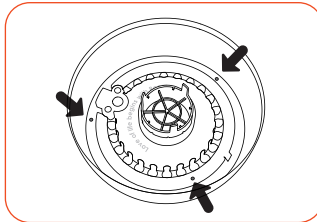
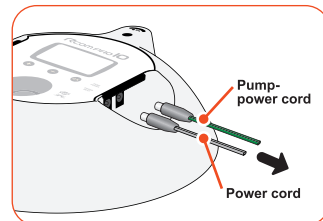
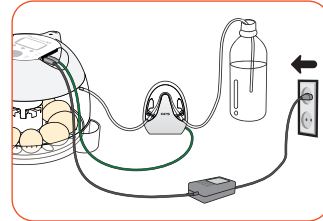

5. Product Information

(1) FAQ

FAQ

The Rcom products are manufactured under strict quality management with precise equipments, but there may be some defects in the product during the distribution. If there is any problem please contact to the Service center or Distributor of Rcom. We will do our best to resolve the problem as soon as possible. The product is designed in module methods which is easily replaceable by any qualified person.

* E-mail reception : sales@autoelex.com

Symptom	Estimated cause (possibility)	Solutions
If the average hatching rate is low	<ul style="list-style-type: none"> ▶ If the egg is unfertilized ▶ Germ infection ▶ Incorrect incubation setup ▶ Health condition of the mother bird ▶ Improper egg rotation ▶ When the vibration or noise is severe near the device ▶ When the air filter's cleaning condition is improper ▶ Improper egg storage status, when passed over 1 week after spawning 	<ul style="list-style-type: none"> ▶ Candle the egg to verify if it's alive ▶ Sterilize the device ▶ Check all the setup process of the device. Especially on the temperature. ▶ Care the mother bird's health. ▶ Verify if the egg rotation is normally performed. ▶ Move the device to a place without noise or vibration. ▶ Clean the air filter. ▶ Store the egg under low temperature of 20~25°C or less and use eggs within 1 week after spawning.
If the chick is born earlier than the estimated date or when is malformed	<ul style="list-style-type: none"> ▶ If the setup temperature is too high. ▶ If the egg rotation is not performed. ▶ In case of unhealthy hatchery egg. 	<ul style="list-style-type: none"> ▶ Slightly decrease the temperature of the device. [0.5°C (1°F)] Ex) 37.5°C → 37.0°C ▶ Initiate egg rotation test verifying if the egg rotation function is not OFF. ▶ Use the hatchery egg of healthy parent birds.
If the chick is born later than the estimated date	<ul style="list-style-type: none"> ▶ If the setup temperature is too low. 	<ul style="list-style-type: none"> ▶ Slightly increase the temperature of the device. [0.5°C (1°F)] Ex) 37.0°C → 37.5°C
If the hatching date of the eggs are too varied (when they're not hatched at the same time but differently during long term)	<ul style="list-style-type: none"> ▶ Difference of hatchery egg storage time. ▶ Occurred from the diversity of hatching temperature. 	<ul style="list-style-type: none"> ▶ When possible, minimize the egg storage period/time. ▶ Check the temperature difference within the device. (sunlight and temperature of hatching room, etc)
When desiring to hatch different types of eggs at the same time	<ul style="list-style-type: none"> ▶ The hatching rate is lowered as the days to hatch are different 	<ul style="list-style-type: none"> ▶ Mark the hatching date on the egg and move to other device (generator) according to the estimated hatching date. ▶ It is convenient if you have other additional devices which can be used as generator chamber when different eggs are placed together at the same time.

Troubleshooting and measures

Symptom	Estimated cause (possibility)	Solutions
If the power is not on	<ul style="list-style-type: none"> ▶ Verify if the power cord is correctly inserted. ▶ Verify if there is no power failure/blackout. ▶ Verify if the plug is faulty or not. ▶ Verify if the power cord and pump power cord locations are not switched. 	<ul style="list-style-type: none"> ▶ Insert correctly the power cord again. ▶ Verify other nearby electronic and electric devices. ▶ Verify and try other power socket. ▶ Insert after verifying the correct location.
If the temperature is too high / low	<ul style="list-style-type: none"> ▶ Verify the setup temperature. ▶ Verify if the air circulation FAN does not rotate. 	<ul style="list-style-type: none"> ▶ Adjust the temperature setup to desired temperature. ▶ Disconnect the power plug from the socket, separate the main body and brush or clean the air circulation FAN.
If the humidity is too high / low	<ul style="list-style-type: none"> ▶ Verify if there is enough water. ▶ Verify the setup humidity. <p><If it's too low></p> <ul style="list-style-type: none"> ▶ Verify if the water is insufficient or not. ▶ Verify if the view-window is correctly closed. <p><If it's too high></p> <ul style="list-style-type: none"> ▶ Verify the nearby environment. ▶ Verify if there is any water inside the tray or in the bottom body. 	<ul style="list-style-type: none"> ▶ Supply enough water. ▶ Adjust the desired humidity in setup. ▶ Try the factory initialization. <p><If it's too low></p> <ul style="list-style-type: none"> ▶ Supply water. ▶ Verify if there is any alien substance and close again. <p><If it's too high></p> <ul style="list-style-type: none"> ▶ Adjust the environment of the incubator. ▶ Eliminate the water inside the tray.
It produces noise. * There is certain level of noise due to the fan for air circulation within the device.	<ul style="list-style-type: none"> ▶ Verify if there is any object on the device. ▶ Verify if there is any vibration on the floor or the device was installed on a table. ▶ Verify if there is any alien substance around the FAN after the incubation. 	<ul style="list-style-type: none"> ▶ Remove all the objects from the top of the device. ▶ Install the device in other stable place. ▶ Disconnect the power plug from the socket, separate the main body and brush/clean the FAN for air circulation.
When dews are formed within the device * When maintained in high humidity there may be formed dews.	<ul style="list-style-type: none"> ▶ Verify if the surrounding temperature of the installed place is too low. 	<ul style="list-style-type: none"> ▶ Please install in a place within the conditions of an incubator.

⚠ Please verify if every function of the device is performed properly by operating sufficiently the device before locating the eggs. In case of incubation of costly eggs you might need check-up or adjustment of internal temperature to prevent failure of incubation. In the checkup or examination please use a high-reliability thermo-hygrometer. (Rcom Digilog3 model or higher)

Specification

PRO PLUS 10 / PRO 10

Rated voltage	DC 12[V] 3[A]
Power consumption	Max 36[W] Average 21[W]
Temperature adjustment scope	20 ~ 42 [°C] / 68 ~ 107.6 [°F]
Humidity adjustment scope	20 ~ 70 [%] (May vary according to surrounding environment)
Capacity	In case of egg 10[units], in case of quail egg 30[units]
Weight of product	N.W. 1.5[Kg], G.W 2.5[kg]
Size of product	(w)259 x (L)236.5 x (H) 172 [mm]

Extension of free service is not allowed for this product.
The warranty period is one year from the date of purchase.

※ How to register the product online:

1. Go to www.rcom.co.kr
2. Click on “English”
3. Sign up for membership first, then log in using those credentials
4. Click “register products”
5. Fill in all required fields and click “Save”
6. Product registration is now completed.

※ Details required to register for the guarantee:

1. The name of the product model
2. The product serial number
3. Your purchase date
4. The name of the store of purchase

※ COMPARATIVE

	Temperature adjustment function	Humidity adjustment function	Candling function	Egg rotation	APS (Auto Pumping System)
PRO PLUS 10	Automatic	Automatic	O	Automatic	O
PRO 10	Automatic	Manual	O	Automatic	X(Option)
ECO PLUS 10	Manual	Manual	X	Automatic	X(Option)

Guide on Customers' Damage Compensation

Types of damages of customers	Details on compensation	
	Within guarantee period	After expiring guarantee period
In case of naturally occurred failure in function or performance in normal condition of use.	Free repair	Paid repair
Failure in function or performance due to intention or error of the customer.	Paid repair	
<ul style="list-style-type: none"> ■ In case of failure due to natural disaster (fire, sea wind, gas, earthquake, storm and flood). ■ When replacing expendable part normally abraded during the use. ■ Breakdown due to abnormal power source or faulty connection device. ■ Breakdown due to repair or remodelling by person any other than the service engineer of headquarters or the service center. ■ External factors which are not defect of the product. ■ Breakdown due to use of different rating voltage. ■ Breakdown due to use of consumable, optional product not designated by the company. ■ Breakdown or loss due to drop during the transportation. ■ Breakdown for not cleaning the product / Breakdown due to use of other liquid than distilled or purified water / Breakdown due to use of the incubator as brooder device (developer) / Breakdown due to incorrect device control / Breakdown due to manner of use not mentioned in the instruction manual / If the customers' fault is clear. 		

⚠ The success of incubation may vary according to different factors. The manufacturer and distributor are not responsible for failure of incubation of costly eggs, loss of life, property damage due to negligence of user, remodeling, painting, modification of purpose of use or power failure. When incubating parrot or costly birds please verify the internal temperature (adjust) before use. Please read carefully the instruction manual before use to avoid failures.

Rcom is designed for user's easy and convenient use.
It can be changed without notice for improvement in performance, design,
treatment and software, etc.

Ver.3.0

www.Rcom.co.kr

SELLER

MANUFACTURER

AUTOELEX CO.,LTD.

- OFFICE : 218, Sangdong-ro, Gimhae-si,
Gyeongsangnam-do, 50805 Korea
- TEL : +82-55-337-2561
- E-MAIL : sales@autoexlex.com

Choose for the best design, highest quality, value and performance!