

MAX 20 DO

MAX 50 DO

User's Manual

DIGITAL BIRD INCUBATOR

Model : MX-20DO / MX-50DO

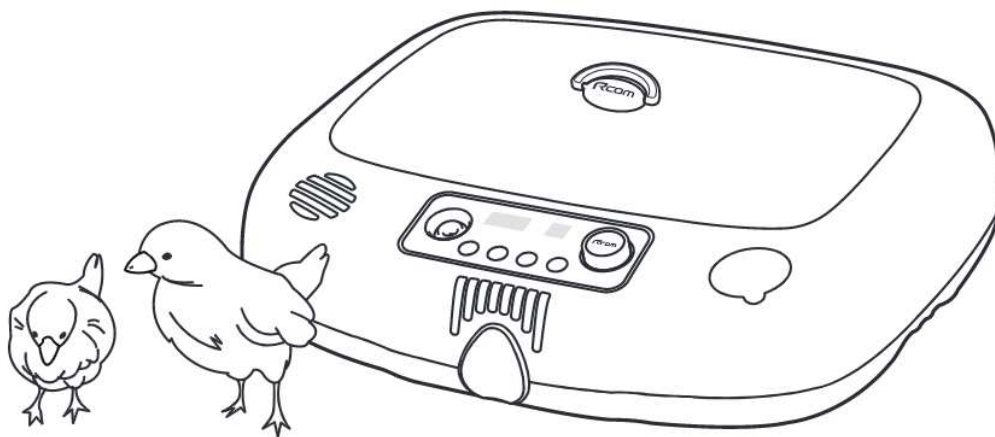

This manual is produced for common use and may contain images or contents different from the purchased product. In addition, to improve the performance of the product, specifications are subject to change without prior notice.

Rcom



MAX 20 DO
VIDEO MANUAL



MAX 50 DO
VIDEO MANUAL

Contents

How to use Rcom MAX 20 DO, MAX 50 DO

1. Introduction	
(1) Rcom MAX 20 DO, MAX 50 DO Introduction	3 ~ 9
(2) Safety precautions	
(3) Name of each part and basic components	
(4) Names and functions of operational parts	
2. Before use	
(1) How to Assemble the Incubator / Egg-turning plate	10 ~ 13
(2) What is Incubation room?	
(3) Preparation of incubation	
3. Function Settings	
(1) Start incubation	14 ~ 20
(2) How to easily set the early / end stages of incubation	
(3) Temperature setup	
(4) Humidity setup [+ How to stop humidification]	
(5) Egg-turning setup	
(6) Cooling control cycle setup	
(7) How to change Celsius/Fahrenheit	
(8) How to setup abnormal High/Low temperature alarm	
(9) How to ON/OFF sound	
(10) Candling	
(11) Return to factory settings	
(12) How to set the dry mode / How to terminate incubation	
4. Incubation	
(1) Humidity and ventilation control during incubation / Management after incubation / Dew condensation	21
5. How to separate and clean	
(1) How to separate and clean	22 ~ 23
6. Product Information	
(1) FAQ	24 ~ 27
(2) Troubleshooting and measures	
(3) Specification / Guide to Consumer Damage Compensation	

⚠ The success of incubation may vary according to different factors. The manufacturer and distributor are not responsible for failure of incubation of costly eggs, loss of life, property damage due to negligence of user, remodeling, painting, modification of purpose of use or power failure. When incubating parrot or costly birds please verify the internal temperature (adjust) before use. Please read carefully the instruction manual before use to avoid failures.

Mark explanation



CAUTION: caution mark for mistakes that can cause loss of animal life, property damage, or product breakdown or damage.



Prohibited



Do not disassemble



It is necessary to keep



Remove the power cord from the outlet.

Tip : References or useful suggestions in using Rcom product.

● Rcom MAX 20 DO, MAX 50 DO

We sincerely thank you for purchasing our Rcom incubator. Rcom incubator provides optimum incubation conditions based on the know-how and integrated technology of AUTOELEX by controlling the environment with AI. However, the user's incubation knowledge and proper operation are very important for the best hatching result. Users need to carefully observe and adjust all incubation conditions such as species of eggs, temperature and humidity for each incubation period, and the hatching room conditions. We sincerely suggest you carefully read the instructions before use to allow for the successful incubation and proper use of the device.

● Features of Rcom MAX 20 DO, MAX 50 DO

**Rcom MAX 20 DO: 20 eggs capacity for chicken egg size (52 quail egg size, 10 goose egg size)
Rcom MAX 50 DO: 48 eggs capacity for chicken egg size (116 quail egg size, 24 goose egg size)**

[Main Functions]

- * Jog dial for optimized user interface
- * Automatic temperature, humidity control and setting
- * Easy settings for early and end stage incubation
- * Automatic egg turning
- * FND display
- * Integrated candling function
- * Main body drying function
- * Anti-bacterial humidification unit
- * Double-glazed view window to minimize the influence of outside temperature
- * Optimal air circulation technology

[Easy Function]

- * LED ambient light changing its color by the device status
- * Water supplement alarm function
- * Universal tray for various size of eggs
- * Trays for small(quail eggs), standard(chicken eggs), and large(goose eggs) - sold separately
- * Alarm function for abnormal temperature (high and low temperature) for sudden external temperature change
- * One-touch body locking device
- * Detachable top and bottom for easy cleaning after hatching
- * Low-noise stepping egg turning motor
- * Easily replaceable built-in control box
- * A handy handle for easy opening and closing of the window

[Other Functions]

- * Retaining hatching data during power failure. Notification of power failure
- * Anti-skid egg-turning plate for preventing leg deformities in newborn birds
- * °C(Celsius) and °F(Fahrenheit) convertible

● Electrical hazards

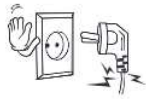

! Do not use a damaged power cord or loose outlet. Risk of electric shock or fire.



! Do not pull the cord when taking out the power cord, and keep wet hands away from connecting plug. Risk of electric shock or fire.



⊘ Never unplug when using the unit. Operation interruption may result in loss of life inside the unit.



! Do not twist or crush electric cord. Risk of electric shock or fire.



! Do not insert multiple connecting plugs in an outlet. Risk of fire or electrical overload.



! If the machine will be stored for a long time, please clean it before and after storage. Accumulated dust can pose a fire or shock risk.

● Installation, use related precautions



! Do not put a person in the product. He/she may be hurt or killed.



! Do not turn off the power while your pet is in the device. It may be hurt or killed.



! Do not install in dusty or dirty places. Dust or foreign matter may cause electric shock or fire.



! Do not install the product in direct sunlight. There is a possibility of discoloration of the case and rapid temperature rise may cause death of the animal.



! Do not install in wet or humid places. There is a risk of electric shock or fire if water gets inside.



! Avoid places that are too cold or hot and do not place fire or heat machines near the product. There is a risk of fire.



! Do not place the power cord near sources of heat. The coating on the cord may melt and cause fire or electric shock.



! Please install it firmly when installing on cabinet or shelf. Falling or a fall of the product may cause malfunction and serious injury.



! Do not place the product upside down. The product may be damaged.



! Do not allow children to climb on the product. A fall of the product may cause injury or death.



⊘ Never disassemble, repair or modify the product as you please. It may cause electric shock and fire. If you need repair, please contact a service center.



! Be careful not to let foreign substances into the external hole of the product. It may cause electric shock, fire, and physical injury.



! If any unusual sounds or smoke appear on the product, unplug it immediately and contact a service center. It may cause electric shock or fire.



! Do not cover the ventilating opening. Inner temperature can rise, interrupting incubation.



! If you drop it or the case is broken, disconnect the power plug and contact the service center. Using as it is may cause electric shock or fire.

● Cleaning related precautions



! Do not spray cleaning chemicals directly onto the interior or exterior of the product. Spraying directly may increase the possibility of discoloration, cracking, peeling of the printed surface.



! Clean the incubator by a soft cloth with a neutral detergent.



! Wipe the dust on the power plug's pins and contacts with a dry cloth. It may cause electric shock or fire.



! When cleaning, be sure to remove the power cord and clean it with a soft cloth. Do not use chemicals such as wax, benzene, alcohol, thinner or lubricant etc.



! After cleaning, wipe off the water and activate the dry function to remove the water completely from the incubator before storage.
[How to set the dry mode: see page 20]



! At least once a year, please contact our service center or customer service center to check the machine. Failure to clean dust inside the product for a long period of time may cause fire or malfunction.

1. Introduction

(3) Name of each part and basic components

● Rcom MAX 20 DO Name of each part

The serial number is on the back of the product. Product serial number (example: H20MX0000000000). If the serial number is damaged, customer service is not available for the product.

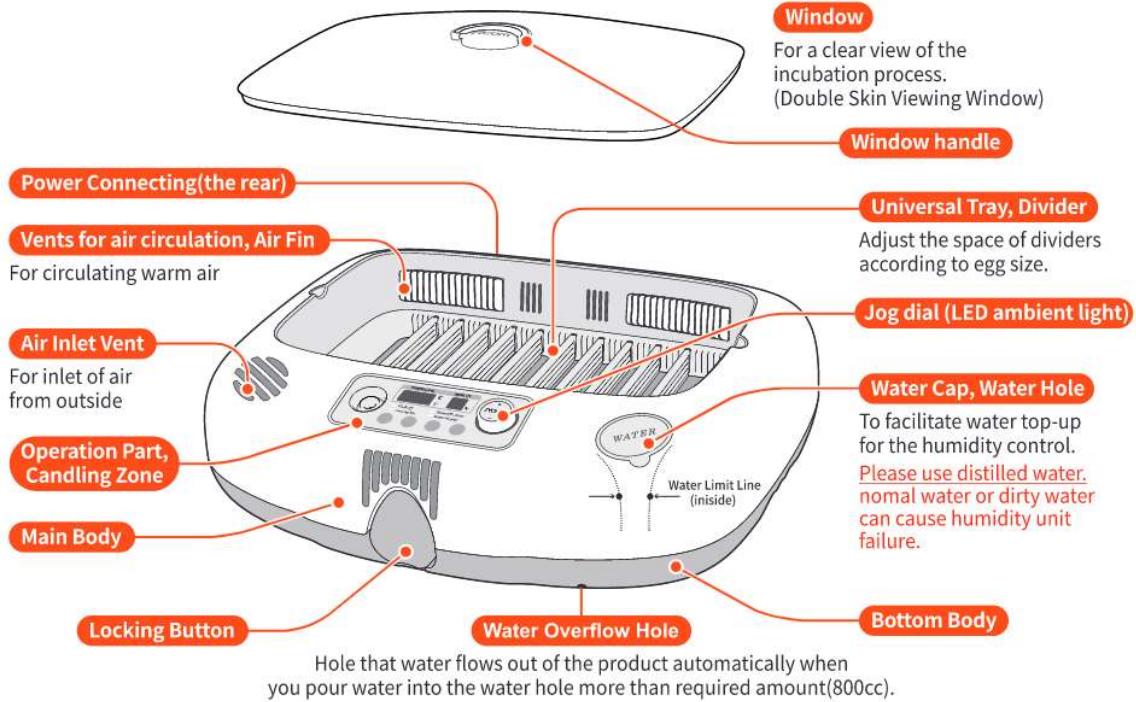

● Basic components

Main body	Bottom body	Window	Egg-turning plate	Universal tray SET
 * The Air Fin will be provided and attached to the main body(upper)				
20 Air fin(2EA)	Power cord	Manual	Brooding tray (Sold separately)	Rolling divider SET (Sold separately)
Small egg tray (Sold separately)	Standard egg tray (Sold separately)	Large egg tray (Sold separately)	Humidity Unit (Sold separately)	

1. Introduction

(3) Name of each part and basic components

● Rcom MAX 50 DO Name of each part

The serial number is on the back of the product. Product serial number (example: H50MX0000000000).
If the serial number is damaged, customer service is not available for the product.

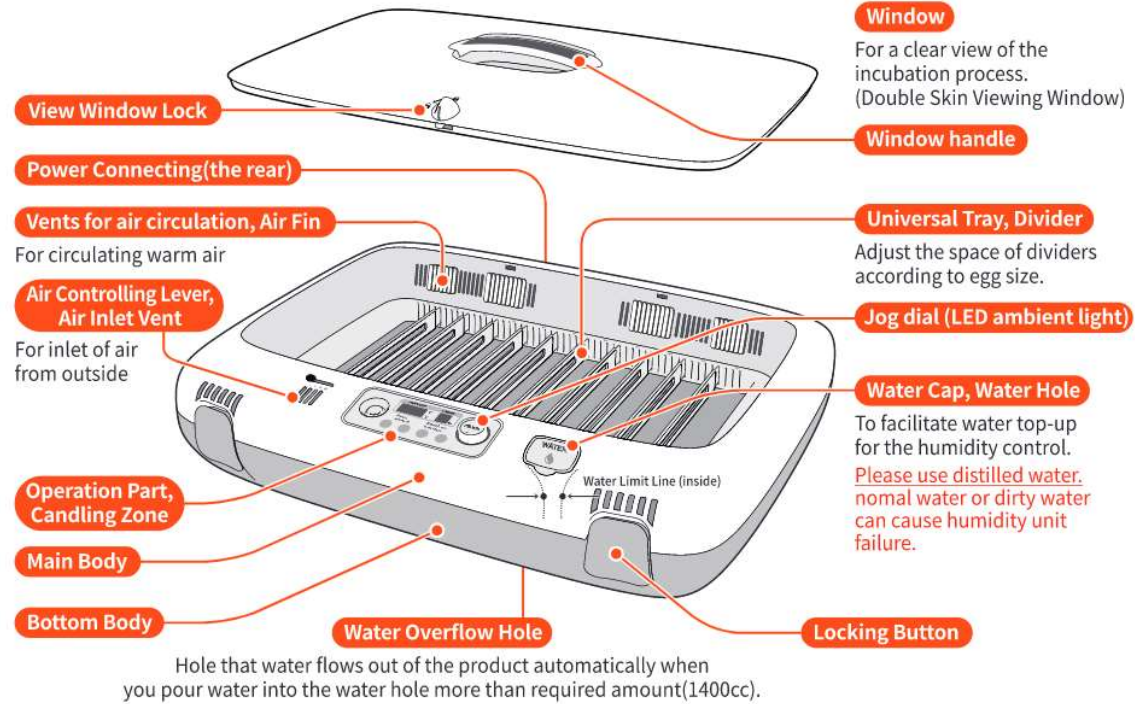

● Basic components

				 ※ Divider 10EA
Main body	Bottom body	Window	Egg-turning plate	Universal tray SET
 9 section x 2 pieces 7 section x 2 pieces (It will be provided in the assembled. Please do not change its position and direction.)				
50 Air fin(4EA)	Power cord	Manual	Small egg tray (Sold separately)	
Standard egg tray (Sold separately)	Large egg tray (Sold separately)	Humidity Unit (Sold separately)	How to replace it	

● Names and functions of operational parts

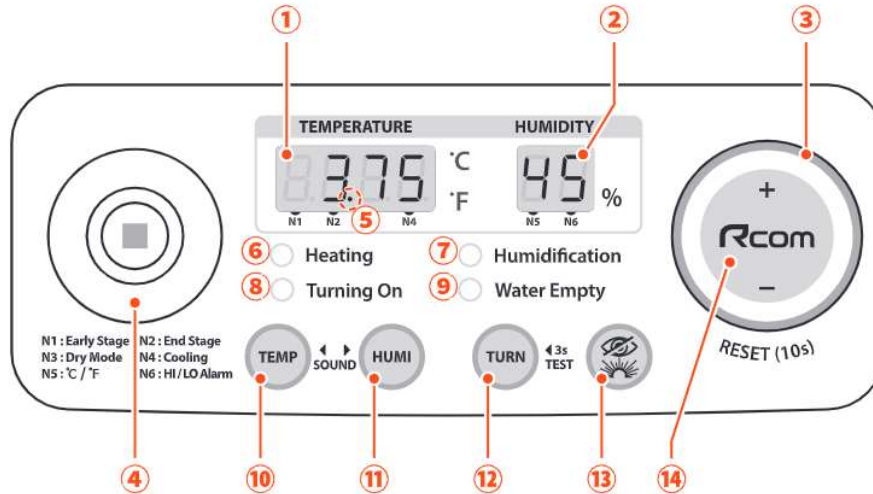













- ① **Temperature display** : Shows current temperature
- ② **Humidity display** : Shows current humidity
- ③ **LED ambient light** : Displays the machine status in color.
 - White : (Start, early and middle stages of hatching)
 - Yellow : (Final stage of hatching)
 - Green : (Other settings)
 - Blinking red : (Abnormal occurrence)
- ④ **Candling zone** : Press the Test button for 1 second to use it as an egg inspection machine.
- ⑤ **Power failure notification** : It blinks when power failure during incubation.
(To remove, press the Jog Dial once.)
- ⑥ **Heater lamp** : Lighting on when working
- ⑦ **Humidification lamp** : Lighting on when working
- ⑧ **Egg turning lamp** : Blinking when working
- ⑨ **Water empty lamp** : Blinking with water shortage
(The Water Empty alarm sounds every 10 seconds.)
- ⑩ **Temperature (TEMP) button** : When pressing the button, the temperature value flickers.
You can adjust and set the desired value with the Jog Dial.
- ⑪ **Humidity (HUMI) button** : When pressing the button, the humidity value flickers.
You can adjust and set the desired value with the Jog Dial.
- ⑫ **Egg-Turning (TURN) button** : When pressing the button, the egg turn angle blinks in the temperature display. You can adjust and set the desired value with the Jog Dial.
- ⑬ **Candling button** : Press and hold for 1 second to turn on the LED light in the candling zone.
- ⑭ **jog dial** : Entering the options menu (N1 to N6) – **Need to unlock first by pressing the jog dial.**
 - Press and hold for 1 second to check the set temperature and humidity.
 - Press and hold for 10 seconds for factory initialization.

1. Introduction

(4) Names and functions of operational parts

● Easy function operation

operation is available only when the lock is released by pressing the jog dial. (Unlocked sign – d.UnL)
 The jog dial is automatically locked after 10 seconds without jog dial input. (Locked sign – d.Loc)

<p>N1 How to easily create early stage *Temp. 37.5°C *humi. 45% *Egg turning ON(every hour) Egg turn operating time 11seconds *Cooling control cycle setup OFF</p>	 <p>Press after adjusting to N1</p>	<p>N2 How to easily create end stage *Temp. 37°C *Humi. 65% *Egg turning OFF *Cooling control cycle setup OFF</p>	 <p>Press after adjusting to N2</p>
<p>Temperature Settings</p>	 <p>Press after adjusting</p>	<p>Humidity Settings</p>	 <p>Press after adjusting</p>
<p>How to set egg turning cycle and operation time</p>	 <p>Press after adjusting</p>	<p>Egg turning test</p>	 <p>Press and hold for 3 seconds</p>
<p>N3 How to set to the dry mode * Run for 30 minutes.</p>	 <p>Press after adjusting to N3</p>	<p>N4 How to enter the cooling control cycle</p>	 <p>Press after adjusting to N4</p>
<p>N5 How to switch between Celsius and Fahrenheit</p>	 <p>Press after adjusting to N5</p>	<p>N6 How to enter Abnormal High and Low temperature alarm setting</p>	 <p>Press after adjusting to N6</p>
<p>How to set sound ON / OFF</p>	 <p>Press at the same time</p> <p>ON 5.00</p> <p>OFF 5.0FF</p> <p>Press after adjusting</p>		
<p>Humidifier Device OFF method</p>	 <p>Set the below 30%</p> <p>Press</p>		
<p>How to do factory reset</p>	 <p>Press and hold for 10 seconds</p>		

2. Before use

(1) How to Assemble the Incubator / Egg-turning plate

● Rcom MAX 20 DO

5 Window



4 Universal tray, Divider

* Can equip only one tray



3 Main body

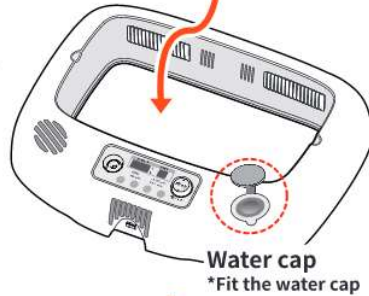

2 Egg-turning plate

*Attention of the direction

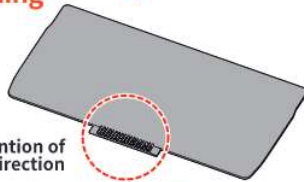

1 Bottom body

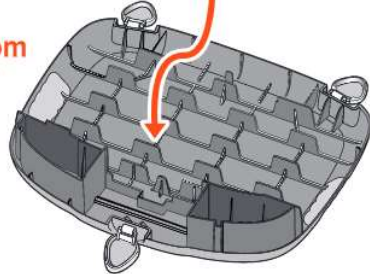

6

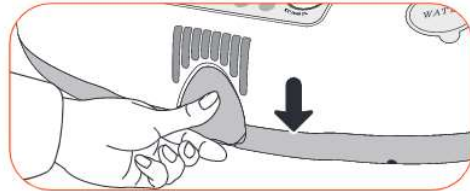

▶ Lock the three locking buttons at the front and rear of the incubator.

7

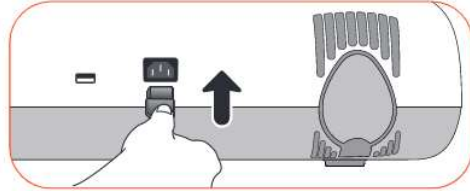

▶ Insert the power cord in the socket at the back of the main body.

⚠ Caution when assembling the air fin

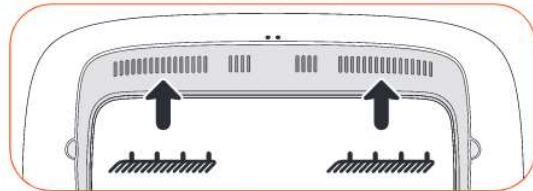

⚠ Two air fins are provided and attached to the main body(upper). You can use the incubator with the air fins attached. When the air fins are removed for cleanings, ensure that they are reattached in the same position and direction after cleaning. If the position and direction of the air fins are different, it may affect the resulting hatch rates, so please ensure this procedure is followed.

⚠ Caution when assembling the egg-turning plate

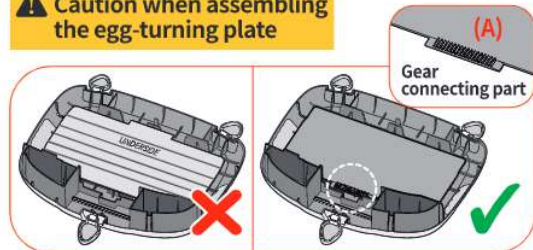

⚠ If the egg-turning plate is not assembled correctly, it may cause incubator failure. The gear connecting part(A) of egg-turning plate must be on the top side.

2. Before use

(1) How to Assemble the Incubator / Egg-turning plate

● Rcom MAX 50 DO

5 Window



4 Universal tray, Divider

* Can equip only one tray

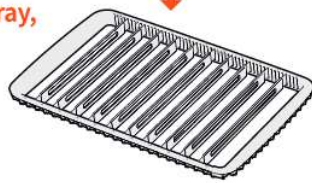

3 Main body

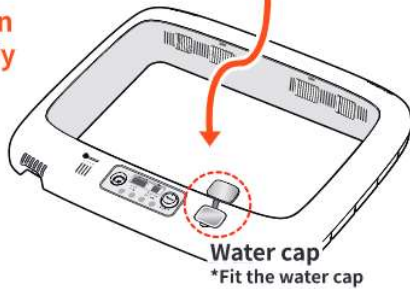

2 Egg-turning plate

*Attention of the direction

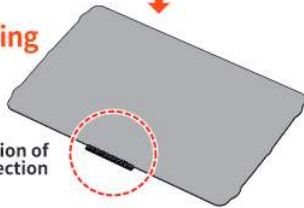

1 Bottom body

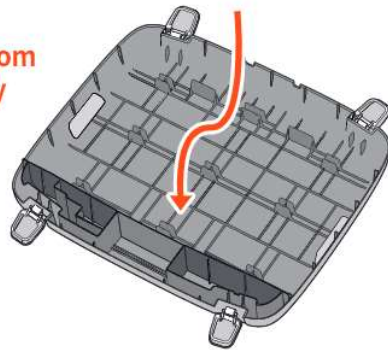

6 ▶ Lock the four locking buttons at the front and rear of the incubator.

7 ▶ Insert the power cord in the socket at the back of the main body.

⚠ Caution when assembling the window

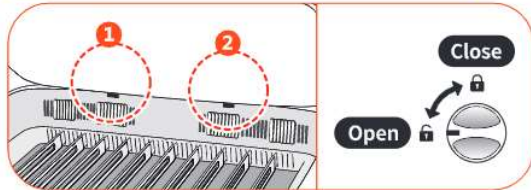

⚠ Please align the two lugs on the back side of the view window to the body (top) as shown in the picture. It is not assembled in the reverse order. Please don't lift the product with the handle of the view window in the locked status.

⚠ Caution when assembling the air fin

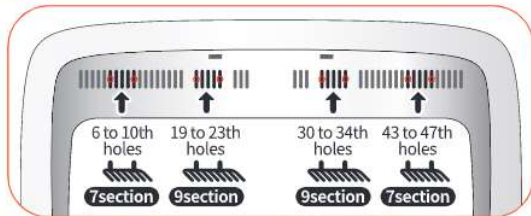

⚠ Four air fins are provided and attached to the main body(upper). You can use the incubator with the air fins attached. When the air fins are removed for cleanings, ensure that they are reattached in the same position and direction after cleaning. If the position and direction of the air fins are different, it may affect the resulting hatch rates, so please ensure this procedure is followed.

⚠ Caution when assembling the egg-turning plate

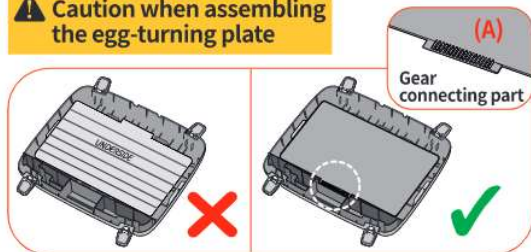

⚠ If the egg-turning plate is not assembled correctly, it may cause incubator failure. The gear connecting part(A) of egg-turning plate must be on the top side.

2. Before use

(2) What is incubation room?
(3) Preparation of incubation

● What is incubation room?

The Incubation room is a confined space for setting and operating an incubator efficiently. An Incubation Room environment has a considerable effect on hatch rate. Controlling the incubator environment is recommended; there should be little noise or vibration and constant temperature ranging upwards from 22~25°C(71.6~77°F) with small variation in temperature. For optimum performance, pay attention that your incubator isn't exposed to temperature drops compared with daytime. Do not expose the incubators to sunlight during daytime and also ensure that incubator is not placed near drafts or wind from air conditioning units.

● Preparation of incubation

- ▶ When power is connected, the current temperature and humidity are showed in the FND display.

Tip : It may smell a little in first operation however this is normal.

- ▶ Open the water cap and fill the hole with the distilled water, and refill water after about 5 minutes again up to the limit line on its inside mark.

Water quantity for Rcom MAX 20 DO: 800cc

Water quantity for Rcom MAX 50 DO: 1300-1400cc

Pouring more water than needed will result in an overflow through the water drainage hole below the main body (bottom).

⚠ If you use Mineral water or Tap water for humidification, the humidity unit can be broken easily because of water scales. We strongly recommend you to use only "DISTILLED WATER" for your machine, and Autoalex Co.,Ltd & our distributors do not indemnify for warranty service not only if you have any problem with using mineral water, regular water, tap water and the like but also if you had improper management or handling for your machine. In this case, Autoalex Co.,Ltd. & our distributors will charge for your after service.

⚠ Please note that shaking the incubator body after filling water will cause it to spill out and cause breakdown.

Tip : During incubation period, check the level of water once every 3 days and replenish it with distilled water. (After replenishing distilled water, check again after 5minutes and refill again)

⚠ When using the incubator without humidifying water or at a low humidity under RH 30%, you must stop the humidification function. If you keep the humidity unit on without enough water, the unit will be damaged or its life will be shortened. When the humidification function is stopped, the Humidification lamp and Water Empty alarms will be off.
[How to turn off the humidification function: see page 15]

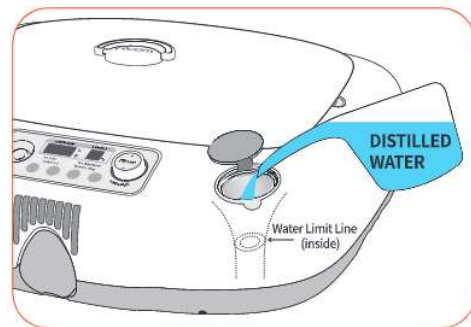
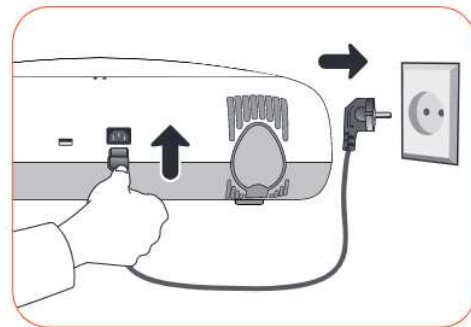

2. Before use

(3) Preparation of incubation

- ▶ Place the eggs in the universal tray while adjusting the divider spacing according to the size of the eggs. The eggs to incubate must be fertilized eggs.

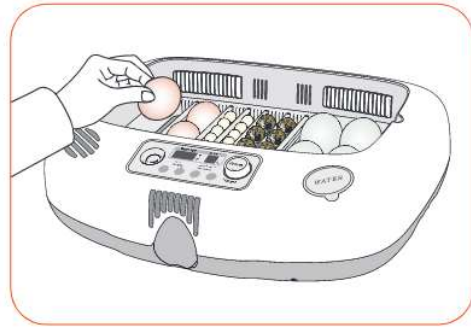

- ⚠ When using the universal tray, there must be some gaps (approximately 2 mm) between the ABS divider and the egg for easy egg turning.

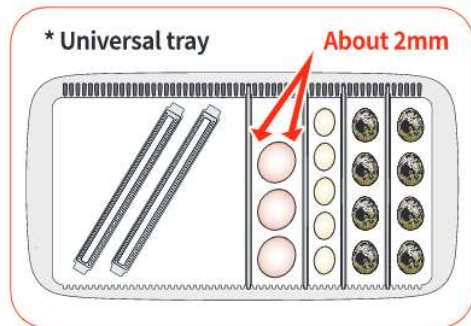

- Optional: Rolling dividers (1 set of 10ea.)
* Accessories for Rcom MAX 20 DO
Fit rubber rings around the roller dividers and place the eggs on them keeping the proper spacing to prevent the eggs from rolling off.

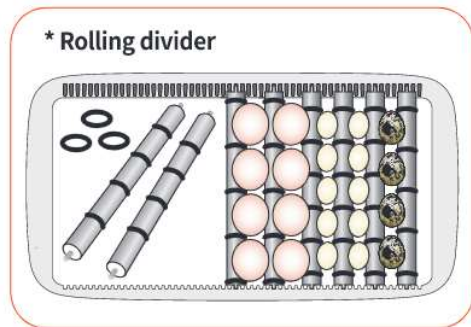

- ▶ Close the view window.

- ⚠ Be careful to close the view window completely. If not, the temperature and humidity will fail to go up.

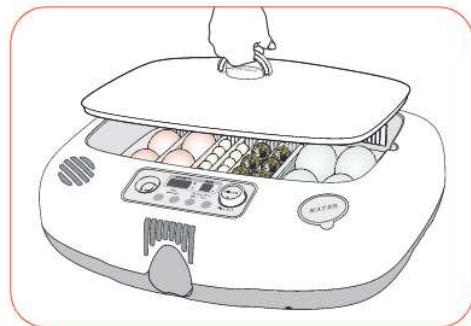
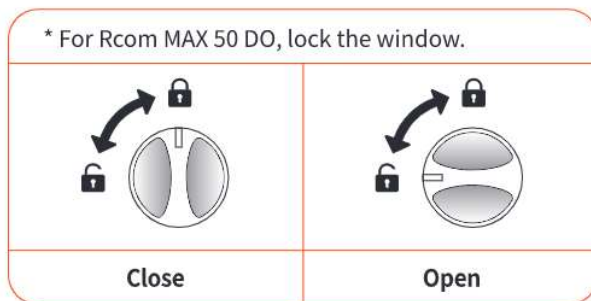

- ⚠ Make sure to operate the machine sufficiently to check that all functions are working properly before putting in eggs and starting hatching.

3. Function settings

(1) Start incubation
(2) How to easily set the early / end stages of incubation

● Start incubation

- ▶ When the power cord is connected, the ambient LED on the control panel is displayed in white (early and mid-incubation stages) and incubation starts with the default temperature and humidity. It takes up to 1 hour to reach the set value.

[Default setting : Temperature 37.5°C (99.5°F), Humidity RH 45%]

- ▶ Make sure to turn on the egg-turning before starting incubation, and turn it off 3 days before hatching. At this time, it is recommended to increase the humidity to 60 ~ 70%.
[See below for a simple setup for the final stage of hatching [N2]]

Tip : There can be some smell the first time you use the incubator, that is normal.

Tip : Power failure notification

When firstly input power, or power failure during incubation, the second dot (".") of the Temperature display will blink and alarm. Press the jog dial to release the alarm.

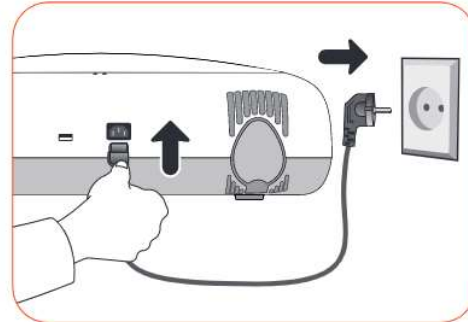

● How to easily set the early [N1] / end stages [N2] of incubation

- ▶ With an easy setting, you can automatically set the egg-turning cycle and humidity in the early, middle and final stages of the incubation period.

[Easy settings for initial and middle stages] - N1

- ▶ Turn the jog dial to select N1 and press it to automatically set the early stage value, and then the ambient LED will be displayed in white.

[Temperature 37.5°C / Humidity RH 45% / Turning ON (Every hour), Egg-turn operating time 11seconds / Cooling control cycle setup OFF]

Initial and middle stages [N1] :

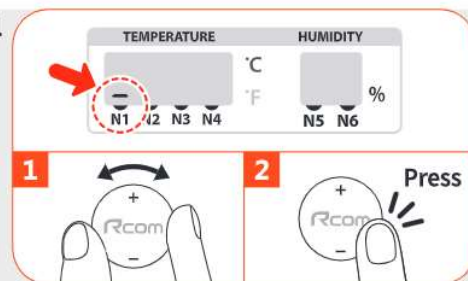

[Easy setting for an end stage] - N2

- ▶ Turn the jog dial to select N2 and press it to automatically set the final stage value, and then the ambient LED will be displayed in yellow.

[Temperature 37°C / Humidity RH 65% / Turning OFF / Cooling control cycle setup OFF]

End stage [N2] :

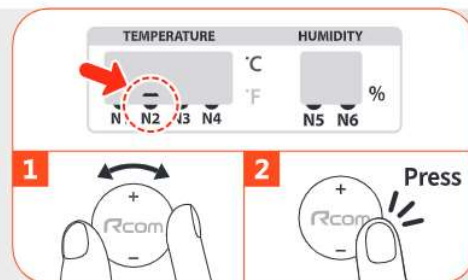

- ▶ Temperature and N2 will be alternately shown on the temperature display regularly.

Tip : The hatching environment can be different for each bird, so if you want to enter different values, set the temperature and humidity, respectively.

Tip : If you made the wrong selection, press any button except the jog dial to return to the previous state.

3. Function settings

(3) Temperature setup
(4) Humidity setup

● Temperature setup

- ▶ When pressing the TEMP button briefly, “tEP (temperature)” is displayed in the temperature display and the set value blinks.
- ▶ When blinking the setting value, the temperature increases or decreases by 0.1°C by turning the jog dial.
[Default : 37.5°C (99.5°F)]
[Setting range : 20 to 42°C (68 to 107.6°F)]
- ▶ After changing it to the desired value, press the jog dial once to save the changed setting.

Tip : If you made the wrong selection, press any button except the jog dial to return to the previous state.

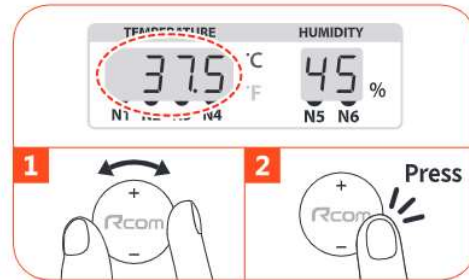
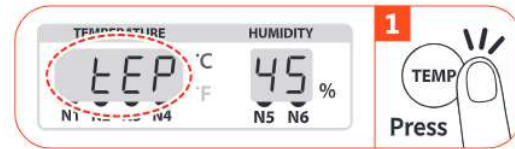

● Humidity setup [+ How to stop humidification]

- ▶ When pressing the HUMI button briefly, “rH (humidity)” is displayed in the humidity display and the set value blinks.
- ▶ When blinking the setting value, the humidity increases or decreases by 1% by turning the jog dial.
[Default : RH 45%]
[Setting range : RH 30 ~ 70%]
- ▶ When the set value blinks, turn the jog dial to the left and set to less than 30%. The humidification function stops and Ⓐ appears on the FND display.

Stop humidification :
(set to less than 30%)

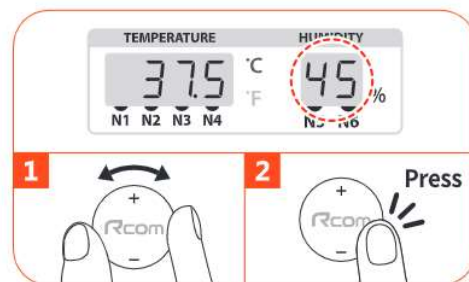

- ▶ After changing it to the desired value, press the jog dial once to save the changed setting.

Tip : If you made the wrong selection, press any button except the jog dial to return to the previous state.

● Egg-turning setup

▶ When the Turning On lamp is on, the egg turning function is on. At this time, it operates in a set cycle.

▶ When pressing the TURN button briefly, “turn” (egg turning) is displayed in the temperature display and the set value blinks.

▶ If you turn the jog dial while the set value is blinking, “OFF → 1Hr → 2Hr → 3Hr” will appear in this order.

[Default : 1Hr - Egg-turning once, every hour]
[Setting range : OFF / It can be set to 1 to 3 hours by 1 hour]

▶ After changing it to a desired value, press the jog dial once to save the changed set value and move to the step of setting the “An.g” (egg turning cycle).

▶ While setting the egg turning cycle, “SEC” (seconds) appears in the temperature display and the set value blinks in the humidity display.

▶ If you turn the jog dial while the set value is blinking, numbers “1 to 25” are displayed in order.

[Default : SEC 11 - 11 seconds]
[Setting range : 1 ~ 25 seconds by 1 second]

▶ After changing it to the desired value, press the jog dial once to save the changed setting.

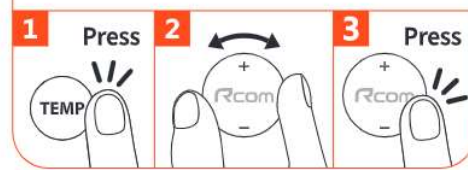
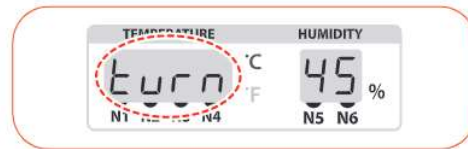

Tip : If you made the wrong selection, press any button except the jog dial to return to the previous state.

⚠ The Turning function must be turned off 3 days before hatching. **(If you select the easy setting in the final stage of hatching [N2], the egg turning function is automatically stopped.)**

▶ Egg turning test : If you press the TURN button for 3 seconds, egg turning test will be effected once.

⚠ It is recommended to use a brooder when chicks are about to hatch. Chicks may get hurt or die when they get caught in a machine. At this time, be sure to turn off the egg turning function. [Recommended product: Rcom Hatcher & Brooder - Rcom KINGSURO Brooder]

3. Function settings

(6) Cooling control cycle setup
(7) How to change Celsius/Fahrenheit

● Cooling control cycle setup [N4]

Tip : What is COOL(cooling control) Function?

It is a function which stops heating during the setup time(Max : 6hrs) among the 24 hours of a day. The periodic cooling is helpful for successful hatching but you might need preliminary knowledge to perform the cooling control process. Care should be used to that incorrect input may cause hatching failure.

▶ After releasing lock by pressing the jog dial, turn the jog dial to select N4 and press it will show "N4" (cooling control cycle) in the temperature display and the set value blinks.

▶ If you turn the jog dial while the set value is blinking, the set value increases or decreases by 1 hour.

[Default : OFF]

[Setting range : OFF ~ 6 hours by 1 hour]

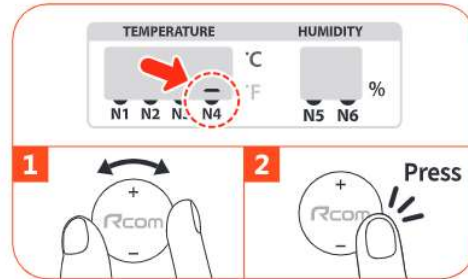

▶ After changing it to the desired value, press the jog dial once to save the changed setting.

▶ Temperature and N4 will be alternately shown on the temperature display regularly.

Tip : If you made the wrong selection, press any button except the jog dial to return to the previous state.

● How to change Celsius/Fahrenheit [N5]

▶ After releasing lock by pressing the jog dial, turn the jog dial to select N5 and press it will show "C.F" (Celsius/Fahrenheit) in the temperature display, and the LED of °C blinks.

▶ When you turn the jog dial, the LED blinks to display "°C" and "°F" alternately.

[Default : °C]

Tip : °C = 5/9 (°F - 32)

▶ After changing it to the desired value, press the jog dial once to save the changed setting.

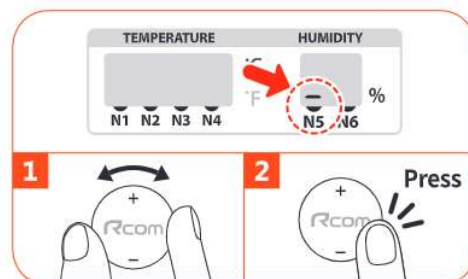

Tip : If you made the wrong selection, press any button except the jog dial to return to the previous state.

3. Function settings

(8) How to setup abnormal High/Low temperature alarm

Tip : What are Abnormal High/Low Temperature Alarm function?

It is an alarm function that notifies the users that the device's interior temperature is abnormally high or low. When the ambient temperature in the incubation room is higher or lower than the set temperature, the difference between the current temperature and the set point of "HI (high temperature)" or "LO (low temperature)" appear in the temperature display (e.g. 3 degrees, -4 degrees) while the alarm sounds. After that, even if the temperature returns to normal, the indicator flashes until it is released by pressing the jog dial. If the abnormal high and low temperature values are set to a other value than the default value [2°C] or [-3°C] "N6" will be displayed on the temperature display for every 8 seconds.

● How to setup abnormal High temperature alarm

EX:  ※ It shows that the set temperature is 3°C (3°F) higher than the actual temperature of the machine.

- ▶ After releasing lock by pressing the jog dial, turn the jog dial to select N6 and press it will show "HI" (abnormal high temperature alarm) in the temperature display and the set value blinks.
- ▶ When turning the jog dial while the set value is blinking, the set value increases or decreases in steps of 1°C.
[Default : 2°C (2°F)]
[Setting range : 0.0 ~ 5.0°C (0.0 ~ 5.0°F)]
- ▶ After changing to the desired value, press the jog dial once to save the changed setting value and move to the next step, "LO" (abnormal low temperature alarm).

Tip : If you made the wrong selection, press any button except the jog dial to return to the previous state.

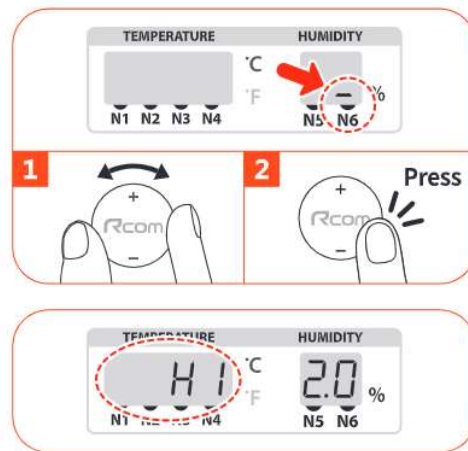

● How to setup abnormal Low temperature alarm

EX:  ※ It shows that the set temperature is 4°C (4°F) lower than the actual temperature of the machine.

- ▶ If you press the jog dial once more in the abnormal high temperature alarm setting step, "LO" (abnormal low temperature alarm) setting value will blink.
- ▶ When turning the jog dial while the set value is blinking, the set value increases or decreases in steps of 1°C.
[Default : -3°C (-3°F)]
[Setting range : 0.0 ~ -5.0°C (0.0 ~ -5.0°F)]
- ▶ After changing it to the desired value, press the jog dial once to save the changed setting.

Tip : If you made the wrong selection, press any button except the jog dial to return to the previous state.

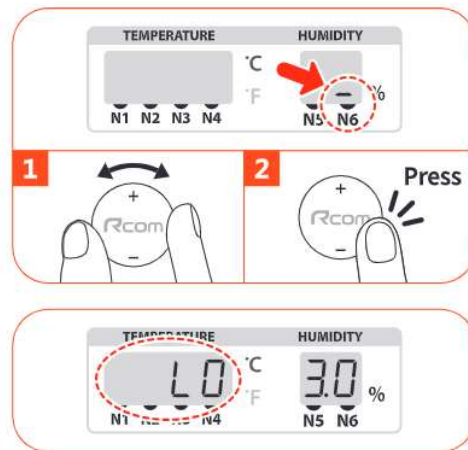

3. Function settings

● How to ON/OFF sound

- ▶ By pressing the TEMP and HUMI buttons at the same time, "S.on" will be shown in the temperature display.
- ▶ Turn the jog dial to turn the sound ON/OFF.
[Default : ON]
[S.on : Sound on / S.oFF : Sound off]
- ▶ After changing it to the desired value, press the jog dial once to save the changed setting.

Tip : If you made the wrong selection, press any button except the jog dial to return to the previous state.

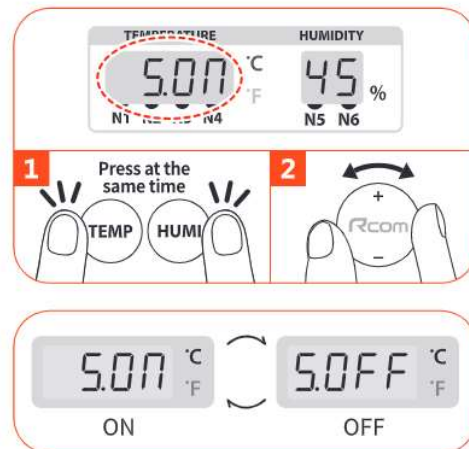

● Candling

Tip : Candling allows observation of the fertilized, unfertilized, suspended hatching or development of embryo. If there is any minute fissure on the egg after introducing to the incubator, the germs penetrate into it therefore the decomposition starts. It is therefore advisable to discard non fertile or contaminated eggs. It is also recommended to perform candling in the dark for improved visibility.

! Do not directly look into the LED light except in case of candling.

- ▶ The environment for candling must be dark for easier candling.
- ▶ Place the wide, round part of the egg onto the candling zone of the control panel, press the candling button to observe the inside of the egg (embryo or blood vessel). For safety, it lights up 1 seconds after the button is pressed.

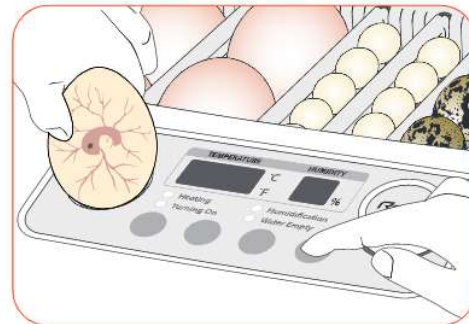
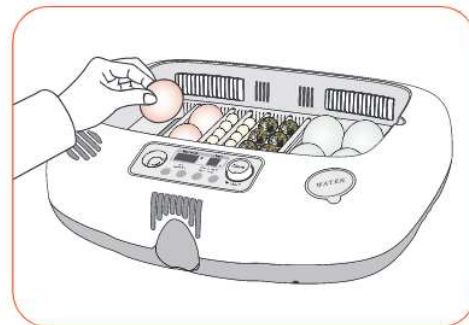

! Candling can be verified with the naked eye from 5 to 7 days after starting incubation. If blood vessels or embryos are not observed, the egg may be unfertilized egg therefore remove it from the incubator. If the egg shell is thick or dark, the inside may not be visible. White eggs as duck eggs are easier to observe.

! During candling, the ambient room temperature is lower than the inside of the incubator. Therefore, candling should be done in a warm room and finished within 10 minutes. Please pay special attention not to apply any impact on the eggs. Eggs may die due to stress caused by severe shaking or turning. Too frequent candling may cause failure to hatch.

! If the egg breaks in the candling zone, the liquid will flow inside and cause a breakdown. Care must be taken when examining eggs.

3. Function settings

(11) Return to factory settings
(12) How to set the dry mode / How to terminate incubation

● Return to factory settings

Tip : Used to initialize equipment to a setting when it was first released from the factory in case where the input value is changed due to mal-operation of equipment.

- ▶ When pressing the jog dial for 10 seconds, "rSt" appears on the display and the incubator is returning to the factory default setting. (Change to default settings)



● How to set the dry mode[N3] / How to terminate incubation

⚠ ALWAYS OPERATE [DRY MODE] BEFORE STORAGE after the hatching has been completed. Otherwise, it may cause malfunction on electronic device and sensor unit due to moisture remaining inside. Only after cleaning inside of the machine, empty the humidification water, and start [How to clean : see page 22~23].

- ▶ After releasing lock by pressing the jog dial, turn the dial to select N3 and press it to turn the drying mode on/off. [on : drying mode on / off : drying mode off]

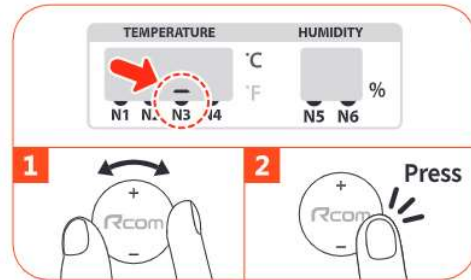

- ▶ When on is selected, "N3"(dry) will be shown on the temperature display and the drying mode is activated for 30 minutes.

If you want to stop during the drying mode is running, press the jog dial for 3 seconds or select N3 from the options and select off to stop.

- ▶ Temperature and N3 will be alternately shown on the temperature display regularly.
- ▶ The power cord should be unplugged to turn off the incubator. (The incubator has no separate power switch.)

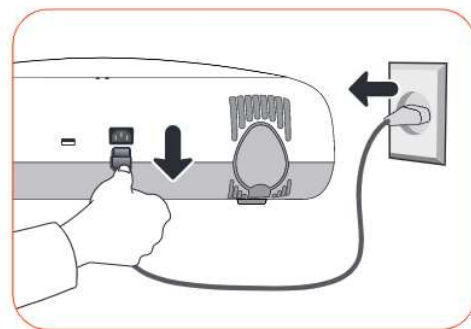

4. Incubation

(1) Humidity and ventilation control during incubation /
Management after incubation / Dew condensation

● Humidity and ventilation control during incubation

- ▶ When hatching, inside humidity of the incubator should be relatively high to prevent the thin membrane from drying out or hardening before hatching.
- ▶ When hatching, it's recommended not to open the lid often. This is because if you open the lid often humidity will be rapidly decreased and it will take a long time to regain the proper humidity.

! Incubator internal temperature is 37°C (99.5°F) or more, and hatching room temperature is below 28°C, in that case, 70% humidity is may not be able. The difference of ±5% humidity value may occur from the humidity sensors difference, and there are no problems at hatching.

- ▶ It's very important to maintain humidity higher 1~3 days before hatching than the early and middle incubation periods. Humidity requirements during incubation are 45~55% for waterfowl, 40~45% for poultry and 35~45% for parrot, in general. One day before hatching, all kinds of birds need about 60~65% humidity and sometimes need higher than that. However, in areas of high ambient humidity, lower levels of humidity may be needed during incubation. The humidity is automatically set at 65% when selecting the end stage incubation setting [N2].



● Management after incubation

- ▶ It is necessary to use a brooder for baby chicks because they are too weak to survive cool temperatures. It is also recommended to use a separate hatcher where possible, as this prevents feathers and dirt contaminating your incubator. If your incubator fails because of dirt and contamination then it will not be covered by the free warranty.

Tip : Hatcher : The machine for egg-hatching. Operate it 1~3 days before egg-hatching. (Rcom MARU H&B)
Brooder : The machine makes baby chickens or birds warm up against cold or cool environment. You can set up proper temperature and humidity. (Rcom Kingsuro brooder / Rcom MARU H&B / Rcom Bird brooder)

- ▶ As there is some difference in chick feed for each kind of bird, so it's desirable to obtain useful information about the chicks before hatching.

! Be sure to use a three-wavelength 20W bulb. If you use a bulb over 20W, temperature goes up, possibly killing the chick or causing a fire. If there is too much water and a chick would fall into water, its feathers get wet and it can be died of loss of body heat. Here, dry feathers with a hairdryer, etc.
Be sure to use a three-wavelength 20W bulb :
In case breeding room size 370(mm) x 270(mm) x 130(mm)

● Dew condensation

- ▶ This is a naturally occurring phenomenon when there is a significant difference in temperature between inside and outside of the incubator during incubation period. If this occurs, water may form in the inside bottom of the main body of the incubator (bottom part).

5. How to clean

(1) How to separate and clean

● How to separate and clean

⚠ Before start cleaning, make sure that all hatching, un-hatched eggs and pieces of shell inside are removed.

⚠ If the incubator goes through incubations several times, feather, dust, shell, etc. accumulate inside the main body, which may cause a breakdown. ALWAYS BE SURE CLEAN THE INCUBATOR BEFORE STORAGE.

▶ During humidification, a lot of alien matter sticks to the humidification heating part ① but this may not cause of failure. However, if you continue incubating and hatching without cleaning the scale, the humidification heater performance may deteriorated, ALWAYS BE SURE TO CLEAN THE INCUBATOR AFTER FINISH HATCHING. To reduce foreign substance, distilled water is recommended for humidification.

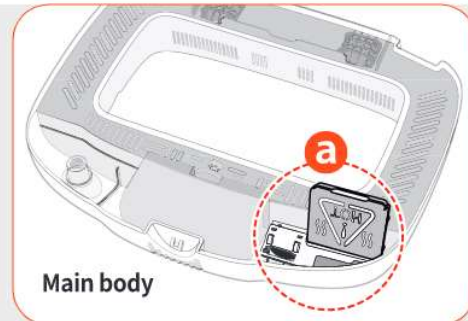

▶ Disconnect the power cord from the connection jack and also take out the plug from the power outlet.

⚠ Be sure to disconnect the machine's power cord from the power outlet.

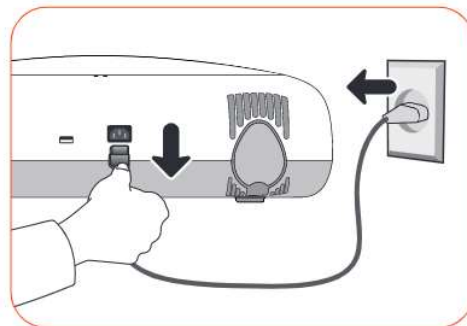

▶ Unlock and remove the locking buttons on the front and back of the incubator.

Rcom MAX 20 DO : 3
Rcom MAX 50 DO : 4

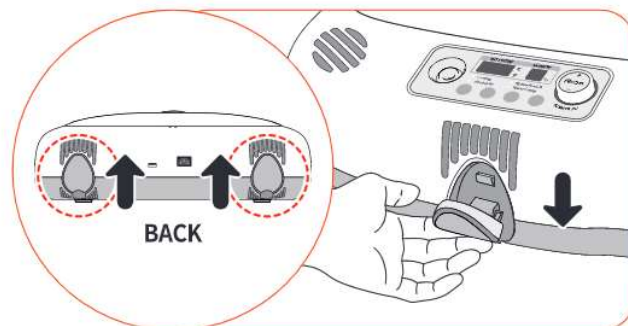

▶ After washing the tray, egg-turning plate, and body (bottom) thoroughly with water, dry them for a day in a well-ventilated place to completely remove the remaining moisture.

⚠ Please don't remove the black silicon cap on the back side of the body(bottom)

⚠ When cleaning the product, do not use organic solvents such as benzene, thinner, etc. It may cause deformation or discoloration.



5. How to clean

(1) How to separate and clean

- ▶ Remove scale with a toothbrush or a soft scrubber of the humidification unit on the main body(upper).

⚠ Beware of humidification heater part may be hot. WE RECOMMEND TO START CLEANING AFTER A WHILE WHEN THE HEATHER PART BECAME COOL DOWN ENOUGH.

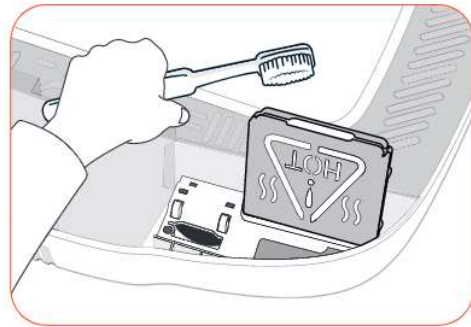

- ▶ Use a vacuum cleaner to remove the dust and thoroughly shake out the minute dust with a fine brush.

⚠ In case the incubator clean status is poor, it may cause fan noisy or stopping.

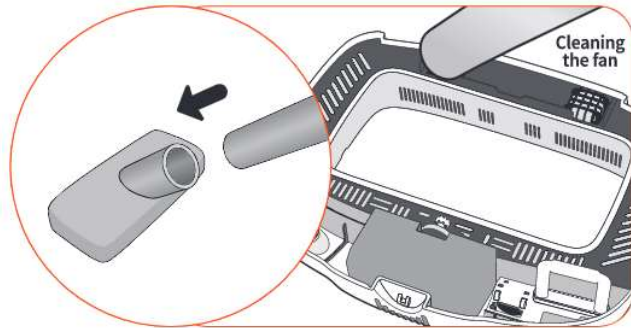

- ▶ After cleaning, reassemble in the reverse order of disassembly.

- ▶ Wipe the outside of the body with a damp cloth to clean it, and dry it in a cool, well-ventilated place before storage.
[How to assemble: refer to pages 10-11]

Tip : ALWAYS OPERATE [DRY MODE] BEFORE STORAGE after the hatching has been completed. Otherwise, it may cause malfunction on electronic device and sensor unit due to moisture remaining inside.
[How to operate Dry Mode : refer to page 20]

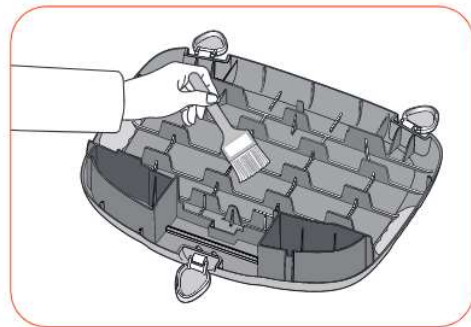

⚠ Caution when assembling the air fin

⚠ Four air fins are provided and attached to the main body(upper). You can use the incubator with the air fins attached. When the air fins are removed for cleanings, ensure that they are reattached in the same position and direction after cleaning. If the position and direction of the air fins are different, it may affect the resulting hatch rates, so please ensure this procedure is followed.

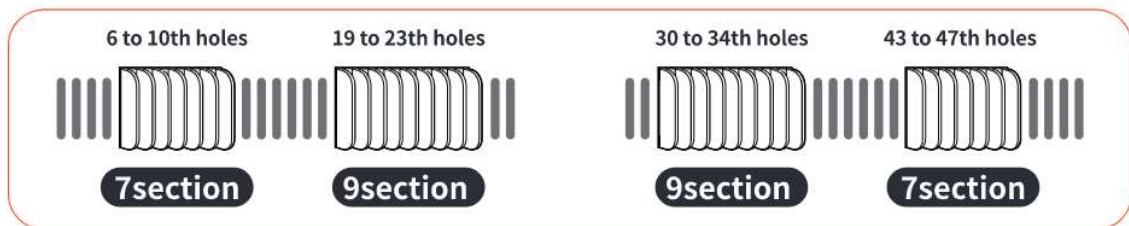

● FAQ

The Rcom products are manufactured under strict quality management with precise equipments, but there may be some defects in the product during the distribution. If there is any problem please contact to the Service center or Distributor of Rcom. We will do our best to resolve the problem as soon as possible. The product is designed in module methods which is easily replaceable by any qualified person.

* E-mail reception : sales@autoelex.com

Symptom	Estimated cause (possibility)	Solutions
If the average hatching rate is low	<ul style="list-style-type: none"> ▶ If the egg is unfertilized ▶ Germ infection ▶ Incorrect incubation setup ▶ Health condition of the mother bird ▶ Improper egg turning 	<ul style="list-style-type: none"> ▶ Candle the egg to verify if it's alive ▶ Sterilize the device ▶ Check all the setup process of the device Especially on the temperature ▶ Care the mother bird's health ▶ Verify if the egg turning is normally performed
If the chick is born earlier than the estimated date or when is malformed	<ul style="list-style-type: none"> ▶ If the setup temperature is too high ▶ If the egg turning is not performed 	<ul style="list-style-type: none"> ▶ Slightly decrease the temperature of the device [0.5°C (1°F)] Ex) 37.5°C → 37.0°C ▶ Initiate egg rotation test verifying if the egg turning function is not OFF
If the chick is born later than the estimated date	<ul style="list-style-type: none"> ▶ If the setup temperature is too low 	<ul style="list-style-type: none"> ▶ Slightly increase the temperature of the device [0.5°C (1°F)] Ex) 37.0°C → 37.5°C
If the hatching date of the eggs are too varied (when they're not hatched at the same time but differently during long term)	<ul style="list-style-type: none"> ▶ Difference of hatchery egg storage time ▶ Occurred from the diversity of hatching temperature 	<ul style="list-style-type: none"> ▶ When possible, minimize the egg storage period/time ▶ Check the temperature difference within the device (sunlight and temperature of hatching room, etc)
When desiring to hatch different types of eggs at the same time	<ul style="list-style-type: none"> ▶ The hatching rate is lowered as the days to hatch are different ▶ Eggs which didn't hatch can be contaminated by chicks hatched first 	<ul style="list-style-type: none"> ▶ Mark the hatching date on the egg and move to other device (generator) according to the estimated hatching date ▶ It is convenient if you have other additional devices which can be used as generator chamber when different eggs are placed together at the same time

 Please verify if every function of the device is performed properly by operating sufficiently the device before locating the eggs. In case of incubation of costly eggs you might need check-up or adjustment of internal temperature to prevent failure of incubation. In the checkup or examination please use a high-reliability thermo-hygrometer. (Rcom Digilog3 model or higher)

● Troubleshooting and measures For more detailed self-diagnosis, see Rcom homepage "SELF DIAGNOSIS" category.

Symptom	Estimated cause (possibility)	Solutions
If the power is not on	<ul style="list-style-type: none"> ▶ Verify if the power cord is correctly inserted ▶ Verify if there is no power failure/blackout ▶ Verify if the plug is faulty or not 	<ul style="list-style-type: none"> ▶ Insert correctly the power cord again ▶ Verify other nearby electronic and electric devices ▶ Verify and try other power socket

6. Product information

(2) Troubleshooting and measures

<p>Temperature will not go high enough</p>	<ul style="list-style-type: none"> ▶ Check your setting temperature ▶ Check the air circulation fan is working ▶ Return incubator to factory setting [Refer to page 20] ▶ Verify if there is any water in the bottom 	<ul style="list-style-type: none"> ▶ Set the temperature as required ▶ Take the power plug out of the outlet, and disassemble the main body for cleaning around the air circulation fan with brush ▶ Eliminate the water inside the bottom
<p>Alarm sounds with HI indication (abnormal high temp.)</p>	<ul style="list-style-type: none"> ▶ Check if room temperature is too high ▶ Check if incubator is exposed to the direct rays of sun ▶ In case of lowering temperature 	<ul style="list-style-type: none"> ▶ Adjust room temperature 28°C (82.4°F) ▶ Install incubator without the direct rays of sun ▶ Return incubator to factory setting [Refer to page 20]
<p>Alarm sounds with LO indication (abnormal low temp.)</p>	<ul style="list-style-type: none"> ▶ Check if room temperature is too low (especially during night) ▶ Check if incubator heater(temperature controlling-system) is normally working ▶ Please check the bottom of machine is wet or not 	<ul style="list-style-type: none"> ▶ Adjust room temperature 28°C (82.4°F) ▶ Place thermometer inside of incubator and check if setting temperature is correct ▶ Return incubator to factory setting [Refer to page 20] ▶ Please remove moisture
<p>Humidity will not go high enough.</p>	<ul style="list-style-type: none"> ▶ Check your setting humidity. ▶ Close the view window again after checking ▶ Return incubator to factory setting [Refer to page 20] ▶ Please check the surrounding temperature is too low 	<ul style="list-style-type: none"> ▶ Supply water ▶ Set the humidity again as required ▶ Please move the incubator to a warm place
<p>The machine makes some noise. * A little noisy occurs from the inside of circulation fan</p>	<ul style="list-style-type: none"> ▶ Check if there is any hatching dust such as feather or eggs-shell in the incubator fan ▶ A little noisy is not faulty 	<ul style="list-style-type: none"> ▶ Take out the plug out of the outlet and disassemble the main body and clean around the air circulation fan with brush
<p>Egg-Turning fails to work.</p>	<ul style="list-style-type: none"> ▶ Check that the Egg-turning stoppage is not activated [Refer to page 16] ▶ Check that there are no foreign items on the egg turning plate ▶ Check if egg turning plate is assembled correctly 	<ul style="list-style-type: none"> ▶ If you need to turn the eggs, you can manually re-start egg-turning ▶ Unplug the power supply and disassemble the main body for cleaning the egg turning plate and gear ▶ Assemble egg turning plate as the picture on page 10~11
<p>Dew foams in the incubator</p>	<ul style="list-style-type: none"> ▶ Check the incubator is not placed too cold circumstances ▶ When you turn OFF incubator and then turn on ▶ In case of setting high humidity 	<ul style="list-style-type: none"> ▶ Adjust room temperature 22~25°C(71.6~77.5°F) [Refer to page 12] ▶ Dew condensation is a natural phenomenon and not a malfunction of the device [Refer to the page 21]
<p>Water leaks from the machine</p>	<ul style="list-style-type: none"> ▶ Check that you have not overfilled the incubator ▶ Check that the incubator placed on inclined surface ▶ Check if it is Dew condensation ▶ When moved without taking out the water for the humidifier unit 	<ul style="list-style-type: none"> ▶ Do not fill water over LIMIT indication. ▶ Place incubator under a level surface. ▶ Remove the remaining water in the humidity unit
<p>“Err 01” appears and an alarm sounds. (Temperature / humidity sensor error)</p>	<ul style="list-style-type: none"> ▶ Please contact the customer service center 	

6. Product information

(3) Specification /
Guide to Consumer Damage Compensation

● Specifications

1-1 Name : Rcom MAX 20 DO
1-2 Model NO. : MX-20DO

2-1 Name : Rcom MAX 50 DO
2-2 Model NO. : MX-50DO

Model NO.	MX-20DO	MX-50DO
Power	AC 100~120V, 50/60Hz / AC 220~240V, 50/60Hz	
Temperature limits	20 ~ 42°C	
Working temperature	Ideal : 20 ~ 25°C (68~77°F) / MIN. : 15°C / MAX. : 30°C	
Humidity limits	30 ~ 70% (It can be changed according to the conditions)	
Egg-turning interval	Various according to the tray	
Capacity	Universal tray(Included) : Various sized egg incubation is available Rolling divider(Optional) : Various sized egg incubation is available Small egg tray(Optional) : Quail egg size 52EA Standard egg tray(Optional) : Chicken egg size 20EA Large egg tray(Optional) : Goose egg size 10EA	Universal tray(Included) : Various sized egg incubation is available Small egg tray(Optional) : Quail egg size 116EA Standard egg tray(Optional) : Chicken egg size 48EA Large egg tray(Optional) : Goose egg size 24EA
Power consumption	Average 48W MAX. 65W	Average 65W MAX. 120W
Weight	4.35Kg	6.65Kg
Size	(W)500 × (L)410 × (H)160mm	(W)633 × (L)523 × (H)171mm
Fuse standard	250V 2.0A (Ø5*20mm)	

Extension of free service is not allowed for this product. The warranty period is one year from the date of purchase.

※ How to register the product online:

1. Go to www.rcom.co.kr
2. Click on "English"
3. Sign up for membership first, then log in using those credentials
4. Click "register products"
5. Fill in all required fields and click "Save"
6. Product registration is now completed.

※ Details required to register for the guarantee:

1. The name of the product model
2. The product serial number
3. Your purchase date
4. The name of the store of purchase

● Guide to Consumer Damage Compensation

This product cannot be registered as a free service extension. The warranty period is one year.

Types of Consumer Damage	Compensation History	
	Within warranty period	After the warranty period
In case of naturally occurred failure in function or performance in normal condition of use	Free repair	Paid repair
Failure in function or performance due to intention or error of the customer	Paid repair	
<ul style="list-style-type: none"> ▪ In case of failure due to natural disaster (fire, sea wind, gas, earthquake, storm and flood) ▪ When replacing expendable part normally abraded during the use ▪ Breakdown due to abnormal power source or faulty connection device ▪ Breakdown due to repair or remodelling by person any other than the service engineer of headquarters or the service center ▪ External factors which are not defect of the product ▪ Breakdown due to use of different rating voltage ▪ Breakdown due to use of consumable, optional product not designated by the company ▪ Breakdown or loss due to drop during the transportation ▪ Breakdown for not cleaning the product ▪ Breakdown due to use of other liquid than distilled or purified water ▪ Breakdown due to use of the incubator as brooder device (developer) ▪ Breakdown due to incorrect device control ▪ Breakdown due to manner of use not mentioned in the instruction manual ▪ If the customers' fault is clear 		

 **The success of incubation may vary according to different factors. The manufacturer and distributor are not responsible for failure of incubation of costly eggs, loss of life, property damage due to negligence of user, remodeling, painting, modification of purpose of use or power failure. When incubating parrot or costly birds please verify the internal temperature (adjust) before use. Please read carefully the instruction manual before use to avoid failures.**

Rcom is designed for user's easy and convenient use.
It can be changed without notice for improvement in performance, design,
treatment and software, etc.

Ver.1.35

www.Rcom.co.kr

SELLER

MANUFACTURER

AUTOELEX CO.,LTD.

- OFFICE : 218, Sangdong-ro, Gimhae-si,
Gyeongsangnam-do, 50805 Korea
- TEL : +82-55-337-2561
- E-MAIL : sales@autoelex.com

Choose for the best design, highest quality, value and performance!