

Love of life begins with "Rcom"

DELUXE MARU

Ver. 4.2

DIGITAL EGG INCUBATOR USER'S MANUAL

MARU DELUXE PRO 100 / 200 (Slide Type)



Rcom



How to use Rcom MARU DELUXE PRO 100 / 200

1. Introduction	
(1) Rcom MARU Introduction	3 ~ 7
(2) Safety precautions	
(3) Identification of Parts and Composition	
(4) Name & Function of Operation Parts	
(5) Description of optional functions	
2. Before use	
(1) What is an Incubation Room?	8 ~ 10
(2) How to install this Incubator / Preparing for Incubation	
3. MARU Function Settings	
(1) Incubation Modes / Incubation start with Automatic Mode	11 ~ 19
(2) Incubation start with Manual Mode	
(3) Incubation start for Other Birds	
(4) Egg Turning, Humidification	
(5) How to Terminate Incubation / Reset of Incubation circum start during incubating	
(6) Room Light ON/OFF Setting	
(7) Humidifier Device OFF method	
(8) Water Shortage Detecting Function / Power Failure Alarm Function / Alerting function when the door is open	
4. Optional Functions	
(1) The Abnormal High and Low Alarm Settings	19 ~ 20
(2) How to change between Centigrade and Fahrenheit Temperature units	
(3) How to turn the backlight ON/OFF or to set the turning frequency	
(4) Sound ON /OFF	
(5) Return to Factory Settings	
5. Incubation	
(1) Humidity and Condensation principles, Air Flow considerations, and Post-Hatch maintenance	21
(2) Dew Condensation	
6. How to Clean your MARU	
(1) Instructions for Disassembling and Cleaning	22 ~ 23
7. Product Information	
(1) How to Service your Maru Replacing the Fuse, General maintenance	24 ~ 26
(2) Troubleshooting(FAQ)	
(3) Specification	

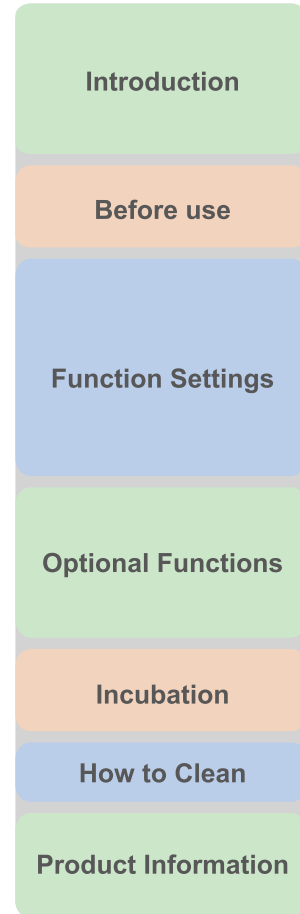

⚠ Successful hatching depends on many numbers of factors. Neither Autoelex (Rcom) nor its global distributors and vendors can be held responsible for loss of life or property damage caused by user neglect, alteration, modification or painting, change of use or power failure. To avoid errors, mishaps and danger, carefully check this User Manual before initial use. Also please check the manual regularly to ensure your operation of the machine is correct.

Mark Explanation



Caution : Caution mark against a fault that can cause damage, trouble, or failure of incubation.



Prohibited.



It is necessary to keep.



Do not disassemble.



Remove the power cord from outlet.



Do not touch.



Ground Connection for preventing electric shock.



Tip : References or useful suggestions in using Rcom product



Warning of actions which may be dangerous or cause damage to the incubator.

Rcom MARU

Firstly, we sincerely thank you for purchasing Rcom MARU incubators. It has been designed to analyze airflow using built in digital technology to maintain an optimal environment within the incubator cabinet. The incubation parameters are controlled using purpose built control systems coupled with high end sensors, all in order to permit optimum results. However, best results occur when the user, couples personal knowledge of the machine and of incubation and hatching along with observation skills with the Maru Incubators sensing, automation and control systems. The machine needs your help, good breeding flock, healthy flock diet, fertile eggs, reasonable incubation room environment and a 'clean' power supply in order to provide excellent results. User's knowledge of the machine and manage the incubator are very important. Certainly, the Maru provides an optimal incubation environment but parameters need to be managed, i.e. temperature and humidity depends on egg species, environment, and capacity. Moreover, the Rcom MARU has been carefully designed to provide an optimal setting and or hatching environment, therefore, before using the incubator, we strongly recommend that you read the manual carefully.

Features of Rcom MARU

[Main Function]

- * Convenient jog dial operation for optimized user interface
- * LCD display with incubation information, and animation graphic design
- * Micro chip with optimum incubation conditions according to the species of birds, for incubation beginners
- * Manual setting Mode for incubation specialists
- * Superior design with convenient operation
- * Integrated simple control panel (superior maintenance)
- * Automatic temperature & humidity control and set function
- * Automatic egg turning & turning interval set function (1h, 2h, 3h)
- * LCD display for easy recognition of incubation state
- * Artificial intelligence electronic control system by Rcom technology
- * Precise temperature and humidity sensor produced by Sensirion, Swiss (ver. 3rd Generation of Sensirion, Swiss)
- * Transparent double insulated viewing window
- * Sliding vent to in the chamber
- * Dependable temperature by Rcom optimum air flow technology
- * Innovative PTC Heating Type humidifier eliminates bacteria from humidity reservoir
- * Built-in water level sensing switch automatically detect the water level inside the humidifier and alarm water refill is required
- * Increased temperature stability and energy efficiency due to high-density insulated body developed by Rcom
- * Built-in 'open door' micro-switch detection
- * Option to select ON/OFF function each of eggs on the universal tray

[Useful Function]

- * Degree C / degree F interchangeable
- * Self-examination function for sensing abnormal conditions
- * Separate humidifier not required due to built-in humidifier unit within the device
- * Warning & display function of abnormal temperature caused by ambient temperature fluctuation
- * Incubation data memory and alarm function in case of blackout
- * Equipped with water nipple in front for efficient water supply
- * Equipped with removable upper cover for convenience of cleaning or maintenance after incubation
- * Built in LED dome-light for ease of viewing when door is open
- * Universal tray sliding device for uniform egg incubation
- * Automatic egg rotation at any angle carried out by tray carrier filler
- * Adjustable universal tray and aluminum dividers suitable for most egg sizes

Electrical hazards

CAUTION Be careful the details below when you use.

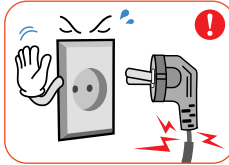

Do not use a damaged power cord or loose outlet.
▶ Risk of electric shock or fire.

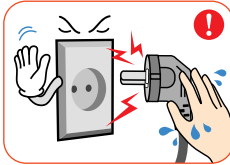

Do not pull the cord when taking out the power cord, and keep wet hands away from connecting plug.
▶ Risk of electric shock or fire.

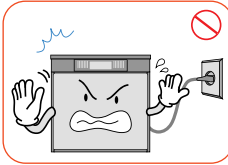

Never pull the plug out of the outlet during the incubation period.
▶ Incubation will be interrupted.

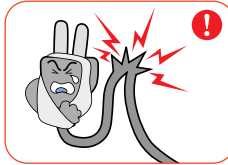

Do not twist or crush electric cord.
▶ Risk of electric shock or fire.

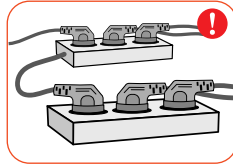

Do not insert multiple connecting plugs in an outlet.
▶ Risk of fire or electrical overload.

Setting Cautions

CAUTION Be careful the details below when you use.



Do not install in dusty or dirty environment.
▶ Risk of damage or fire within the incubator.

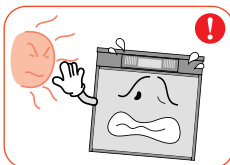

Do not install under the direct sunlight.
▶ Risk of fire or interference with the incubation process.

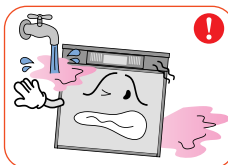

Do not install in moist or humid environment.
▶ Risk of fire or electric shock.



Do not install in excessively cold or hot conditions, cigarette smoke, etc.
▶ Risk of interference with the incubation process.

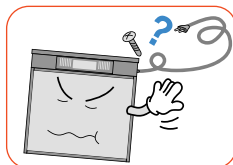

Do not use any other non-standard parts except those provided.
▶ Risk of damage or hatching failure.

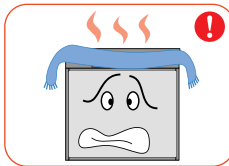

Do not cover the ventilating opening.
▶ Inner temperature can rise, interrupting incubation.

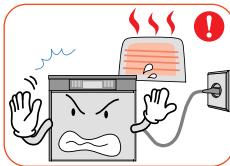

Install away from heat sources.
▶ Risk of damage to the incubator case and interference with the incubation process.



Ensure that the incubator is installed on a stable surface away from edges.
▶ Risk of damage to incubator and eggs and user from accidental knocks or drops.

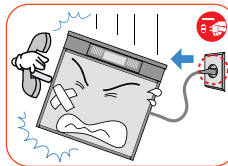

If the incubator requires repair disconnect from the power supply and please contact to your service center.

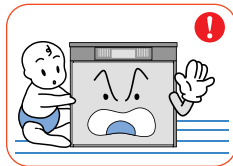

Children should be supervised to ensure that they do not play with the appliance.
▶ Risk of knocking the incubator or accidental interference with the controls.

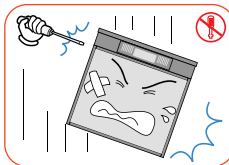

Do not disassemble or modify the incubator in any way.
▶ Risk of electric shock or fire.



Please ensure that no small objects get into the holes on the incubator.
▶ Risk of electric shock or fire.

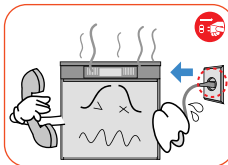

If the incubator sounds strange or emits smoke contact your service center.
▶ Risk of electric shock or fire.

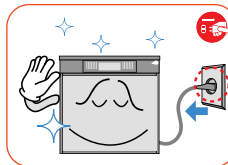

Clean the incubator thoroughly before storing.

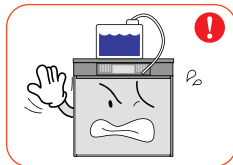

Do not place water container on the incubator

Cleaning Cautions

CAUTION Be sure to disconnect the electric cord from the outlet before cleaning.

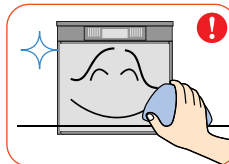

Clean the incubator by a soft cloth with a neutral detergent.



Brush away dust on the plug with a dry cloth.

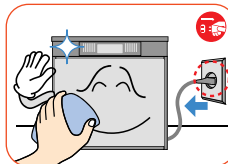

Do not use chemicals like wax, benzene, alcohol, thinner, aromatic, or lubricant, etc.

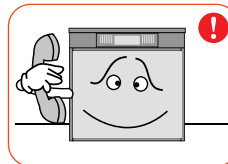

For special cleaning of inner part per year, contact to the service center.
▶ If you don't clean the inside of incubator for a long time, dust can cause some trouble or a fire.

Identification of Parts

Serial NO is located on the upper front cover. (ex. RCM0000000) is a product specific number.

Rcom MARU DELUXE PRO 100 / 200 (*Below is the image of MAX 200 model.)



Basic Components

Rcom MARU DELUXE PRO 100 / 200



Manual



Power Cord

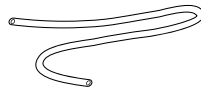

Silicon Tube : 1.5M (Diameter: Ø4*6)



Driver



Lubricant

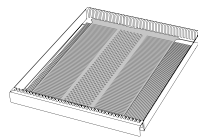

Universal Tray
MARU 100 2EA
MARU 200 4EA

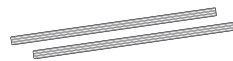

Aluminum Divider
MARU 100 14EA
MARU 200 28EA
※ Extra aluminum divider can be purchased separately

Name & Function of Operation Parts

Rcom MARU DELUXE PRO 100 / 200

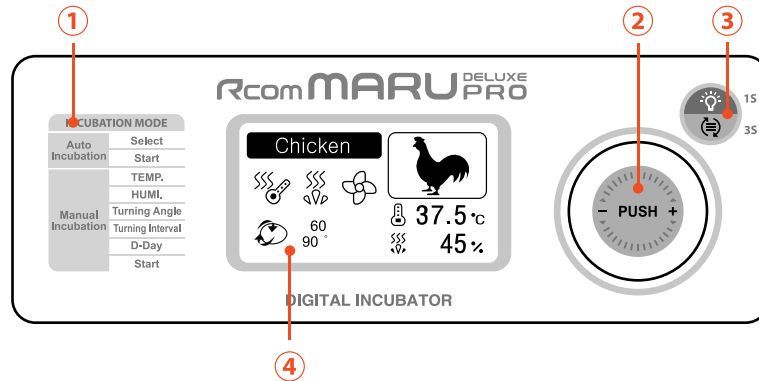







● Names and components of each part

- ① **Function Table** : Function can be selected in order by using the jog dial
- ② **Jog Dial** : Press and turn around to left and right
 - Function setting mode will appear when pressed for 3 seconds
 - Temp. and humidity can be checked when pressed for 1 second
- ③ **Room Light Button (1 second) / Forced egg turning button (3 seconds)** - The incubator turns eggs 1 time for artificial incubation.
- ④ **On screen** : Incubation conditions are displayed.

ICON	NAME AND FUNCTION	ICON	NAME AND FUNCTION
<p>Bird Icon Display</p>	**Choose a bird** * Chicken ① * Duck ② * Quail ③ * Pheasant ④ * Peacock ⑤ * Goose ⑥ * wildgoose ⑦ * G-Pheasant ⑧ * Turkey ⑨ * Other Birds ⑩		Egg Turning Indication Manual Egg Turning Stop Indication Automatic Egg Turning Stop Indication Incubation Termination
	Species of Birds		FAN Operation Display
	Current Temperature Display / Temperature Abnormal Display		Heater Stop Display / Heater Operation Display
	Current Humidity Display / Humidification function OFF		Humidification Stop Display / Humidification Operation Display
	Egg Turning Interval Indication(minute) / Egg Turning Angle Indication		Water Supplement / Humidity Abnormal
	Cooling Function Display		Alerting function when the door is open
			Power Failure Notification

Description of optional functions

<p>T.CAL (Temperature Calibration)</p>		<div style="display: flex; align-items: flex-start;"> <div style="border: 1px solid black; padding: 2px; margin-right: 10px;"> <p>WARNING Fatal Damage with Incorrect Calibration!</p> </div> <p>! Be sure to read CAUTIONS. We do not recommend customers to recalibrate by their own. If you need to recalibrate, please ask purchase place.</p> </div>
<p>H.CAL (Humidity Calibration)</p>		<div style="display: flex; align-items: flex-start;"> <div style="border: 1px solid black; padding: 2px; margin-right: 10px;"> <p>WARNING Fatal Damage with Incorrect Calibration!</p> </div> <p>! Be sure to read CAUTIONS. We do not recommend customers to recalibrate by their own. If you need to recalibrate, please ask purchase place.</p> </div>
<p>ALARM (Abnormal High Alarm)</p>	<p>High Temp</p>	<p>Alarm sounds when incubator temp. is higher than setting value because of room temp. change or heating system disorder <i>* Setting Range : 0.0°C ~ 5.0°C (Default Setting : 2.0°C)</i></p>
<p>ALARM (Abnormal low Alarm)</p>	<p>Low Temp</p>	<p>Alarm sounds when incubator temp. is lower than setting value because of room temp. change or heating system disorder <i>* Setting Range : 0.0°C ~ -5.0°C (Default Setting : -3.0°C)</i></p>
<p>Unit</p>		<p>Selecting Centigrade (°C) and Fahrenheit (°F) <i>* Default Value : Centigrade (°C)</i></p>
<p>Light</p>		<p>LCD Backlight management setting <i>* Always On : Always BackLight On * Always Off : Always BackLight Off</i> <i>* Event On : 20 Sec. ON with Key input * Default Value : Always On</i></p>
<p>Sound</p>		<p>ON/OFF Setting for Melody, other alarms <i>* Default Value : ON</i></p>
<p>ALL RESET (Factory setting)</p>		<p>It returns to factory setting when you change the initial setting at discretion.</p>
<p>Info</p>		<p>Basic information of Incubator (version Indication)</p>

What is an Incubation Room?

The Incubation Room is a confined space for setting and operating an incubator efficiently. An Incubation Room environment has a considerable effect on hatch rate. Controlling the incubator environment is recommended; there should be little noise or vibration and constant temperature ranging upwards from 28°C(82.4°F) with small variation in temperature. For optimum performance, pay attention that your incubator isn't exposed to temperature drops compared with daytime. Do not directly exposed the incubator to sunlight during daytime. also, please incubator where direct wind from air-conditioner not to reach.

⚠ If you set a high temperature, condensation will occur and may causes water to leak from the incubator and it which is not a technical problem. You need to keep temperature between 28°C (82.4°F).

How to Install this Incubator

- ▶ Please set the incubator horizontally on a stable, tallish table (50[cm] or above)
- ▶ Ensure the incubator is completely level, so the door can close completely.
- ▶ Connect silicon tubing onto the nipple of incubator, and the other end of silicon tubing into a water container.

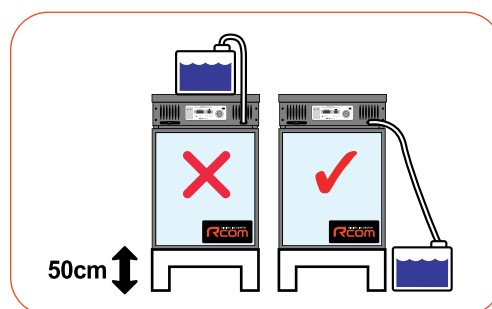

⚠ Do not place water container on top of the incubator. It may flood the humidity unit.

⚠ Using tap water or underground water instead of distilled water in this unit's humidification device will cause serious debris (scale) to develop. In this case, the inconvenience of frequent cleaning will occur and when left alone, may become the cause of malfunction or breakage. If you have any questions regarding such problems, please contact the place of purchase and failure of the device due to the consumer negligence (due to non-cleaning), even if it occurred with in the free A/S period, repair charges might occur when repairing, so use of distilled water is highly recommended.

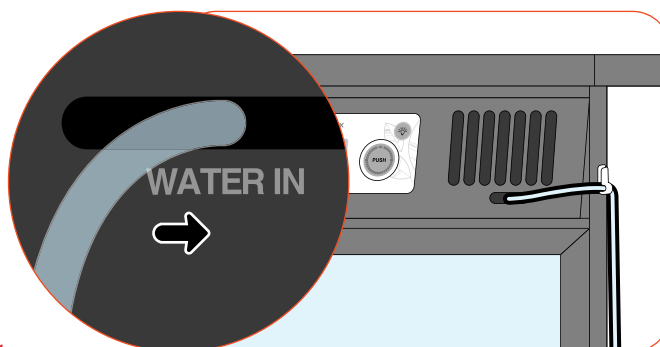

Preparing for Incubation

[Egg tray assembling method]

- ▶ Remove the cable ties fixed to both sides of the egg tray of each shelf (shown in figure ㉓ below).
- ▶ Before supplying power, make sure that the filler bar (shown in figure ④ below) located in the universal tray slide plate is inserted in the middle of the carrier frame (shown in figure ③ below).

⚠ If cable ties are not removed, egg-rotation problems or malfunctions may occur.

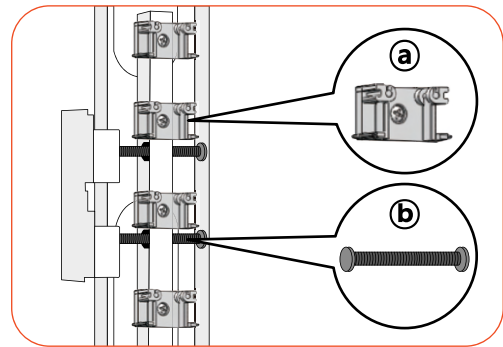
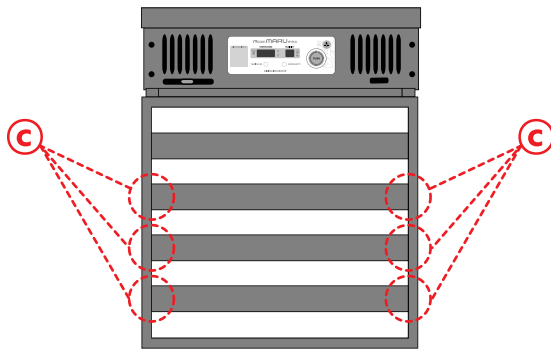

[Egg Rotating Device]

㉓ : Carrier Frame ㉔ : Moving Screw

- ▶ 2 frame fillers are installed on one carrier frame.
- ▶ The Carrier filler shown in figure below is factory assembled so no assembly is required.

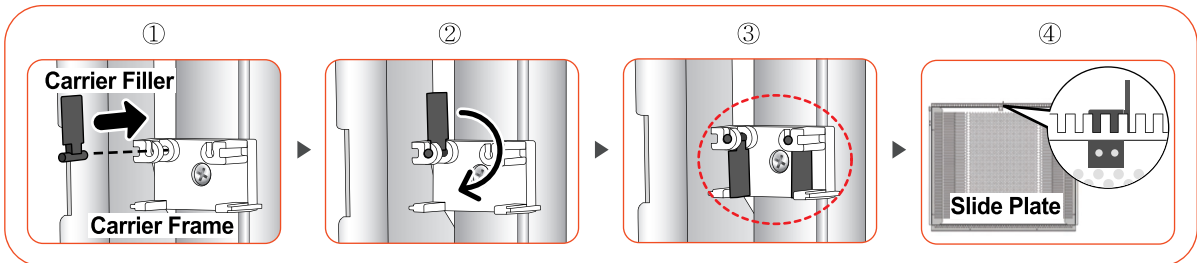

⚠ If the door isn't completely closed, the temperature and humidity might not be controlled, so be careful. If water is on the machines floor, it will not reach operating temperature. (Do not place the humidifier water tank on top of the machine.)

Tip More eggs could be inserted if sorted by similar size.

Tip The eggs intended for incubation must be fertilized eggs.

- ▶ A slight gap (about 2mm) is required, between egg and aluminum divider (as shown in the figure), this allows smooth egg turning.

⚠ Please turn on the device and make sure that all functions are properly operating before putting in the eggs.

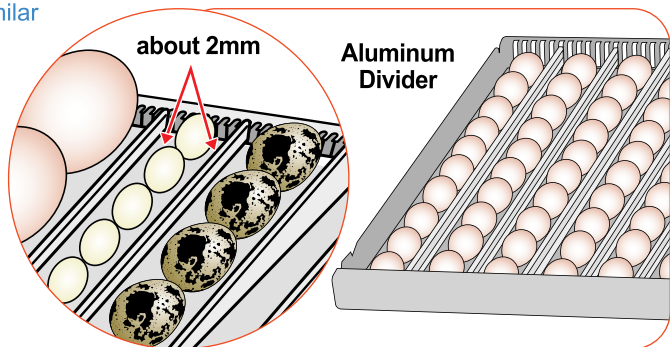

- ▶ When the power cord is plugged in and turned on the digits on the temperature and humidity FND appears, then Temperature and Relative Humidity will increase a little. (Their default value is respectively : 37.5°C (99.5°F) and RH 45%) A initial smell may be noticed this is to be expected.

 Do not connect power supply before the incubator is assembled completely.
Risk of electric shock.

- ▶ Please check and refill distilled water every 2 days during incubation. Or as needed (If the water tank is small, please check every day.)

 If you use the incubator without adding humidification water or intend to incubate eggs at low humidity under RH 30%, you must stop the humidification function. Please turn off the humidity function if there is no water available otherwise the humidity unit will fail, making the machine unuseable.
(When using this function, the alarm for sensing wter drop will go out.) [Refer to the page 18]

※ To turn off the Humidification Function : Set humidity under RH 30%.

 **Using tap water or underground water instead of distilled water in this unit's humidification device will cause serious debris (scale) to develop. In this case, the inconvenience of frequent cleaning will occur and when left alone, may become the cause of malfunction or breakage. If you have any questions regarding such problems, please contact the place of purchase and failure of the device due to the consumer negligence (due to non-cleaning), even if it occurred with in the free A/S period, repair charges might occur when repairing . so use of distilled water is highly recommended.**

 You can buy the 'Distilled water' in your local market, and if you have any question, please contact the shop, where you purchased your machine.

Incubation Modes

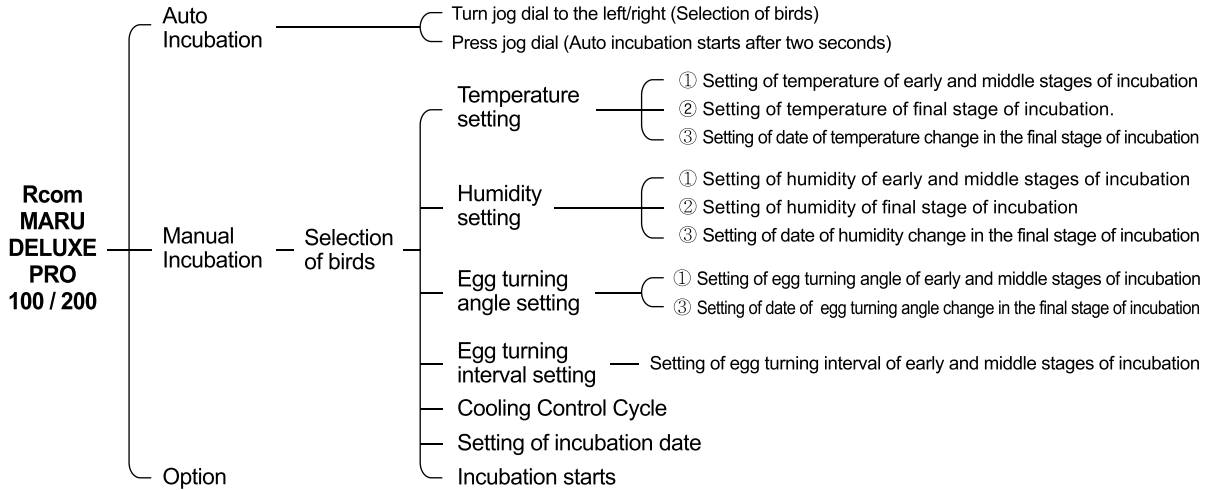

▶ If you press the jog dial for 3 seconds while on operation, "Finish Incubation / Change Settings / Option" appear on the screen.

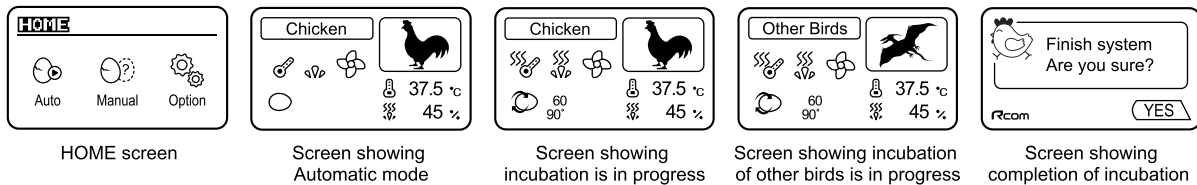

Incubation start with Automatic Mode

The optimum incubation environment of the birds on the menu screen is memorized in the micro chip. User can incubate easily using by this function.

- ▶ turn the jog dial to the left and right at the initial setting and select "Auto Incubation", and then press jog dial. This way, you can set auto incubation conditions.
- ▶ If you turn the jog dial to the left and right to select the type of birds and press the dial for a moment, the message "Start system Are you sure?" comes up. Select "YES" by turning the jog dial to start auto incubation, or select "NO" to go back to the previous page. Or, select "Home" to go back to the main page.

When choosing the type of birds, press the jog dial for 2 seconds to skip "YES/NO" and start auto incubation.

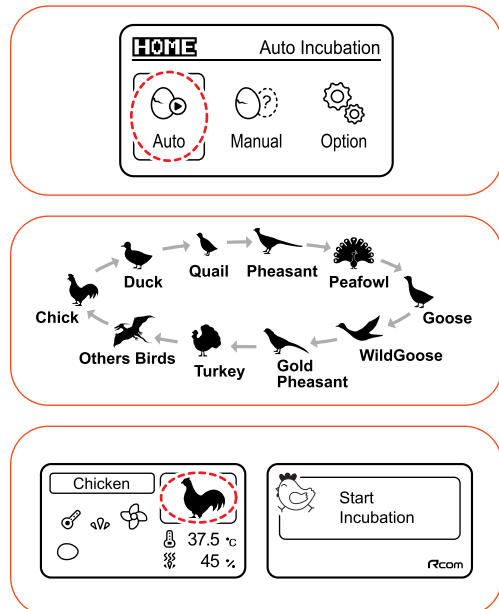

Tip In auto incubation, user only needs to select type of birds as incubation environments such as optimum temperature, humidity, egg turning, etc. are automatically controlled. User can change incubation environments if needed.

Incubation start with Manual Mode

This mode helps users to set temp. humidity, and egg turning etc. according to their needs. This mode is ideal for those persons who are experienced in incubation.

- ▶ At the initial setting, turn the jog dial to the left and right to select "Manual Incbtn" and then press the dial. This way, you enter the manual incubation setting mode.
- ▶ If you press the job dial once again on the manual incbtn setting mode, a list of bird types comes up. Select the type you want by turning the jog dial to the left and right and then press it. In the case you want to go back to the previous page, select "BACK".

Tip If there is no proper option, please select option other bird, Refer to the Page14.

- ▶ Following the steps below, set temperature, humidity, angle, turning Interval, cooling control cycle and incubation date you want by turning the jog dial to the left and right. Then, press the dial to save the settings and move on to the next step.

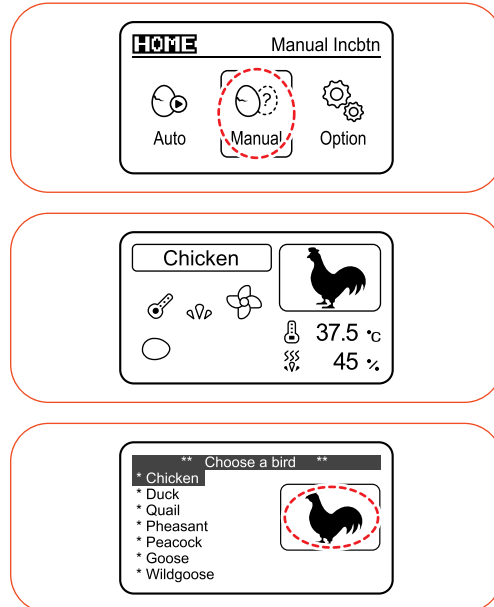

※ Press "PUSH" for 3 seconds while setting **STEP1**~**STEP3** to choose among "Home / One step back / Save & Start".

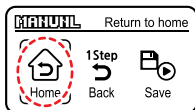

Return to home
: Go back to the main page



One step back
: Go back to the previous step

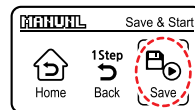

Save & Start
: Save the settings and start incubation

STEP1 Temperature setting

- ① Setting of temperature of early and middle stages of incubation.
- ② Setting of temperature of final stage of incubation.
- ③ Setting of date of temperature change in the final stage of incubation.

- ▶ Optimum incubation temperature of general birds at early and middle stages ① is 37.5°C, and the temperature of final stage ② is better to set at 37°C three days before the expected date of hatching (D-Day) ③. User can optionally change the temperature of early, middle, and final stages of incubation.

[Default settings: ① 37.5°C, ② 37.0°C, ③ 3days]

Tip At the final stages of hatching (from 3 days before hatching), temperature inside eggs stay relatively high. At this stage, keep the hatching temperature approximately 0.5 °C lower than usual.

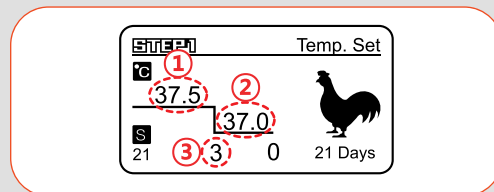

[Temperature Setting]

STEP 2 Humidity setting

④ Setting of humidity of early and middle stages of incubation.

⑤ Setting of humidity of final stage of incubation

⑥ Setting of date of humidity change in the final stage of incubation.

▶ The optimum humidity depends on type of birds. However the humidity of final stage ⑤ (3 days before incubation) is generally higher than that of early and middle stages ④ of incubation.
[Default settings: ④ 45%, ⑤ 60%, ⑥ 3days]

Tip It is recommended to raise the humidity setting to over 65% from 1~3days before hatching.

Tip The temperature and humidity level is optimized according to the international standard at the time of shipping. It could be recalibrated by the user if the user wishes to do so, but this is not recommended. When in need of adjustment, please refer to our homepage (www.Rcom.co.kr → Information → User Manual Category) or contact the place of purchase. Commercially available thermometer and hygrometers may have drastic measurement deviations, so it is recommended to use thermometer and hygrometer designated for this purpose. [Designated Thermometer and hygrometer – Refer to Rcom Homepage]

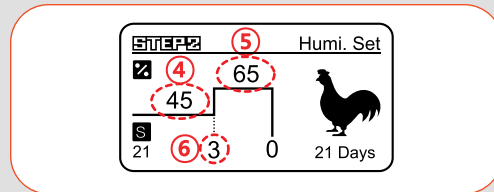

[Humidity Setting]

STEP 3 Egg-turning angle setting

⑦ Setting of egg turning angle of early and middle stages of incubation.

⑧ Setting of date of egg turning angle change in the final stage of incubation.

▶ The egg turning angle showing on LCD screen may be different from the setting angle depending on egg tray (based on standard egg tray) and size of eggs. In general, the egg turning angle of early and middle stages is 90° for chicken, golden pheasant, pheasant. It is better to set higher angle (110 ~180°) for bigger eggs and wild birds. It is a general practice not to turn eggs (turn angle is 0°) at final stage of incubation (3 days before expected hatching date).

Tip When "rnd" (Random) is set, the egg turning angle is between 75~180° at random. (Egg turning angle setting range : 0°, 15°, 30°, 45° · · · · · , 150°, 165°, 180°, rnd)

! If having difference for the egg turning angle between display and actual operating, Please find and select the proper angle.

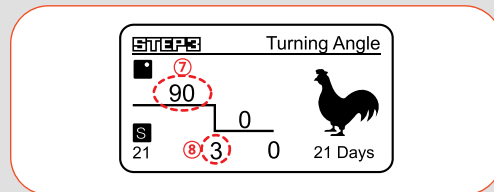

[Egg Turning Angle Setting]

STEP 4 Egg turning interval setting

⑨ Setting of egg turning interval of early and middle stages of incubation.

▶ It is a function to set the interval (time) of egg-turning ⑨. It turns the eggs with the setting angle of early and middle stages ⑦ every 60min. User can optionally set the egg-turning interval ⑨ of eggs. [Initial Setting: ⑨ 60min.]

Tip "rnd"(Random) setting is for operating at random within the limits from 10min. to 360min. (Egg turning interval setting range: rnd, 10, 20, 30, 40 · · · · · 340, 350, 360min.)

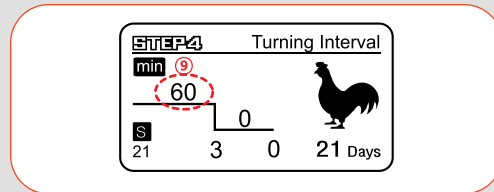

[Egg Turning Interval, Incubation Date Setting]

▶ Setting of incubation date: The incubation date of birds on menu screen is a general incubation date. User can input the correct incubation date. [Initial settings: depending on type of birds]

※ Incubation date setting cannot be changed during incubation.

STEPS Cooling control cycle setting

⑩ Setting of cooling control cycle.

- ▶ It is a function which cools during the setup time among the 24 hours of a day.
[Default settings: ⑩ : off]

Tip The periodic cooling is helpful for successful hatching but you might need preliminary knowledge to perform the cooling control process.
(Cooling control cycle setting range: off, 10, 20, 30 . . . 340, 350, 360min.)

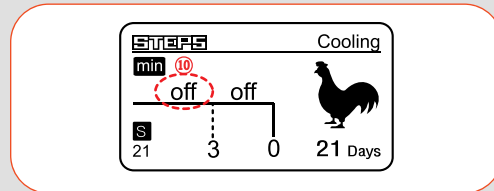

[Egg Turning Interval]

STEPS Setting of incubation date

⑪ Setting of incubation date.

- ▶ Setting of incubation date: The incubation date of birds on menu screen is a general incubation date. User can input the correct incubation date.
[Initial settings: depending on type of birds]

※ Incubation date setting cannot be changed during incubation.

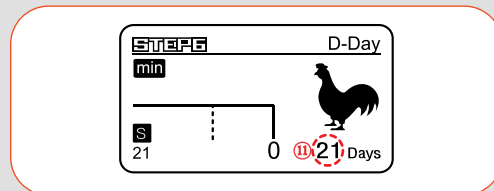

[Incubation Date Setting]

[Setting Finish and Incubation Start]

- ▶ At the final step, if you press the job dial after setting the D-day for hatching, the message “Start system Are you sure?” comes up. Select “YES” by turning the jog dial to start the auto incubation, or select “NO” to go back to the previous page. Or, select “Home” to go back to the main page.

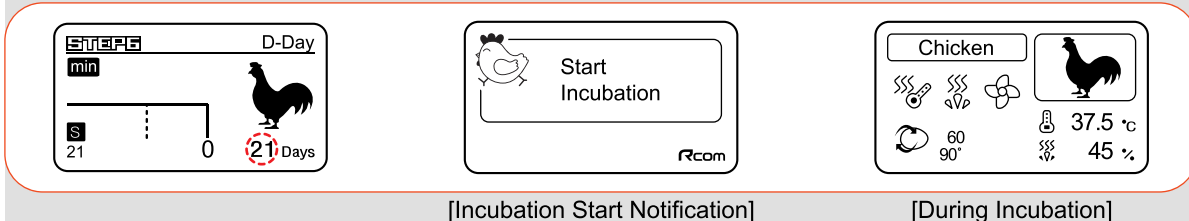

[Incubation Start Notification]

[During Incubation]

Incubation start for Other Birds

This function is used when user wishes to incubate other birds which are not memorized in the incubator menu setting. User can change incubation conditions according to needs.

- ▶ At the initial setting, turn the jog dial to the left and right to select “Manual Incbtn” and then press the dial. This way, you enter the manual incubation setting mode.

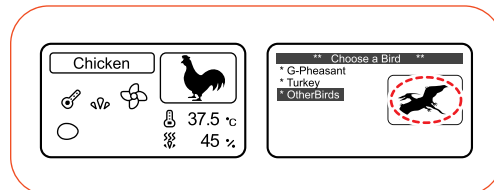
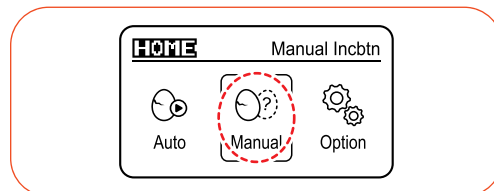

▶ press the jog dial once again on manual incbtn setting mode to see a list of the types of bird. select "Other Birds" by turning the jog dial to the left and right then, press it enter into "Incubate setting"

▶ After setting the D-Day for hatching, set temperature, humidity, angle, turning interval and cooling control cycle you want by turning the jog dial to the left and right then press the jog dial to save the settings. Refer to the Page12~13.

▶ How to set repetitive incubation: when setting the D-day, if you turn the jog dial to the left and right up to D-50Days and turn the dial once again, "?" mark comes up. Then, press the jog dial for 2 seconds to set repetitive incubation.

Tip WHAT is repetitive incubation?
It is a function that allows you to operate the egg incubator repetitively with the same incubation conditions you already set, regardless of the days hatching takes.

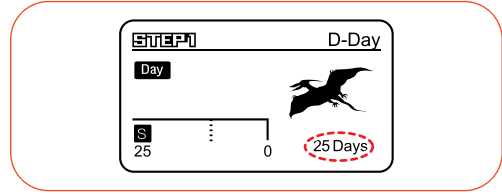

[D-day Setting]

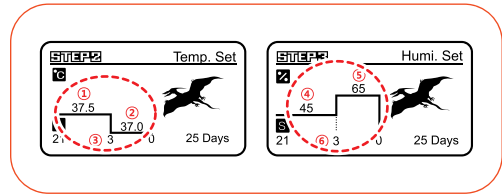

[Temperature / Humidity Setting]

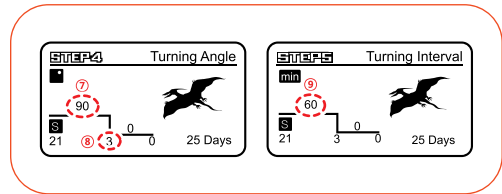

[Egg Turning Angle Setting / Egg Turning Interval Setting]

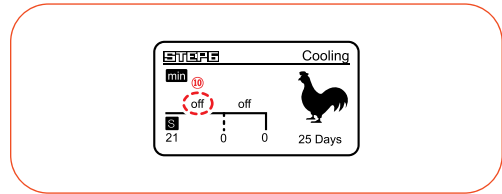

[Cooling Control Cycle Setting]

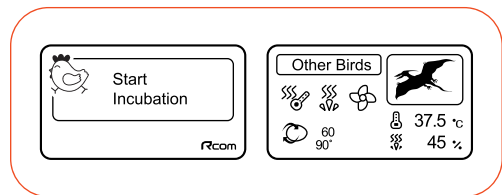

[Incubation Start Notification / During Incubation]

※ Press "PUSH" for 3 seconds while setting Incubation conditions to choose among "Home / One step back / Save & Start".

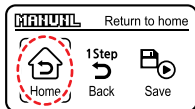

Return to home : Go back to the main page

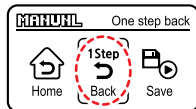

One step back : Go back to the previous step

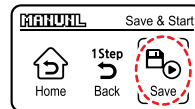

Save & Start : Save the settings and start incubation

Egg Turning

▶ **Make sure you stop egg turning and remove the dividers 3 days prior to hatching. In the case of auto incubation, the egg turning stops automatically 3 days before hatching.**

▶ Forced egg tray turning method : By pressing forced turn button () for 3 seconds, turning will occur once.

! It is recommended to hatch in special hatching room. Hatching chickens in a Incubator are exposed to the risk of falling from egg trays or being caught in mechanisms which may cause their death occasionally. Please don't forget to turn off the turning function during hatch. [Hatching separately in a specialist hatching machine is recommended, i.e the Rcom Hatcher & Brooder – Rcom Maru H&B 380, in this may your incubator is easier to maintain, hatching chicks are separated from incubating eggs (good health)]

Tip It is recommended that turning should be stopped 3 days before hatching day.

- ▶ The Rcom Maru sliding type model allows each layers egg turning to be separately turned off.
- ▶ By slightly pulling the handle of the each layer forward, as shown in the figure, egg turing function in the corresponding layer can be set to OFF.
- ▶ Try to balance weights egg numbers and weight in egg trays to avoid straining the machine.

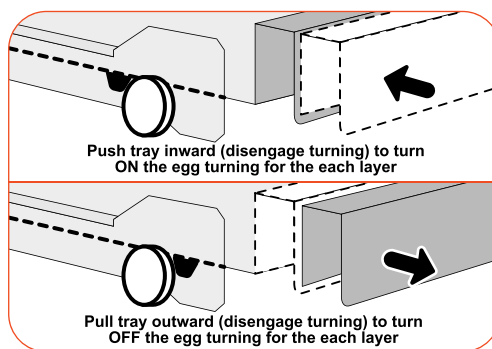

[Good example for stopping turning of each layer] o : turning, x : Stop turning

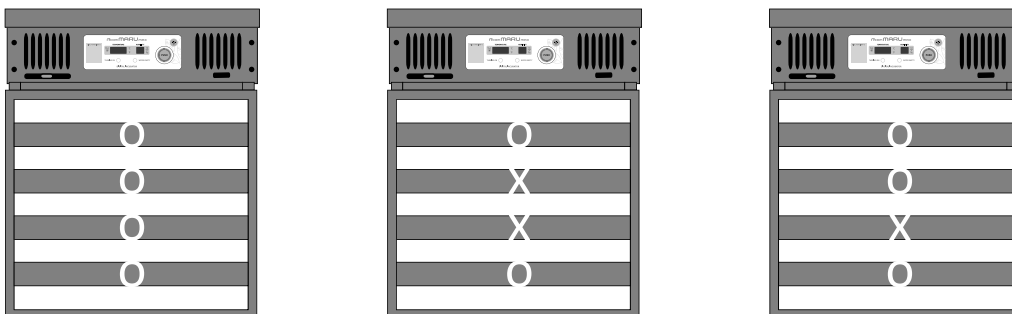

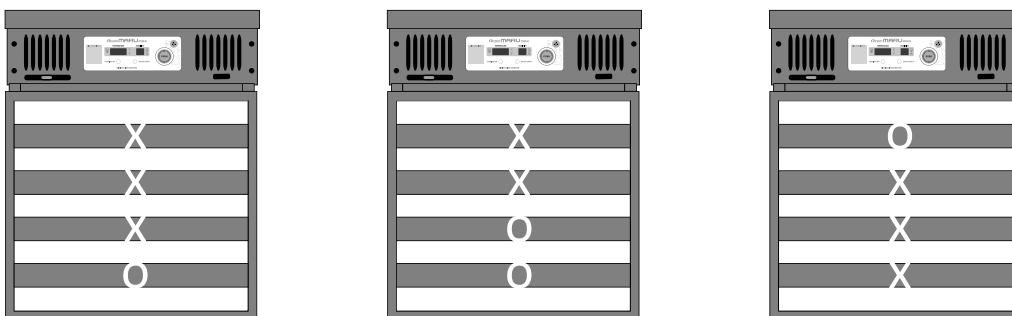

[Bad example for stopping turning of each layer] o : turning, x : Stop turning



Humidification

- ▶ All kinds of bird need over RH 65% humidity during the period prior to hatching.
- ▶ Pumping Motor Test Method: During the operation of the machine, pressing the jog dial 3 times shortly will operate the pump motor.

 In case of water shortage, it works. When the inside of the incubator is filled with water, the pump motor works for 0.5 second. (Check motor working sound)

 Please turn off the humidity unit if the unit is empty water otherwise, humidity unit will be broke or you may not no longer use the unit. So please turn off the humidity unit. [Refer to the page 17]

 **Using tap water or underground water instead of distilled water in this unit's humidification device will cause serious debris (scale) to develop. In this case, the inconvenience of frequent cleaning will occur and when left alone, may become the cause of malfunction or breakage. If you have any questions regarding such problems, please contact the place of purchase and failure of the device due to the consumer negligence (due to non-cleaning), even if it occurred with in the free A/S period, repair charges might occur when repairing . so use of distilled water is highly recommended.**

How to Terminate Incubation

- ▶ Press the jog dial for 3 seconds while on incubation to choose among "Finish Incubaiton / Change settings / Option / Back".
- ▶ If you select "Finish Incubation" by turning the jog dial and press it, the message "Finish system Are you sure?" comes up.
- ▶ Select "YES" by rotating the jog dial to the left and right, and press it to finish incubation, going back to the main page. Select "NO" and press the jog dial if you want to go back to the previous page.

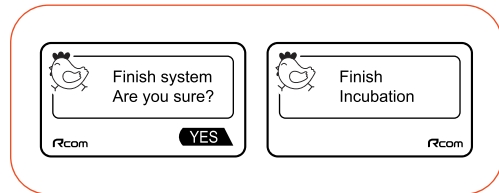
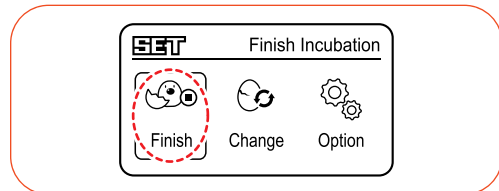

[Incubation Termination]

Reset of Incubation circum start during incubating

- ▶ Press the jog dial for 3 seconds while on incubation to choose among "Finish Incubaiton / Change settings / Option / Back".
- ▶ turn the jog dial to select "Change Settings" and press the jog dial. Then, the temperature setting page blinks.

If you want to adjust temperature, turn the jog dial to the left and right of reset the temperature. Then, if you press the jog dial, the settings are saved with alerting message /sounds and you move on to the next step.
(Adjust settings in the following order: temperature→humidity→angle→turning interval)

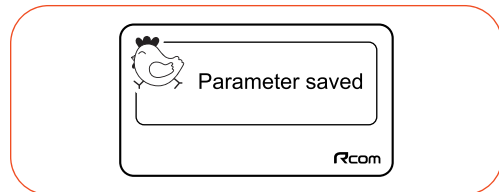
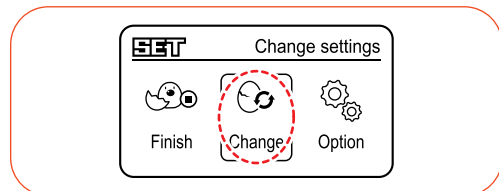

[Setting Save Message]

※ If you press "PUSH" while setting incubation conditions, you can choose between "Quit/Save & Quit".

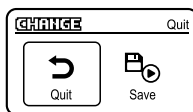

Quit
: Do Not Save Settings and Move On To The Incubation Page.

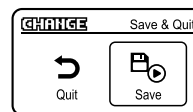

Save & Quit
: Save Settings and Move On To The Incubation Page

3. MARU Function Settings

(6) Room Light ON/OFF Setting
 (7) Humidifier Device OFF method
 (8) Water Shortage Detecting Function / Power Failure Alarm Function / Alerting function when the door is open

MARU

Room Light ON/OFF Setting

- ▶ When you press the cabinet light button, you can ON/OFF the room light. [Default Value : OFF]
- ▶ When the door is open, the cabinet light turns on, when the door is closed, the light is OFF.

⚠ Leaving the lamp on for a long period of time is not good for incubation.

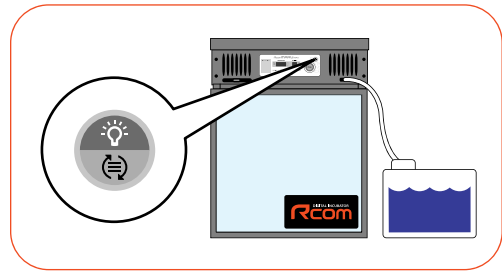

Humidity Settings and Humidifier Device OFF method

- ▶ If you use the incubator without adding humidification water or intend to incubate eggs at low humidity under RH 30%, you must stop the humidification function.
- ▶ Press the jog dial for 3 seconds while on incubation to choose among "Finish Incubation / Change settings / Option / Back".
- ▶ turn the jog dial to select "Change Settings" and press the jog dial. Then, the temperature setting page blinks.

If you press the jog dial when the temperature setting page is blinking, the humidity setting page blinks. Then, lower humidity until "OFF" sign is shown by turning the jog dial to the left and right and press the jog dial for 3 seconds to turn humidification function off, moving on to the incubation page. On the other hand, if you adjust humidity to over RH 30%, the humidification function is turned on. (Default Setting: ON)

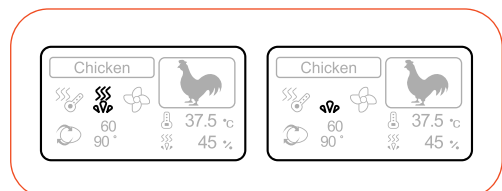
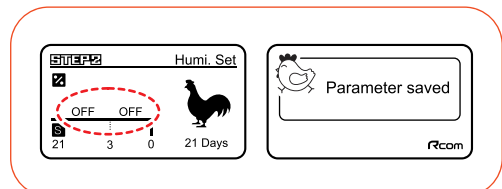
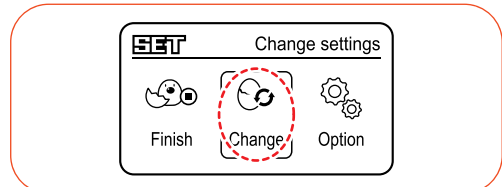

[Humidification ON / Humidification OFF]

Water Shortage Detecting Function

- ▶ When water is running low, the water drop shaped "HUMIDITY" mark on the main page turns from → and an alerting message pops up with alerting sounds every 3 minutes.

⚠ It takes several minutes to get back to normal state once water is supplied.

- ▶ Lasting water shortage makes that humidity display is changed to → the abnormal state and the alarm is ringing. (Check humidity unit and refill water)

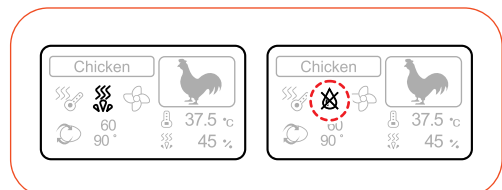
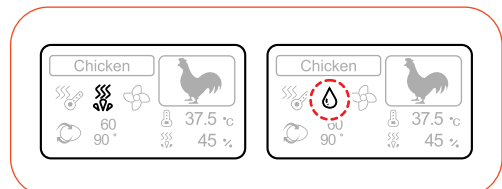

Power Failure Alarm Function

- ▶ When you first switch on the power, or in case of power failure during incubation, display shows this icon and incubator and incubator alarm sounds for about 10sec. Press ENTER to remove.

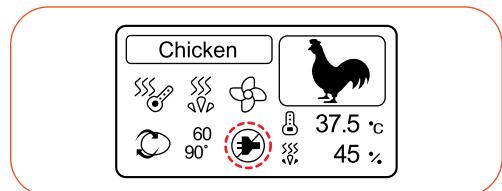

Alerting function when the door is open

- ▶ If the door is open for over 30 seconds during operation, the “Door Opened” icon pops up with alerting sounds. The icon disappears immediately if the door is closed.

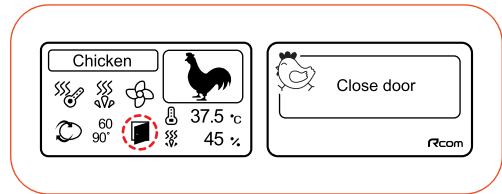

The Abnormal Low Alarm Settings (Option function)

- ▶ WHAT is an abnormal temperature alerting function?
It is a function that alerts the user to an abnormally high or low temperature inside the incubator.
- ▶ When incubator temperature is different from setting value, icon is changed → , and display indicates current temp. and temp. difference alternatively.

! The alerting sounds set off for 1 minute and automatically stops. The alerting sign stays on until the jog dial is pressed.

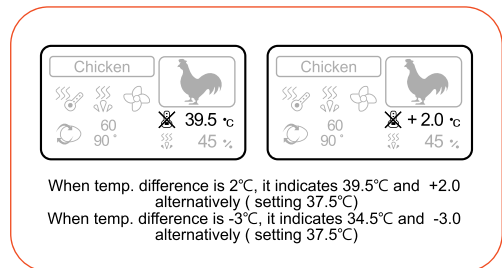

[How to Set Abnormal High Temp. Setting]

: When incubator temp. is higher than setting temp.

- ▶ Setting Range: 0.0°C ~ 5.0°C, Default Setting : 2.0°C
- ▶ Press the jog dial for 3 seconds to see the menu and turn the dial to the left and right to select “Option”. Then, press it again to enter the option mode.
- ▶ On the option mode, turn the jog dial to the left and right to select “High Temp. Set”, and press the jog dial to enter the “High Temp. Set” mode. Then, adjust the setting by turning the jog dial to the left and right. Now, press the jog dial to save the settings.

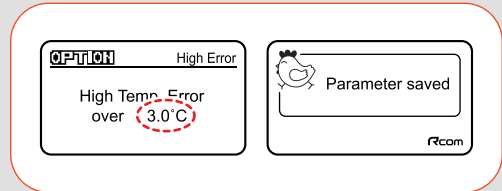
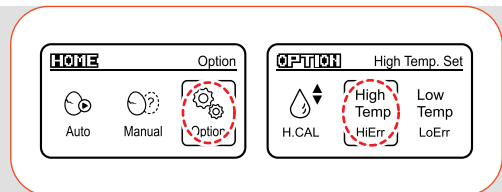

[How to Set Abnormal Low Temp. Setting]

: When incubator temp. is lower than setting temp.

- ▶ Setting Range: 0.0°C ~ - 5.0°C, Default Setting : - 3.0°C
- ▶ Press the jog dial for 3 seconds to see the menu and turn the dial to the left and right to select “Option”. Then, press it again to enter the option mode.
- ▶ On the option mode, turn the jog dial to the left and right to select “Low Temp. Set”, and press the jog dial to enter the “Low Temp. Set” mode. Then, adjust the setting by turning the jog dial to the left and right. Now, press the dial to save the settings.

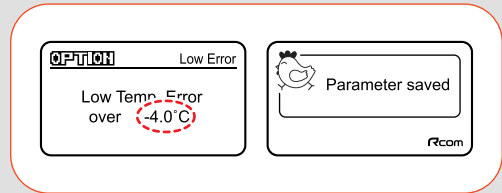
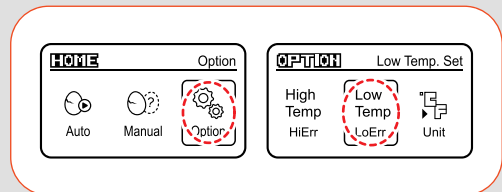

4. Optional Functions

(2) How to change between Centigrade and Fahrenheit Temperature units
 (3) Hot to turn the backlight ON/OFF or to set the turning frequency
 (4) Sound ON/OFF (5) Return to Factory Settings

MARU

How to change between Centigrade and Fahrenheit Temperature units (Option function)

- ▶ Press the jog dial for 3 seconds to see the menu and turn the dial to the left and right to select "Option". Then, press it again to enter the option mode.
- ▶ On the option mode, turn the jog dial to the left and right to select "Temp. Unit", and press the jog dial to enter the "Change Temp. Unit" mode. Then, enter "Temp. Unit" mode by pressing the jog dial.
- ▶ On the "Temp. Unit" mode, turn the jog dial to the left and right to select Celsius or Fahrenheit. Now, press the jog dial to save the settings. [Default Setting: Celsius : °C]

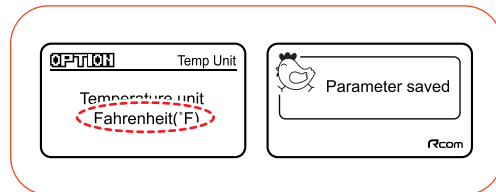
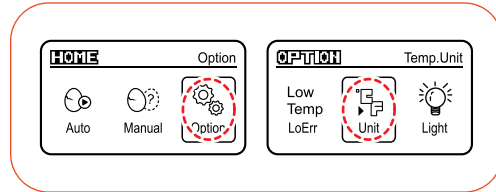

Hot to turn the backlight ON/OFF or to set the turning frequency (Option function)

- ▶ Press the jog dial for 3 seconds to see the menu and turn the dial to the left and right to select "Option". Then, press it again to enter the option mode.
- ▶ On the option mode, turn the jog dial to the left and right to select "Backlight", adjust the setting and press the jog dial to save the settings *choose among "Always ON/ Always OFF/ Event On for 20 seconds [Default Setting : Always ON]

Sound ON /OFF (Option function)

- ▶ Press the jog dial for 3 seconds to see the menu and turn the dial to the left and right to select "Option". Then, press it again to enter the option mode.
- ▶ On the option mode, select "Sound" by turning the jog dial to the left and right, adjust the setting and press the jog dial to save the settings [Default Setting : ON]

Return to Factory Settings (Option function)

- ▶ When users have changed the incubator settings, but want to return to factory setting.
- ▶ Press the jog dial for 3 seconds to see the menu and turn the dial to the left and right to select "Option". Then, press it again to enter the option mode.
- ▶ On the option mode, select "Reset All" by turning the jog dial to the left and right, press the jog dial to enter the factory default mode.
- ▶ When entering the factory default mode, the message "Return to Factory Setting?" comes up.
- ▶ Select YES by turning the jog dial to the left and right and press the jog dial to turn off the LCD screen along with messages and alerting sounds, going back to default in 15 seconds. Select NO and press the jog dial to go back to the previous page.

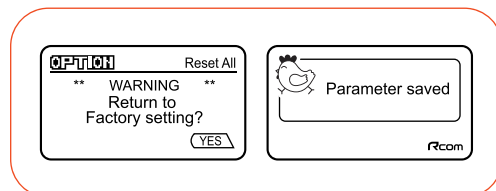
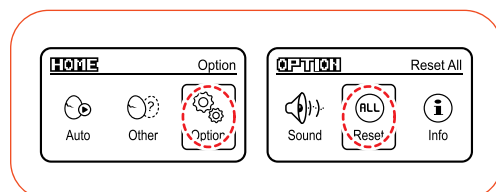

Humidity and Condensation principles, Air Flow considerations

- ▶ When hatching, humidity should be relatively high to prevent the thin membrane from drying out or hardening before hatching.
- ▶ When hatching, it's recommended not to open the door often. This is because if you open the door often humidity will be rapidly decreased and it will take a long time to regain the proper humidity.
- ⚠ **Incubator internal temperature is 37.5°C (99.5°F) or more, and hatching room temperature is below 28°C, in that case, RH 70% humidity is may not be able. The difference of ±5% humidity value may occur from the humidity sensors difference, and there are no problems at hatching.**
- ▶ It's very important to maintain humidity higher 1~2 days before hatching than the early and middle incubation periods. Humidity requirements during incubation are RH 45~55% for waterfowl, RH 40~45% for poultry and RH 35~45% for parrot, in general. One day before hatching, all kinds of birds need about RH 65% humidity and sometimes need higher than that. However, in areas of high ambient humidity, lower levels of humidity may be needed during incubation.
- ▶ Air Controlling Lever : Outer fresh air can be flowed into incubator inside without affecting insulation. When eggs start hatching, open air controlling lever either fully or half-open.
- ▶ If the temperature where incubator installed is high, it will effects to incubator' setting temperature. In this case, you are able to adjust temperature by Air ventilation on the top of machine.

You can adjust
Air Ventilation



1/4 open



1/2 open



close



wide open

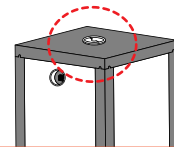

- ⚠ If you set high temperature, condensation will occur the near Air Vent and may causes licking water from the incubator and it is not a technical problem.

Post-Hatch maintenance

- ▶ Newborn birds are vulnerable to cold so it is essential to have a separate development room (brooding device) In case of developing (brooding) inside the incubator, the incubator can easily become contaminated with various bacteria which can become a major cause of reduction of hatching rate and various feather, dust, bark, manure and other pollutants can become the cause of incubator failure. In case of failure due to inappropriate usage can cause repair costs to occur even if it is within the free A/S period so purchasing of a separate development (brooding) is recommended. Instructions to build a simple development (brooding) room can be found on our homepage. (www.Rcom.co.kr → Rcom Study → Making a birdcage)

- ⚠ Do not developing chicks inside the incubator. It becomes the source of malfunction of the device and repair charges will rise even if it is within the free A/S period.



Generating Room : Space for hatching (breaking of the egg) and used 1~3 days before hatching
(Rcom maru H&B)

Development (Brooding) Room : A device designed for newly hatched chicks to adjust to the environment by maintaining proper temperature and humidity for certain amount of days.
(Rcom maru H&B / Rcom bird brooder & ICU)

- ▶ As there is some difference in chick feed for each kind of bird, so it's desirable to obtain useful information about the chicks before hatching.

Dew Condensation

Dew condensation is natural phenomenon which can be occurred when incubator inner temperature is big different from outer temperature. So, water can leak from the incubator during humidification, which is normal. Appropriate Incubator internal temperature is between 28°C (82.4°F).



Instructions for Disassembling and Cleaning

⚠ Power cord must be removed from the outlet of the machine.

- ▶ If you turn the incubator off and then leave the incubator door closed after high humidity incubation, accumulated moisture inside the incubator evaporates and sticks to electric and electronic circuits. This could cause problems, be sure to open the incubator door and completely remove moisture inside of incubator.

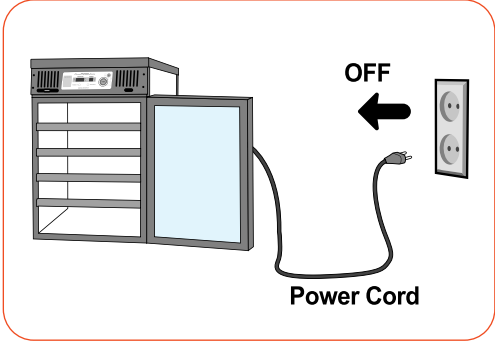

[Cleaning the Controller Unit]

- ▶ As shown in the picture, unscrew 6 screws located in the corners of the incubators cover with the screwdriver and open the cover.

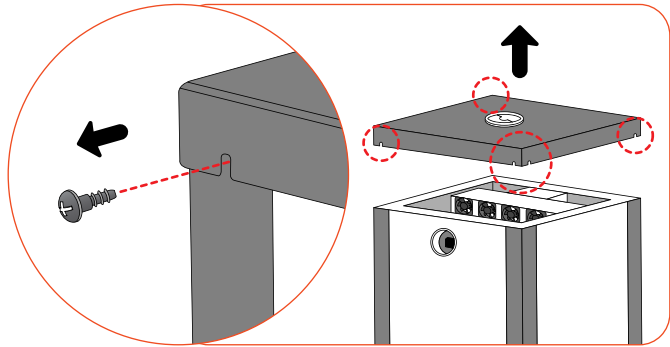

- ▶ Remove all the remaining water from the humidity unit.

Tip If a lot of dirty substance(scale) has formed in the humidifier unit, soaking it in vinegar overnight will neatly clean the humidifier unit. If a lot of scale has formed it is likely you are not using distilled water, please use distilled water as it prolongs incubator life.

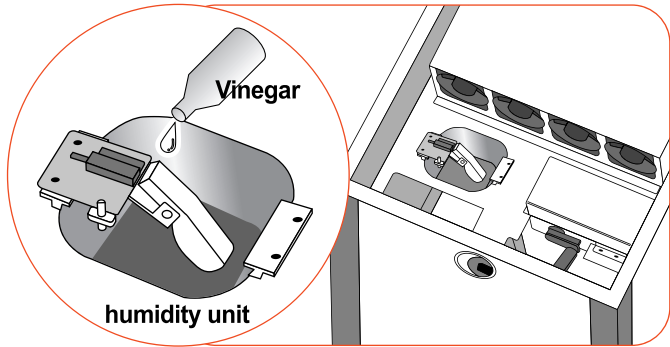

- ▶ dirty substance(scale) can form in the humidity unit and pan should be removed by using a vacuum cleaner, brush and/or further cleaning aided by vinegar.

⚠ If there are any dirty substance(scale) in the humidifier unit and pan, it must be removed.

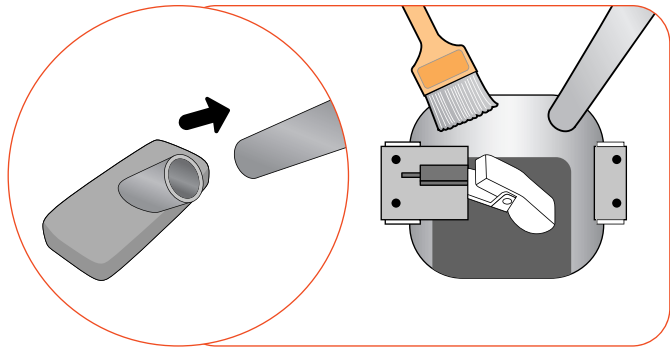

[Egg Rotator Cleaning method]

- ▶ For sliding type, after hatching, feathers and dust (dander) might be attached to the areas near carrier frame and moving turning screw, interfering with the egg turning capabilities.

⚠ After hatching, remove the contaminants using brush and drop 1~2 drops of the lubricant to the moving screw portion, as shown in the picture, will lead to smooth device operation.

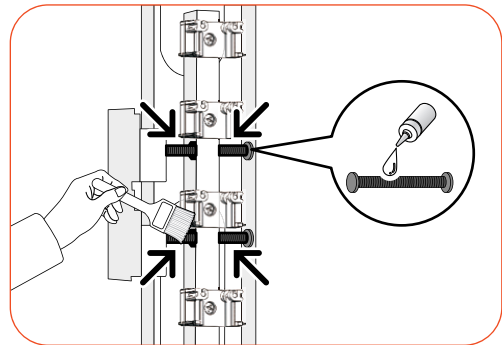

[Cleaning the Temperature, Humidity sensor]

- ▶ This sensor part lies in upper part inside the incubator, behind the controller assembly but in front of the fan/heater unit. Occasionally, fluff, feathers, dirt (Dander) or water disturbs the accurate measurement of temperature & humidity. Please clean Dander away with a soft brush.

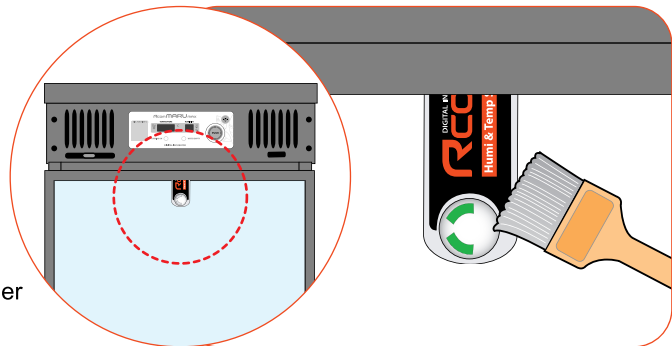

[Cleaning the Incubator Cabinet]

- ▶ After hatching, remove the universal trays and dividers from the incubator, and clean the inside with a vacuum cleaner. Brush inside the cabinet again and then vacuum again, until satisfied that the incubator is clean.

Tip After several hatching, dust or bird feathers (Dander) can build up in the mechanisms, controller and humidity unit and cause incorrect operation or malfunction. So, ensure you clean the incubator carefully after each hatch. (The life span of the humidity unit can be reduced when used without cleaning.)

⚠ Feather Dander and dust can clog up or foul circulation fans; this can make the fans noisy and also destroy the fans. It is very important to clean your incubator, for maintenance reasons and also to increase incubation success.

- ▶ Clean the universal trays, dividers with water and an anti septic solution, and then dry naturally or operate incubator temporary to dry them.

⚠ Be careful not to allow moisture into the power connecting parts on the rear of the incubator.

⚠ Do not clean the incubator with benzene or thinner. There is a risk of transformation or dis-colorization.

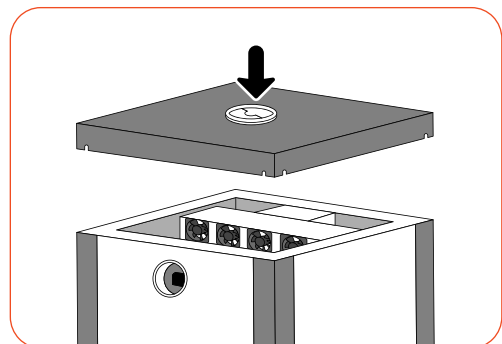

- ▶ Reassemble in the reverse order of disassembling and store machine safely in a cool dry place.

Replacing Fuse

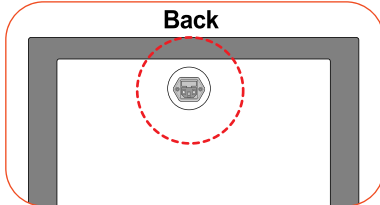

▶ Fuse is located at the top of power connection part on back side of incubator.

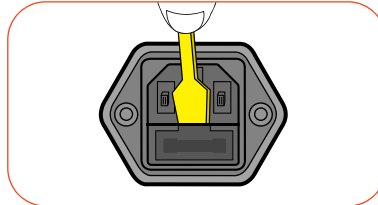

▶ When the fuse is damaged, remove the fuse at the inside below of power connection part, with screwdriver.

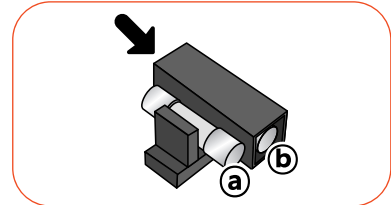

▶ Replace ①(Used Fuse) fuse with ②(Spare Fuse) fuse.
For AC 100V use :
250V 8.0A Ø5*20mm
For AC 230V use :
250V 8.0A Ø5*20mm

General maintenance

All our Rcom digital products of Autoelex Co., Ltd. are made by precision systems under strict quality control. But occasionally some defective products are found on the way of their distribution. If any problem occurs, then please contact Autoelex service center or distributors in your country. We will do our best to solve the problems, if any, for you. This product is designed in modular mode, so for its repair, if any, a qualified person can replace the part concerned with ease.

* Complaint Department : 82-55-337-2560

* E-mail Receipt : Rcom@Rcom.co.kr

Troubles	Expected Causes (Possibility)	Countermeasures
In case hatching rate is low	<ul style="list-style-type: none"> ▶ When the egg is an unfertilized egg. ▶ Getting infected by germs. ▶ Wrong incubation setting. ▶ Health condition of mother bird. ▶ Improper egg turning. 	<ul style="list-style-type: none"> ▶ Inspect the egg to check possibility of egg surviving. ▶ Disinfect the incubator. ▶ Check all settings of incubator. Especially, check them focusing on the temperature. ▶ Review care of health of mother bird. ▶ Check if egg turning is normal.
When a chick hatches out earlier than expected or a deformed chick hatches out	<ul style="list-style-type: none"> ▶ Setting temperature high. ▶ Egg turning was not operating normally. 	<ul style="list-style-type: none"> ▶ Lower temp. setting of the incubator about 0.5°C (1°F) ex) 37.5°C (99.5°F) → 37.0°C (98.6°F) ▶ Check if egg turning function is OFF.
When a chick hatches out later than expected	<ul style="list-style-type: none"> ▶ Setting temperature low. 	<ul style="list-style-type: none"> ▶ Raise temp. setting of the incubator about 0.5°C (1°F) ex) 37.0°C (98.6°F) → 37.5°C (99.5°F)
When hatching dates are so different from each egg (When all chicks don't hatch out at the same time but over a long period)	<ul style="list-style-type: none"> ▶ Eggs stored for different lengths of time. ▶ Different incubation temperatures. 	<ul style="list-style-type: none"> ▶ Minimize the time to store egg properly. ▶ Check Temperature difference in the incubator. (sunlight, temp of incubation room, etc.)
When intending to hatching various eggs at the same time	<ul style="list-style-type: none"> ▶ Incubation days are different, so hatching rate falls down. ▶ Eggs might be contaminated by chicks that hatched first. 	<ul style="list-style-type: none"> ▶ Mark hatching date on eggs and move them to other incubator(brooder) just on the marked date. ▶ In case of putting in many eggs at the same time, it's convenient to prepare a spare incubator available as a Hatcher&Brooder.

Troubleshooting(FAQ)

For more detailed self-diagnosis, see Rcom homepage "SELF DIAGNOSIS" category.

Circumstance	Items to be confirmed	Solutions
No signs of power to the incubator.	<ul style="list-style-type: none"> ▶ Check electric cord is properly connected. ▶ Check if there is a power outage. ▶ Check whether the plug is damaged. ▶ Check the fuse. 	<ul style="list-style-type: none"> ▶ Connect the cord again. ▶ Check the main socket with any other electric appliances. ▶ Try to insert to another outlet. ▶ Change the Fuse. [Refer to the page 24]
When temperature is too high / When temperature is too low	<ul style="list-style-type: none"> ▶ Check your setting temperature. ▶ Initialize the incubator. [Refer to the page 20] ▶ Please check the bottom of machine is wet or not. 	<ul style="list-style-type: none"> ▶ Set the temperature as required. ▶ Please remove moisture. ▶ Please put the water tank on the floor and use.
Alarm sounds with "HI" indication (abnormal high temp.)	<ul style="list-style-type: none"> ▶ Check if room temperature is too high. ▶ Check if incubator is exposed to the direct rays of sun. ▶ In case of lowering temperature. 	<ul style="list-style-type: none"> ▶ Adjust room temperature 28°C (82.4°F) ▶ Install incubator without the direct rays of sun. ▶ Return incubator to factory setting. [Refer to page 20]
Alarm sounds with "LO" indication (abnormal low temp.)	<ul style="list-style-type: none"> ▶ Check if room temperature is too low. (especially during night) ▶ please check the bottom of machine is wet or not. 	<ul style="list-style-type: none"> ▶ Adjust room temperature 28°C (82.4°F) ▶ Place thermometer inside of incubator and check if setting temperature is correct. ▶ Please remove moisture. ▶ Please put the water tank on the floor and use.
Humidity will not go high enough.	<ul style="list-style-type: none"> ▶ Check your setting humidity. ▶ Close the door again after checking. ▶ Initialize the incubator. [Refer to the page 20] ▶ Check if pumping is working. [Refer to the page 17] 	<ul style="list-style-type: none"> ▶ Supply water. ▶ Check if silicon tube is blocked. ▶ Set the humidity again as required. ▶ Clean the humidity unit. [Refer to page. 22~23]
The machine makes some noise. - A little noisy occurs from the inside of circulation fan.	<ul style="list-style-type: none"> ▶ Check if there is any hatching dust such as feather or eggs-shell in the incubator FAN. ▶ A little noisy is not faulty. 	<ul style="list-style-type: none"> ▶ Remove power and then open maintenance cover to clean the FAN for air circulation. [Refer to page 22~23]
Egg-Turning fails to work.	<ul style="list-style-type: none"> ▶ Check that the Egg-turning stoppage is not activated. ▶ Check that there are no foreign items on the egg turning tray. ▶ Check if egg turning plate is assembled correctly. ▶ Check to see if the egg turning for the each layer has stopped. [Refer to the page 16] ▶ Check to see if the filler bar for the slide plate is located in the middle of the carrier filler. [Refer to the page 9] 	<ul style="list-style-type: none"> ▶ If you need to turn the eggs, you can manually re-start egg-turning. ▶ Cancel the egg turning for each layer. [Refer to the page 16] ▶ Check to see if the carrier frame filler is installed. [Refer to the page 9] ▶ Lubricate the vertical gear.
Dew foams in the incubator.	<ul style="list-style-type: none"> ▶ Check the incubator is not placed too cold circumstances. ▶ When you turn OFF incubator and then turn ON. ▶ In case of setting high humidity. 	<ul style="list-style-type: none"> ▶ Adjust room temperature 28°C (82.4°F) ▶ Dew condensation is a natural phenomenon and not a malfunction of the device. [Refer to the page 21]
Water leaks from the machine.	<ul style="list-style-type: none"> ▶ Check if you did not place the water container on the incubator. ▶ Check that the incubator placed on inclined surface. ▶ Check if it is Dew condensation. ▶ When set as high humidity. ▶ When moved without taking out the water tank for the humidifier unit. ▶ When humidity unit is not cleaned. 	<ul style="list-style-type: none"> ▶ Please put the water tank on the floor and use. ▶ Place incubator under a level surface. ▶ Dew condensation is a natural phenomenon and not a malfunction of the device. ▶ Remove the remaining water in the humidity unit using pipettes or syringe. ▶ Clean the dust(scale) from the humidifier unit after use.

 Test the incubator to be sure that the incubator works without any problem before placing eggs in the incubator. Please ensure you remember how to use the machine and maybe re-read instructions.

Specification

1-1 Name : Rcom MARU DELUXE PRO 100 / 200

1-2 Model : PX-100SD / PX-200SD

NAME	ST Series Model No.	Capacities [Chick egg size]	Egg Turning Method	Egg turning angle [°]	Egg turning Interval [min]	Each-Story Egg Turning ON/OFF	Functional Ranger
100	PX-100SD	96	Slide Type	0,15°,30°, 45°... 165°, 180°,rnd	0,10,20...360	○	Temperature: 20~42°C (68~107.6°F) Humidity: 30~70%
200	PX-200SD	192	Slide Type	0,15°,30°, 45°... 165°, 180°,rnd	0,10,20...360	○	Temperature: 20~42°C (68~107.6°F) Humidity: 30~70%
NAME	ST Series Model No.	Humidification Device	The number of Trays	Dimensions (WxLxH) [mm]	Weight [Kg]	Maximum electric power [W]	Average electric power [W]
100	PX-100SD	○	2 floors	484*637*414	27	440	70
200	PX-200SD	○	4 floors	484*637*573	35.5	440	70

 We are not allowed to extend warranty therefore we ONLY provide 1 year warranty service. If you do not register, we provide limited warranty service for 1year based on factory releasedate.

 You will be asking for service charge if you are in below cases.

1. Broken or Problem caused by 'No cleaning' or 'Improper handling'
2. Broken or problem caused by 'Not using distilled water'
3. Broken or problem caused by 'Trying Bird hatching in incubator'
(Please don't try bird hatching in incubator. Please use Hatcher during bird hatching.)
4. Broken or problem caused by 'Wrong controlling(Using)'
5. Broken or Problem caused by using the machine out of User's Manual.
6. Broken or problem caused by 'Customer's mistake or fault'

※ Product Registration Procedures

If you are a new member of Rcom, you need to log in our website at www.Rcom.co.kr

1. Click "SIGN UP" on top of the right corner.
2. Fill out the information on the blanks.

If you already registered your information on the Rcom website, please log in to www.Rcom.co.kr.

1. Click "Login" on top of the right corner.
2. Select "Customer" and click "Register Products".
3. Fill out the information on the blanks.

You will need below information to register on our website.

1. Your name.
2. Your (home/company) address & Email address, country.
3. Your product(model) name & Serial number.
4. Date of purchase & Name of purchased shop you bought from.



Rcom is designed for user's easy and convenient use.
It can be changed without notice for improvement in performance,
design,treatment, and software, etc.



www.Rcom.co.kr

SELLER

MANUFACTURER

AUTOELEX CO.,LTD.

- OFFICE : 218, Sangdong-ro, Gimhae-si,
Gyeongsangnam-do, 50805 Korea
- TEL : +82-55-337-2561
- E-MAIL : sales@autoelex.com

Rcom is the Best Design with High Quality, Value, and Performance!