

Owner's Manual



➤ S941



What should you have in your carton?

1. Scooter
2. Seat
3. Headrest
4. Armrests
5. Owner's manual
6. Keys
7. Charger
8. Power cord
9. Mirror

SPECIFICATION

Model numbers	S941	
Overall Length	130 cm / 51.2"	
Overall Width	69 cm / 27.2"	
Seat Height (from deck)	43-48 cm / 17-19"	
Tires	F 12" , R 12" 4.10 / 3.50-6	
Weight Capacity	159 kg / 350 lbs	
Controller	Dynamic Rhino2-120A	
Motor	24VDC,400W	
Speed (maximum)	12kph / 7.5mph	15kph / 9.5mph
Range up to	50km / 32miles	
Turning Radius	167cm / 65.7"	
Battery Requirement	12V / 75AH x 2pcs	
Battery charger	6A-off board	
Brakes	Intelligent, regenerative, electromagnetic brakes	
Ground Clearance	9cm / 3.5"	
Battery Weight	17kg / 37lbs	
Seat Weight	18kg / 40lbs	
Gradient up to	10°	
Seat Width	47cm / 18"	
Minimum Braking Distance	290cm / 114"	
Tire Inflatium Pressure	35psi / 2.4bar	
Static stbility		
Forward	25°	
Rear	22°	
Sideways	16.1°	
Maximum height the scooter can descend	100 mm	

Contents

1. INTRODUCTION	03
2. SAFETY	04
3. YOUR SCOOTER	12
4. BATTERY AND CHARGING	16
5. OPERATION	21
6. COMFORT ADJUSTMENT	23
7. TROUBLESHOOTING	26
8. CARE AND MAINTENANCE	30
9. DISASSEMBLY AND ASSEMBLY	34
10. IEC SYMBOLS	36
11. WARRANTY	37

1. INTRODUCTION

1. INTRODUCTION

Congratulations on the purchase of your new scooter! The scooter features cutting edge technology with safety, comfort in mind. We wish to thank you for letting us improve your freedom and independence.

Intended use : for disabled person to improve their mobility ,by driving by themselves.

This model has been designed with your practical needs. It is equipped with modern high-tech electronics and special features for more comfortable ride. Its safety and performance will provide you with years of excellent service and pleasure.

We want to hear your questions, comments, and suggestions about this manual and scooter. Please feel free to contact us at the address below:

Merits Health Products CO., LTD
No. 18, Jingke Road,
T.P.M.T. Park, Nantun District,
Taichung City 40852, Taiwan, R.O.C.
TEL:886-4-23594985
FAX:886-4-23503962
www.merits.com.tw

■ Indications For Use

The Merits Transformer Power Scooter, S941, is to provide mobility to adult persons limited to a sitting position and capable to operate a few simple controls.

2. SAFETY

2. SAFETY

Read well before operation

Read and follow all instructions, warnings, and notes in this manual and all other accompanying literature before operate this product for the first time. In addition, your safety depends upon you, as well as your provider, caretaker, or healthcare professional in using good judgement.

If there is any information in this manual which you don't understand, or if you require additional assistance for setup or operation, please contact your dealer. Failure to follow the instructions, warnings, and notes in this manual and those located on your product can result in personal injury or product damage and will void our product warranty.

Modification



WARNING

Do not modify your scooter or change the programmed parameters of your scooter controller in any way. Do not use any accessories if they have not been tested or approved. These may result in personal injury and damage the scooter. Only from the manufacturer authorized personnel may perform any adjustments for you.

Pre-ride safety check

Get to know the feel of your scooter and its capabilities. We recommend that you perform a safety check before each use to make sure your scooter operates smoothly and safely.

Find an open area such as a park and have an assistant to help you practice until you have confidence operating the vehicle.

- Check for proper tire inflation.
- Make sure all electrical connections are tight and not corroded.
- Check the brakes.
- Check the battery charge.

2. SAFETY

Tire inflation

Your scooter is equipped with pneumatic tires, you should have the air pressure checked at least once a week. Proper inflation pressures will prolong the life of your tires and help ensure the smooth operation of your scooter.

WARNING

Do not underinflate or overinflate your tires. Low pressure may result in loss of control, and overinflate may burst. It is very important that 35psi (2.4 bar) tire pressure be maintained in pneumatic tires at all times.

Weight limitations

Stay within the specified weight capacity for your scooter. Exceeding the weight capacity voids your warranty. We will not be held responsible for injuries or property damage resulting from failure to observe weight limitations.

WARNING

Do not carry passengers on your scooter. Carrying passengers on your scooter may affect the center of gravity, resulting in a tip or a fall.

2. SAFETY

Incline information

Now buildings have ramps with specified degree of inclination, designed for easy and safe access. Pay attention when driving down a incline and keep the scooter's speed adjustment set to the slowest speed setting to ensure a safely controlled descent. Avoid sudden stops and starts on the ramps.

! WARNING

- When climbing an incline, try to keep your scooter moving. If you must stop, start up again slowly and accelerate cautiously. When driving down an incline, set your scooter the slowest setting and drive in the forward direction only.
- Do not zigzag or drive at an angle up the face of the incline. Drive your scooter straight up the incline. This greatly reduces the possibility of a tip or a fall. Always exercise extreme caution when negotiating an incline.
- You should not travel up or down a potentially hazardous inline, such as area covered with snow, ice, cut grass, or wet leaves.
- When on any sort of incline or decline, never place the scooter in "Free wheel" mode while seated on it or standing next to it. It may result in personal injury and damage to your scooter. Never travel down an incline backwards, it may result in personal injury.

(Picture 2.1 with driving position- Increased stability driving position)

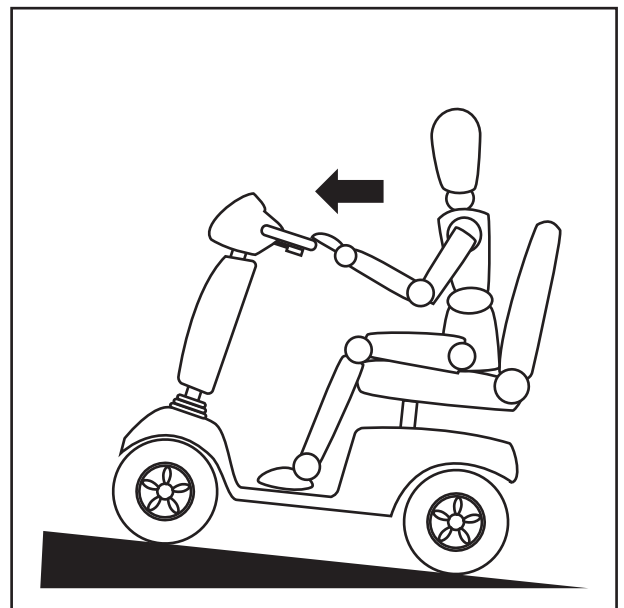

Picture 2.1 Incline information

2. SAFETY

Braking information

Your scooter is equipped with these powerful braking systems:

Electromagnetic regenerative brake: Uses electricity to rapidly slow the vehicle when the throttle control lever returns to the center/stop position and act as a parking brake.

Manual brake : Activates mechanically when power is removed from the system for any reason. The manual brake is not a parking brake. It can be used as a running brake in freewheel mode.

In freewheel mode an assistant has to operate the parking brake by engaging the drive system again. No battery power is necessary for this function.

Outdoor driving surface

Avoid driving on uneven terrain or soft surface.

Avoid tall grass that can become tangled in the running gear.

Avoid loosely packed gravel and sand.

If you feel unsure about a driving surface, avoid the surface.

Obstacles (steps, curbs, etc)

Do not attempt to have your scooter proceed backward down any step, curb, or other obstacle. This may cause the scooter to tip. We recommend that you do not attempt to negotiate a curb that has a height greater than 4in. (10cm). Doing so could cause instability in your scooter.



Picture 2.2 Obstacles information

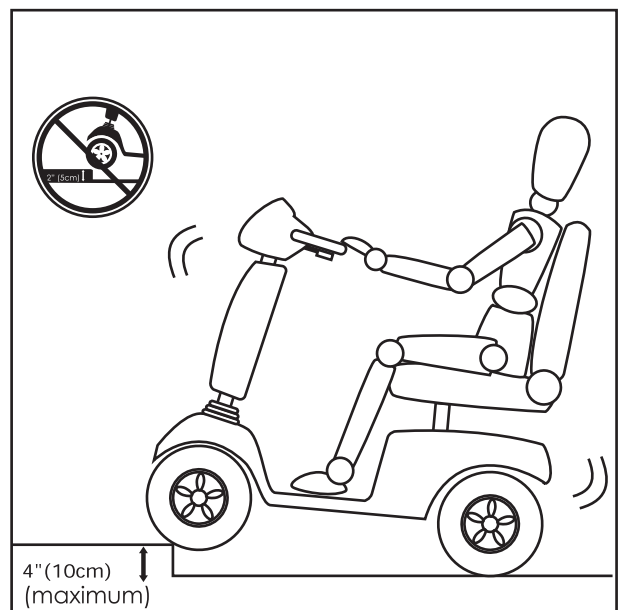

Picture 2.3 Obstacles information

2. SAFETY

Inclement weather precautions

Exposure of your scooter to inclement weather conditions should be avoided whenever possible. If suddenly caught up in rain, snow, severe cold or heat while operating your scooter, proceed to shelter at the earliest opportunity. Thoroughly dry your scooter before storing, charging, or operating your scooter.

Freewheel mode

When your scooter is in freewheel mode, the braking system is disengaged. Disengage the drive motors only on a level surface. Stand to the side of the scooter to engage or disengage freewheel mode. Do not sit on a scooter to do this. The freewheel mode is only to use with an assistant, who is able to engage again in a hazardous situation.

Stairs and elevators

Electric scooter is not designed to travel down or up stairs or escalators. Always use an elevator. Drive your scooter gently and slowly forward to push the door open. Or drive your scooter gently and slowly rearwards to pull the door open.

Batteries

Scooter batteries are heavy, if you are unable to lift it, be sure to get help. Always protect the batteries from freezing. Charging a frozen battery may result in damage to the battery. Connect the battery harnesses in the proper manner.

2. SAFETY

Transport

Do not remain seated in your scooter while traveling in a motor vehicle. The scooter should be stowed in the trunk of a car with batteries removed and properly secured. All scooter parts should be removed and properly secured during motor vehicle transport.

Getting onto and off scooter

Getting onto and off of your scooter requires a good sense of balance. Please following the safety tips when getting onto and off of your scooter :

- Remove the key from the key switch.
- Ensure that your scooter is not in freewheel mode.
- Make certain that the seat is fixed into place.



WARNING

Avoid putting all your weight on the scooter armrests and do not use the armrests for weight bearing purposes, such as transfers. It may cause the scooter to tip, resulting in a fall from the scooter.

Positioning belts

Other healthcare professionals and we are responsible for the mounting of a positioning belt in order to operate your scooter safely. Make sure it is fastened securely in order to reduce the possibility of a fall from the scooter.

Alcohol

Do not operate your scooter while you are under the influence of alcohol, as this may impair your ability to drive safely.

Pre-sale information

What people can not use this scooter: mentally handicapped people, persons with insufficient eyesight, one-hand people, children under 6 years, drunken people.

2. SAFETY

Electromagnetic interference

This vehicle has an immunity level of 20 V/m which should protect it from Electromagnetic Interference (EMI) from Radio Wave Sources. The rapid development of electronics, especially in the area of communications, has saturated our environment with electromagnetic (radio) waves that are emitted by television, radio and communication signals. These EM waves are invisible and their strength increases as one approach the source. All electrical conductors act as antennas to the EM signals and, to varying degrees, all power wheelchairs and scooters are susceptible to electromagnetic interference (EMI). This interference could result in abnormal, unintentional movement and/or erratic control of the vehicle. The United Statement is incorporated to the user's manual for all electric scooters.

Powered wheelchairs and electric scooters (in this text, both will be referred to as powered wheelchairs) may be susceptible to electromagnetic interference (EMI), which is interfering electromagnetic energy emitted from sources such as radio stations, TV stations, amateur radio (HAM) transmitters, two-way radios and cellular phones. The interference (from radio wave sources) can cause the powered wheelchair to release its brakes, move by itself or move in unintended directions. It can also permanently damage the powered wheelchair's control system. The intensity of the EM energy can be measured in volts per meter (V/m). Each powered wheelchair can resist EMI up to certain intensity. This is called the "immunity level." The higher the immunity level the greater the protection. At this time, current technology is capable of providing at least 20 V/m of immunity level which would provide useful protection against common sources of radiated EMI.

2. SAFETY

Following the warnings listed below should reduce the chance of unintended brake release or powered wheelchair movement that could result in serious injury:

- Do not turn on hand-held personal communication devices such as citizens band (CB) radios and cellular phones while the powered wheelchair is turned on.
- Be aware of nearby transmitters such as radio or TV stations and try to avoid coming close to them.
- If unintended movement or brake release occurs, turn the powered wheelchair off as soon as it is safe.
- Be aware that adding accessories or components, or modifying the powered wheelchair, may make it more susceptible to interference from radio wave sources. (Note: there is no easy way to evaluate their effect on the overall immunity of the powered wheelchair).

The FDA has written to the manufacturers of power wheelchairs, asking them to test their new products to be sure they provide a reasonable degree of immunity against EMI. The letter says that powered wheelchair should have an immunity level of at least 20 V/m, which provide a reasonable degree of protection against the more common sources of EMI. The higher the level the greater the protection.

- Report all incidents of unintended movement or brake release to the powered wheelchair manufacturer, and note whether there is a radio wave source nearby.



WARNING

The scooter might disturb the operation of devices in its environment that emit electromagnetic fields (e.g. alarm systems of shops, automatic doors etc.)

3. YOUR SCOOTER

3. YOUR SCOOTER

Controls (Digital dashboard)

The tiller includes the speed adjustment knob, throttle control lever, LCD display, half speed button, hazard light button, headlight button, turn signal buttons, and horn button.



WARNING

User can not modify the controller parameters, it may result in personal injury and damage to your scooter.

Speed Adjustment Knob

This dial allows you to preselect and limit your scooter's top speed. The image of the turtle represents the slowest speed setting. The image of the hare represents the fastest speed setting.

Throttle Control Lever

This lever allows you to control the forward speed and the reverse speed of your scooter up to the maximum speed you preset with the speed adjustment dial.

To Move Forward use either of the following:

- Use your left thumb to push the left side of the throttle control lever.
- Use your right hand fingers to pull back on the right side of the throttle control lever.

To Move Rearward use either of the following:

- Use your right thumb to push the right side of the throttle control lever.
- Use your left hand fingers to pull back on the left side of the throttle control lever.

Release the throttle control lever and allow your scooter to come to a complete stop before engaging the other side of the lever. When the throttle control lever is completely released, it automatically returns to the center "stop" position and engages your scooter's brakes.

Hazard Light Button

The hazard light is activated by pressing the hazard light button. The hazard light of the indicator light area will light up when pressing the button. Pressing the button a second time will turn it off.

3. YOUR SCOOTER

Turn Signals

Left turn signals button: Pressing the button will activate the left turn signal lights. The turn signals of the indicator light area will light up when pressing the button. Pressing a second time will turn it off.

Right turn signals button: Pressing the button will activate the right turn signal lights. The turn signals of the indicator light area will light up when pressing the button. Pressing a second time will turn it off.

Battery Condition Meter

When the key is fully inserted and turned clockwise to power up your scooter, LCD shows battery voltage condition. If the battery voltage is low, the batteries need to be charged as soon as possible. If the battery voltage is high, the batteries are fully charged.

Headlight Button

The headlight is activated by pressing the headlight button. The headlight of the indicator light area will light up when pressing the button. Pressing the button a second time will turn it off.

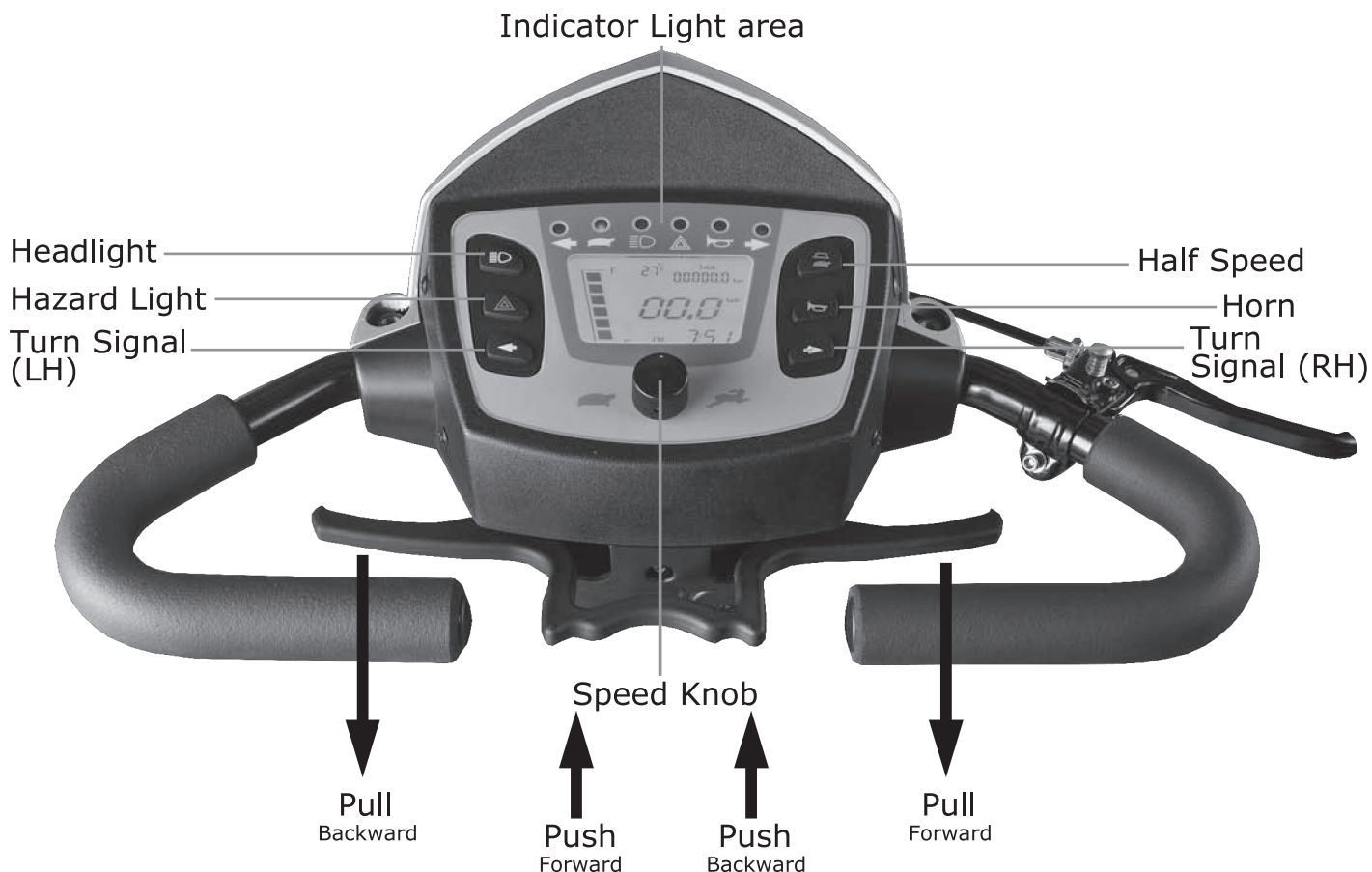

3. YOUR SCOOTER

Horn Button

The button activates a warning horn. The horn of the indicator light area will light up when pressing the button. Using the warning horn when doing so may prevent accident or injury.

Key Switch

Insert the key into the key switch and turn it clockwise to turn on your scooter. Turn the key counterclockwise to turn off your scooter.

LCD Display

The Display shows the battery condition, Speedometer, odometer, temperature and maintenance messages.

- Battery condition: Be aware when the battery becomes depleted. Estimate the distance and expected time for your trip before you start. We recommend you charge the battery after finished using you scooter. (See 4. Battery and charging)
- Meter (Speedometer, odometer) : The LCD display shows current speed and total range.
- Temperature: You will know the temperature degree on the LCD display.
- Diagnostic fault code: It shows the status of your scooter, when you see the wrench icon flashing with the code number on LCD display.

- 1- Battery needs recharging.
- 2- Battery voltage too low
- 3- Battery voltage too high
- 4- Current time limit out
- 5- Brake fault
- 6- Not in neutral at power up
- 7- Speed pot error
- 8- Motor volts error
- 9- Other internal error
- 10- Push too fast fault

3. YOUR SCOOTER

Motor/Transaxle Assembly

The motor/transaxle assembly is an electromechanical unit that converts electrical energy from your scooter's batteries into the controlled mechanical energy that drives the scooter's wheels.



WARNING

Surface temperatures can increase when exposed to external sources of heat (e.g. sunlight)

Manual freewheel lever

Whenever you need or want to push your scooter for short distances, you can put it in freewheel mode.

1. Remove the key from the key switch.
2. Push the manual freewheel lever to disable the drive system and the brake system. You may now push your scooter.
3. Pull back on the manual freewheel lever to reengage the drive and the brake systems and take your scooter out of freewheel mode.

When your scooter is in freewheel mode, the braking system is disengaged.

Disengage the drive motors only on a level surface.

Ensure the key is removed from the key switch.

Stand to the side of the scooter to engage or disengage freewheel mode. Never sit on a scooter to do this.

After you have finished pushing your scooter, always return it to the drive mode to lock the brakes.

Seat

The level of resistance to ignition of materials and assemblies : Materials are tested according to EN1021-1, -2(seat, armrests).

4. BATTERY AND CHARGING

4. BATTERY AND CHARGING

Batteries and charging

Your scooter is equipped with maintenance free, sealed lead acid batteries. The batteries require no maintenance other than ensuring that they are properly charged. If other batteries are used, check with your battery supplier for proper battery care and maintenance instruction.

Your scooter comes supplied with two batteries. Attach the red wire of the breaker cable to the (+) terminal of the first battery. Attach the black wire of the breaker cable to the (-) terminal of the second battery. Repeat this procedure for the controller power cable.



WARNING

Charge your scooter's batteries fully prior to using it for the first time. Keep the batteries fully charged to keep your scooter running smoothly.

Using off-board charger

Follow the steps to charge your batteries:

1. Position your scooter close to a standard electrical outlet.
2. Remove the key from the key switch.
3. Make certain that the manual freewheel lever is in the drive position.
4. Plug the 3-pin charger power cord into the off-board charger port.
5. Extend the charger power cord and plug it into the electrical outlet. We recommend that you charge the batteries for 8 to 14 hours. (Check the progress lights on the charge unit).
6. When the batteries are fully charged, unplug the charger power cord from the electrical outlet and then from the off-board charger port.

4. BATTERY AND CHARGING

!! PROHIBITED !!

- Never use an extension cord to plug in your battery charger. Plug the charger directly into a properly wired standard electrical outlet.
- Removal of the grounding prong can create an electrical hazard. If necessary, properly install an approved 3-pronged adapter to an electrical outlet having 2-pronged plug access.
- Do not allow unsupervised children to play near the scooter while the batteries are charging. We recommend that you do not charge the batteries while the scooter is occupied.

!! MANDATORY !!

Read the battery charging instructions in this manual and in the manual supplied with the battery charger before charging the batteries.



WARNING

- Inspect the battery charger, wiring, and connectors for damage before each use.
- Do not attempt to open the battery charger case. If the off-board battery charger is equipped with cooling slots, then do not attempt to insert objects through these slots.
- Use only the original battery charger, which was accompanied with your scooter.

4. BATTERY AND CHARGING

Frequently asked questions

How does the charger work?

When your scooter's battery voltage is low, the charger works harder, sending more electrical current to the batteries to bring up their charge. As the batteries approach a full charge, the charger sends less and less electrical current. When the batteries are fully charged, the current sent from the charger is at nearly zero amperage. Therefore, when the charger is plugged in, it maintains the charge on your scooter's batteries, but does not overcharge them. We do not recommend that you charge your scooter's batteries for more than 24 consecutive hours.

Can I use a different charger?

Chargers are selected precisely for particular applications and are especially matched to the type, size, and chemical formulation of specific batteries. Any charging method resulting in batteries being charged individually is especially prohibited.

What if my scooter's batteries won't charge?

- Ensure the red (+) and black (-) battery cables are connected properly to the battery terminals.
- Ensure battery harnesses that extend from the batteries are plugged/ connected into their mating connector/ terminals.
- Ensure both ends of the charger power cord are inserted fully.

4. BATTERY AND CHARGING

How often must I charge the batteries?

When you decided to all day use your scooter on a basis or infrequent sporadic scooter use, with these considerations in mind, you can determine how often and for how long you should charge your scooter's batteries. We designed the off-board charger so that it will not overcharge your scooter's batteries. However, you may encounter some problems if you do not charge your batteries often enough and if you do not charge them on a regular basis. Following the guidelines below will provide safe and reliable battery operation and charging.

- If you use your scooter daily, charge its batteries as soon as you finish using it for the day. We recommend that you charge your scooter's batteries for 8 to 14 hours after daily use.
- If you use your scooter once a week or less, charge its batteries at least once a week for 12 to 14 hours at a time.
- Keep your scooter's batteries fully charged.
- Avoid deeply discharging your scooter's batteries.

How can I ensure maximum battery life?

Fully charged deep-cycle batteries provide reliable performance and extended battery life. Keep your scooter's batteries fully charged whenever possible. Protect your scooter and batteries from extreme heat or cold. Batteries that are regularly and deeply discharged, infrequently charged, stored in extreme temperatures, or stored without a full charge may be permanently damaged, causing unreliable performance and limited service life.

4. BATTERY AND CHARGING

How can I get maximum range or distance per charge?

Rarely will you have ideal driving conditions—smooth, flat, hard driving surfaces with no wind or curves. Often, you will face hills, pavement cracks, uneven and loosely packed surfaces, curves, and wind, all of which affect the distance or running time per battery charge. Below are a few suggestions for obtaining the maximum range per battery charge.

- Always fully charge your scooter's batteries prior to daily use.
- Maintain but do not exceed the psi/bar/kPa air pressure rating indicated on pneumatic tires.
- Plan your route ahead to avoid as many hills, cracked, broken or soft surfaces as possible.
- Limit your baggage weight to essential items.
- Try to maintain an even speed while your scooter is in motion.
- Avoid stop-and-go driving.

What type and size of battery should I use?

We recommend deep-cycle batteries that are sealed and maintenance free.

How do I change a battery in my scooter?

Battery posts, terminals, and related accessories contain lead and lead compounds. Wear goggles and gloves when handling batteries and wash hands after handling.

- Always use two batteries of the exact same type, chemistry, and amp-hour (Ah) capacity. Refer to the specifications table in this manual and in the manual supplied with the battery charger for recommended type and capacities.
- Contact your dealer if you have any questions regarding the batteries in your scooter.
- Do not replace the batteries while the scooter is occupied.
- Do not mix old and new batteries. Always replace both batteries at the same time.

5. OPERATION

5. OPERATION

Getting onto your scooter

1. Make certain that the key is removed from the key switch.

Never attempt to get onto or off of your scooter without first removing the key from the key switch. This will prevent the scooter from moving if accidental throttle control lever contact is made.

2. Stand at the side of your scooter.

3. Disengage the seat rotation lever and rotate the seat until it is facing you.

4. Make certain that the seat is fixed securely in position.

5. Position yourself comfortably and securely in the seat.

6. Disengage the seat rotation lever and rotate the seat until you are facing forward.

7. Make certain that your feet are safely on the floorboard.

Operating your scooter

Keep both hands on the tiller and your feet on the floorboard at all times while operating your scooter. This driving position gives you the most control over your vehicle.

- Set the speed adjustment dial to your desired speed.
- Push or pull the appropriate side of the throttle control lever.
- The electromechanical disc park brake automatically disengages and the scooter accelerates smoothly to the speed you preselected with the speed adjustment dial.
- Pull on the left handgrip to steer your scooter to the left.
- Pull on the right handgrip to steer your scooter to the right.
- Move the tiller to the center position to drive straight ahead.
- To stop, slowly release the throttle control lever. The electronic brakes will automatically engage, bringing your scooter to a stop.

WARNING

The following can adversely affect steering and stability while operating your scooter, resulting in loss of control or tipping:

- Holding onto or attaching a leash to walk your pet.
- Carrying passengers (including pets).
- Hanging any article from the tiller.
- Towing or being pushed by another motorized vehicle.

5. OPERATION

Getting off your scooter

1. Bring your scooter to a complete stop.
2. Remove the key from the key switch.
3. Disengage the seat rotation lever and rotate the seat until you are facing toward the side of your scooter.
4. Make certain that the seat is fixed securely in position.
5. Carefully and safely get out of the seat and stand to the side of your scooter.
6. You can leave the seat facing to the side to facilitate boarding your scooter next time.

Power down timer feature

Your scooter is equipped with an energy saving automatic power down timer feature designed to preserve your scooter's battery life. If you mistakenly leave the key in the key switch and in the "on" position but do not use your scooter for approximately 10 minutes, the scooter's controller shuts down automatically. Although the controller is shut down, power will still be supplied to the scooter's lighting system.

If the power down timer feature takes effect, perform the following steps to resume normal operation:

1. Remove the key from the key switch.
2. Reinsert the key and power up your scooter.

6. COMFORTABLE ADJUSTMENTS

6. COMFORTABLE ADJUSTMENTS

! WARNING

Warning: Be careful when you perform any adjustments to avoid any injury by squeezing your fingers. For removing the seat two persons should grip the seat.

Tiller angle adjustment

The tiller angle adjustment allows you to position the dash closer or further away from you for better access to the controls (See Picture 6.1).

1. Locate the angle adjusting lever where is located on the inside center of the tiller boot.
2. Hold the weight of the tiller with on hand and loosen the lever by pulling up the lever with the other hand. Pushing down will release the tiller locking mechanism, allowing you to move the tiller freely.
3. Release the lever and try to move the tiller back an forth slightly allowing the lever to lock.

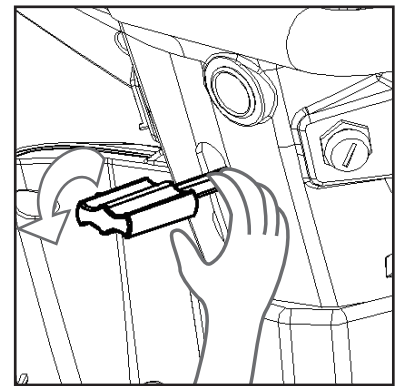

Picture 6.1

Seat rotation adjustment

The seat rotation lever will secure the seat into several positions. (See Picture 6.2)

1. Push the seat rotation lever to disengage the seat.
2. Rotate the seat to the desired position.
3. Release the lever to secure the seat into place.

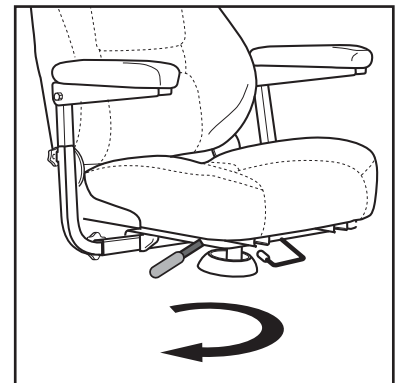

Picture 6.2

Back rest angle

Fold the backrest for easy access.
(See Picture 6.3)

Front-to-back seat adjustment

You can reposition the seat forward or rearward to adjust the distance between the seat and the tiller.

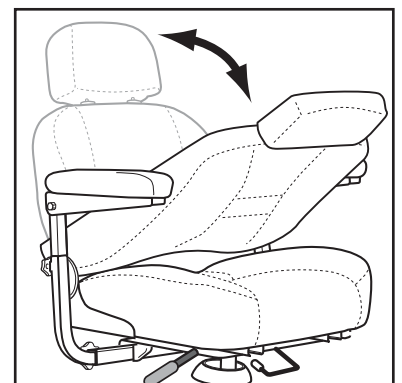

Picture 6.3

6. COMFORTABLE ADJUSTMENTS

Armrest width adjustment

The armrest width can be adjusted inward or outward.
(See Picture 6.4)

1. Loosen the armrest adjustment knobs.
 2. Slide the armrests in or out to the desired width.
 3. Align the adjustment holes on the seat frame and armrest.
 4. Tighten the armrest adjustment knobs as required.
- NOTE: Pivot the armrests upward to aid in getting onto and off of your scooter.

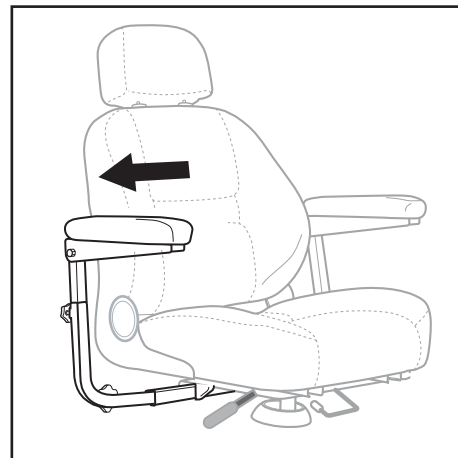

Picture 6.4

Armrest height adjustment

Loosen the clamping nut at the rear of the handle.
Turn the bolt into the lower the angle of the armrest to desired angle. (See Picture 6.5)

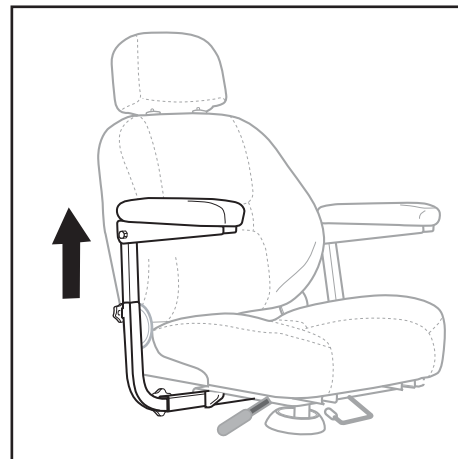

Picture 6.5

Seat height adjustment

The seat can be repositioned to different heights.

1. Remove the seat and rear shroud from your scooter.
2. Loosen the seat height adjustment nut and remove it from the bolt. Remove the bolt.
3. Raise or lower the upper seat post to the desired seat height.
4. While holding the upper seat post at that height, match up the locating holes in the upper seat post with those of the lower seat post.
5. Insert the seat height adjustment bolt through the locating holes of both the upper and lower seat posts.
7. Install the nut onto the bolt and tighten.
8. Reinstall the rear shroud and the seat.

6. COMFORTABLE ADJUSTMENTS

Mirror position

To install the mirror:

1. Insert the threaded end of the mirror holder into the opening and rotate it clockwise until snug.
2. If necessary, rotate the nut clockwise to secure the mirror in place.

To adjust the mirror:

1. Position yourself in a seated driving position facing forward.
2. Adjust the mirror left, right, up, or down until you have a good line of sight behind you.

7. TROUBLESHOOTING

7. TROUBLESHOOTING

Any electromechanical device occasionally requires some troubleshooting. However, most of the problems that may arise can usually be solved with a bit of thought and common sense. Many of these problems occur because the batteries are not fully charged or because the batteries are worn down and can no longer hold a charge.

DIAGNOSTIC FAULT CODES

The diagnostic fault codes for your scooter are designed to help you perform basic troubleshooting quickly and easily. The scooter will display a diagnostic fault code in the event one of the conditions listed below develops.

- 1- Battery needs recharging.
- 2- Battery voltage too low
- 3- Battery voltage too high
- 4- Current time limit out
- 5- Brake fault
- 6- Throttle not in neutral at power up
- 7- Speed potentiometer error
- 8- Motor error
- 9- Other internal error
- 10- Push too fast fault

What if all the systems on my scooter seem to be "dead"?

- Make certain that the key is in the "on" position.
- Check that the batteries are fully charged.
- Push in the main circuit breaker reset button.
- Make certain that battery harnesses and the front-to-rear harness are firmly connected.
- Be sure the power down timer feature has not been activated.

7. TROUBLESHOOTING

What if my scooter does not move when I engage the throttle control lever?

- When the manual freewheel lever is pushed forward, the brakes are disengaged and all power to the motor/transaxle assembly is cut.
- Push rearward on the manual freewheel lever, turn the scooter off and then turn the scooter on to return to normal scooter operation.

What if the main circuit breaker repeatedly trips?

- Charge the scooter's batteries more frequently.
- If the problem continues, have both of your scooter's batteries load tested by your authorized dealer.
- If the main circuit breaker trips repeatedly, contact your authorized dealer for service.
- You may also perform the load test yourself. Battery load testers are available at most automotive parts stores.
- Follow the directions supplied with the load tester.

7. TROUBLESHOOTING

What if the battery condition dips way down and the motor surges or hesitates when I engage the throttle control lever?

- Fully charge your scooter's batteries.
- Have your authorized dealer load test each battery.
- See the previous troubleshooting question for load testing the batteries yourself.

If you experience any problems with your scooter that you are not able to solve, immediately contact your authorized dealer for information, maintenance, and service.

What about public transportation?

If you intend to use public transportation with your scooter, you must contact the transportation provider in advance to determine their specific requirements.

8. CARE AND MAINTENANCE

8. CARE AND MAINTENANCE

Your scooter requires a minimal amount of care and maintenance. If you do not feel confident in your ability to perform the maintenance listed below, you may schedule inspection and maintenance at your authorized. The following areas require periodic inspection and/or care and maintenance.

Tire pressure

- If equipped with pneumatic tires, always maintain the psi/bar/kPa air pressure indicated on each tire.
- It is important that the psi/bar/kPa air pressure indicated on each tire be maintained in pneumatic tires at all times. Do not underinflate or overinflate your tires.
- Low pressure may result in loss of control, and overinflated tires may burst. Failure to maintain the psi/bar/kPa air pressure indicated on pneumatic tires at all times may result in tire and/or wheel failure.
- Regularly inspect your scooter's tires for signs of wear.

Exterior surfaces

Bumpers, tires, and trim can benefit from an occasional application of rubber or vinyl conditioner.

Do not use a rubber or vinyl conditioner on the scooter's vinyl seat or tire tread, as this may cause them to become dangerously slippery.

8. CARE AND MAINTENANCE

Cleaning and disinfection

- Use a damp cloth and mild, non-abrasive cleanser to clean the plastic and metal parts of your scooter.

Avoid using products that may scratch the surface of your scooter.

- If necessary, clean your product with an approved disinfectant. Make sure the disinfectant is safe for use on your product before application.

- Follow all safety instructions for the proper use of the disinfectant and cleaning agent before applying it to your product. Failure to comply may result in skin irritation or premature deterioration of upholstery and/or scooter finishes.

Battery terminal connections

- Make certain that the terminal connections remain tight and uncorroded.

- The batteries must sit flat in the battery wells.

ABS plastic shrouds

- The front tiller shroud, front shroud, and the rear shroud are formed from durable ABS plastic and are coated with an advanced formula urethane paint.

- A light application of car wax will help the shrouds retain their high gloss.

Motor brushes

The motor brushes are housed inside of the motor transaxle/assembly. They should be inspected periodically for wear by your authorized dealer.

AXLE BEARINGS AND THE MOTOR/TRANSAXLE ASSEMBLY

You do not need to lubricate these items, as they are all prelubricated and sealed.

8. CARE AND MAINTENANCE

Wheel replacement

If your scooter is equipped with pneumatic tires and you have a flat tire, you can have the tube replaced.

If your scooter is equipped with a solid tire insert, either the solid insert or the entire wheel must be replaced depending on the model. Contact your dealer for information regarding replacement wheels for your scooter.

Be sure that the key is removed from the key switch and the scooter is not in freewheel mode before performing this procedure.

Follow these easy steps for a quick and safe repair for solid tires:

1. Remove the key from the key switch.
2. Elevate the side of the scooter of which you are removing the tire. Place wooden blocks under the frame to elevate the scooter.
3. Remove the drive wheel nut and washer from the axle.
4. Pull the wheel off the axle.
5. Slide the new wheel back onto the axle. Make sure that the axle key is in the axle slot.

Failure to ensure that the axle key is properly installed into the axle slot when mounting the wheel can result in electronic brake failure, personal injury, and product damage.

6. Reinstall the drive wheel nut and washer onto the axle and tighten. Make sure both the nut and washer are reinstalled and tightened properly.
7. Remove the block from beneath the scooter.

8. CARE AND MAINTENANCE

Wiring harnesses

- Regularly check all wiring connections.
- Regularly check all wiring insulation, including the charger power cord, for wear or damage.
- Have your authorized dealer repair or replace any damaged connector, connection, or insulation that you find before using your scooter again.
- Even though the scooter has passed the necessary testing requirements for ingress of liquids, you should keep electrical connections away from sources of dampness, including direct exposure to water or bodily fluids and incontinence. Check electrical components frequently for signs of corrosion and replace as necessary.

Nylon lock nut replacement

Any nylon insert lock nut removed during the periodic maintenance, assembly, or disassembly of the scooter must be replaced with a new nut. Nylon insert lock nuts should not be reused as it may cause damage to the nylon insert, resulting in a less secure fit. Replacement nylon insert lock nuts are available at local hardware stores or through your dealer.

LCD Setting procedure

- A. Key switch off.
- B. Keep pressing both head light button and half speed button for 3 seconds and key switch on
- C. Release both head light button and half speed button, the display is now in setting mode.
- D. Press hazard light button once at a time to choose the item you want to set. (The items are AM/PM, hour, minute, °C/°F, km/mile and kph/mph.)
- E. Press left indicator button or right indicator button to change the setting.
- F. Leave all buttons for more than 5 seconds, the display will automatically go back to drive mode and store the settings.

8. CARE AND MAINTENANCE

Console, charger, and electronic controller module

- Keep these areas away from moisture.
- Before operating your scooter, allow any of these areas to dry thoroughly if they have been exposed to moisture.

Fuses

To replace a fuse:

1. Remove the fuse by pulling it straight out of its slot.
2. Examine the fuse to be sure it is blown.
3. Insert a new fuse of the proper rating.

Storing your scooter

If you plan on not using your scooter for an extended period of time, it is best to:

1. Fully charge its batteries prior to storage.
2. Disconnect the batteries from the scooter.
3. Store your scooter in a warm, dry environment.
4. Avoid storing your scooter where it will be exposed to temperature extremes.

Always protect batteries from freezing temperatures and never charge a frozen battery. Charging a frozen battery can result in damage to the battery.

Recycle

Information on the recycling of used batteries and other parts of the scooter; use only special recycling for the scooter parts, no general disposal (e.g. batteries, electronics)

9. DISASSEMBLY AND ASSEMBLY

9. DISASSEMBLY AND ASSEMBLY

You can disassemble the scooter into four components: the main frame, battery shroud, batteries, seat.

No tools are required to disassemble or assemble your scooter, but keep in mind that the disassembled sections of the scooter take up more floor space than the assembled unit. Always disassemble or assemble your scooter on a level, dry surface with sufficient room for you to work and move around your scooter. Remember that some components are heavy and you may need assistance when lifting them.

! WARNING

Do not lift beyond your physical capability. Ask for assistance when necessary while disassembling and assembling your scooter.

Seat

To remove the scooter seat, see "Comfort Adjustments."

Rear Shroud

To remove the battery shroud:

1. Remove the seat from your scooter.
2. Lift the shroud up and over the seat post. (See Picture 9.1)

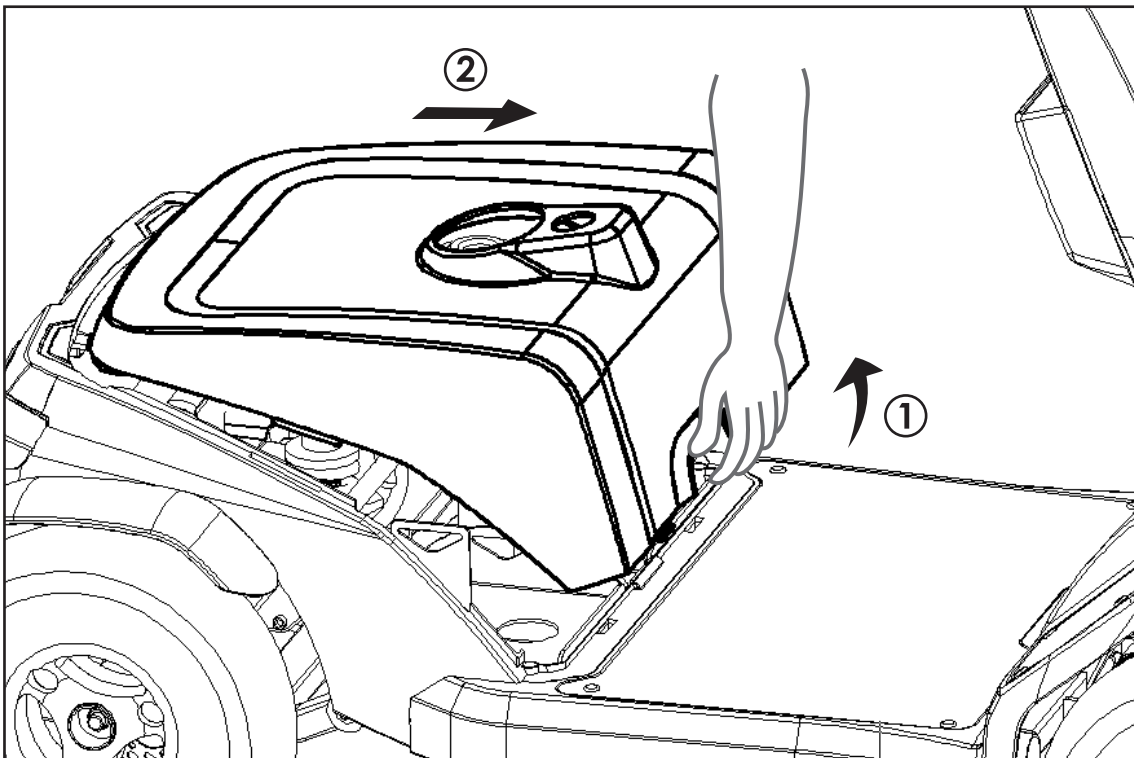

9. DISASSEMBLY AND ASSEMBLY

■ Disassembly of the scooter

This scooter can be separated into four parts, the main frame, battery shroud, seat, and the battery. Follow the procedures below to disassemble your scooter and transport it with care.

Scooter can be folded or dismantled to assist in storage or transport.



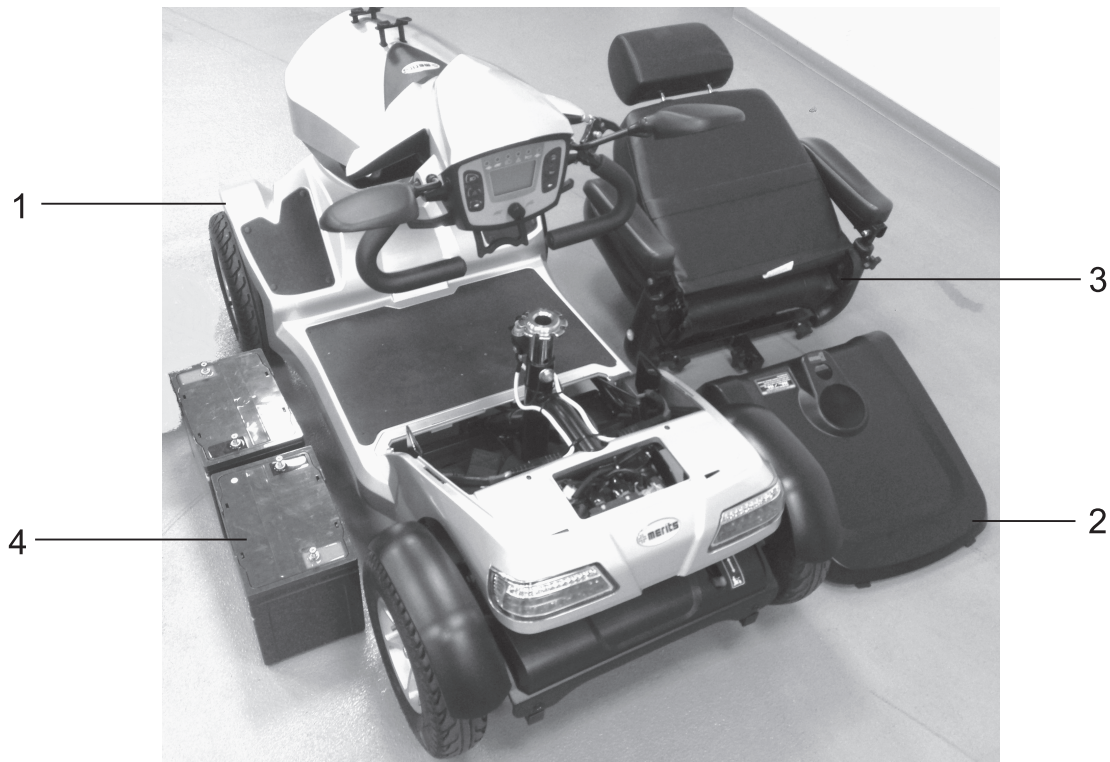

1. Main Frame
2. Battery Shroud
3. Seat
4. Battery



! WARNING

If components of the surface of the product (such as car cover, seat, armrest, joystick handles, etc.) exposure to the sun, this may causing high temperature on the part surface,the high temperatures may cause dangers. Please use the scooter after the tact, when the surface is cool down.

10. IEC SYMBOLS

IEC SYMBOLS	
	Caution, attention or consult accompanying documents.
	Alternating Current
	Type BF Equipment
	Double Insulation
	No Smoking or Naked Flames

Degree of protection against ingress of water is rated as IPx0.

Serialization format for products	
	
1	The first digit is the last one digit of the year for manufacture.
2	The second and third digits are the month for manufacture.
3	The fourth to seventh digits are counting of how many units were manufactured during the month.

11. WARRANTY REGISTRATION

11. WARRANTY REGISTRATION

The scooter expected service life of one year. The main frame has a limited lifetime warranty. If a fault occurs within this period due to faulty workmanship or materials that the product will be repaired free of charge. Any unauthorized modifications will invalidate the warranty. Parts which are subjected to normal wear and tear, accidental damage, neglect or misuse are excluded from this warranty. Normal wear and tear includes tyres, chassis covers, bulbs, seat coverings etc.

WARRANTY REGISTRATION

MODEL NO. _____

SERIAL NO. _____ (The serial No. is to find on the label under the scooter seat.)

DATE PURCHASED _____

NAME _____

ADDRESS _____

CITY _____ STATE _____ ZIP _____

DEALER NAME _____

STAMP

RETURN ADDRESS _____

We wish you a safe and comfortable riding experience!



With you for life



MERITS HEALTH PRODUCTS, INC.

www.meritshealth.com 730 N.E. 19th Place, Cape Coral, FL 33909
TEL:1-800-963-7487, 1-239-772-0579 FAX:1-239-574-2661