

Table of Contents

Introduction

Practice Before Operating	2
---------------------------	---

Safety Instructions

Safety Considerations	4
Driving Outdoors	7
Driving on Various Terrains	9

Familiarize Yourself With Your Powerbase Wheelchair

Feature Diagram	11
P320 Specification	12
Terminology	13
Disassembly	14

Adjusting For Comfort

Adjusting the Joystick	15
Adjusting the Seat Height	15
Adjusting the Armrest Angle	16
Adjusting the Armrest Width	16
Adjusting the Footrest Angle	17

Operating Your Powerbase Wheelchair

Freewheeling	18
Dynamic Shark Controller Operation	19
VR2 Controller Operation	27
Batteries and Charging	32

Index Symbols	35
---------------	----

Warranty

Limited Warranty	36
Troubleshooting Tips	41



Welcome aboard your new powerbase wheelchair, and thank you for choosing our product. Please read this manual carefully, and follow all instructions before attempting to operate your powerbase wheelchair for the first time. If there is anything in this manual that you do not understand, or if you require additional assistance for setting up your powerbase wheelchair, please contact your local dealer.

This latest model is designed for specific practical user needs, combining solid, rugged construction, and modern high-tech electronics, to enhance safety and performance.

With a state-of-the-art, programmable electronic control system, your powerbase wheelchair can be programmed and adjusted within a given range of its performance characteristics, to suit your individual needs. The controller is set up at the factory to give the powerbase wheelchair nominal operating performance characteristics.

After becoming familiar with the basic operation of the powerbase wheelchair, you may wish to customize the settings to fit your own personal preferences. A wide range of customization options can be adjusted such as acceleration, deceleration, maximum speed, turning speed, safety controls, better maneuverability of the joystick, and so on. Contact your local dealer for advice on additional equipment you may need.

Having your powerbase wheelchair checked regularly by your local dealer is the best way to ensure smooth operation, and safety.

This manual provides users practical tips and information on safety issues, operation, and maintenance. Please read it very carefully to ensure your maximum enjoyment and to fully benefit from your independence and mobility.

Whenever special advice or attention is needed, please do not hesitate to contact your local dealer, who has the tools and know-how to provide expert servicing for your powerbase wheelchair.

Your satisfaction and opinions are highly valued by both your local dealer and Merits. Please be sure to fill out the enclosed guarantee form, and return it to your local dealer. The information is necessary for providing you with the best service, and to be sure all of your needs are met.

Failure to follow these instructions may result in damage to the powerbase wheelchair or serious injury.

■ Practice Before Operating

Find an open area such as a park and have an assistant to help you practice until you have confidence operating this vehicle.

Make sure that the power is off before getting in or out of the seat. Set the speed control button according to your driving ability.

We recommend that you keep the speed control at the slowest position until you are familiar with the driving characteristics of this vehicle.

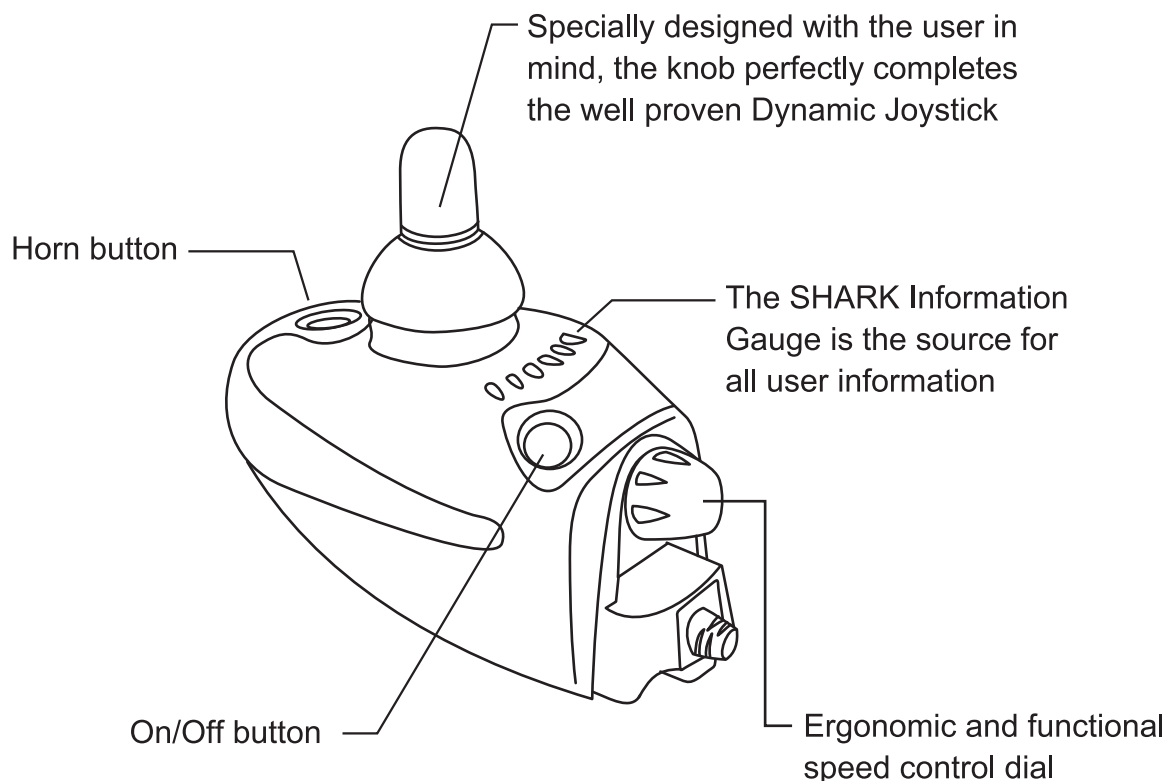
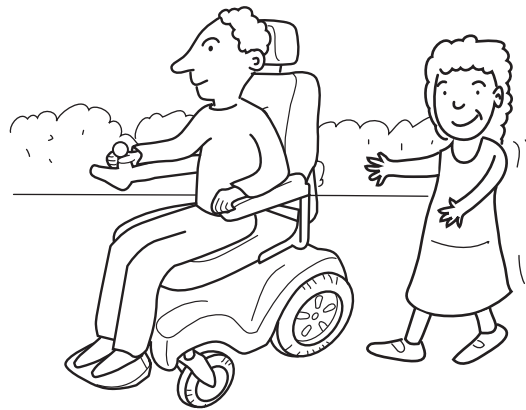

Getting familiar with this vehicle

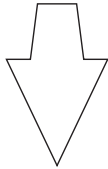
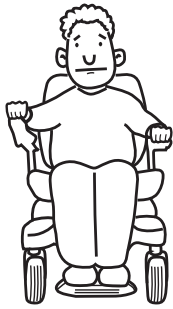

**First, practice moving forward.
Be sure to set the speed to the lowest setting.**

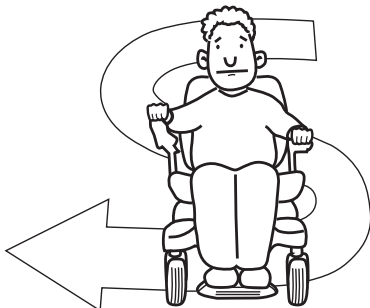

**After becoming familiar with moving forward,
practice making "S" turns.**



**Once you are familiar with "S" turns, practice
moving in reverse. Note that at any speed control
setting, the vehicle moves more slowly in reverse
than forward**

■ Safety Considerations

DO NOT do any of the following



NO!

Do not carry any passengers



NO!

Do not drive across a slope



NO!

Do not drink and drive
Consult your physician to determine, if your medications impair your ability to control this vehicle



NO!

Do not tow a trailer



NO!

Do not turn on or use hand-held personal communication devices such as citizens band(CB) radios and cellular phones

This vehicle has an immunity level of 20 v/m which should protect it from Electromagnetic Interference(EMI) from radio wave sources. The rapid development of electronics, especially in the area of communications, has saturated our environment with electromagnetic (radio) waves that are emitted by television, radio and communication signals. These EM waves are invisible and their strength increases as one approaches the source. All electrical conductors act as antennas to the EM signals and, to varying degrees, all power wheelchairs and power scooters are susceptible to electromagnetic interference (EMI). This interference could result in abnormal, unintentional movement and/or erratic control of the vehicle. The United Statement is incorporated to the user's manual for all electric power wheelchairs.

Powered wheelchairs and electric power scooters (in this text, both will be referred to as powered wheelchairs) may be susceptible to electromagnetic interference (EMI), which is interfering electromagnetic energy emitted from sources such as radio stations, TV stations, amateur radio (HAM) transmitters, two-way radios and cellular phones. The interference (from radio wave sources) can cause the powered wheelchair to release its brakes, move by itself or move in unintended directions. It can also permanently damage the powered wheelchair's control system. The intensity of the EM energy can be measured in volts per meter(V/m). Each powered wheelchair can resist EMI up to a certain intensity. This is called the "immunity level." The higher the immunity level, the greater the protection. At this time, current technology is capable of providing at least 20 V/m of immunity level which would provide useful protection against common sources of radiated EMI.

Following the warnings listed below should reduce the chance of unintended brake release or powered wheelchair movement that could result in serious injury:

- 1) Do not turn on hand-held personal communication devices such as citizens band (CB) radios and cellular phones while the powered wheelchair is turned on.
- 2) Be aware of nearby transmitters such as radio or TV stations and try to avoid coming close to them.

- 3) If unintended movement or brake release occurs, turn the powered wheelchair off as soon as it is safe.
- 4) Be aware that adding accessories or components, or modifying the powered wheelchair, may make it more susceptible to interference from radio wave sources. (Note: there is no easy way to evaluate their effect on the overall immunity of the powered wheelchair).
- 5) Report all incidents of unintended movement or brake release to the powered wheelchair manufacturer, and note whether there is a radio wave source nearby.

TURN OFF YOUR POWER WHEELCHAIR AS SOON AS POSSIBLE WHEN EXPERIENCING ANY OF THE FOLLOWING:

1. Unintentional motions.
2. Unintended or uncontrollable direction.
3. Unexpected brake release.

The FDA has written to the manufacturers of power wheelchairs, asking them to test their new products to be sure they provide a reasonable degree of immunity against EMI. The letter says that powered wheelchairs should have an immunity level of at least 20 V/m, which provide a reasonable degree of protection against the more common sources of EMI. The higher the level, the greater the protection.

■ Driving Outdoors

When you are on the road, please pay attention to the following:



NO!

Do not drive in traffic.



NO!

Do not drive beside a river, port, or lake without a fence or railing.



NO!

If possible, do not drive during the rain.



NO!

If possible, do not drive during or on snow.



NO!

Do not drive off-road or on any uneven surfaced roads.



NO!

If possible, do not drive at night.

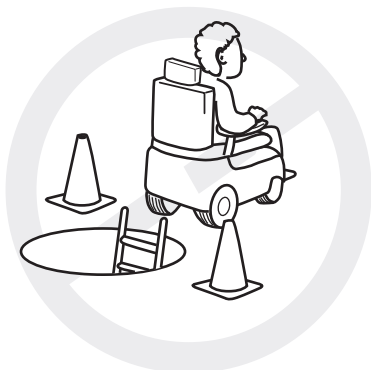

NO!

Make sure that there are no obstacles behind you when in reverse.

We recommend to set the speed at the lowest setting for reversing.



NO!

Do not make sudden stops, weave erratically, or make sharp turns.



NO!

Keep your arms on or inside the armrests and feet on the footrest at all time.

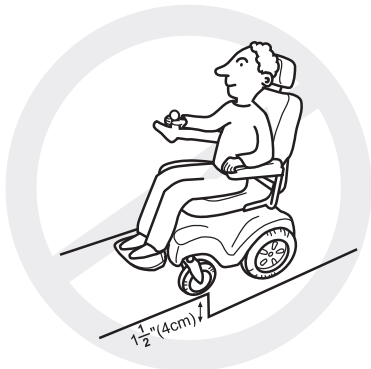

NO!

Do not attempt to climb curbs greater than 1 1/2" (4cm).

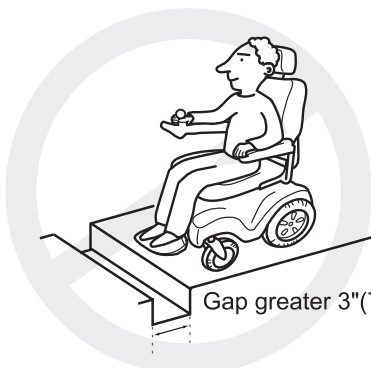

NO!

Do not attempt to cross over a gap greater than 3" (7.5cm).

Gap greater 3" (7.5cm)

■ Diving on Various Terrains

Driving on hills is more dangerous than on level surfaces. If you fail to heed these warnings, a fall, tip-over or loss of control may occur and cause severe injury to the vehicle user or others.



NO!

Do not attempt to climb a hill greater than 8°



NO!

Do not reverse while driving up a hill.

Forward only. If you reverse while moving up a hill, it may cause the vehicle to tip over.



NO!

Do not attempt to drive across a sloping surface greater than 3°

Driving across a slope greater than 3° is very dangerous and may cause the vehicle to tip over.



NO!

Do not drive over soft, uneven or unprotected surfaces such as grass, gravel and decks.

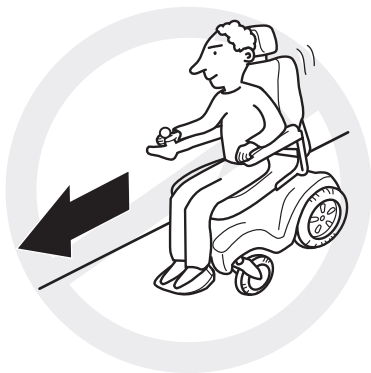

NO!

Use low speed while driving down hill.

When braking while moving down hill, the wheelchair will take longer to come to a complete stop.



NO!

Do not get on and off on a hill.

Always stop on the level surface to get in and get out of the vehicle.

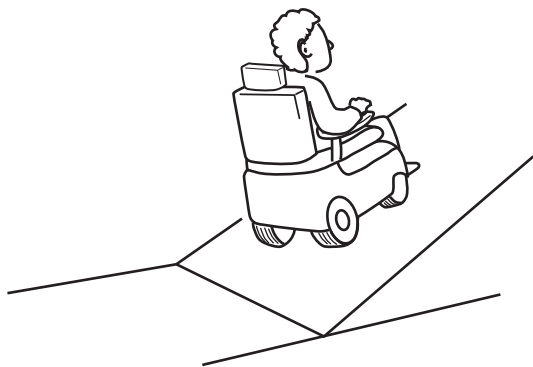

YES!

Always climb or descend gradients perpendicular to the slope or ramp.

Familiarize yourself with your powerbase wheelchair

■ **Feature Diagram**

In this section, we will acquaint you with the many features of your powerbase wheelchair and how they work. Upon receipt of your powerbase wheelchair, inspect it for any damage. Your powerbase wheelchair consists of the following components.

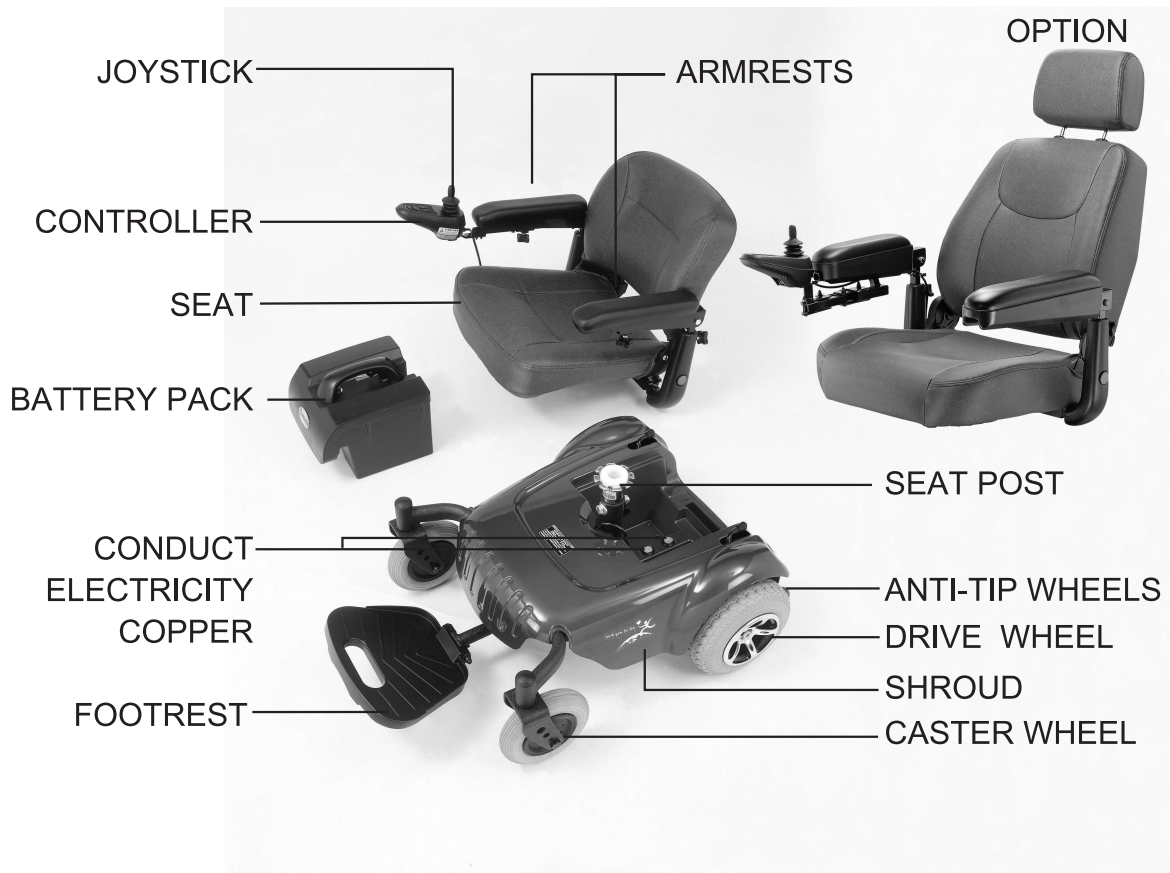

DISASSEMBLY

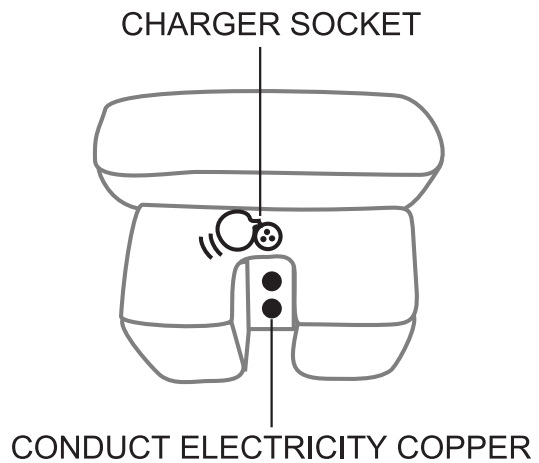
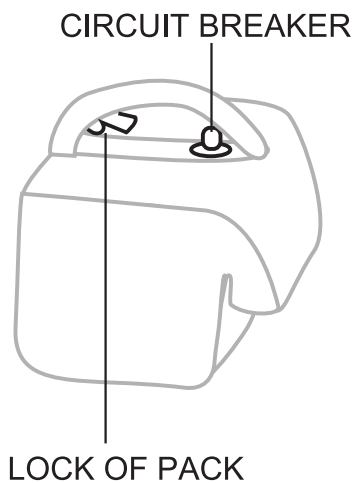

■ P320 Micro Compact Powerbase Wheelchair Specifications



For Fish-On



For Captain

Model No.	P320 Specifications	
Length	32.5" (825mm)	
Width	23" (580mm)	
Seat	Fish-On 18" (460mm)	Captain 18"W (460mm)
Seat Height(from deck)	15"~17" (380~430mm)	
Seat Height(from ground)	18"~20" (460~510mm)	
Speed	3.5 mph (5.6 kph)	
Weight Capacity	300 lbs (136 kg)	
Total Weight(without battery)	79 lbs (35.8 kg)	
Motor	DC24V, 120W, 4000rpm	
Controller	Dynamic Shark / PG VR2 40A	
Battery	12V, 20Ah * 2 pcs	
Charger	3A off board	
Gradient	6°	
Front Wheel	7*1-3/4" Pneumatic or PU	
Rear Wheel	9" Pneumatic or PU	

■ Terminology

Joystick: The device used to "move" the powerbase wheelchair.

Controller: The device that allow joysticks to function. Not all joysticks have a controller.

Armrests: Where arms can rest during time spent on powerbase wheelchair.

Footrest: Where feet rest during time spent on the powerbase wheelchair.

Drive Wheel: The wheels that move the powerbase wheelchair. These are the main wheels.

Caster Wheel: The back wheels.

Controller Harness Connectors: Joystick cables connect to the powerbase wheelchair.

Freewheel Lever: For convenience, your powerbase wheelchair is equipped with freewheel levers. These levers allow you to disengage the drive motors and maneuver the chair manually.



WARNING: DO NOT use the powerbase wheelchair without the presence of an attendant while the drive motors are disengaged! **DO NOT** disengage the drive motors when your powerbase wheelchair is on an incline, as the chair could roll down on its own, causing injury!

To engage or disengage the drive motors:

1. Turn the freewheel levers inward to disengage the drive motors.
2. Turn the freewheel levers toward the front of the powerbase wheelchair to engage the drive motors.

Note: It is important to remember that when the powerbase wheelchair is in the freewheel mode, the braking system is disengaged.

■ Disassembly of the Powerbase wheelchair

To remove the seat:

1. Disconnect communication bus from shroud.
2. Take off the seat from the seat post vertical.
3. Press the lock to take off the battery box.

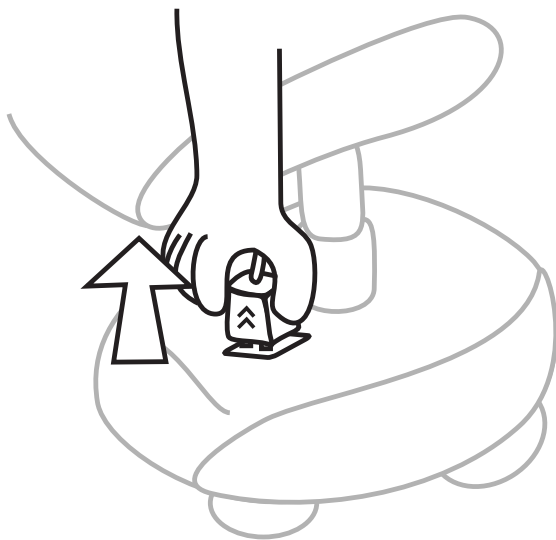

Disconnect Communication Bus

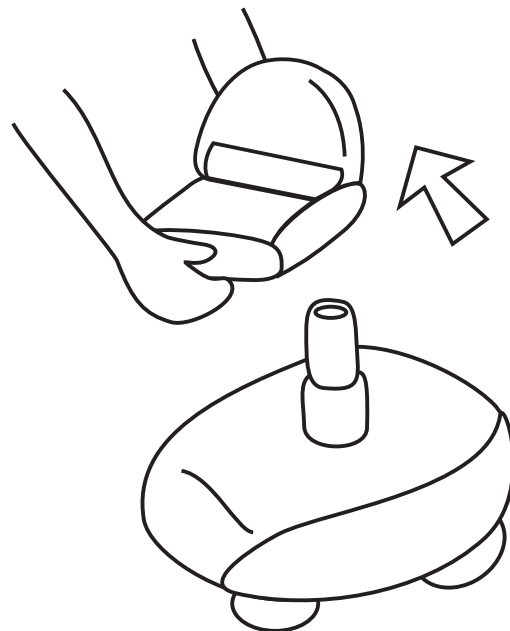

Take off the seat



Take off the Battery Pack

Adjusting for Comfort

■ Adjusting the Joystick:

You can position the joystick for either left-hand or right-hand use:

To change the joystick position:

1. Do not disconnect the joystick communication bus from the shroud.
2. Push tie-mount that attaches the joystick cable to the armrest.
3. Loosen the knob to slide the joystick mounting out of the armrest and place it in the other armrest.
4. Tighten the knob.
5. Connect the joystick cable to the armrest on the clamp tie-mount.

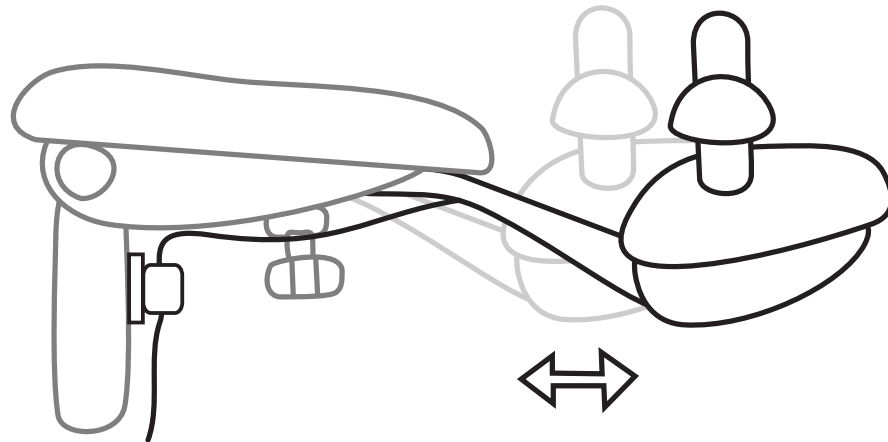

PUSH (CLAMP) TIE-MOUNT

LOOSEN THE KNOB TO ADJUST JOYSTICK

■ Adjusting the Seat Height:

To adjust the seat height:

1. Turn the power off.
2. Disconnect the main cable and remove the seat.
3. Using two 17mm wrenches, remove the bolt securing the inner seat pedestal.
4. Slide the inner pedestal to the desired height and reinsert the bolt.
5. Tighten the bolt and replace the seat.

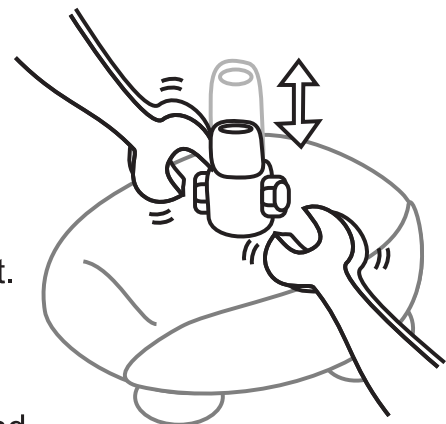

■ Adjusting the Armrest Angle:

You can increase or decrease the armrest angle to fit your specific needs.

To change the tilt angle:

1. Lift the armrest straight up so that it is perpendicular to the floor.
2. Use the Allen wrench to loosen the jam nut.
3. Use the Allen wrench to loosen the adjustment screw.
4. Turn the set nut counter-clockwise to raise the armrest and clockwise to lower the front of armrest.

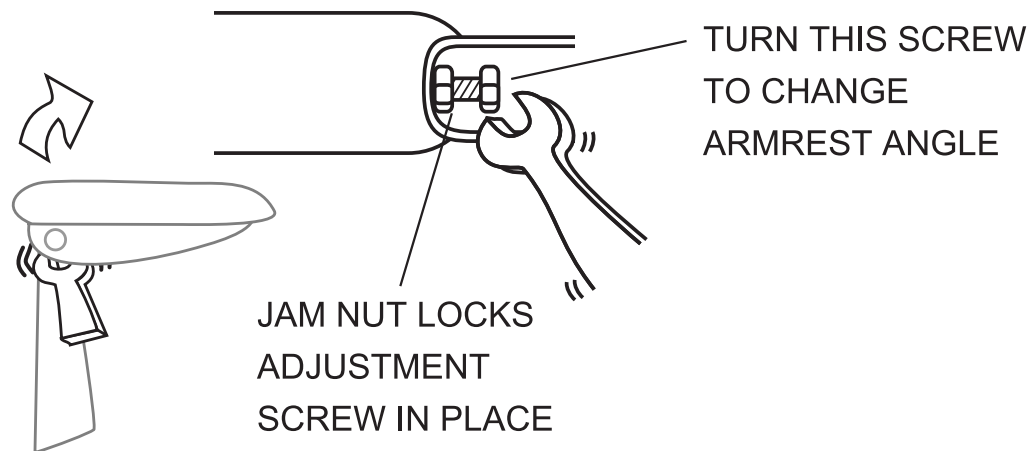

■ Adjusting the Armrest Width:

To change the tilt angle:

1. Locate the two knobs on the armrest receiver bracket.
2. Loosen the knobs and slide the armrests in or out to the desired width.
3. Tighten the knobs.

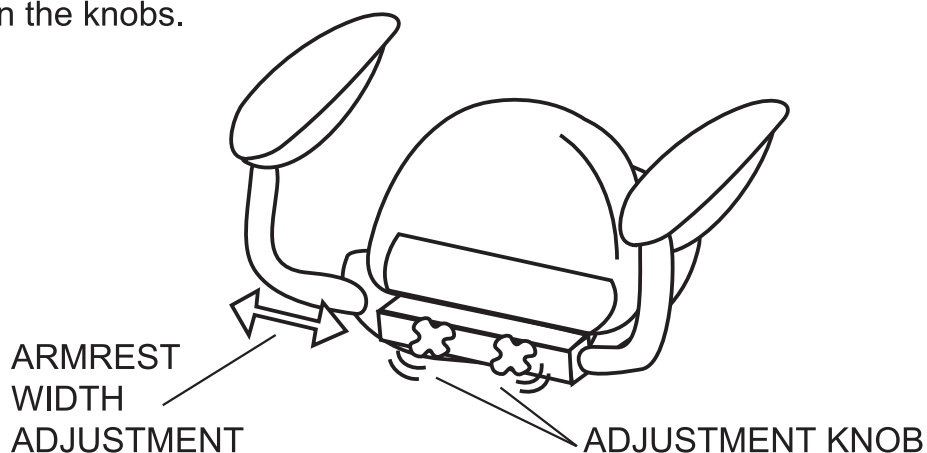

■ Adjusting the Footrest Angle:

You can adjust the angle of the footrest with the Allen wrench.

To adjust the footrest angle:

1. Flip up the armrest for easy access.
2. With an Allen Wrench, simply turn the bolt clockwise to increase the angle or counter-clockwise to decrease it.

JAM NUT LOCKS
ADJUSTMENT
SCREW IN PLACE

TURN THIS
SCREW TO
CHANGE

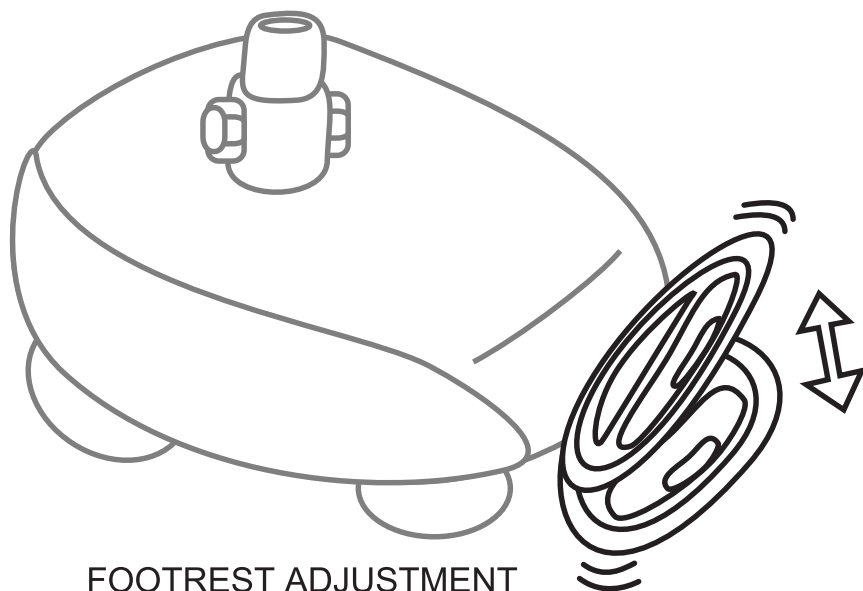
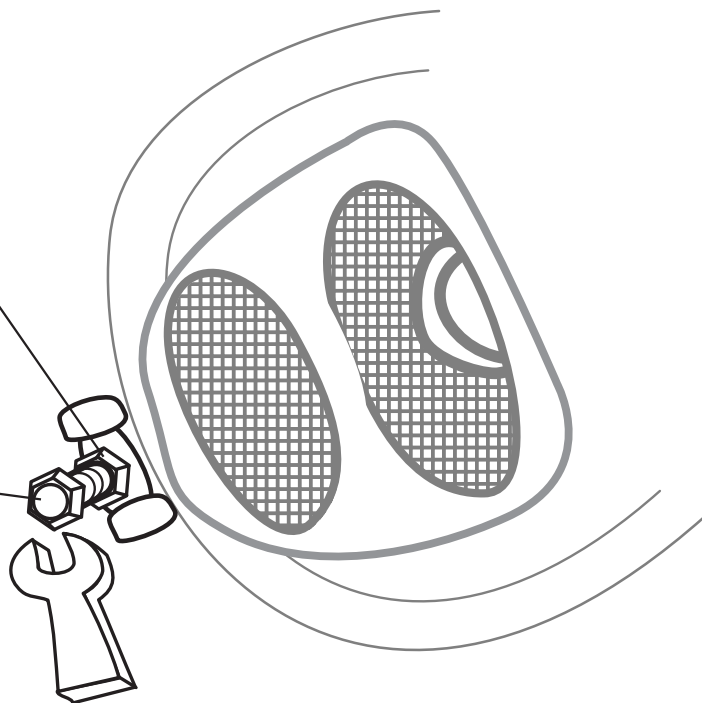

Operating your powerbase wheelchair

■ **Freewheeling:**

Because the motors are designed to engage the electromagnetic brakes when the vehicle is not in use or when the power is OFF, they also have a manual feature that allows them to "free-wheel". Free-wheel is accomplished by turning the free-wheel levers to the release position as shown.

The drive motors to engage or disengage:

1. Turn the freewheel levers toward the front to engage the drive motors.
2. Turn the freewheel levers outward to disengage the drive motors.

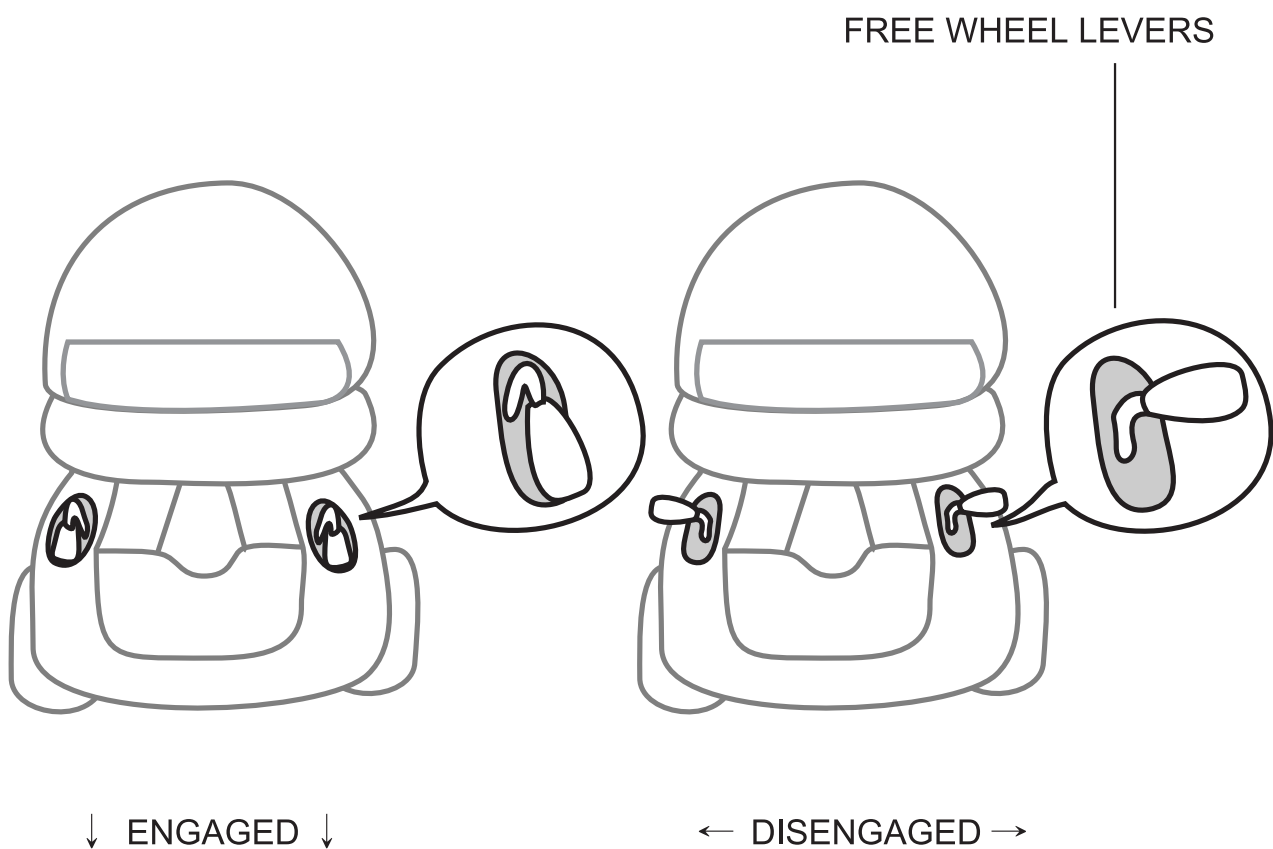

■ **Dynamic Shark Controller Operation:**

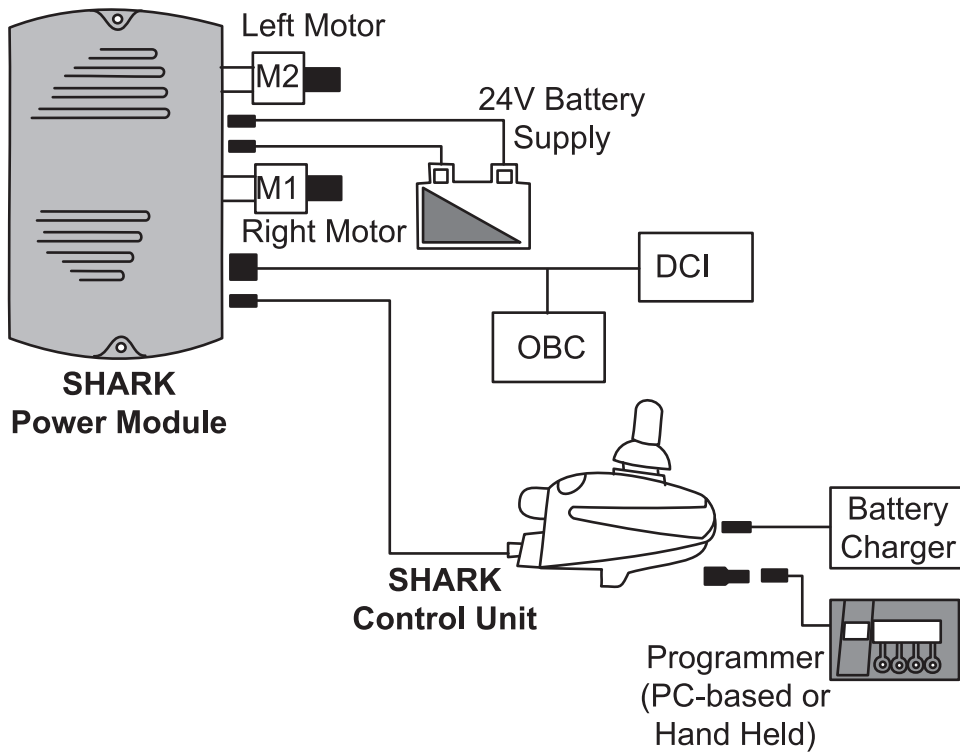

Shark Controller Introduction

The Shark Controller Unit

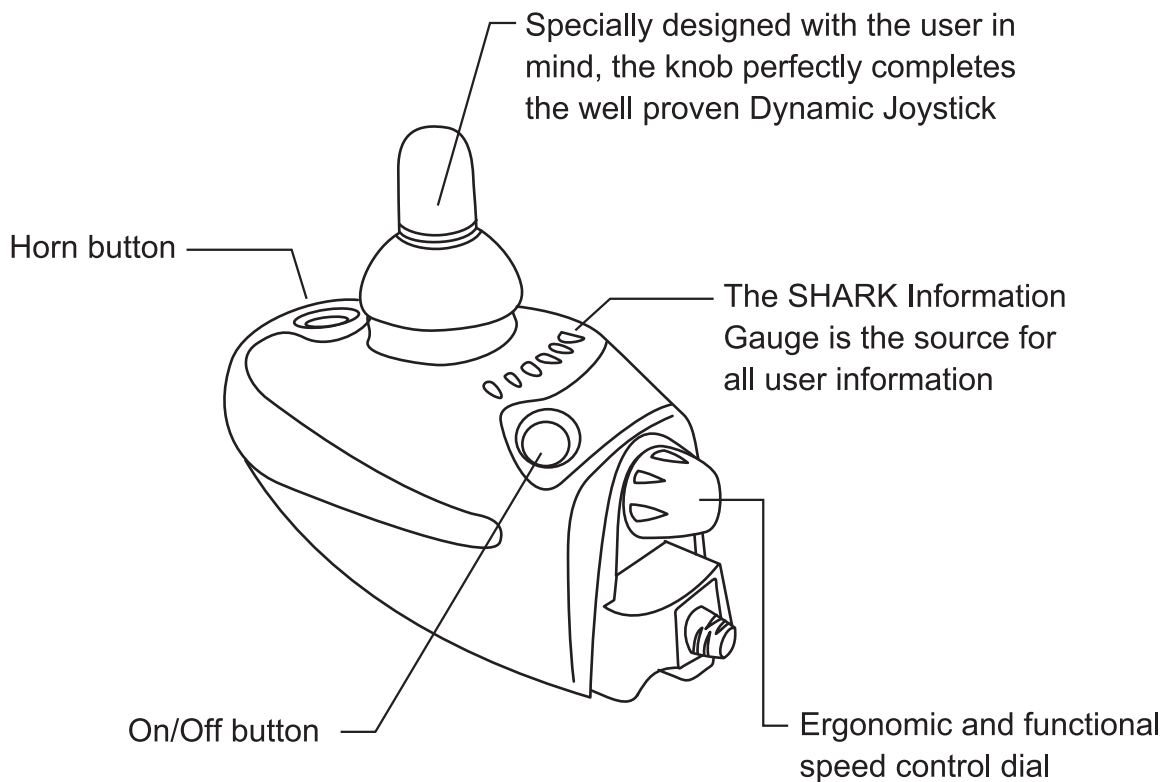

The Shark Information Gauge

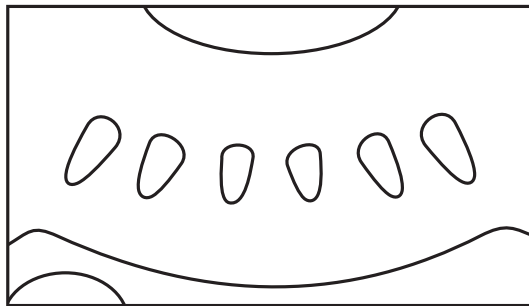

The SHARK Information Gauge is the primary source of user feedback. It displays every possible status that SHARK may have, including;

- SHARK Power ON

True state-of-battery-charge, including notification of when the battery desperately requires charging.

- **Any green** LED's lit indicates well-charged batteries.

- If only **amber and red** LED's are lit, the batteries are moderately charged. Recharge before undertaking a long trip.







- If **only red** LED's are lit, the batteries are running out of charge. Recharge as soon as possible.

- SHARK Lock Mode countdown

- Program, inhibit or charge modes

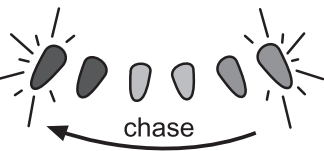
- Fault indication (Flash Codes)

The following table indicates what the gauge will display for any given state.

Display	Description	This means...	Notes
	All LED's OFF	Power is OFF	
	All LED's ON steady	Power is ON	Less LED's imply a reduced battery charge.
	Left RED LED is flashing	Battery charge is low	The batteries should be charged as soon as possible.
	Right to left 'chase'	SHARK is being brought out of Lock mode	To unlock SHARK, press the Horn button twice within 10 seconds.
	Left to right 'chase' alternating with steady display	SHARK is in programming, inhibit and/or charging mode	The steady LED's indicate the current state of battery charge.
	Right GREEN LED is flashing	SHARK is in SPEED LIMIT mode	The current state of battery charge will be displayed at the same time.
	All LED's flashing slowly	SHARK has detected an Out Of Neutral At Power Up (OONAPU) condition	Release the joystick back to neutral.
	All LED's flashing quickly	SHARK has detected a fault	SHARK uses Flash Codes to indicate faults. Refer to the Diagnostics section for further information about fault diagnostics.

The Shark Communications Bus

The SHARK Power Module communicates to the Control Unit through the SHARK Communications Bus. The Bus also supplies power to the Control Unit. The connector is 'keyed' and can only be plugged in one way - the control Unit symbol on top of the plug should be facing up.

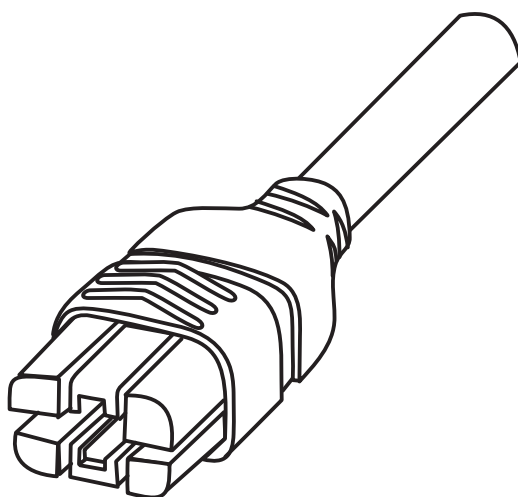

Turning the Power ON

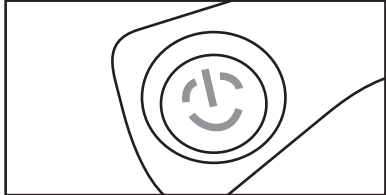
	<p>Press the Power button.</p> <p>All indicators will light briefly.</p> <p>Either the current battery charge or Lock Mode will then be indicated.</p>
---	--

Turning the Power OFF

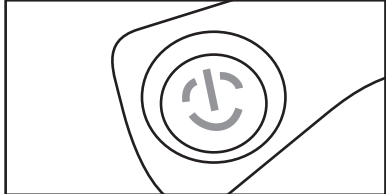
	<p>Press the Power button.</p> <p>The LED's will turn off.</p>
---	--



The Power button can also be used to turn SHARK off in case of an emergency.

	<p>After a certain amount of time with no joystick movement SHARK will automatically turn itself off. Sleep mode will not be entered while programming.</p> <p>Any button press (or joystick movement if Wakeup style has been set to "Joystick or Button") will bring the system out of sleep mode.</p>
---	--

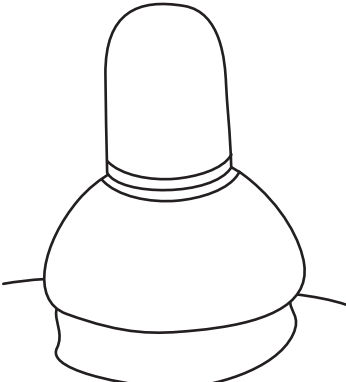
	<p>Moving the joystick will cause the powerchair to drive in that direction. The amount of joystick movement will determine the speed that the powerchair will move in that direction.</p>
--	--

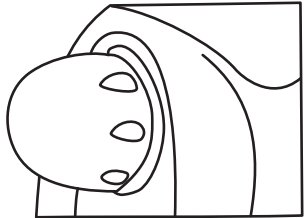
	<p>A user may adjust the top speed of their powerchair to suit their preference or environment by turning the speed control dial.</p> <p>Simply turn the dial fully clockwise to travel at top speed when the joystick is pushed fully forward. The top speed progressively reduces as the dial is turned counter-clockwise.</p>
---	--

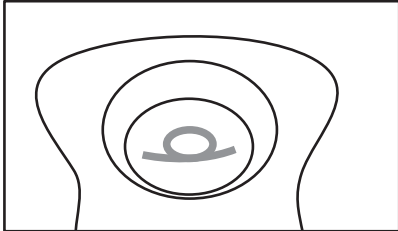
	<p>Press the Horn button.</p> <p>The horn will sound for as long as the button is pressed.</p>
---	--



Flash codes indicate the nature of an abnormal condition directly from the SHARK Information Gauge. Without the use of any servicing tools, the condition can be simply diagnosed.

Flash Code	Description	
1	User Fault	Possible stall timeout or user error. Release the joystick to neutral and try again.
2	Battery Fault	Check the batteries and cabling. Try charging the batteries. Batteries may require replacing.
3	Left Motor Fault	Check the left motor, connections and cabling.
4	Right Motor Fault	Check the right motor, connections and cabling.
5	Left Park Brake Fault	Check the left park brake, connections and cabling.

Flash Code	Description	
6	Right Park Brake Fault	Check the right park brake, connections and cabling.
7	SHARK Control Unit Fault	Check the SHARK Communications Bus connections and wiring. Replace the Control Unit.
8	SHARK Power Module Fault	Check SHARK connections and wiring. Replace the Power Module.
9	SHARK Communications Fault	Check SHARK connections and wiring. Replace the SHARK Control Unit.
10	Unknown Fault	Check all connections and wiring. Consult a service agent.
11	Incompatible Control Unit.	Wrong type of Control unit connected. Ensure the branding of the Power Module matches that of the Control Unit.

■ VR2 Controller Operation:

The VR2 control system has two versions of the front control panel - with and without actuator control. Most of the controls are common to both versions, however, the actuator buttons are only included on VR2 control systems with seat actuator control. Each of the controls is explained within this section.

VR2 USER CONTROLS

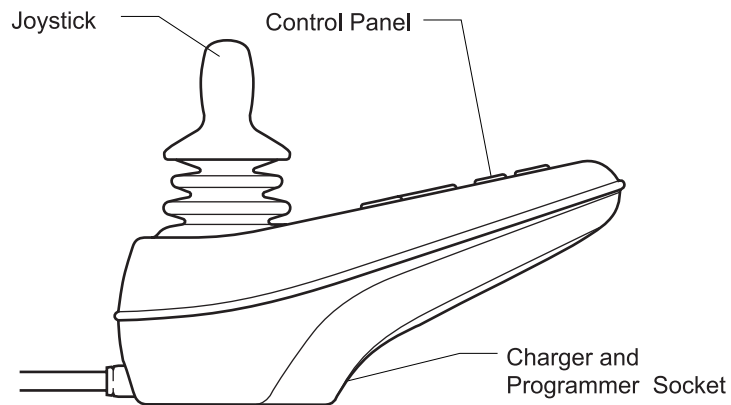

Front Control Panel Details

No Actuators

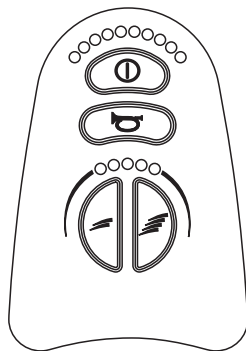

With Actuators

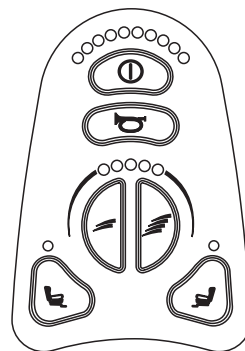

VR2 CONTROL BUTTONS



Battery Gauge



On/Off Button



Horn Button

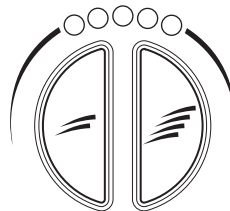

Maximum Speed / Profile Indicator

Speed / Profile Decrease Button

Speed / Profile Increase Button



Actuator Buttons

On/Off Button and Battery Gauge

The on/off button applies power to the control system electronics, which in turn supply power to the wheelchair's motors. Do not use the on/off button to stop the wheelchair unless there is an emergency. (If you do, you may shorten the life of the wheelchair drive components).

The battery gauge shows you that the wheelchair is switched on. It also indicates the operating status of the wheelchair. Details are given in section 1.

1 Control System Status Indication

The battery gauge and maximum speed / profile indicator show the status of the control system.

A number of supposedly defective control systems returned to us are subsequently found to operate correctly. This indicates that many reported faults are due to wheelchair problems rather than the control system.

1.1 Battery Gauge is Steady

This indicates that all is well.

1.2 Battery Gauge Flashes Slowly

The control system is functioning correctly, but you should charge the battery as soon as possible.

1.3 Battery Gauge steps Up

The wheelchair batteries are being charged. You will not be able to drive the wheelchair until the charger is disconnected and you have switched the control system off and on again.

1.4 Battery Gauge Flashes Rapidly (even with the joystick released)

The control system safety circuits have operated and the control system has been prevented from moving the wheelchair.

This indicates a system trip, i.e. the VR2 has detected a problem somewhere in the wheelchair's electrical system. Please follow this procedure.

- Switch off the control system.
- Make sure that all connectors on the wheelchair and the control system are mated securely.
- Check the condition of the battery.
- If you can't find the problem, try using the self-help guide given in section 1.6.
- Switch on the control system again and try to drive the wheelchair. If the safety circuits operate again, switch off and do not try to use the wheelchair.

Contact your service agent.











1.5 Self-Help Guide

If a system trip occurs, you can find out what has happened by counting the number of bars on the battery gauge that are flashing.

Below is a list of self-help actions. Try to use this list before you contact your service agent. Go to the number in the list which matches the number of flashing bars and follow the instructions.

If the problem persists after you made the checks described above contact your service agent.

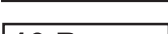
* If the programmable parameter, Motor Swap has been enabled, then left and right hand references in this table will need transposing.

- | | |
|---|--|
| 1 Bar
 | The battery needs charging or there is a bad connection to the battery. Check the connections to the battery. If the connections are good, try charging the battery. |
| 2 Bar
 | The left hand motor* has a bad connection. Check the connections to the left hand motor. |
| 3 Bar
 | The left hand motor* has a short circuit to a battery connection. Contact your service agent. |
| 4 Bar
 | The right hand motor* has a bad connection. Check the connections to the right hand module. |
| 5 Bar
 | The right hand motor* has a short circuit to a battery connection. Contact your service agent. |
| 6 Bar
 | The wheelchair is being prevented from driving by an external signal. The exact cause will depend on the type of wheelchair you have, one possibility is the battery charger is connected. |
| 7 Bar
 | A joystick fault is indicated. Make sure that the joystick is in the center position before switching on the control system. |
| 8 Bar
 | A control system fault is indicated. Make sure that all connections are secure. |
| 9 Bar
 | The parking brakes have a bad connection. Check the parking brake and motor connections. Make sure the control system connections are secure. |
| 10 Bar
 | An excessive voltage has been applied to the control system. This is usually caused by a poor battery connection. Check the battery connections. |
| 7 Bar + S
 | A communication fault is indicated. Make sure that joystick cable is securely connected and not damaged. |
| 8 Bar + A
 | An Actuator trip is indicated. If more than one actuator is fitted, check which actuator is not working correctly. Check the actuator wiring. |

1.6 Slow or sluggish movement

If the wheelchair does not travel at full speed or does not respond quickly enough, and the battery condition is good, check the maximum speed setting. If adjusting the speed setting does not remedy the problem then there may be a non-hazardous fault. Contact your service agent.

1.7 Maximum Speed / Profile Indicator is Steady

The display will vary slightly depending on whether the control system is programmed to operate with drive profiles.

1.7.1 Maximum Speed Indication

The number of LEDs illuminated shows the maximum speed setting. For example, if the setting is speed level 4, then the four left hand LEDs will be illuminated.

1.7.2 Profile Indication

The LED illuminated shows the selected drive profile. For example, if drive profile 4 is selected, then the fourth LED from the left will be illuminated.

1.8 Maximum Speed / Profile Indicator Ripples Up and Down

This indicates the control system is locked.

1.9 Maximum Speed / Profile Indicator Flashes

This indicates the speed of the wheelchair is being limited for safety reasons. The exact reason will depend on the type of wheelchair, however, the most common cause is that the seat is in the elevated position.

VR2 POWER MODULE CONNECTIONS

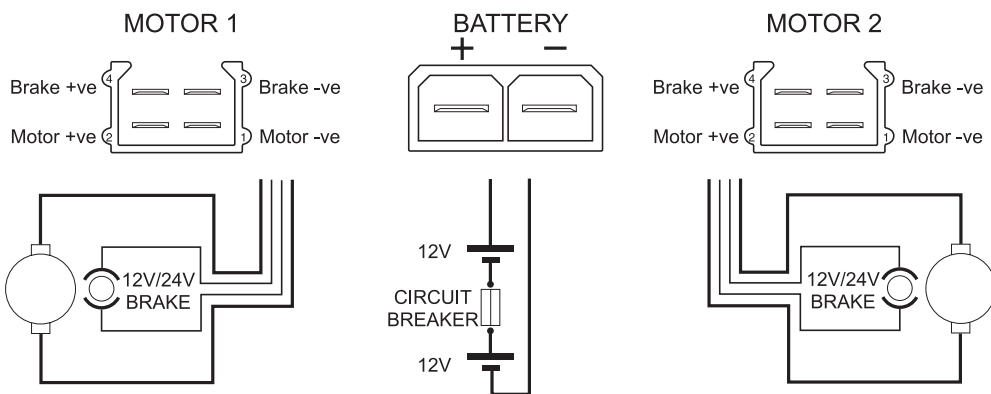
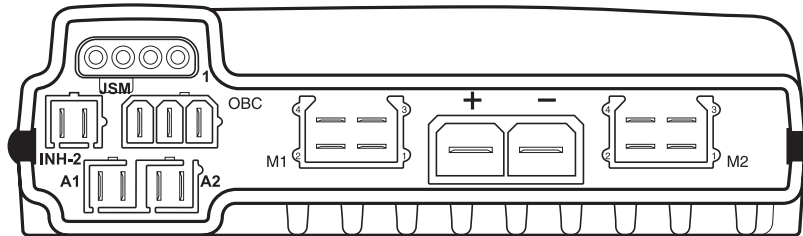

INHIBIT 2

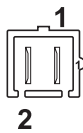

INH-2	Function
1	0V
2	Inhibit 2

ON-BOARD CHARGER

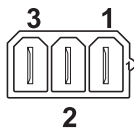

OBC	Function
1	Battery +ve
2	Inhibit 3
3	0V

ACTUATORS

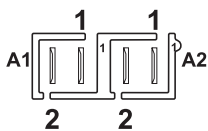

Joystick Movement	Pin 1	Pin 2	Actuator Movement
Forward	+ve	-ve	Channel Up
Backward	-ve	+ve	Channel Down

► Operating your powerbase wheelchair ◀

Batteries and Charging

Your Power Wheelchair uses two long-lasting, 12-volt batteries. These batteries are sealed, maintenance free, deep-cycle batteries. Since they are sealed, there is no need to check the electrolyte (fluid) level. Deep-cycle batteries are designed to handle a deep discharge. Though they are similar in appearance to automotive batteries, they are not interchangeable. Automotive batteries are not designed to handle a long, deep discharge, and are also unsafe for use in power wheelchairs.

WARNING! Battery posts, terminals and related accessories contain lead and lead compounds. Wash hands after handling.

BATTERY BREAK-IN

To break in your power wheelchair new batteries for maximum efficiency:

1. Fully recharge any new battery prior to initial use. This will bring the battery up to about 90% of its peak performance level.
2. Run your power wheelchair about the house and yard. Move slowly at first, and do not stray too far until you become accustomed to the controls and break in the batteries.
3. Give the batteries another full charge of 8 to 14 hours and operate the power wheelchair again. The batteries should now perform at over 90% of their potential.
4. After four or five charging cycles, the batteries will top off at 100% charge and last for an extended period.

IMPORTANT INFORMATION ABOUT BATTERIES

A fully charged deep-cycle battery provides reliable performance and extended battery life. Keep your batteries fully charged whenever possible. Batteries that are regularly discharged, infrequently charged, or stored without a full charge may be permanently damaged, causing unreliable operation and limited battery life.

If you do not use your power wheelchair regularly, we recommend maintaining battery vitality by charging the batteries at least once a week.

Note: If you are storing a power wheelchair for an extended period of time, you may wish to block the unit up off the ground with several boards under the frame. This keeps the tires off the ground to prevent the possibility of flat spots developing.

If you intend to use public transportation while using your power wheelchair, you must contact in advance the transportation provider to determine their specific requirements.

Sealed Lead Acid and Gel Cell batteries are designed for application in wheelchairs and in other mobility vehicles. Generally, Sealed Lead Acid batteries that are marked as "Non-Spill" are safe for all forms of transportation such as aircraft, buses, and trains. We suggest that you contact your transportation provider to determine specific requirements of transportation and packaging.

If you wish to use a freight company to ship the power wheelchair to your final destination, repack the power wheelchair in the original shipping container and ship its batteries in separate boxes.

Charging Your Batteries

The battery charger is one of the most important parts of your power wheelchair. Optimize your power wheelchair performance by charging the batteries safely, quickly, and easily. Use only the charger supplied with the vehicle.





Charging Procedures

1. Keep charger output plug inserted into the charging socket in the front of the controller before having the charger input plugged into an electrical outlet.
2. Follow the instructions on the front panel of the charger for operating and learn the meanings of the different indicators accordingly.
3. Minimum charging time varies depending on battery condition and discharge level. It is recommended to charge the batteries overnight.

NOTE: The specially designed charger assures that excess power is not consumed regardless of how long it is switched on, and connected to the batteries.

4. Once charging is complete, disconnect the charger from the electrical outlet and then disconnect the charger from the controller socket. Do not leave the charger connected to controller when input power is disconnected. It is dangerous and will jeopardize the power charging to the batteries.

IEC SYMBOLS

	Caution, attention or consult accompanying documents.
	Alternating Current
	Type BF Equipment
	Double Insulation
	No Smoking or Naked Flames

Degree of protection against ingress of water is rated as IPx0.

Serialization format for products



1	The first digit is the last one digit of the year for manufacture.
2	The second and third digits are the month for manufacture.
3	The fourth to seventh digits are counting of how many units were manufactured during the month.

► Warranty ◀

Merits Limited Warranty

Merits Corporation warrants to the original purchaser of this wheelchair product that it is free of defect in material and workmanship and that, when operated within the guidelines and restrictions of this manual, will remain so free of defect in material and workmanship for a period of One (1) year from the original date of purchase.

Excluded from this warranty is failure due to negligence, abuse, accident, operation outside of rated limits, commercial or institutional use, damage / wear to upholstery or tires and improper maintenance or storage. The batteries for this wheelchair product are not supplied by Merits Corporation; contact the battery manufacturer / supplier if warranty replacement is requested.

This wheelchair product must not be modified in any way without the express written consent of Merits Corporation. Any such unauthorized modification could cause unreliable and / or unsafe operation and will void this warranty.

Where a failure occurs within the 1- year warranty period that is not excluded above, the failed components will be replaced with similar new or reconditioned components at Merits sole option. Merits Corporation will not be responsible for labor and / or shipping charges.

The foregoing warranty is exclusive and in lieu of all other warranties expressed or implied including, but not limited to, the implied warranty of merchantability and fitness for a particular purpose. Merits Corporation will not be liable for any consequential or incidental damages whatsoever.

► Warranty Registration ◀

**MERITS HEALTH PRODUCTS INC.
WARRANTY REGISTRATION**

MODEL NO. _____

SERIAL NO. _____

DATE PURCHASED _____

NAME _____

ADDRESS _____

CITY _____ STATE _____ ZIP _____

DEALER NAME _____

STAMP

RETURN ADDRESS

MERITS HEALTH PRODUCTS INC.
P.O BOX 150356
CAPE CORAL, FL. 33915

TROUBLESHOOTING TIPS

If your power chair or scooter is not operating properly, please take the following steps prior to calling Technical Support.

Load-test Batteries—See Figure 1

1. Attach Battery Load-tester to battery.
Observe polarity: Red is Positive—Black is Negative
2. Hold load switch on for 10 seconds. A good reading is 11.2 Volts DC, or in the Green.

Note: A Voltmeter cannot load-test batteries.

Test Voltage—See Figure 2

Utilizing a Voltmeter, place meter leads in charging port. The voltage reading should be 25 Volts DC, plus or minus 2 volts.

Note: Batteries are connected in series.

If the above tests are successful, proceed with the following test.

1. For power chairs, place gearbox levers in Freewheel.
2. Turn on controller and run in all four quadrants.
3. If troubleshooting a scooter, elevate rear wheels and run in Forward and Reverse.

If any of the tests fail, call Technical Support for assistance: 1-800-963-7487.



Figure 1



Figure 2