

RT-MINI II

A Self-flashing PV Mount Featuring Roof Tech's AlphaSeal®



RT-MINI II is suitable for all systems with any L-Foot

Conduit Strap Installation

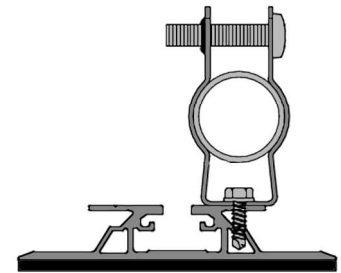

RT2-04-FBN25
Hex Flange Bolt and Nut Set
Required for L-Foot Attachment

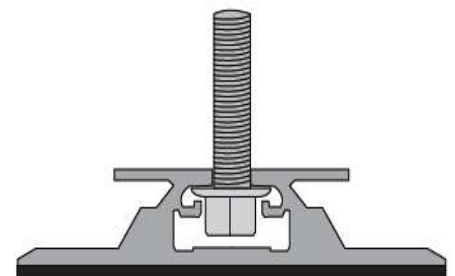

- ✓ No Caulking or Pre-Drilling Required
- ✓ Universal Attachment to Any Slope
- ✓ Metal, EPDM, TPO, SBS, & Asphalt Roofs
- ✓ Wide Range of Applications & Ultimate Flexibility on the Roof
- ✓ No Need to Bend Rails
N-S & Rotational Adjustments



Installation Manual



ICC ESR 3575

Roof Tech

The Standard for Waterproof Flexible Flashing Since 1994

www.roof-tech.us

info@roof-tech.us



RT-MINI II

Flexible Flashing Certified by the International Code Council (ICC)

Components

RT2-00-MINIBK2

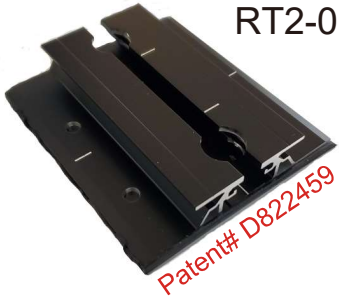

MINI II base : 20 ea.
Screw : 40 ea.
Extra RT-Butyl : 4 ea.

Optional Items:

5 x 60mm Mounting Screw (RT2-04-SD5-60) : 100 ea./Bag
5/16 X 25MM Flange Bolt & Nut (RT2-04-FBN25) : 100 ea./Bag
RT-Butyl (RT2-04-MNBUTYL) : 10 ea./Box

Dimensions in (mm)

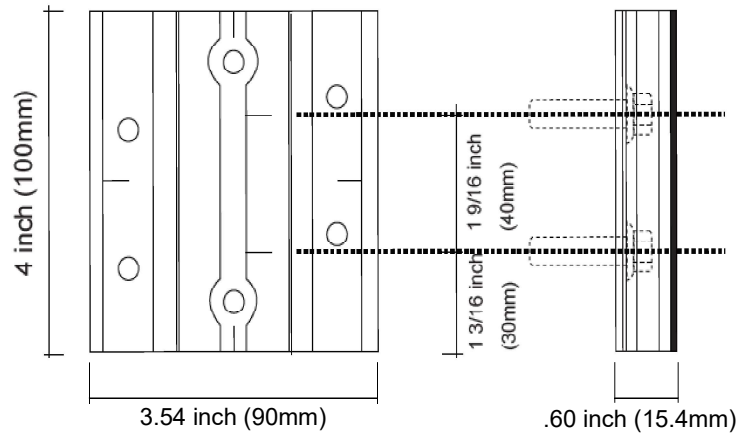

Deck Installation

OSB & PLYWOOD ONLY

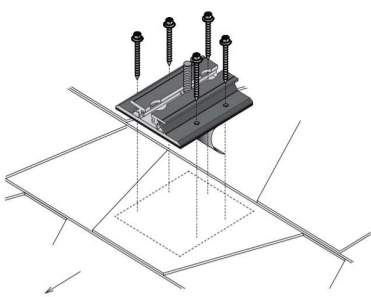

Rafter Installation

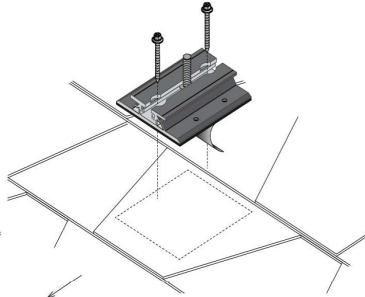

Hybrid Installation

Rafter and Deck

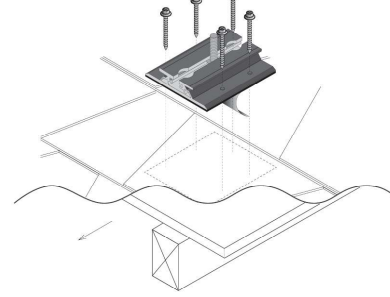

Roof Tech Inc. AlphaSeal™ Technology has been used on over one million residential PV systems since 1994. It is the first PV mounting system with Flexible Flashing certified by the ICC, engineered to withstand wind speeds up to 180 mph and ground snow up to 90 psf.

Engineered to ASTM D 1761

(Standard Test Methods for Mechanical Fasteners in Wood)

ICC ESR-3575

ASTM2140 Testing

P.E. Letters



Support & Downloads



Offset Rafter Attachment Options

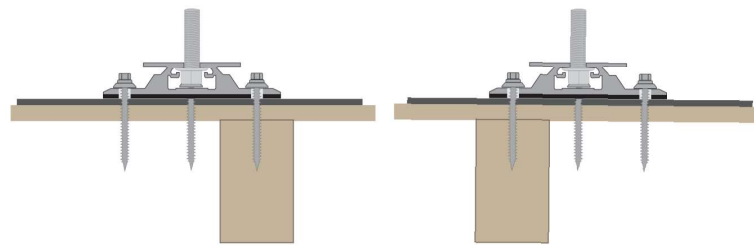

Metal Flashing Retrofit

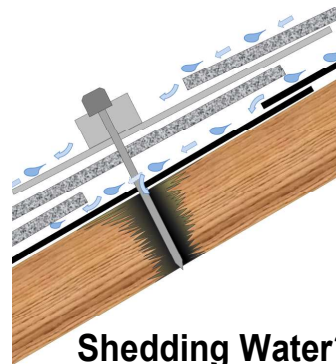

Shedding Water?

Flexible Flashing

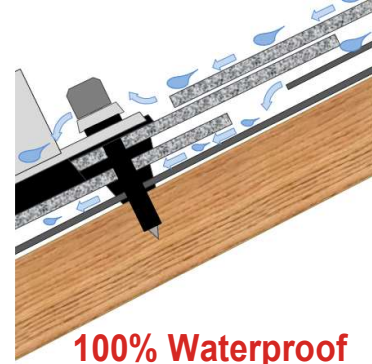

100% Waterproof



Roof Tech Inc.
www.roof-tech.us info@roof-tech.us
10620 Trenea Street, Suite 230, San Diego, CA 92131
858.935.6064