

Race to the Top™ Bouncer • Parc de jeux • Gimnasio inflable
Instructions for Installation and Operation • Instructions d'installation et d'utilisation
Instrucciones de instalación y funcionamiento

Ages: 3 years and up • 3 ans et plus • 3 años adelante

CAUTION - ELECTRICALLY OPERATED PRODUCT.

NOT RECOMMENDED FOR CHILDREN UNDER 3 YEARS OF AGE. AS WITH ALL ELECTRIC PRODUCTS, PRECAUTIONS SHOULD BE OBSERVED DURING USE AND HANDLING TO PREVENT ELECTRIC SHOCK.

ATTENTION – CE PRODUIT FONCTIONNE À L'ÉLECTRICITÉ

IL EST DÉCONSEILLÉ POUR LES ENFANTS DE MOINS DE 3 ANS. COMME AVEC TOUS LES PRODUITS ÉLECTRIQUES, PRENEZ LES PRÉCAUTIONS NÉCESSAIRES POUR MANIPULER ET UTILISER CE PRODUIT AFIN DE PRÉVENIR LES RISQUES DE CHOC ÉLECTRIQUE.

PRECAUCION. PRODUCTO ELECTRICO.

NO SE RECOMIENDA PARA NIÑOS MENORES DE 3 AÑOS DE EDAD. COMO CON TODO PRODUCTO ELECTRICO DEBEN OBSERVARSE CIERTAS PRECAUCIONES DURANTE EL MANEJO Y USO PARA EVITAR CHOQUES ELECTRICOS.

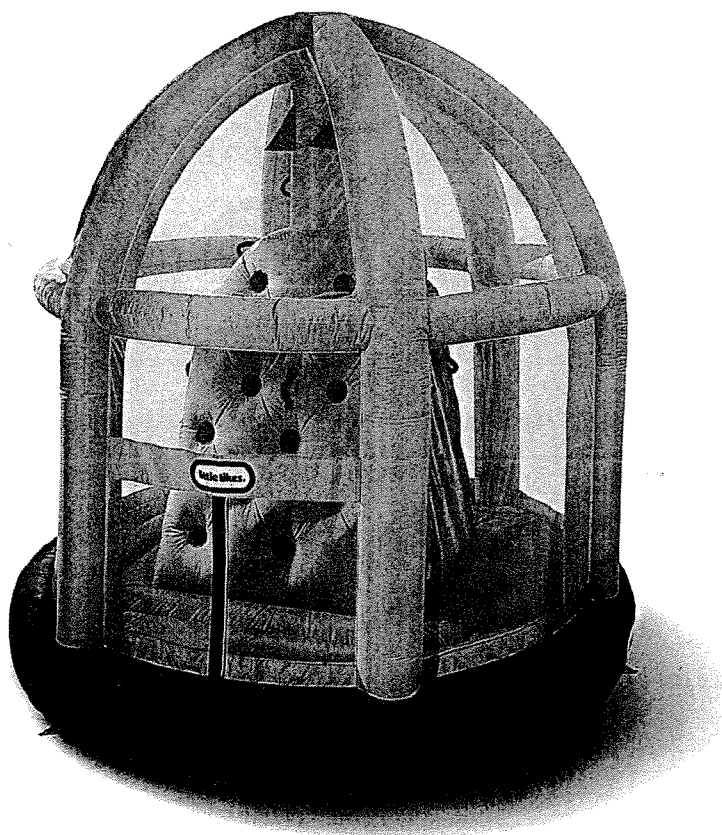

⚠ WARNING: FAILURE TO FOLLOW THESE INSTRUCTIONS COULD RESULT IN SERIOUS INJURY OR DEATH.

- Do not use extension cords with this product.
- Outdoor use only.
- Retain instructions with product.

⚠ AVERTISSEMENT : LE NON RESPECT DE CES INSTRUCTIONS PEUT ENTRAÎNER DES BLESSURES GRAVES, VOIRE MORTELLES.

- N'utilisez pas de cordons prolongateurs avec ce produit.
- N'utilisez ce produit qu'à l'extérieur.
- Conservez les instructions avec le produit.

⚠ ADVERTENCIA: EL NO SEGUIR ESTAS INSTRUCCIONES PUEDE PROVOCAR LESIONES SERIAS O LA MUERTE.

- No utilice cordones de extensión con este producto.
- Uso en exteriores solamente.
- Guarde las instrucciones con el producto.

little tikes

62452G000-10/05

452G

ATTENTION: PLEASE DO NOT RETURN TO THE STORE. IF YOU ENCOUNTER PROBLEMS, OR HAVE QUESTIONS, PLEASE CALL OUR QUALIFIED CUSTOMER SERVICE TECHNICIANS AT 1-800-321-0183.

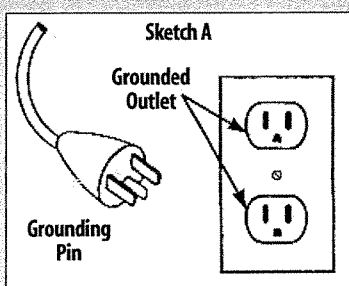

USE ONLY ON GFCI PROTECTED RECEPTACLES **⚠ CAUTION ⚠**
GROUNDING INSTRUCTIONS FOR ALL GROUNDED, CORD-CONNECTED PRODUCTS

This product should be grounded. In the event of an electrical short circuit, grounding reduces the risk of electric shock by providing an escape wire for the electric current. This product is equipped with a cord having a grounding wire with an appropriate grounding plug. This plug must be plugged into an outlet that is properly installed and grounded in accordance with all local codes and ordinances. **DANGER** - Improper installation of the grounding plug can result in a risk of electric shock. If repair or replacement of the cord or plug is necessary, do not connect the grounding wire to either flat blade terminal. The wire with insulation having an outer surface that is green, with or without yellow stripes, is the grounding wire. Check with a qualified electrician or serviceman if the grounding instructions are not completely understood, or if in doubt as to whether the product is properly grounded. Do not modify the plug provided; if it will not fit the outlet, have the proper outlet installed by a qualified electrician. For a grounded, cord-connected product, rated less than 15 amperes and intended for use on a nominal 100-120-volt supply circuit, these instructions should be followed. This product is for use on a nominal 100-120-volt supply circuit, and has a grounding plug that looks like the plug illustrated in sketch A. Temporary adapters should not be used. Do not use product until a properly grounded outlet (sketch A) can be installed by a qualified electrician.

⚠ WARNING: FAILURE TO FOLLOW THESE INSTRUCTIONS COULD RESULT IN SERIOUS INJURY OR DEATH.



ADULT SUPERVISION AND SETUP REQUIRED. This product should be inflated or deflated only by an adult.

- Do not allow children to play in the product until it is fully inflated.
1. **ATTENTION:** Blower should remain on and continuously inflate bouncer during use. Airflow through seams is normal. Do not try to seal or repair seams.
 2. To deflate, switch to the "OFF" position.
 3. Prior to deflating, remove all children.
- Intended for outdoor domestic family use only. Not for use in public areas or as a rental.
 - Instruct children on proper use of this product. Do not use in a manner other than intended.
 - Instruct children not to attach items to the product that are not specifically designed for use with the equipment, such as but not limited to, jump ropes, clothesline, pet leashes, cables and chains as they may cause a strangulation hazard.
 - Bounce away from others and sides, especially the opening.
 - Do not jump onto or off of product.
 - Ensure proper set up prior to use.
 - Do not allow children to play together who are unevenly matched in weight and height.
 - Keep fabric clear of all flame and ignition sources.
 - Do not drag across concrete, pavement or other rough surfaces.
 - Retain these instructions for future use.
 - Helmets, headgear, loose clothing, scarves, hoods, or clothing containing drawstrings should not be worn when using this product.
 - Do not allow other toys or objects inside the product.
 - Keep pets away from product.

⚠ SET UP: ADULTS ONLY
DO NOT SET UP ON HARD SURFACES. FOLLOW ALL INSTRUCTIONS PROVIDED.

- ⚠ WARNING:** Falls onto hard surfaces could result in head or other serious injuries. Never put on concrete, asphalt, packed earth, wood or other hard surfaces. Carpet over hard floors may not prevent injury. Product is heavy. Use caution when lifting.
- Do not use extension cords with this product.
 - Set-up in outdoor location only that meets the following criteria:
 - Place on level ground on grass or dirt surface to allow proper use of stakes.
 - Minimum clearance zones: Place at least 6' (1.8m) away from any other objects. Objects to be avoided include but are not limited to fences, buildings, trees, overhead branches, laundry lines, electrical wires, walls, or bodies or sources of water.
 - Placing on slanted or uneven surfaces may cause the product to tip.
 - Sudden gusts of wind may lift the product off of the ground.
 - After inflation, the fan should run continuously while children are playing.
- CAUTION:** The fan is a high volume fan, and is capable of moving lots of air very quickly. Place the fan in an area where it will not suck in dirt or leaves. Keep fan and power cord away from children, water, pools, spas and traffic.
- NOTE:** Set up as close to power source as possible. The product should be periodically examined for potentially unsafe conditions such as: damaged cord, plug, housing, or parts, and that in the event such damage is found, the product should not be used until properly repaired. Never leave the fan outside in the rain or elements when not in use. Refer to the instructions for set-up, storage, maintenance and care.

Maintenance

- Product should be periodically examined for potentially unsafe conditions such as damaged cord, plug, housing, or parts, and that in the event such damage is found, the product should not be used until properly repaired.
- Product should never be stored wet. Allow to dry before rolling up.
- Surface washable only.

Disposal

- Disassemble and dispose of the equipment in such a manner that no hazardous conditions exist at the time the equipment is discarded.

Instructions for Fan Maintenance

- Product should be periodically examined for potentially unsafe conditions such as damaged cord, plug, housing, or parts, and that in the event such damage is found, the product should not be used until properly repaired.
- The fan does not require any lubrication and has no user serviceable parts. Do not attempt to service the fan.
- Do not immerse the fan in water. To clean, wipe with a damp cloth.
- Regularly check the intake and output openings and keep free of dirt, leaves, etc.
- When not in use, store the fan indoors in a dry place.
- Do not store outside when not in use.
- Store the fan upright on a stable surface.
- Loosely coil the cord and place it beside the fan.
- When in use, do not place the cord across traffic areas, water or damp areas.
- The fan is a high volume fan, and is capable of moving lots of air very quickly. Place the fan in an area where it will not suck in dirt or leaves.

Minimum Clearance Zones

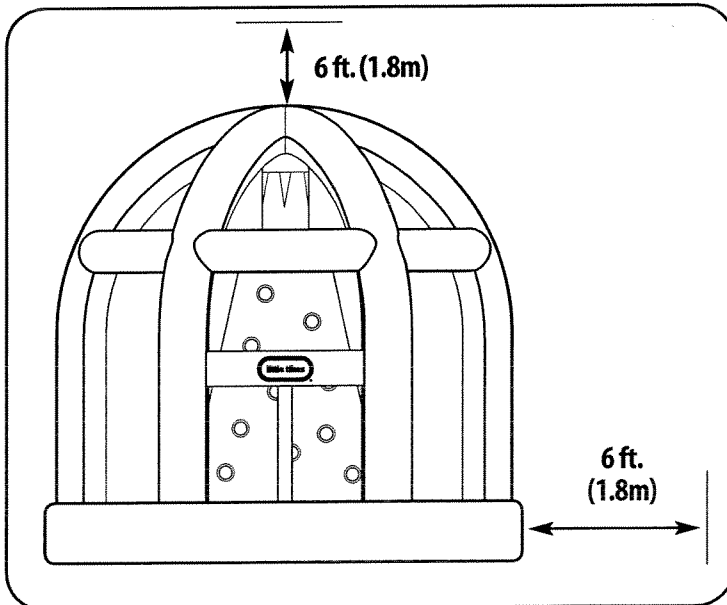

MINIMUM CLEARANCE ZONES

Make sure that there is a 6-foot obstacle-free zone around the product, including the slide and overhead.

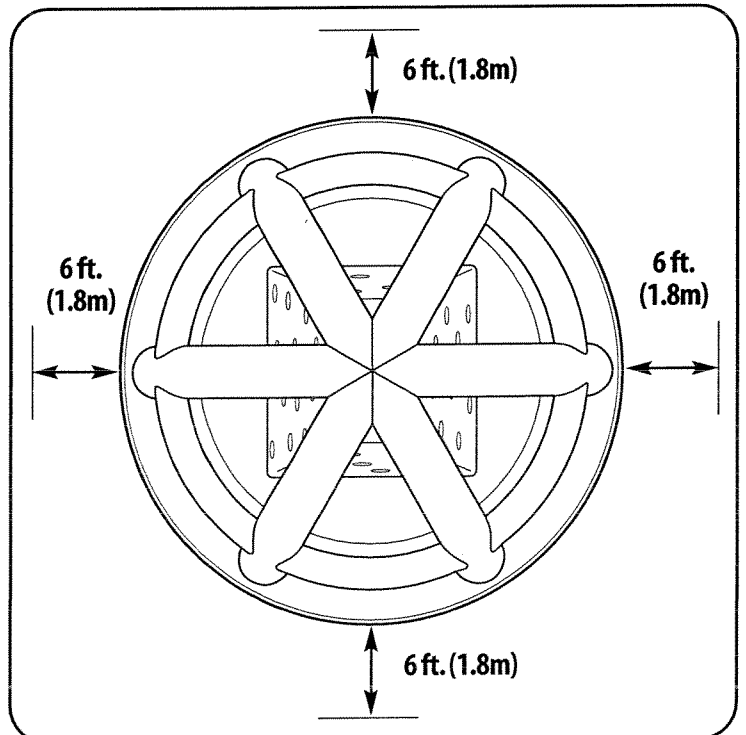

Set-up

1

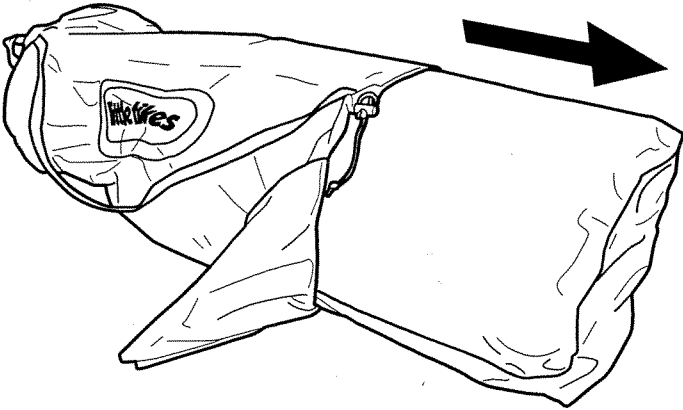

2

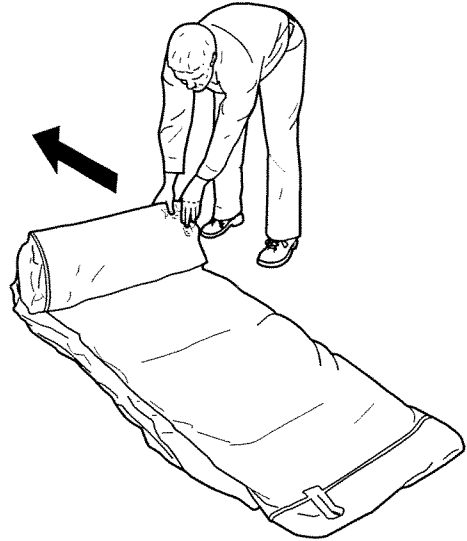

3

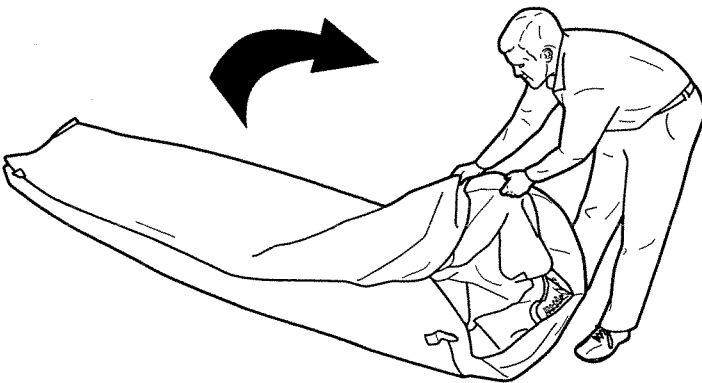

4



5

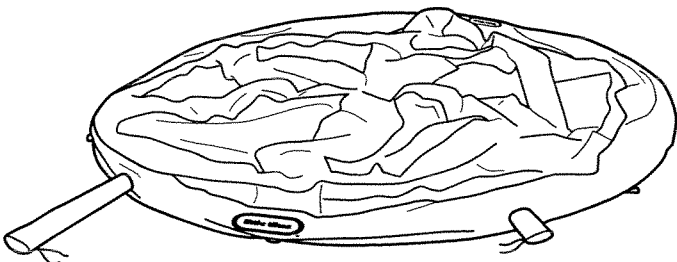

6

Attach blower unit to longer fabric tube making sure tube is not twisted.

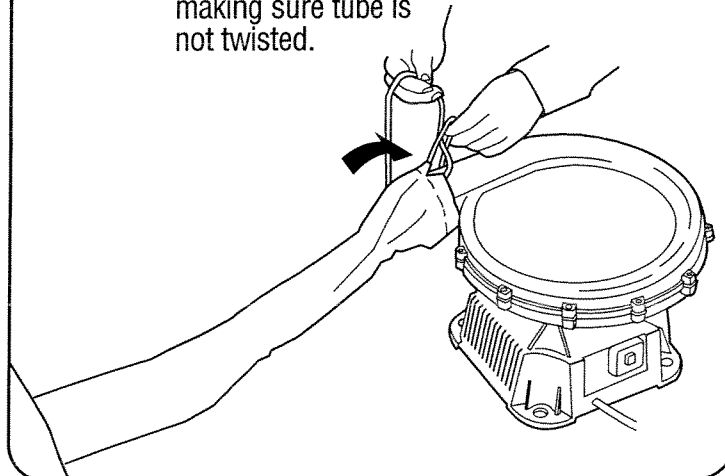

Set-up

7

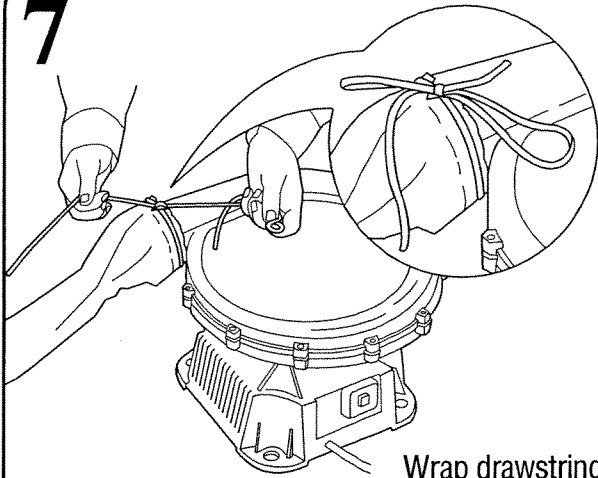

Wrap drawstring around tube and end of blower once, and tie tightly in place.

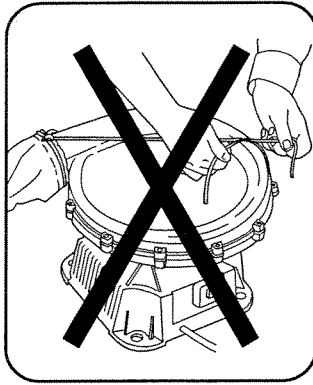

8

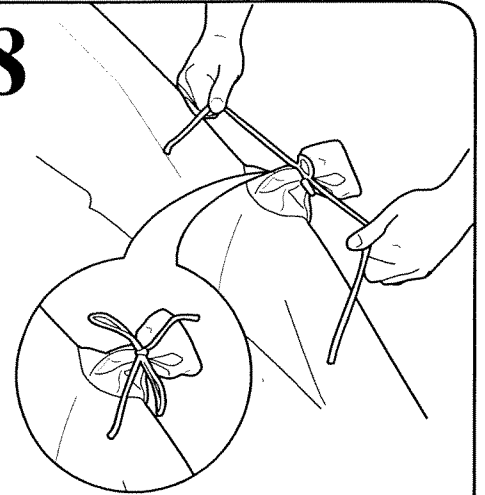

Repeat process on shorter fabric tube on other side.

9

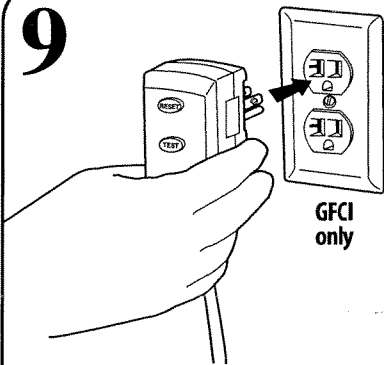

1. Plug GFCI into receptacle.
2. Press reset button.
3. Press test button.
4. Press reset button to use product. Do not use if the button fails to disable fan.

10

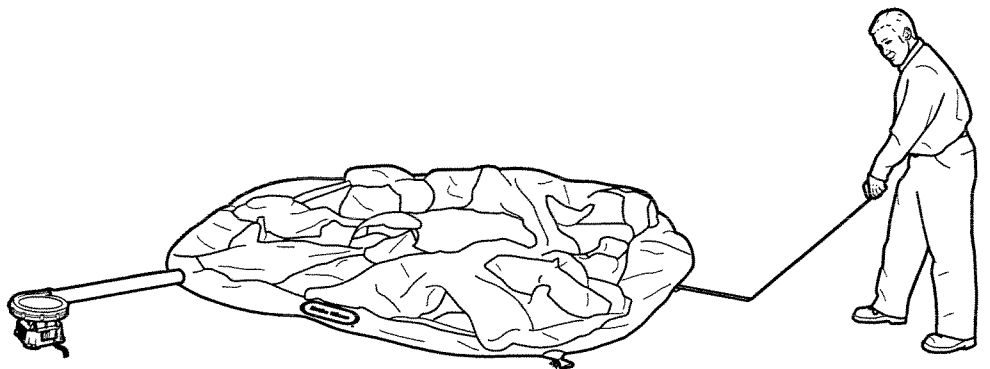
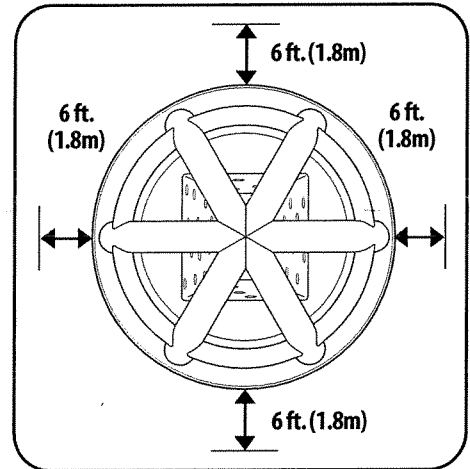
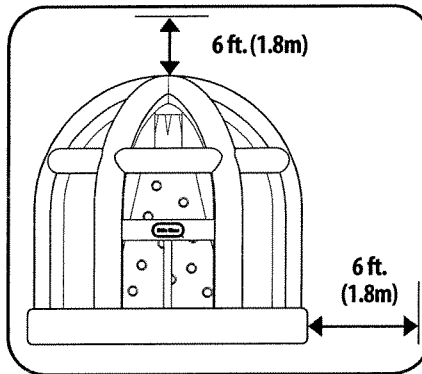

Re-measure minimum clearance zone prior to inflation.

Inflation & Staking

1

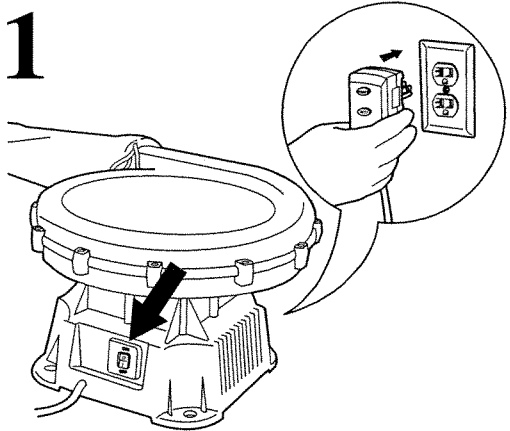

Switch power on. If blower does not operate when switched on, press reset button on GFCI adaptor.

2

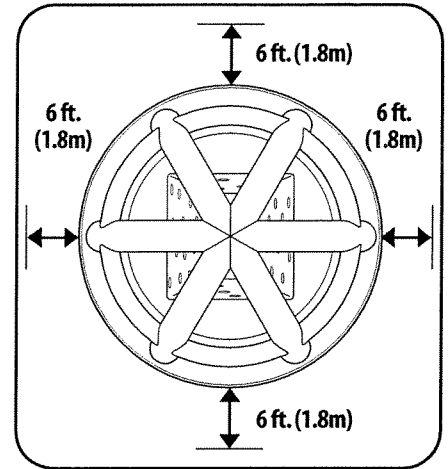
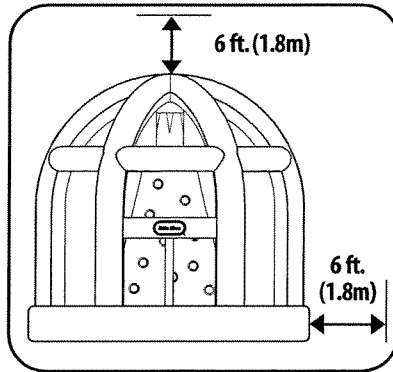

Blower should remain on and continuously inflate bouncer during use. Air flow through seams is normal. Do not try to seal or repair seams.

NOTE: Dispose of tissue paper packed inside bouncer after inflation.

3

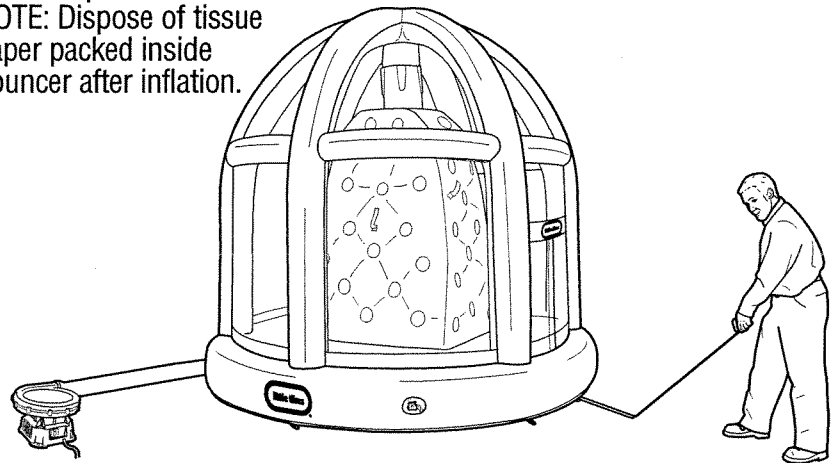
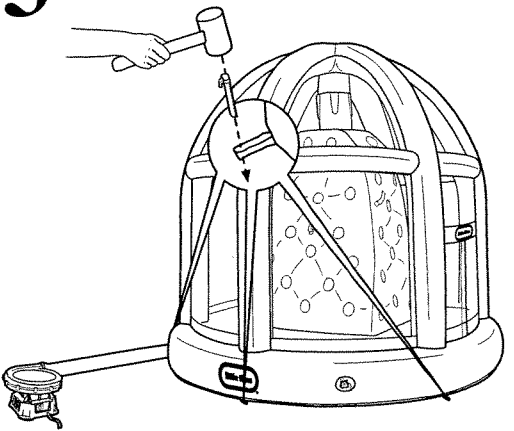

4

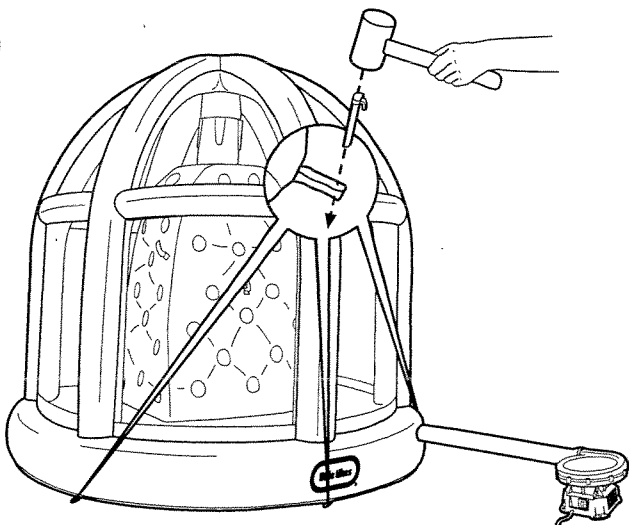

5

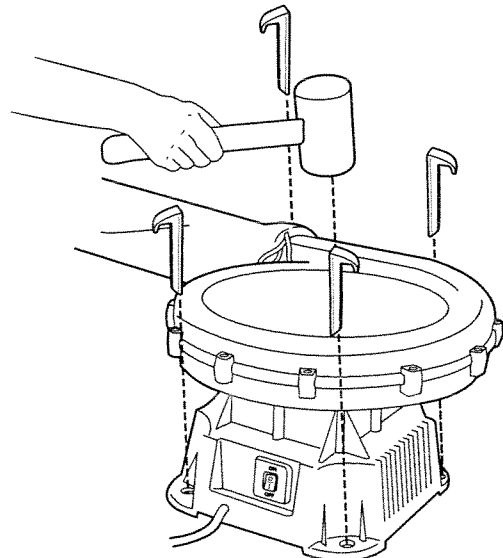

Climbing Patterns

There are four different ways to scale the rockwall, some more challenging than others. Follow this color-coded foothold guide to try them all:

Follow RED - challenge level 1 (difficult)

Follow YELLOW - challenge level 2 (moderately difficult)

Follow GREEN - challenge level 3 (moderately easy)

Follow BLUE - challenge level 4 (easy)

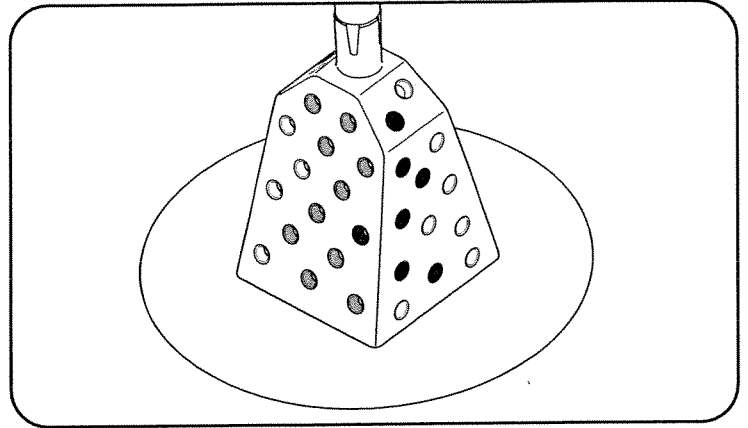

Deflation & Storage

1

Switch power off

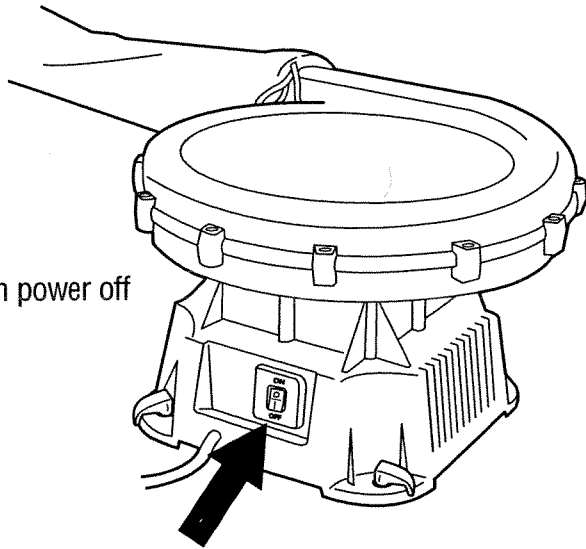

2

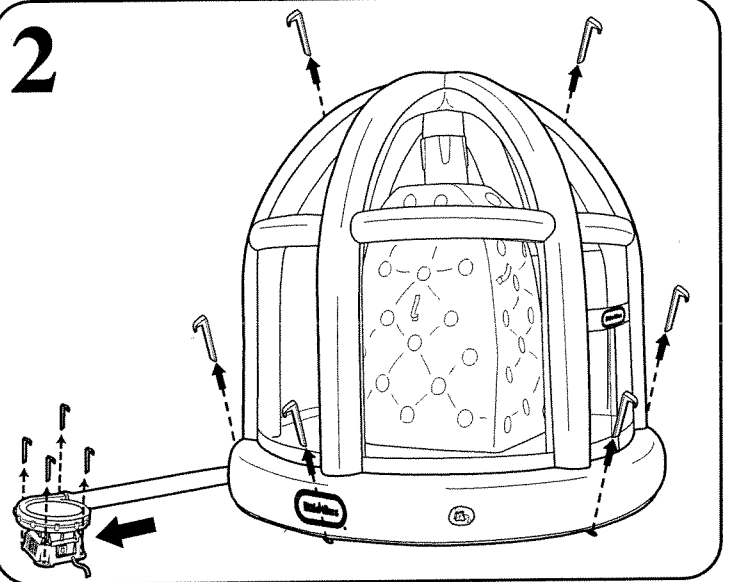

3

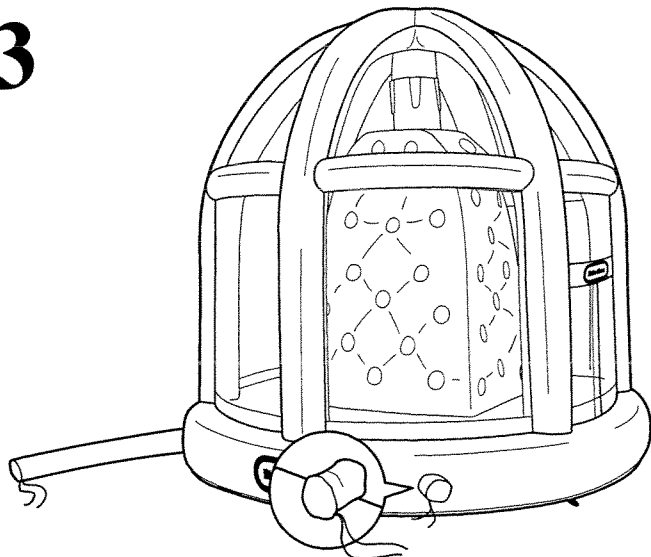

4

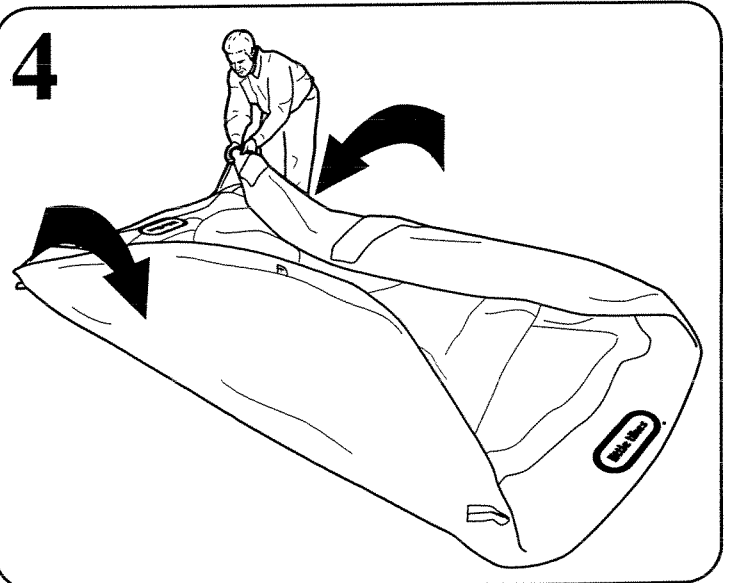

Deflation & Storage

5

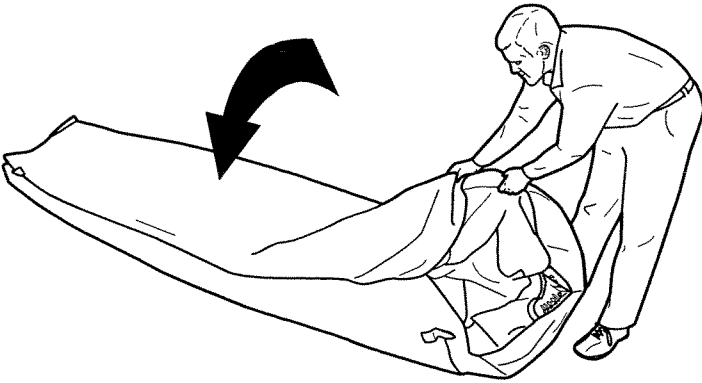

6

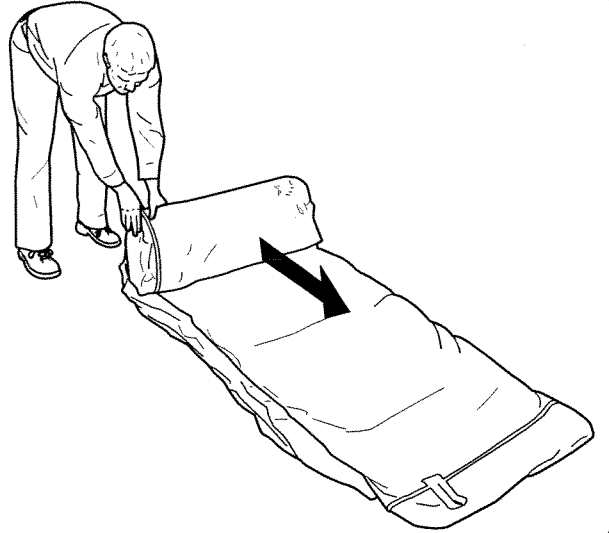

7

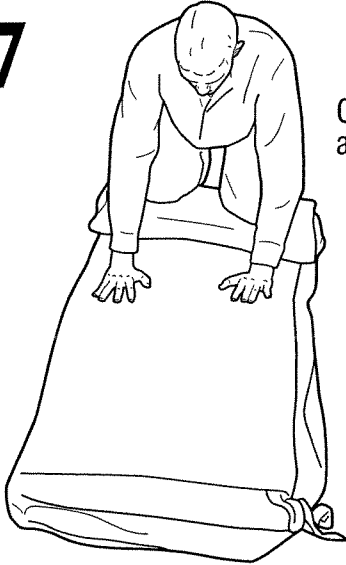

Compress air out as you are rolling up inflatable

8

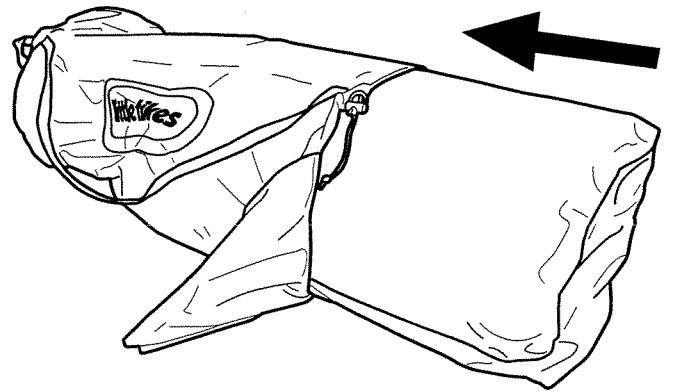

Repair Kit Instructions



WARNING: NOT A TOY. ADULT USE ONLY.
Repair kit. Keep away from children

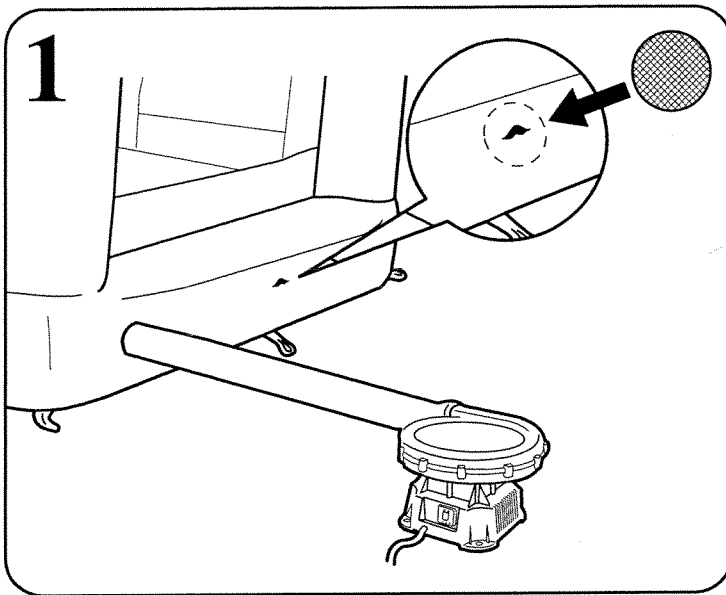

In the event of an accidental puncture, cut out a section of material that is larger than puncture (See figure 1).

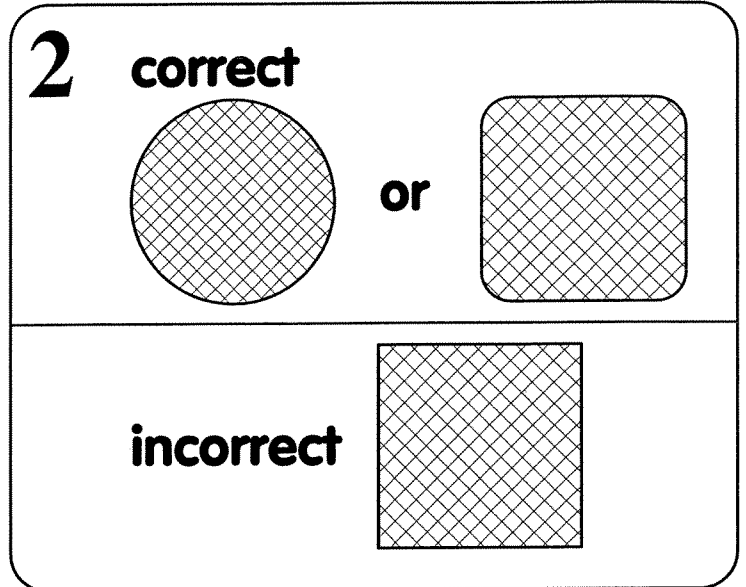

The material should be cut in circle or have rounded corners to prevent patch from peeling (See figure 2).

Make sure area is properly cleaned. Rubbing alcohol may be used to clean surface. Apply the glue to the back surface of the patch. Place patch over puncture and press firmly to obtain proper adhesion. Do not inflate the unit for at least 1 hour.

LIMITED WARRANTY

The Little Tikes Company makes fun, high quality toys. We warrant to the original purchaser that the fabric in this product is free of defects in materials or workmanship for 90 days from the date of purchase, and the blower is free of defects in materials or workmanship for one year* from the date of purchase (dated sales receipt is required for proof of purchase). At the sole election of The Little Tikes Company, the only remedies available under this warranty will be either replacement of the defective part of the product or refund the purchase price of the product. This warranty is valid only if the product has been assembled and maintained per the instructions. This warranty does not cover abuse, accident, cosmetic issues such as fading or scratches from normal wear, or any other cause not arising from defects in material and workmanship.

U.S.A and Canada: For warranty service or replacement part information, please visit our website at www.littletikes.com, call 1-800-321-0183 or write to: Consumer Service, The Little Tikes Company, 2180 Barlow Road, Hudson OH 44236, U.S.A. Some replacement parts may be available for purchase after warranty expires—contact us for details.

Outside U.S.A and Canada: Contact place of purchase for warranty service.

This warranty gives you specific legal rights, and you may also have other rights, which vary from state to state. Some states do not allow the exclusion or limitation of incidental or consequential damages, so the above limitation or exclusion may not apply to you.

*The warranty period is three (3) months for daycare or commercial purchasers.