

SPECIFICATION SUBMITTAL

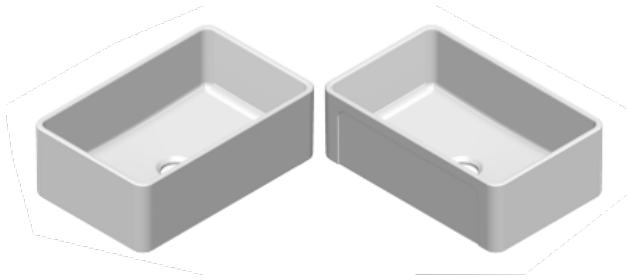

Kitchen Series

LTW3019W

Farmhouse Kitchen Sink

Finishes

	LTW3019W
White	X

Features

	LTW3019W
Reversible design	X
Fireclay material	X
White finish	X
Standard 3 1/2" drain opening	X
Compatible with waste disposal units	X
No extended flange needed	X
No overflow	X
3 year warranty	X

1-866-668-6690
1571 MAIN RD
NEWFIELD, NJ 08344

www.paini-usa.com



LTW3019W

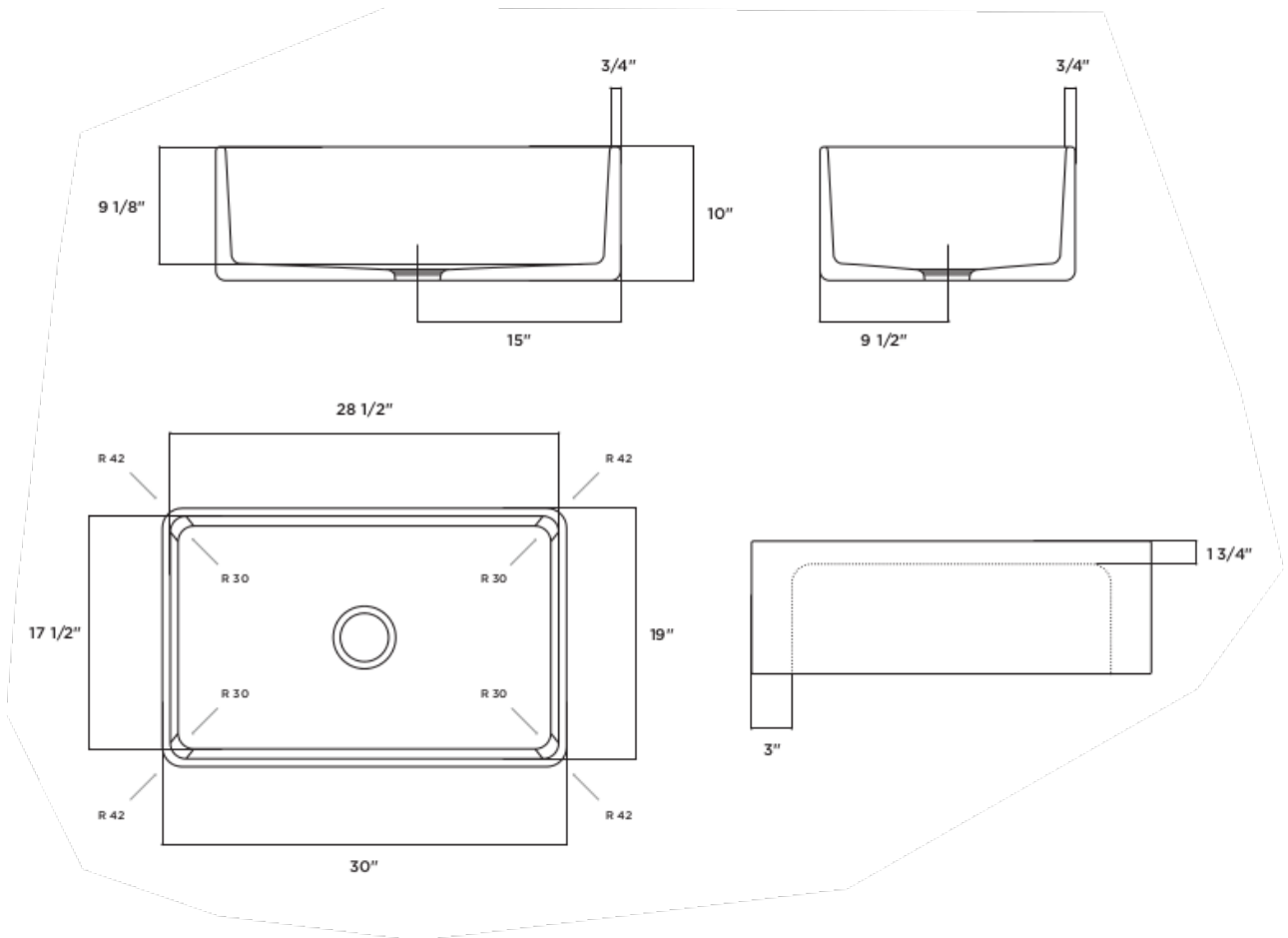

Farmhouse Reversible Fireclay Sink

30" x 19" x 10"

\$995.00