



INTRODUCTION

The Kinetic system is a complete foot, ankle system suitable for K2 level end users up to 350 lbs. The Kinetic prosthetic foot features a full-length flexible keel, integrated multi-axis ankle, and proximal adapter.

The SKF100, SKF103, SKF200, and SKF203 Kinetic systems also includes a 16" long modular pylon.

These products are designed to provide variable ankle stiffness, excellent ML compliance and plantar flexion in an aesthetically appealing Trulife Lightfoot cosmesis. The Kinetic system is available in sizes 22 to 30 cm with two color options and five bumper durometer selections.

The SKF200 /SKF203 Kinetic has a female proximal adapter while the SKF100/ SKF103/ SKF110/ SKF113 Kinetic Light has a male proximal adapter.

Product Code	Description	Patient Weight Limit
SKF100	Kinetic Light, Light Foot (includes AAA200 pylon)	160 kg / 350 lb
SKF103	Kinetic Light, Dark Foot (includes AAA200 pylon)	160 kg / 350 lb
SKF110	Kinetic Light, Light Foot (does not include pylon)	160 kg / 350 lb
SKF113	Kinetic Light, Dark Foot (does not include pylon)	160 kg / 350 lb
SKF200	Kinetic, Light Foot (includes AAA202 pylon)	160 kg / 350 lb
SKF203	Kinetic, Dark Foot (includes AAA202 pylon)	160 kg / 350 lb

INDICATIONS

The Kinetic and Kinetic Light are designed for lower extremity, K2 amputees that weigh (carried load included) according to the selection chart below.

Selection

To optimize selection, follow the three steps below to determine the appropriate category.

1. Locate the column associated with the amputee's foot length.
2. Locate the row corresponding to the amputee's weight.
3. The area where the column and row intersect lists the appropriate category.

 **If the amputee has a long BK or carries heavy loads, choose the next category higher.**

 **Choosing a lower strength category than what is suggested based on the above procedure and patient data will void the warranty and put your patient at risk. If your patient's weight exceeds the limits of the chart please call Trulife Customer Service.**



Patient Weight	Foot Length (cm)								
	22	23	24	25	26	27	28	29	30
137-160 kg 301-350 lb	-	-	-	-	5	5	5	5	5
101-136 kg 221-300 lb	-	-	4	4	4	4	4	4	4
81- 100 kg 177-220 lb	-	2	3	3	3	3	3	3	-
≤80 kg ≤176 lb	1	1	2	2	2	2	2	-	-

INSTALLATION AND USE

Recommended installation and use procedures must be followed for maximum safety and service life.

 **Failure to follow the installation and use procedures may lead to structural failure of the components subjecting the user to a risk of serious personal injury.**

 **Never modify the keel or structural ankle components.**

SKF200/ SKF203 Kinetic Installation:

1. Place the AAA202 male bonded pylon into the foot pyramid receiver and tighten the four set screws to maintain the appropriate alignment.
2. To maintain set screw tightness, remove the set screws individually and apply Loctite 242® removable thread locking compound to the threads of each set screw and replace.
3. Using a 4 mm hex head driver and torque wrench, tighten the set screws to 15 Nm (11 ft-lbs or 133 in-lbs).

 **The Kinetic female adapter uses GEOMET® coated set screws rather than the industry standard nickel plated or black oxide steel screws, which tend to rust in increased humidity. You may notice that the coated screws, which have the same torque requirements, have a different “feel” when tightening.**

- Use set screws supplied by Trulife. Use of unapproved fasteners will void the warranty and can lead to failure.
- Do not contaminate set screws with any type of paint, glue, or cement.
- Torque settings should be checked periodically. A loosely fastened bolt or set screw could lead to failure.

SKF100/ SKF103/ SKF110/ SKF113 Kinetic Light Foot Installation:

1. Connect proximal connecting components (pylon, clamp adapter, etc.) to the male proximal male pyramid feature of the foot as per typical modular component procedures.
2. Refer to the IFU's of the attached component for proper torque values and assembly procedures (typical set screw torque values for titanium and stainless steel 30mm female adapters are 15 Nm / 11 ft-lbs).



Alignment

The recommendations in this guide provide reliable starting points for static bench alignment.

- To establish anterior/ posterior placement of the foot, ensure the pyramid receiver is 13mm (1/2") posterior to the mid-line of the socket (Illustration 1).
- To establish medial/lateral placement of the foot, position the pyramid center 6mm (1/4") medial to the midline of the socket.

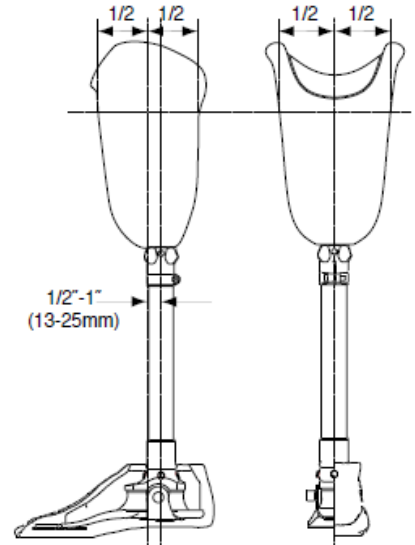

ILLUSTRATION 1

Maintenance

Replacement of the bumper is recommended once a year (less often for low activity amputees) to maintain optimum performance of the Kinetic and Kinetic Light. Refer to the selection chart located on page 1 of this install guide for the recommended replacement bumper.

Kinetic and Kinetic Light Maintenance Kits:

Product Code	Description	For use with:
SKF-KIT*	Kinetic Maintenance Tool Kit	All Kinetic Foot Models
SKF-REFURB-KIT-01	Kinetic Refurb Kit	All Kinetic Foot Models
SKF-BMP-1	Kinetic Soft Bumper	All Kinetic Foot Models
SKF-BMP-2	Kinetic Medium Bumper	All Kinetic Foot Models
SKF-BMP-3	Kinetic Firm Bumper	All Kinetic Foot Models
SKF-BMP-4	Kinetic X-Firm Bumper	All Kinetic Foot Models
SKF-BMP-5	Kinetic XX-Firm Bumper	All Kinetic Foot Models

*This kit is absolutely necessary for re-assembly of the Kinetic foot family. Without this tool, the axis shaft may not seat properly in the assembly leading to product failure.



BUMPER CHANGING AND REFURBISHING INSTRUCTIONS

Required Tools and Supplies:

SKF-KIT (*Figure 1*)

SKF-REFURB-KIT-01 (Kinetic Refurb Kit)

Additional Tools (*Figure 2*):

- 4 mm hex key (quantity of 2)
- Torque wrench with 4 mm hex driver
- Mallet
- Scrap piece of wood or plastic
- Arbor press or bar clamp (not pictured)

NOTE: The functional mechanisms of the Kinetic and Kinetic Light are the same, except that the Kinetic uses a female upper bracket component and the Kinetic Light uses a male upper bracket component.

Disassembly:

- Remove the two cosmetic plugs on either side of the foot.
- Using the two 4 mm hex wrenches, remove the button head screw and step washer from one side of the foot (*Figure 3*).
- Lightly tap the mallet on the head of the hex key to lightly tap out the shaft (*Figure 4*).
- Remove the internal components from the foot.



Figure 1: SKF-KIT

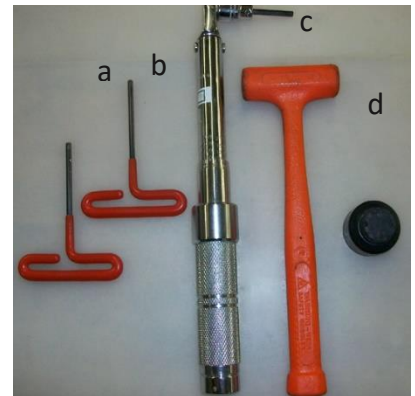

Figure 2: Additional Tools Required



Figure 3: Loosening the Shaft



Figure 4: The shaft Tapped Out

Assembly:

1. Coat the cylindrical part of the dorsi stop with white lithium grease, then insert it up through the distal pad and the bumper (*Figure 5A, 5B*).

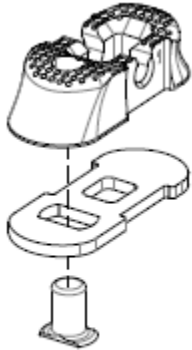

Figure 5A: Kinetic and Kinetic Light Dorsi stop inserted into pad spacer and bumper pad



Figure 5B: Dorsi stop inserted into pad spacer and bumper

2. Insert the bumper assembly into the foot cavity, then coat the spherical Delrin washers with white lithium grease and place them along the sides of the bumper (*Figure 6*). Orient the spherical surfaces of the washers so they are facing inward towards the bumper.



Figure 5: Insert Bumper Assembly

3. Use a hex wrench to loosely align the bumper and components. (*Figure 7*).

Lubricate proximal surfaces of bumper with white lithium grease

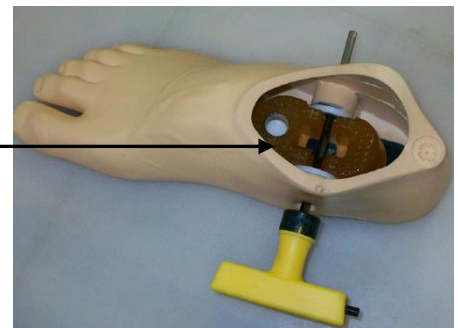

Figure 6: Loosely aligning internal components

4. Insert the hex shaft driver into the head of the shaft and thread the bullet onto the axis (*Figure 8A, 8B*).



Figure 7A: Insert hex shaft driver into shaft



Figure 8B: Shaft attached to hex shaft driver with bullet threaded

Note: If the foot is undergoing a refurbish procedure, the bushing will need to be pressed into the distal end of the upper bracket prior to the upper bracket being inserted into the foot cavity.

5. Place the upper bracket down on to the assembly through the cavity in the foot (*Figure 9A, 9B*)



Figure 9A: Upper bracket inserted into foot cavity



Figure 9B: Upper bracket inserted into foot cavity

6. Use the 4 mm hex wrench to generally align the holes of the assembly.
7. Compress the assembly with an arbor press or bar clamp until the holes appear to be aligned. Use a scrap piece of wood or plastic to prevent scratching the surface of the upper bracket (*Figure 10*).



Figure 10: Upper bracket being compressed

8. Lightly lubricate the bullet and axis with a coat of white lithium grease. With the assembly compressed, push the axis assembly through the ankle joint (*Figure 11A, 11B*), until the bullet begins to protrude from the opposite side. A light tap with a mallet might be necessary while maintaining a compressive force on the assembly.

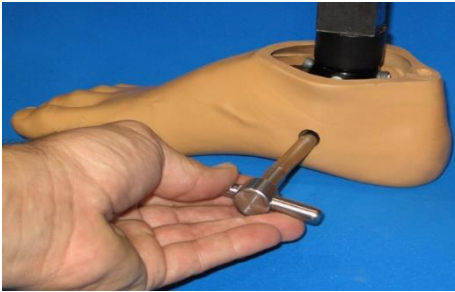

Figure 18A: Pushing the axis assembly through the ankle joint



Figure 11B: Pushing the axis assembly through the ankle joint

9. Place the tip of the protruding bullet into the shaft guide (*Figure 12*), and use your arbor press or bar clamp to drive the axis all the way until it is seated through the far side of the internal stirrup (*Figure 13A, 13B*).

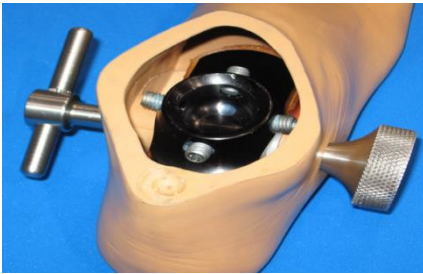

Figure 92: Bullet inserted into shaft guide

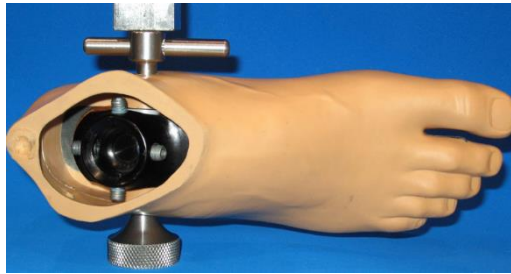

Figure 13A: Fully seating the axis



Figure 103B: Fully seating the axis

10. Remove the bullet from the axis.

⚠ The bullet should back out easily. If it doesn't, then the shaft was not pressed completely through the assembly. Repeat step 9 if necessary.

11. Install the M6 button head screw and washer into the axis. Use Loctite 242 on the threads (*Figure 14*).

⚠ Ensure that the recess feature of the washer is oriented inward, towards the foot.

12. Use a 4 mm hex wrench to hold the shaft and use a torque wrench to tighten the button head cap screw to 8 Nm (6 ft-lb).



Figure 11: Installing the screw and washer

13. Insert the cosmetic plugs back into the foot.

STORAGE AND USE

There are no identified restrictions on the temperature of storage and use.

DISPOSAL

There are no hazardous materials in the device. Comply with local and national laws and regulations.

LEGAL INFORMATION

MD The use of this class 1 medical device is subject to the respective national laws of the country of use and may vary accordingly. The user of this device should report any serious incident to Trulife and the competent authority of the country of use.



Trulife

3225 Woburn St. Suite 160
Bellingham, WA 98226
USA

Phone (+1) 360 697 5656

Email supportop@trulife.com



MDSS GmbH

Schiffgraben 41
30175 Hannover
Germany

LIMITED WARRANTY

Trulife warrants that the PRODUCT will be free from defects in material and workmanship from the date of installation for the warranty period stated on the PRODUCT warranty card.

This warranty will not apply if the PRODUCT has been damaged by misuse, abuse, neglect, improper care, failure to follow instructions, abnormal wear and tear, or in the event that the PRODUCT has been modified/repared by persons unauthorized by Trulife.

If a defect in material or workmanship is found during the warranty period, Trulife will, at Trulife's option, either repair or replace the product. If it is not possible to repair or replace the product, Trulife will be limited to refunding the purchase price.

Trulife will not be liable under any legal theory for any direct, indirect, special, incidental or consequential damages arising from the use of or inability to use this product.

The application guidelines for this Trulife product are for the use of and by a certified, qualified practitioner only. Patients are not to attempt to apply or adjust the item unless expressly instructed to do so by the practitioner responsible for the prescription and/or initial fitting of the device. All patient questions should be referred to the practitioner and not to the manufacturer. The manufacturer warrants only that the enclosed product has been inspected for quality and can be effective for certain indications, but final decisions and ongoing monitoring must be made by the medical professional(s) prescribing and/or fitting the device to determine its effectiveness for an individual patient. Patient compliance is an integral part of the entire protocol and must be adhered to in order to avoid potential problems and to maximize the effectiveness of the prescribed product.



As a condition of the sale of any Trulife product, this product is restricted to a "Single Patient Use Only" by the originally fitted patient in order to protect the care provider and the patient against potentially adverse consequences of infectious disease transmission, material instability in adapting to the configuration of the original user and/or decrease in effectivity. Any express or implied warranties are voided if the product is reused or fitted to another patient. Additionally, a license of right to use under any relevant patents pertaining to the product is terminated with the cessation of use by the original patient. As with all Trulife products, this product must be prescribed and applied by a qualified practitioner to determine it meets the needs of the particular patient and accomplishes the desired results.