

NCASE

M1 Classic Configuration

Flatpack Assembly Manual

Flatpack Assembly Manual

CAUTION: do NOT overtighten screws. Once resistance is encountered, do not tighten more than one-quarter turn. Each fastener is different in length or head-shape, and putting them next to each other is an excellent way to identify them.

Screw-5

M3 Flat Sunk Screw

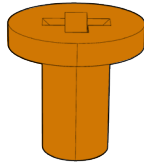

ThumbScrew-10

M3 Thumb Screw

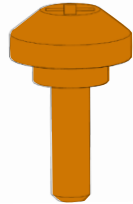

Standoff-6

M3 Female Standoff Screw



CScrew-8

M3 Countersunk Screw

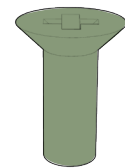

Flatpack Assembly Manual

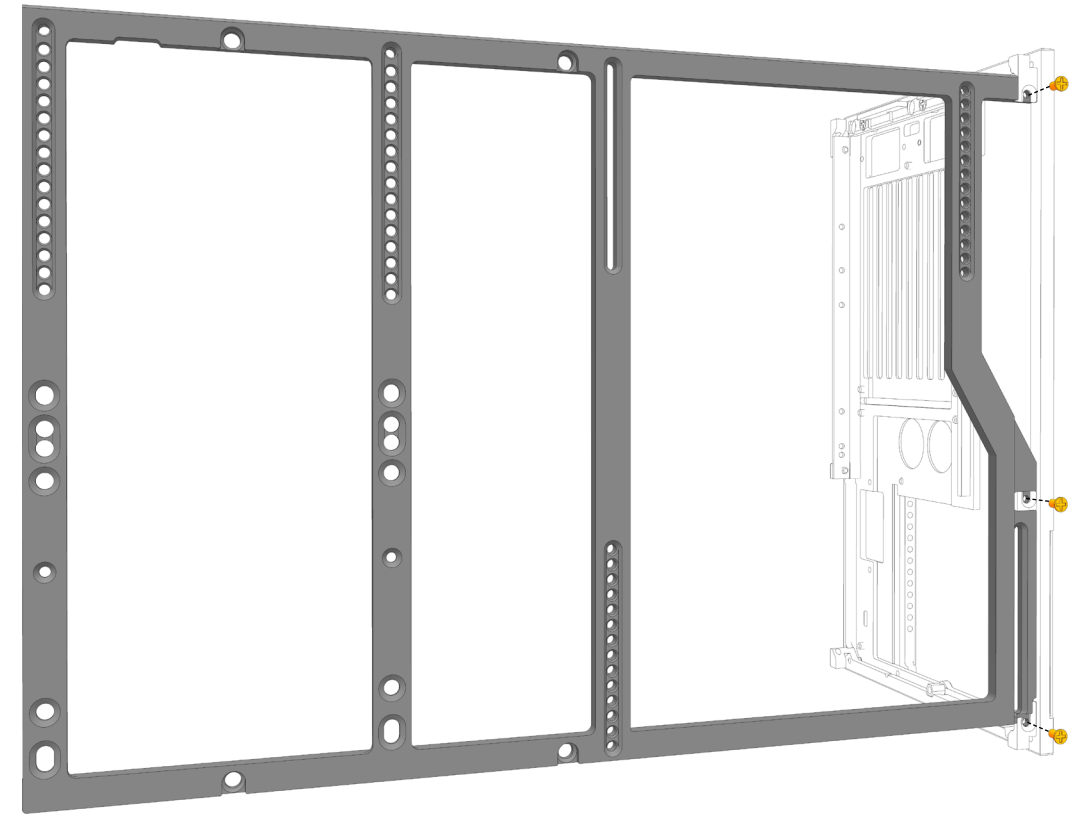

M3-FS-5

Flatpack Assembly Manual

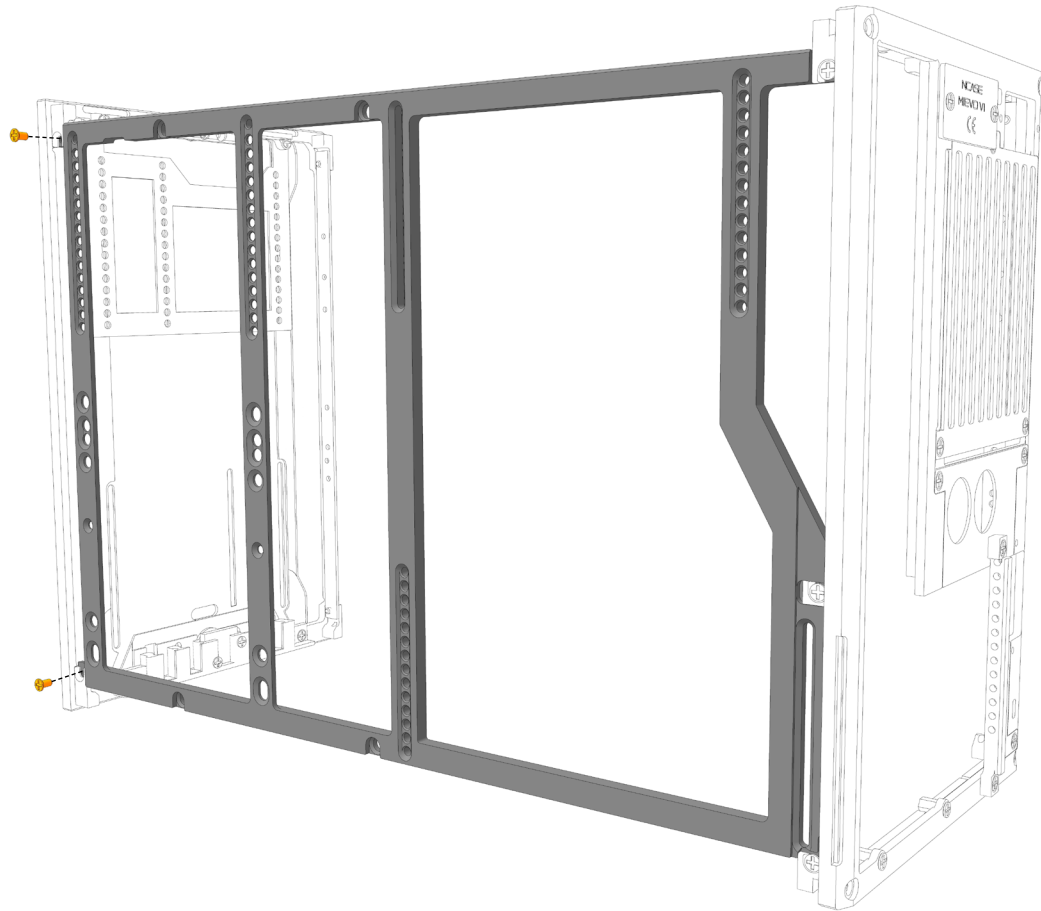

M3-FS-5

Flatpack Assembly Manual

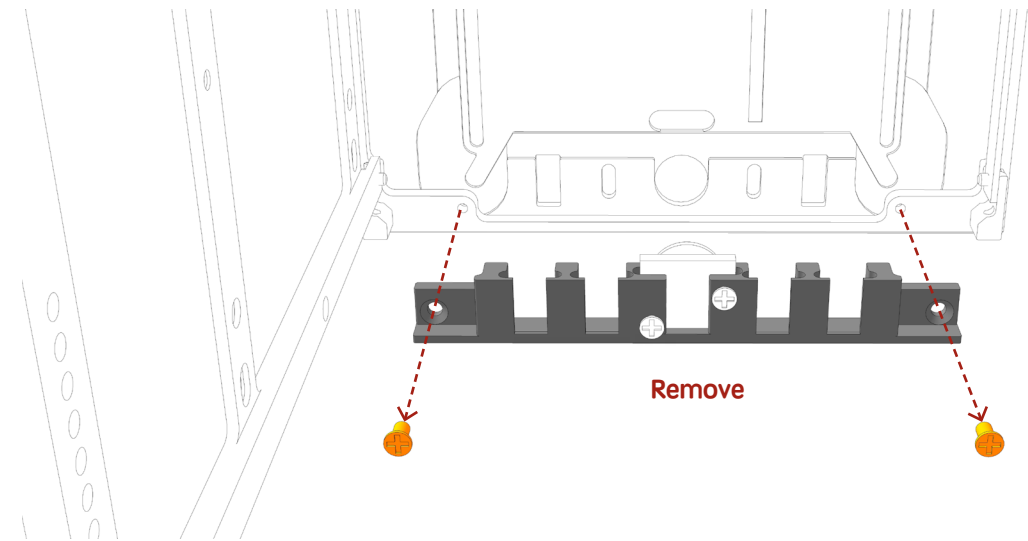

Remove

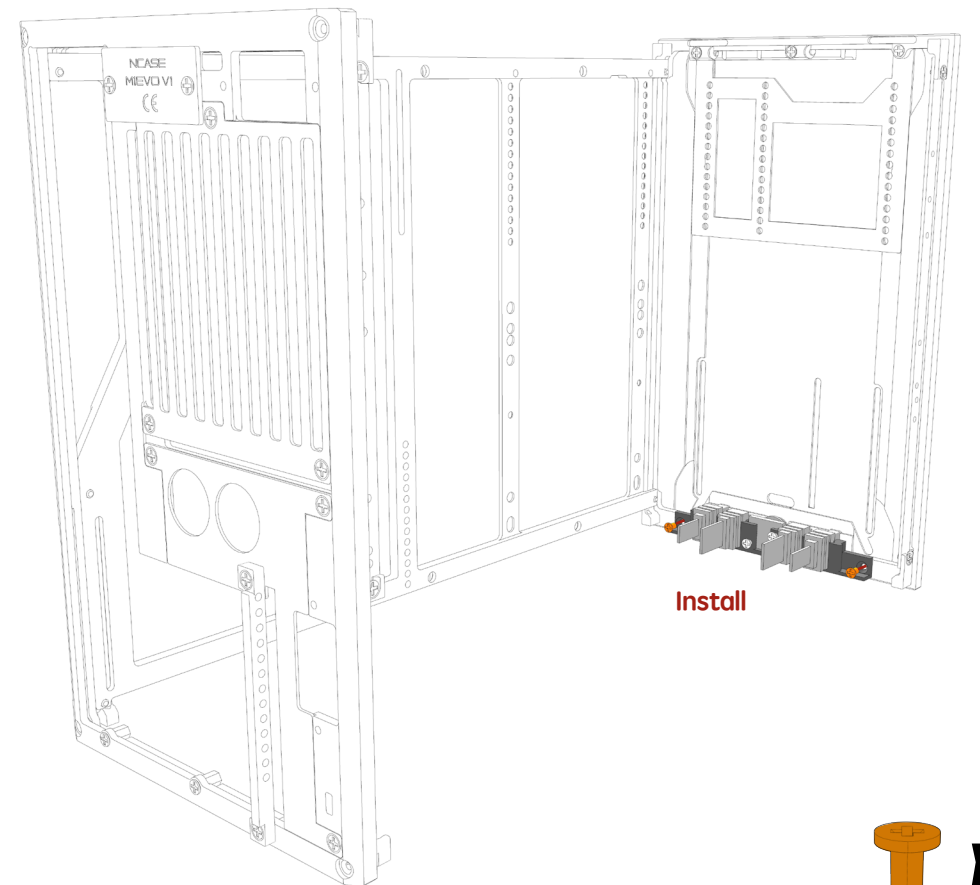

Install



M3-FS-5

Flatpack Assembly Manual



X4

M3-FS-5

Flatpack Assembly Manual

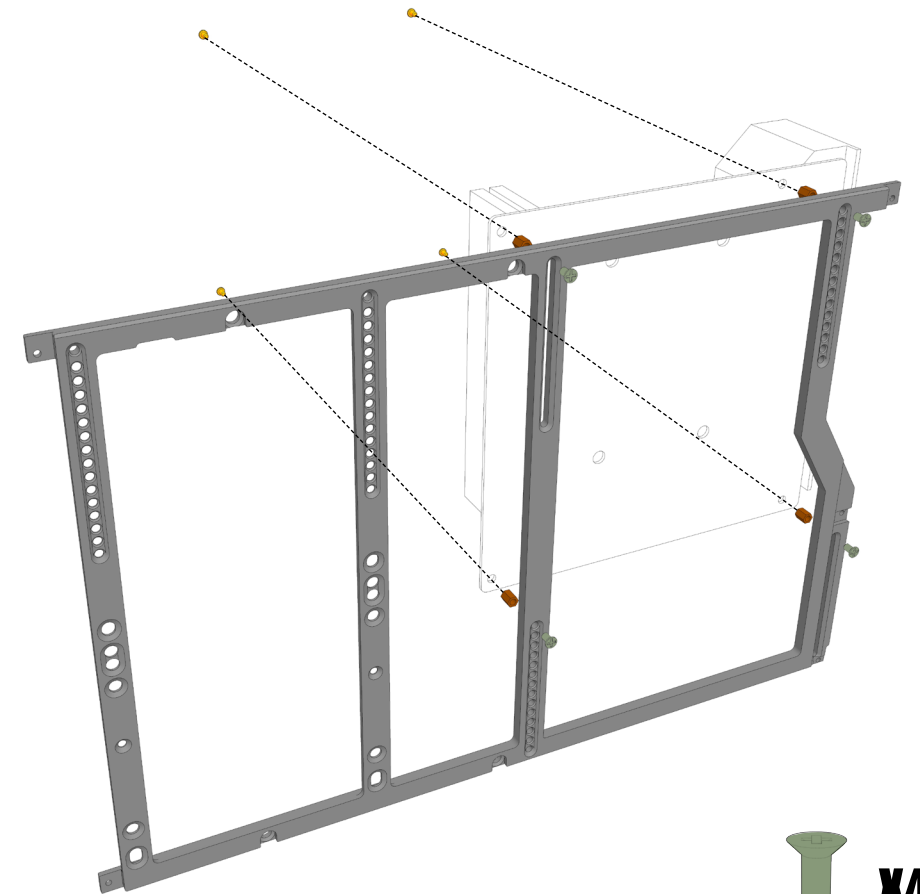

X4

M3-CS-8



X4

M3-FSS-6



X4

M3-FS-5

Flatpack Assembly Manual

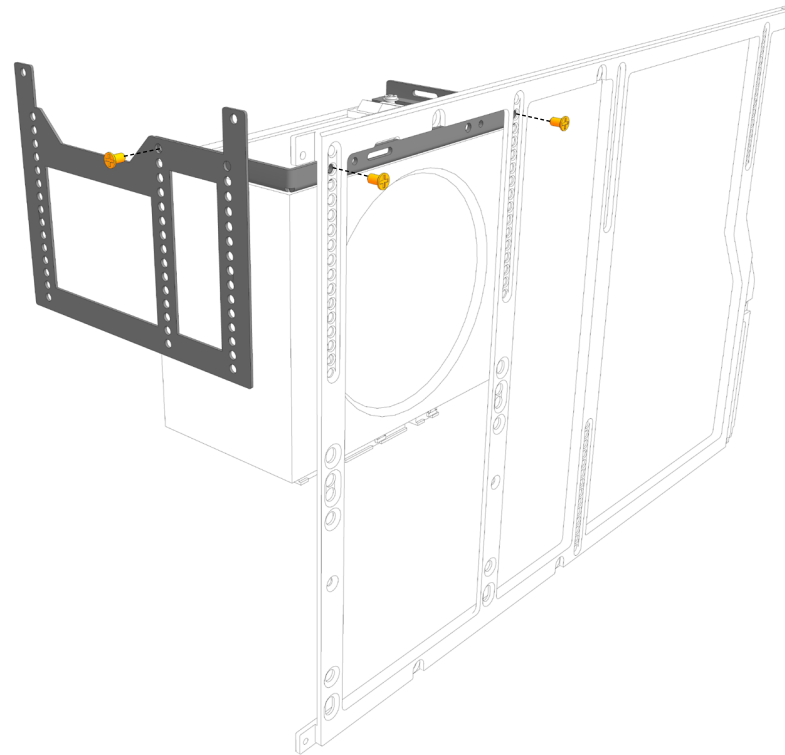

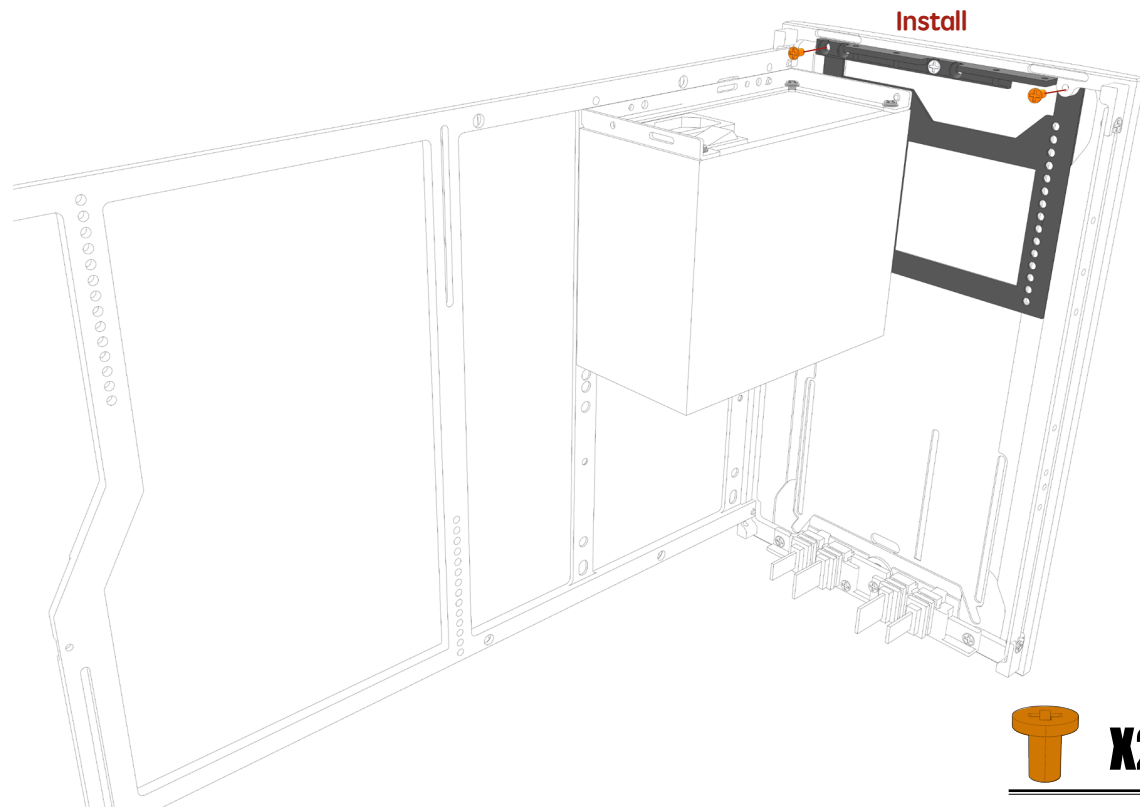

 **X3**
M3-FS-5



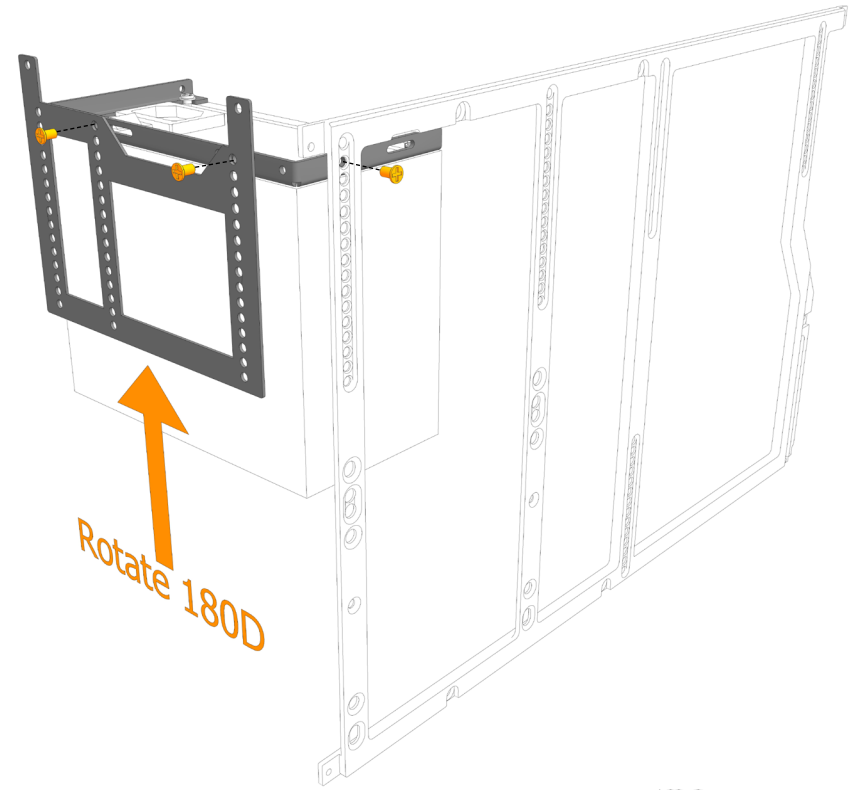

 **X2**
M3-FS-5

Flatpack Assembly Manual



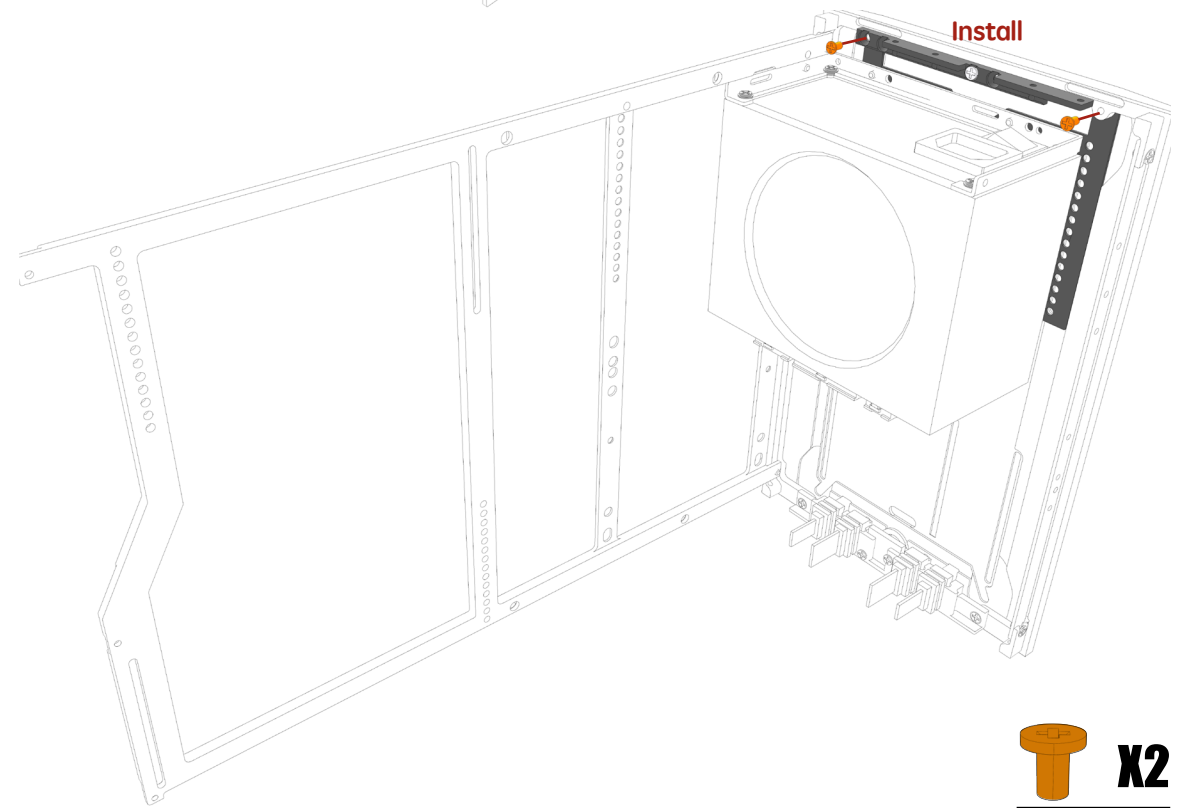

 **X3**
M3-FS-5

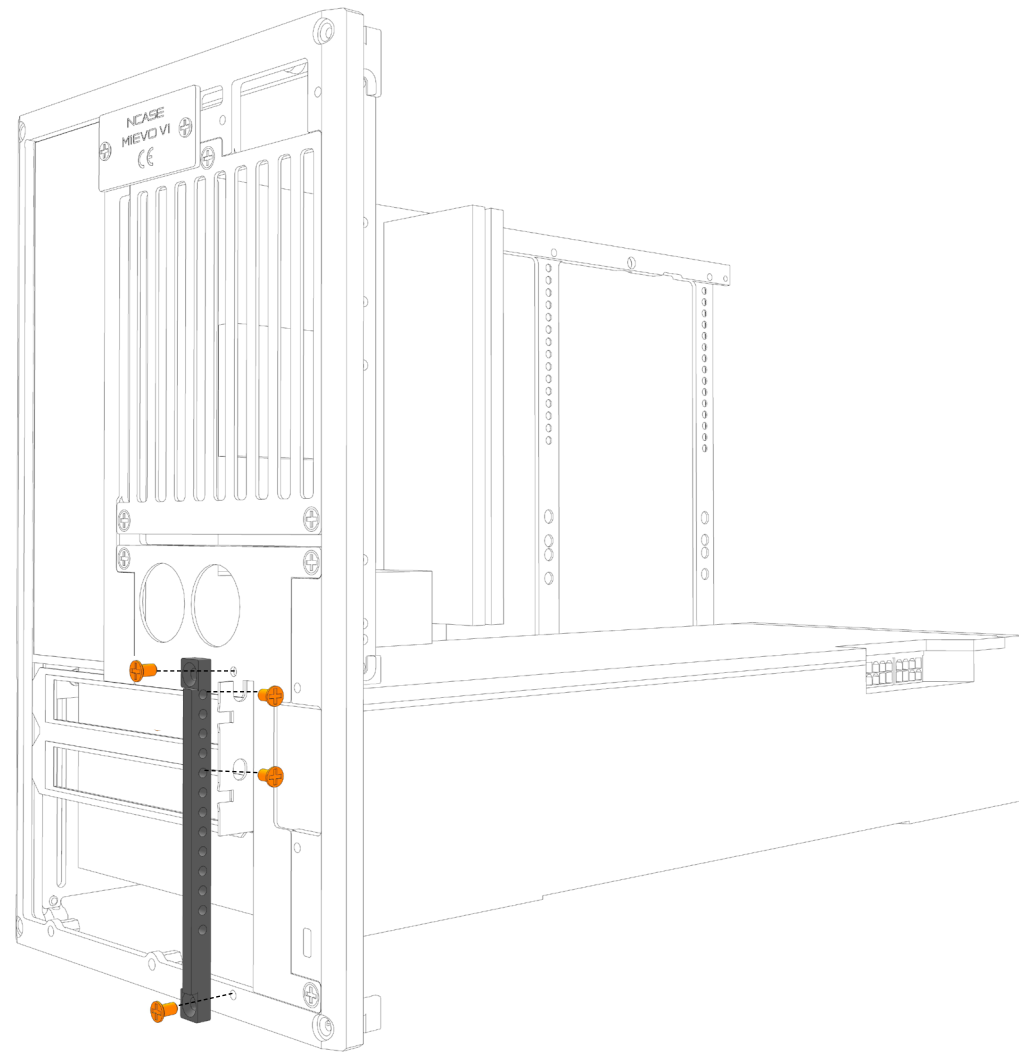

 **X2**
M3-FS-5

Flatpack Assembly Manual



 **X4**
M3-FS-5

Flatpack Assembly Manual

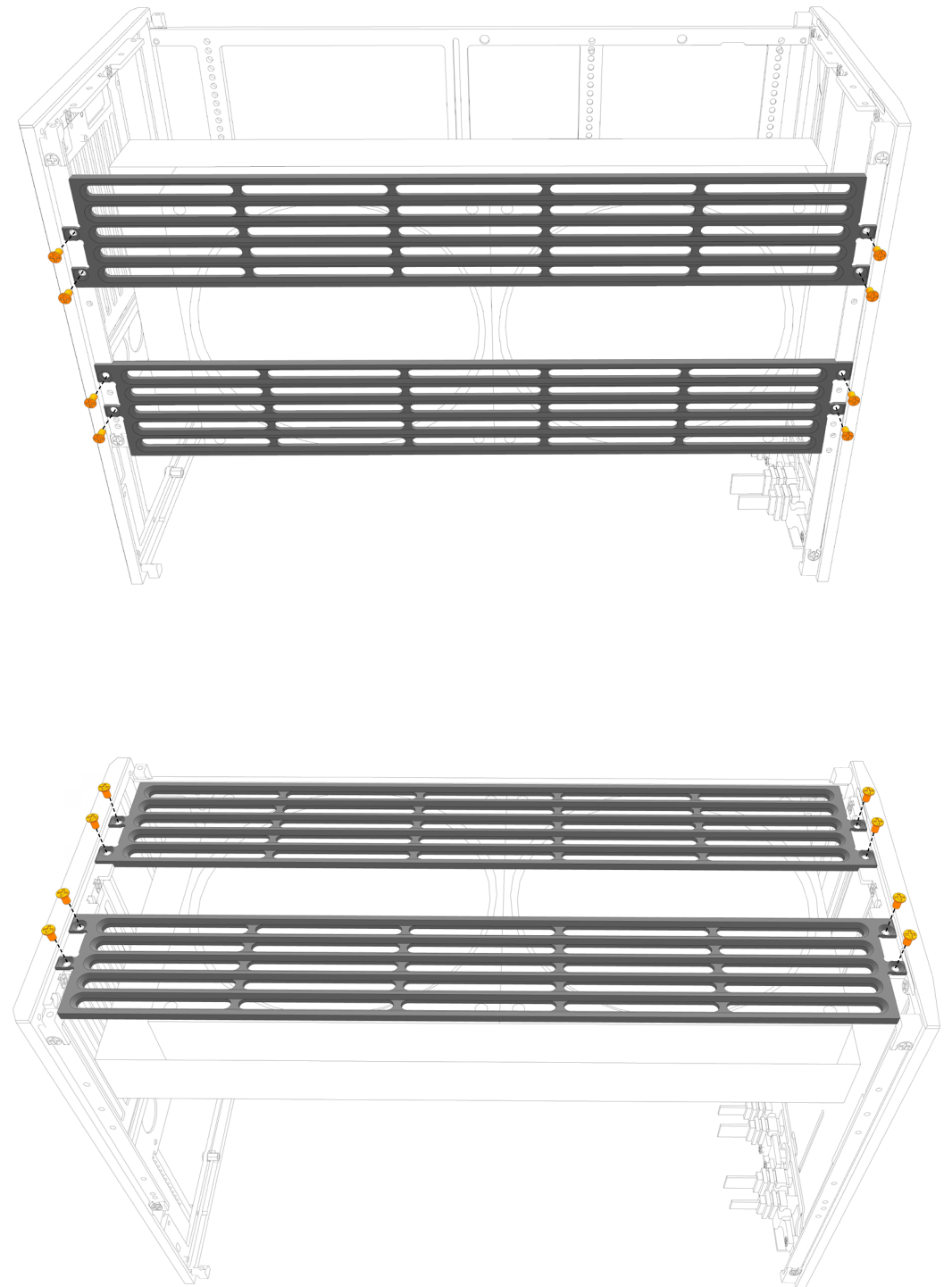

 **X8**
M3-FS-5

Flatpack Assembly Manual

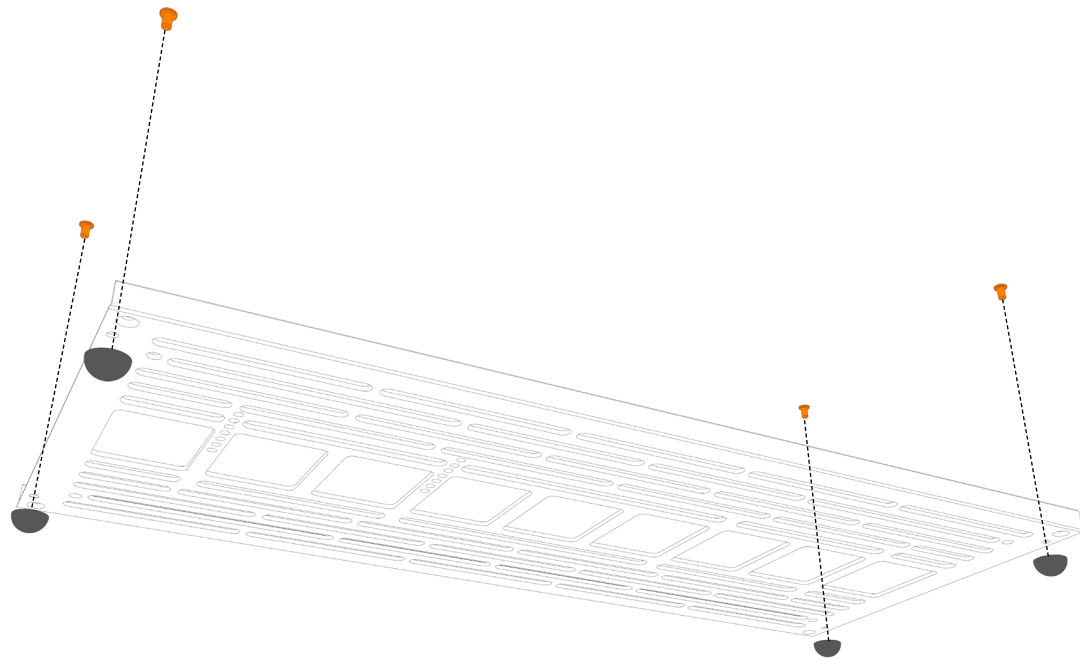

 **X4**
M3-FS-5

Flatpack Assembly Manual

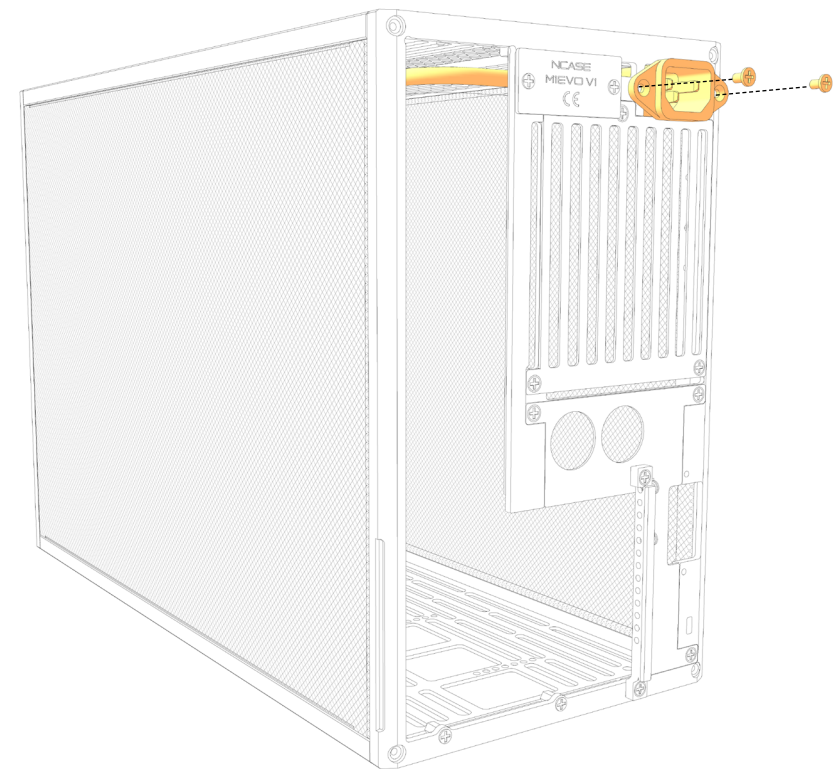
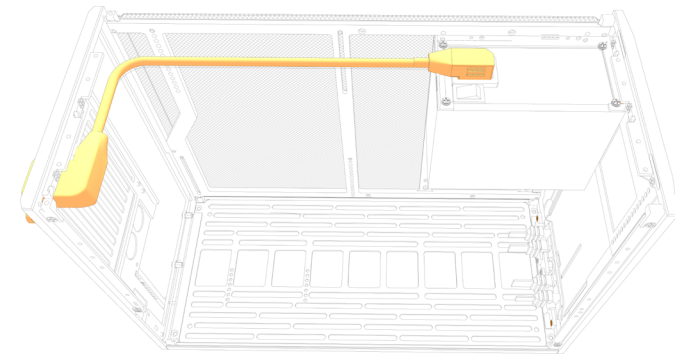
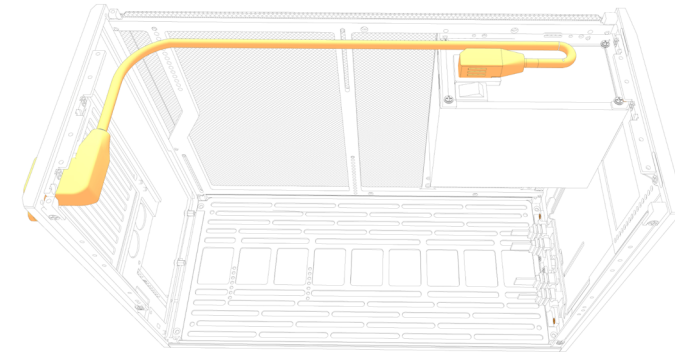

 **X2**
M3-FS-5

Flatpack Assembly Manual

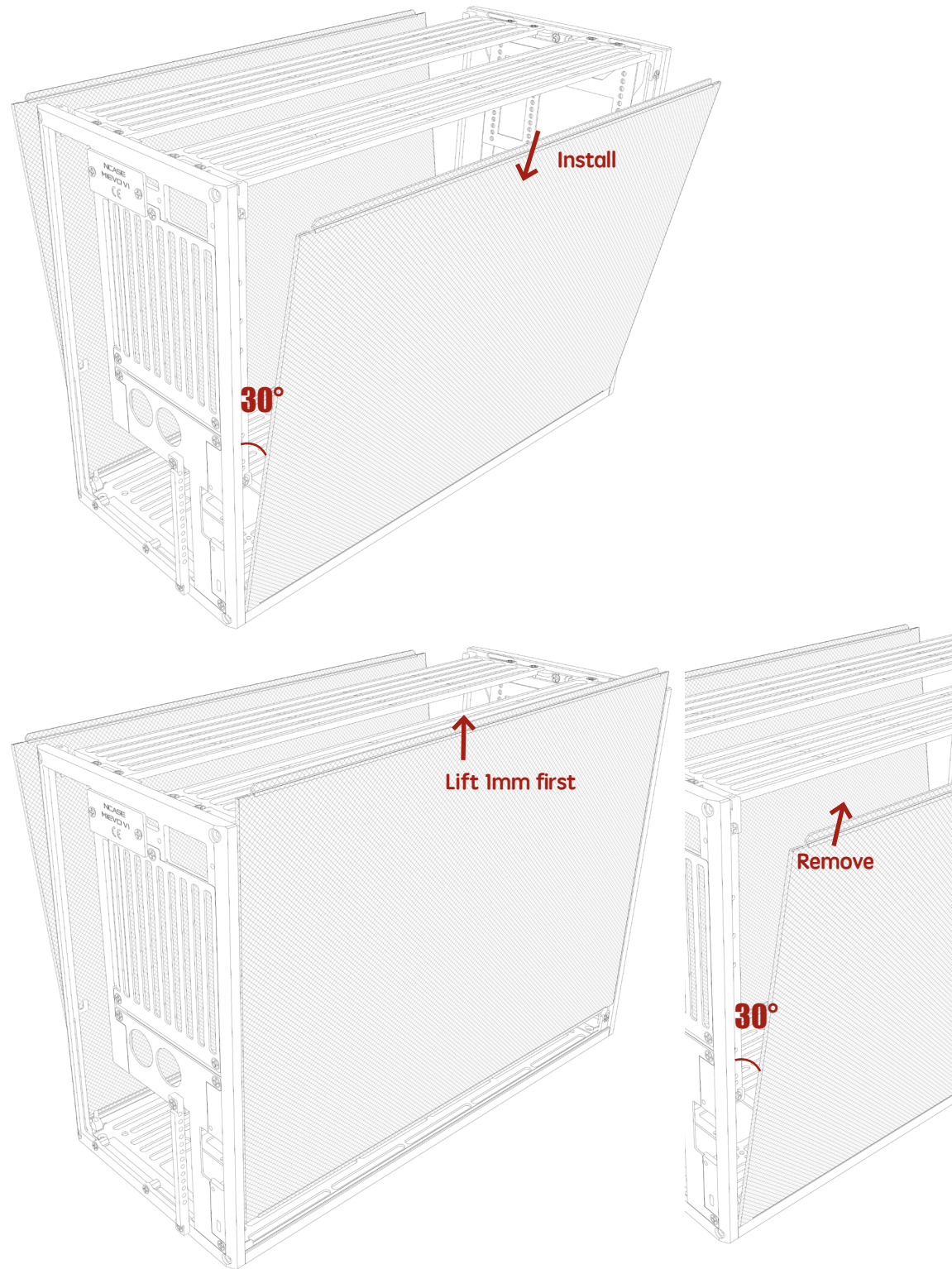

Flatpack Assembly Manual

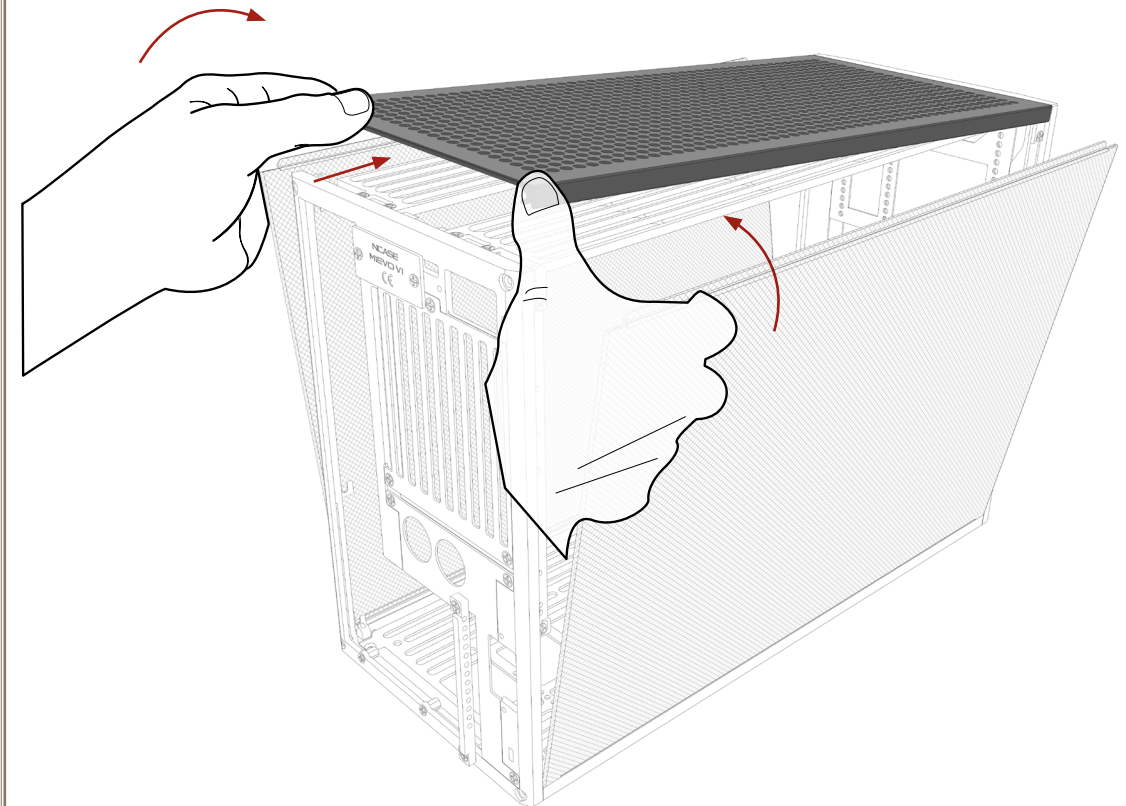

Flatpack Assembly Manual

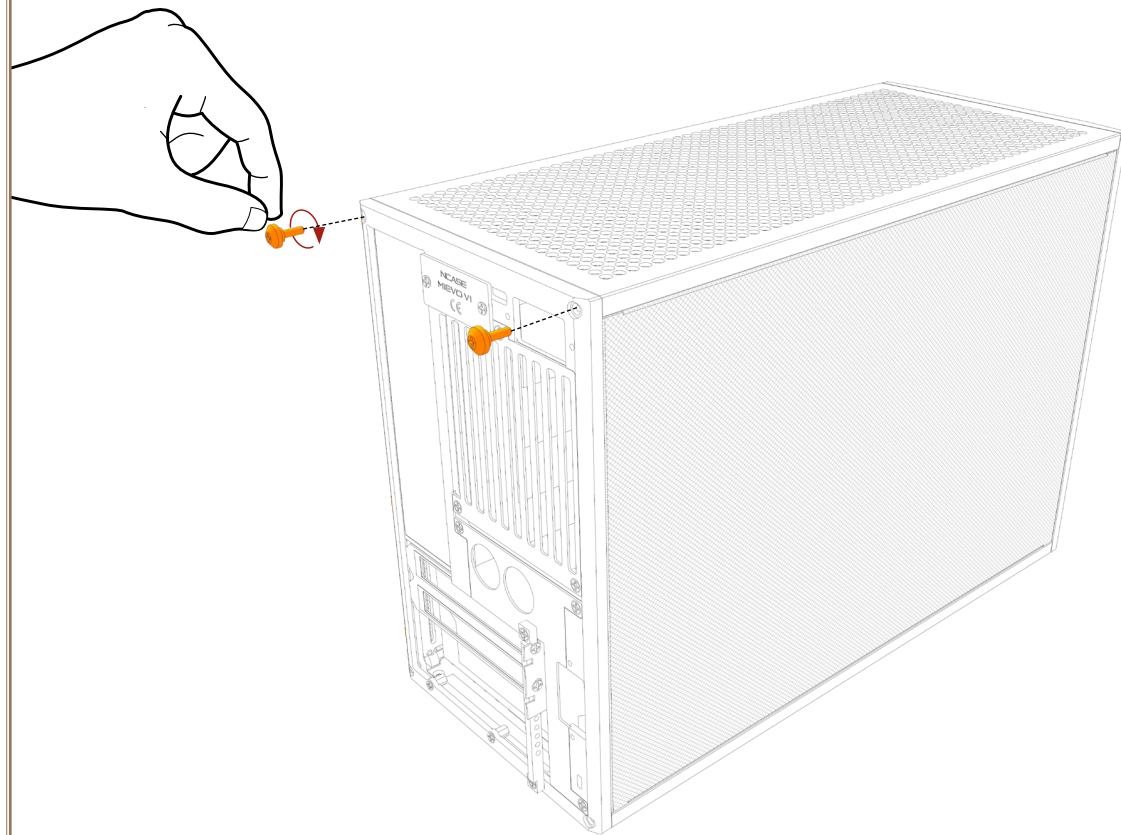

NCASE

**M1 Classic
Configuration**



M3-TB-10