

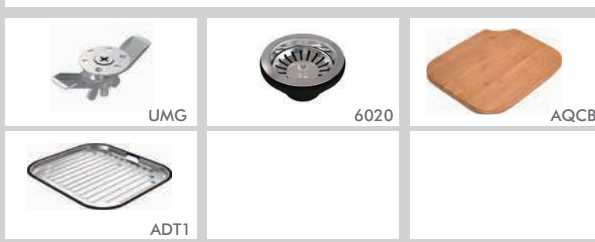

Model Code: Q100U

Included Accessories



Optional Accessories

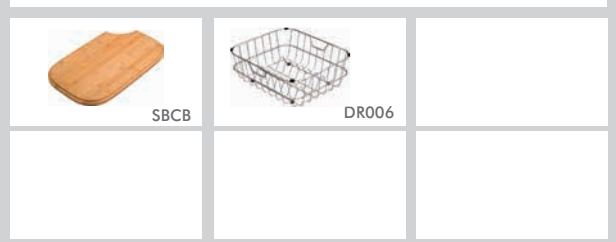

Dimensions

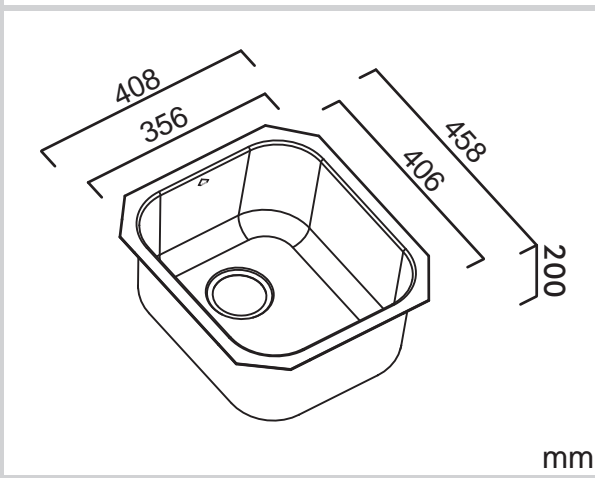

Specifications

Description	Single bowl, undermount sink
Overall Sink Size	408mm x 458mm x 200mm deep
Bowl Dimensions	356mm x 406mm x 200mm deep
Drainer Length	
Technic	N/A
Material	Press Stainless steel SUS304

Installation

Fixings	Undermount clips supplied
Template	Supplied
Min Cabinet Size	500mm
Waste Holes	1 x 90mm round Compatible with waste disposal

SURFACE FINISH



WASTE KIT

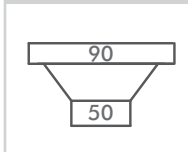

MATERIAL

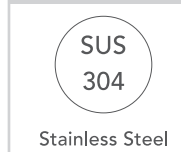

Plumbing

Waste Fittings	1 x (90mm x 2") basket waste included
Overflow	Available, conditions apply

INSTALLATION OPTIONS

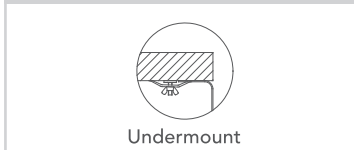

PROFILE

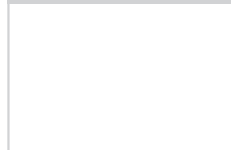

Packaging

Carton Type	EPS protection & individual carton
Gross Weight	7.61Kg
Carton Size	535mm x 505mm x 285mm
Pack QTY	1

Abey are Australia's leaders in sinkware, designing and manufacturing to the world's highest quality specifications as well as sourcing and bringing you Europe's very best, leading edge designs – practical, affordable, inspirational, stylish, timeless or cutting edge. When you buy an Abey stainless steel sink you receive the highest quality and 25 year warranty. Abey and the manufacturer are continually seeking ways to improve the design specifications, aesthetic and production techniques of the products. As a result, alterations to the specifications and dimensions of the products and designs occur continually.