

MYTHOS

MYX210-70FPC

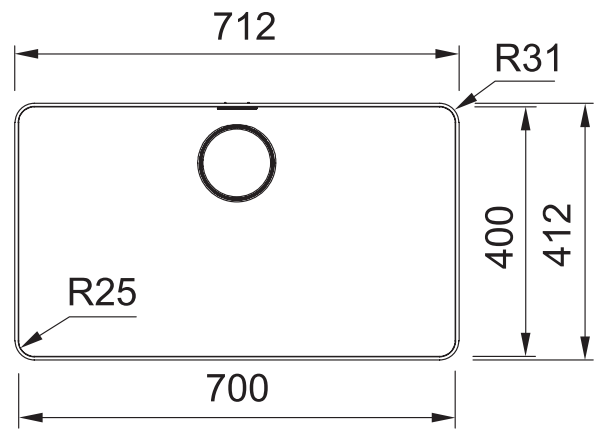

PRODUCT INFORMATION

Installation	Topmount/Flushmount
Dimensions	712 x 412mm
Cabinet Base	800mm
Bowl Size	700 x 400 x 200mm/56L
Bowl Radius	25mm
Cut-Out Size	See Installation Document
Cut-Out Template	No
Waste Outlet	Semi Integrated Waste
Overflow	Yes
Tap Holes	No
Remote Waste	Yes (35mm hole required in benchtop)
Finish	Stainless Steel
Warranty	50 Years

ACCESSORIES

— Included Accessory
- - - Available Accessory

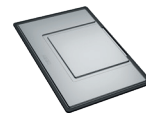

DT288
Extension Drainer



RM081
Rollamat



PB835
Push Button Waste



CBP082
Chopping Board



SB398
Strainer Bowl

NOTE: Cut-out dimensions are a guide only, please use the actual sink as your template.

FEATURES & BENEFITS



Food Preparation Centre



18/10 Stainless Steel



Push Button Remote Waste



Hidden Overflow



Sound Deadening Pads

BARE SINK OPTION AND SOME SINK & TAP PACKAGES DO NOT INCLUDE ACCESSORIES. PLEASE CHAT TO YOUR SALES CONSULTANT FOR FURTHER INFORMATION.

LAST UPDATED: 23 JULY 2021

FRANKE

CO

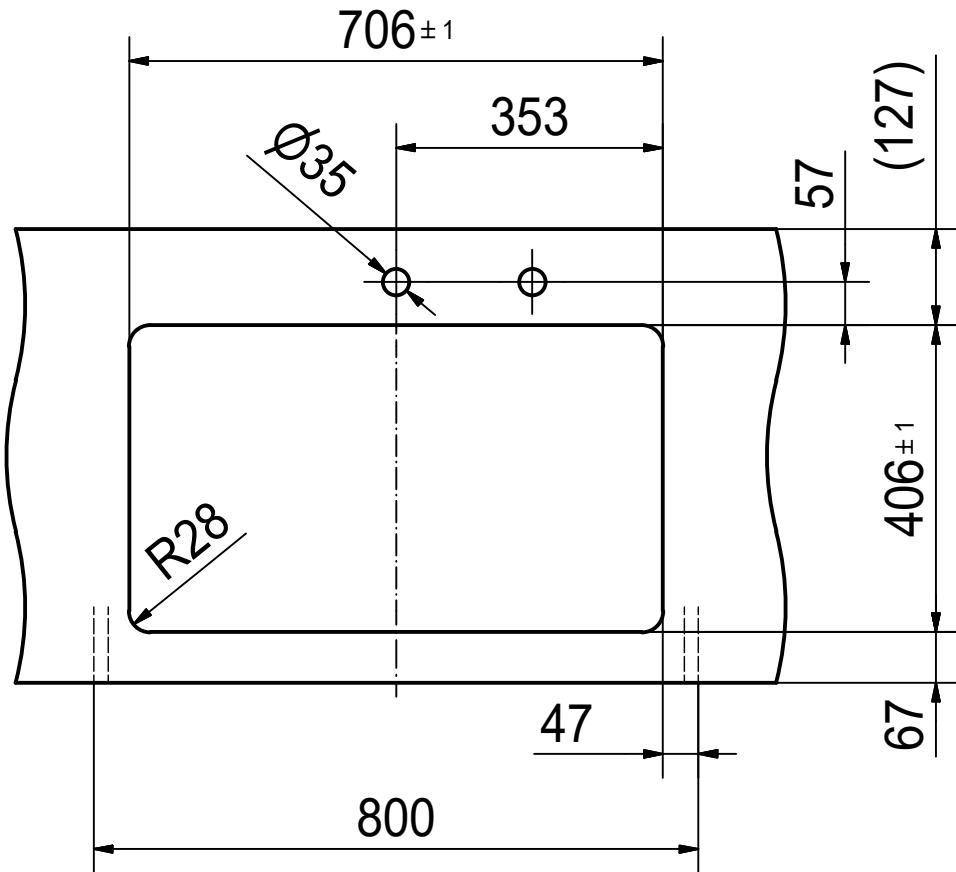

for flush fit only

712.4 x 412.4 x R31.2

(tolerance: +0.5/0)

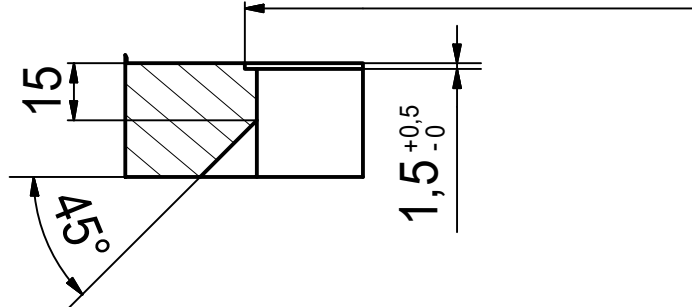

Drawing No. 20140371_01

Revision

Drawn Date 07.06.2019

FRANKE

MYX 210-70 I
installing document

Sheet Sheets

3 6

These drawings and specifications are the property of Franke Technology and Trademark Ltd. and shall not be reproduced, copied or transferred to any third party without the prior written permission of Franke Technology and Trademark Ltd., Hergiswil, Switzerland