

XS2F/XS3F/XS5FW/C, Y92E, XW3D

For a wide range of applications and environments the family of sensor connectors are the ideal match for the OMRON sensor portfolio. The line up is optimized to provide the best performance fit and value for money.

- M8, M12, fiber amplifier and photomicrosensor connectors
- 2, 3, 4, 5 and 8-wires
- wide application range from standard to special environments and performance requirements
- different cable and housing materials



Table of content





Cable connectors – quick guide and selection table 2
XS2F-M12 – M12 Basic line Cable type 4
XS3F-M8 – M8 Basic line Cable type 7
XS-L – M8 and M12 Sensor Connectors 9
Y92E-M12_8 – M12 8-Pin Sensor Connectors 12
XS, Y92E – M8 and M12 Robotic Sensor Connectors 13
Y92E-S_PP – Detergent and wash-down resistant polypropylene cable connectors (M8 / M12) 17
XS5W – Round Water-resistant Connectors (M12 Smartclick) 19
XS5F – Twist & click (M12). 23
XS2C/G, XS5C/G, Y92E-_-conf – Confectionable plugs and connectors (self-assembly) 24
XW3D – Connector Terminal Boxes 27
E3X-CN – Fiber amplifier connectors 31
EE-1 – Photomicrosensor connectors 33
XS2 – T-connectors, Covers, Accessories, extended wiring portfolio 35

XS2F/XS3F/XS5F/W/C, Y92E, XW3D

Cable connectors – quick guide and selection table

Size	Shape	Type	Features	Material		Order code		Extended Portfolio and Specs on Page
				Nut	Cable			
M8		Pro Line	3 pin	Brass (CuZn)	PVC 2 m	XS3F-M8PVC3S2M	XS3F-M8PVC3A2M	7
			4 pin		PUR 2 m	XS3F-M8PUR3S2M	XS3F-M8PUR3A2M	
			4 pin		PVC 2 m	XS3F-M8PVC4S2M	XS3F-M8PVC4A2M	
					PUR 2 m	XS3F-M8PUR4S2M	XS3F-M8PUR4A2M	
		Lite Line	3 pin	Brass (CuZn)	PVC 2 m	XS3F-LM8PVC3S2M	XS3F-LM8PVC3A2M	9
			4 pin			XS3F-LM8PVC4S2M	XS3F-LM8PVC4A2M	
		Detergent resistant Wash-down	4 pin	Stainless steel (SUS316L)	PP ¹ 2 m	Y92E-S08PP4S 2M-L	Y92E-S08PP4A 2M-L	17
			4 pin	Brass (CuZn)	Robotic PVC 2 m	XS3F-M421-402-R	XS3F-M422-402-R	13
Robotic PUR 2 m	Y92E-M08PUR4S2M-L	Y92E-M08PUR4A2M-L						
High robotic PUR 2 m	Y92E-M08PUR4S2M-R	Y92E-M08PUR4A2M-R						
M12 ²		Pro Line	3 wire	Brass (CuZn)	PVC 2 m	XS2F-M12PVC3S2M	XS2F-M12PVC3A2M	4
			4 wire		PUR 2 m	XS2F-M12PUR3S2M	XS2F-M12PUR3A2M	
			4 wire		PVC 2 m	XS2F-M12PVC4S2M	XS2F-M12PVC4A2M	
					PUR 2 m	XS2F-M12PUR4S2M	XS2F-M12PUR4A2M	
			5 wire		PVC 2 m	XS2F-M12PVC5S2M	XS2F-M12PVC5A2M	
					PUR 2 m	XS2F-M12PUR5S2M	XS2F-M12PUR5A2M	
		Lite Line	3 wire	Brass (CuZn)	PVC 2 m	XS2F-LM12PVC3S2M	XS2F-LM12PVC3A2M	9
			4 wire			XS2F-LM12PVC4S2M	XS2F-LM12PVC4A2M	
		LED (power and output LED, PNP/NPN)	3 wire	Nickel plated brass	PVC 2 m	-	XS2F-M12PVC3A2MPLIED	4
			4 wire			-	XS2F-M12PVC4A2MPLIED	
			3 wire		PUR 2 m	-	XS2F-M12PUR3A2MPLIED	
			4 wire			-	XS2F-M12PUR4A2MPLIED	
		Detergent resistant Wash-down	4 wire	Stainless steel (SUS316L)	PP ¹ 2 m	Y92E-S12PP4S 2M-L	Y92E-S12PP4A 2M-L	17
			4 wire	Stainless steel (SUS316L)	Heat resistant PVC 2 m	XS2F-E421-D80-E	XS2F-E422-D80-E	4
		Twist & click	4 wire	Nickel plated Zinc	PVC 2 m	XS5F-D421-D80-F	XS5F-D422-D80-F	23
					PUR 2 m	XS5F-D421-D80-P	XS5F-D422-D80-P	
4 wire		Brass (CuZn)	Robotic PVC 2 m	XS2F-D421-D80-F	XS2F-D422-D80-F	13		
			Robotic PUR 2 m	Y92E-M12PUR4S2M-L	Y92E-M12PUR4A2M-L			
4 wire	High robotic (drag chain & torsion)	High grade robotic PUR 2 m	Y92E-M12PUR4S2M-R	Y92E-M12PUR4A2M-R				
	8 pin	8 wire shielded cable	Brass (CuZn)	Shielded PUR 2m	Y92E-M12PURSH8S2M-L	-	12	
Fiber amplifier (E3X) connector		Fiber amplifier connectors	Special fiber connector - 4 wire	PBT	PVC 2 m	E3X-CN21	31	
			Special fiber connector+ M8 plug	Plug: Zinc diecast	PVC 30 cm with M8 4-pin plug	E3X-CN21-M3J-2 0.3M		
			Special fiber connector+ M12 plug		PVC 30 cm with M12 4-pin plug	E3X-CN21-M1J 0.3M		

XS2F/XS3F/XS5F/W/C, Y92E, XW3D

Size	Shape	Type	Features	Material		Order code		Extended Portfolio and Specs on Page
				Nut	Cable			
M8/M12		Confectionable	Plugs and connectors for self assembly	Brass	n.a.	XS2C/G, XS5C/G Y92E_conf		24
M12		Field I/O boxes	Direct wiring or DeviceNet communication	–		XW3D		31
M8/M12		T-connectors, covers, accessories and extended wiring portfolio	n.a.	–		XS2R, XS3R, XY2F, ...		35

¹ PP - polypropylene

² For details on pin configuration refer to specifications

XS2F-M12

Water- and Environment-resistive FA Connectors

Save Wiring and Maintenance Effort

- Compact FA connectors meet IP67 requirements and ensure a 94V-0 fire retardant rating.
- A wide array of connectors makes a wiring system more modular, simplifies maintenance, and reduces downtime.
- IEC61076-2-101(IEC60947-5-2)
- Lineup of connectors with LEDs for easy visual confirmation of Sensor operating status.



Ratings and Specifications

Item	XS2F-M12□□□□□□M XS2W-M12□□□□□□M	XS2F-M12□□□□A□□M□LED
Rated current	4A	
Rated voltage	125 VDC	24 VDC
Contact resistance (Connector)	40 mΩ max. (20 mV max., 100 mA max.)	
Insulation resistance	1,000 MΩ min. (at 500 VDC)	-
Dielectric strength (Connector)	AC 1,500 V 1 min. (leakage current: 1 mA max.).	
Degree of protection	IP67 (IEC60529)	
Temperature range	-10 to +80°C	

Materials and Finish

Contacts	Copper alloy/ nickel base, gold plating
Pin block	PBT resin (UL94 V-0)
Fixtures	Copper alloy/ nickel plating
Cover	PBT resin (UL94V-0)

PVC Cable

Item	3 cores	4 cores
Color	Black	
Outer diameter	5 mm dia.	5 mm dia. *
Conductor size	AWG23 0.25 mm ² (32/0.1)	
Approvals	AWM2464	
Features	Flame retardant	

*LED Type is 5.4 mm dia.

PUR Cable

Item	3 cores	4 cores
Color	Black	
Outer diameter	4.3 mm dia.	4.7 mm dia.
Conductor size	AWG22 0.32 mm ² (42/0.1)	
Approvals	AWM20936	
Features	Flame retardant Halogen free Oil resistance	

Connector Pinout Diagram (from Mating Side)

Item	No. of poles	4 poles
DC type	Male (plug) contacts	
	Female (socket) contacts	

XS2F M12 Sockets on One Cable End

XS2F-M12PVC□□□□M PVC cable

XS2F-M12PUR□□□□M PUR cable

Dimensions

(Unit: mm)

Straight

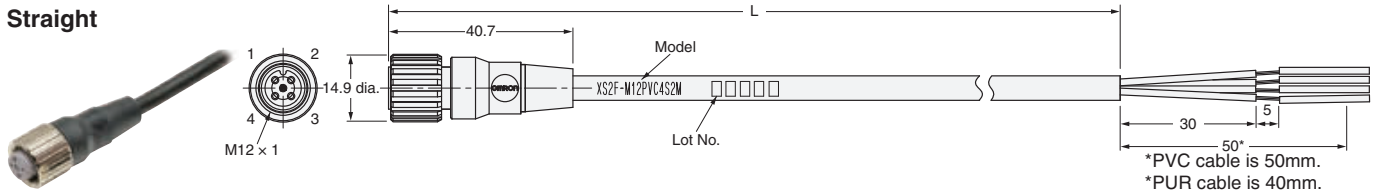

Right-angle

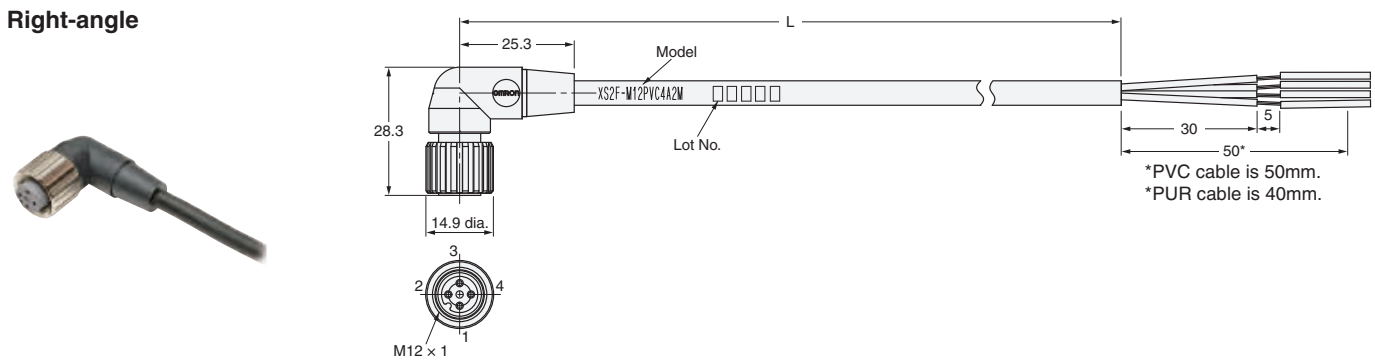

Note: For 3-core, pin 2 is not connected internally

Wiring Diagram

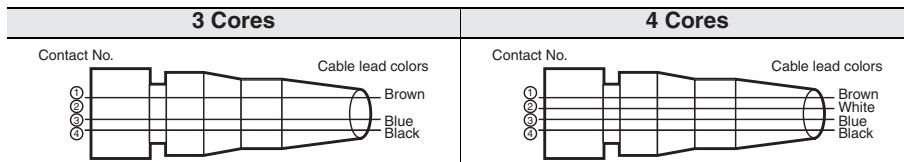

Ordering Information

Cable type	No. of cable cores	Cable outer diameter	Cable connection direction	Cable length (m)	Model
PVC	3	5.0 dia	Straight	2	XS2F-M12PVC3S2M
				5	XS2F-M12PVC3S5M
				10	XS2F-M12PVC3S10M
			Right-angle	2	XS2F-M12PVC3A2M
				5	XS2F-M12PVC3A5M
				10	XS2F-M12PVC3A10M
	4		Straight	2	XS2F-M12PVC4S2M
				5	XS2F-M12PVC4S5M
				7	XS2F-M12PVC4S7M
			Right-angle	10	XS2F-M12PVC4S10M
				2	XS2F-M12PVC4A2M
				5	XS2F-M12PVC4A5M
PUR	3	4.3 dia	Straight	2	XS2F-M12PUR3S2M
				5	XS2F-M12PUR3S5M
				10	XS2F-M12PUR3S10M
			Right-angle	2	XS2F-M12PUR3A2M
				5	XS2F-M12PUR3A5M
				10	XS2F-M12PUR3A10M
	4		Straight	2	XS2F-M12PUR4S2M
				5	XS2F-M12PUR4S5M
				10	XS2F-M12PUR4S10M
			Right-angle	2	XS2F-M12PUR4A2M
				5	XS2F-M12PUR4A5M
				10	XS2F-M12PUR4A10M

XS2F M12 Sockets on One Cable End with LED

XS2F-M12PVC□A□□M□LED PVC Cable

XS2F-M12PUR□A□□M□LED PUR Cable

Dimensions

(Unit: mm)

Right-angle

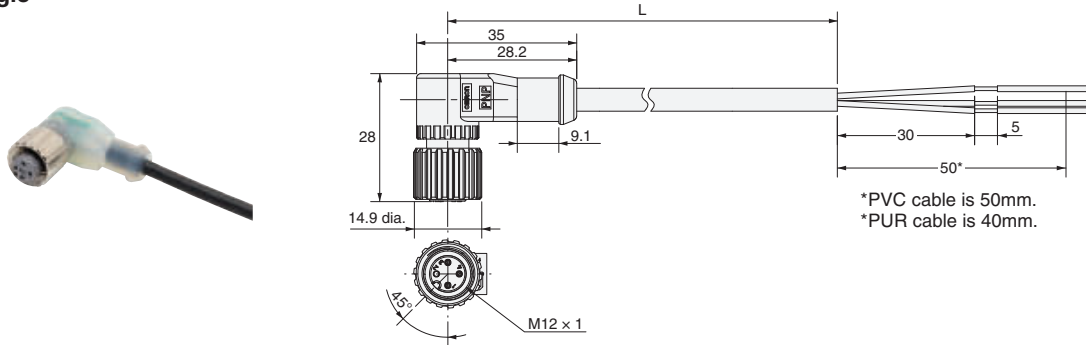

Wiring Diagram

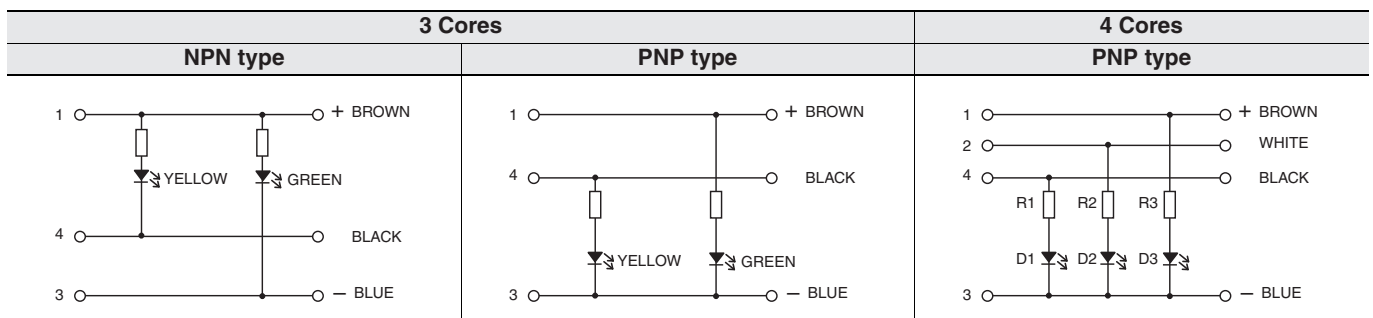

Ordering Information

Cable type	No. of cable cores	Cable outer diameter	Cable connection direction	Cable length (m)	Model	LED
PVC	3	5.0 dia.	Right-angle	2	XS2F-M12PVC3A2MPLED	PNP
				5	XS2F-M12PVC3A5MPLED	
				10	XS2F-M12PVC3A10MPLED	
	4	5.4 dia.		2	XS2F-M12PVC3A2MNLED	NPN
				5	XS2F-M12PVC3A5MNLED	
				10	XS2F-M12PVC3A10MNLED	
PUR	3	4.3 dia.	Right-angle	2	XS2F-M12PVC4A2MPLED	PNP
				5	XS2F-M12PVC4A5MPLED	
				10	XS2F-M12PVC4A10MPLED	
	4	4.7 dia.		2	XS2F-M12PUR3A2MPLED	PNP
				5	XS2F-M12PUR3A5MPLED	
				10	XS2F-M12PUR3A10MPLED	
4	4.7 dia.	2	XS2F-M12PUR4A2MPLED	PNP		
		5	XS2F-M12PUR4A5MPLED			
		10	XS2F-M12PUR4A10MPLED			

M8 Basic line Cable type

XS3F-M8

Small Round Water-resistant Connectors

- Water-resistant, compact connector meets IP67 requirements.
- Ideal for a wide variety of FA and OA applications.
- Connectors on both cable ends require no harness work.



Ratings and Specifications

Rated current	1A
Rated voltage	125 VDC
Contact resistance (Connector)	40 mΩ max. (20 mV max., 100 mA max.)
Insulation resistance	1,000 MΩ min. (at 500 VDC)
Dielectric strength (Connector)	AC 1,000 V 1 min. (leakage current: 1 mA max.)
Degree of protection	IP67 (IEC60529)
Temperature range	-10 to +80°C

Materials and Finish

Contacts	Copper alloy/ nickel base, gold plating
Pin block	PBT resin (UL94 V-0)
Fixtures	Copper alloy/ nickel plating
Cover	PBT resin (UL94V-0)

PVC Cable

Item	3, 4 cores
Color	Black
Outer diameter	5 mm dia.
Conductor size	AWG23 0.25 mm ² (32/0.1)
Approvals	AWM2464
Features	Flame retardant

PUR Cable

Item	3 cores	4 cores
Color	Black	
Outer diameter	4.3 mm dia.	4.7 mm dia.
Conductor size	AWG22 0.32 mm ² (42/0.1)	
Approvals	AWM20936	
Features	Flame retardant Halogen free Oil resistance	

Connector Pinout Diagram (from Mating Side)

Item	Poles	3 poles	4 poles
DC	Male (plug) contacts		
	Female (socket) contacts		

XS3F M8 Sockets on One Cable End

XS3F-M8PVC□□□□M PVC cable

XS3F-M8PUR□□□□M PUR cable

Dimensions

(Unit: mm)

Straight

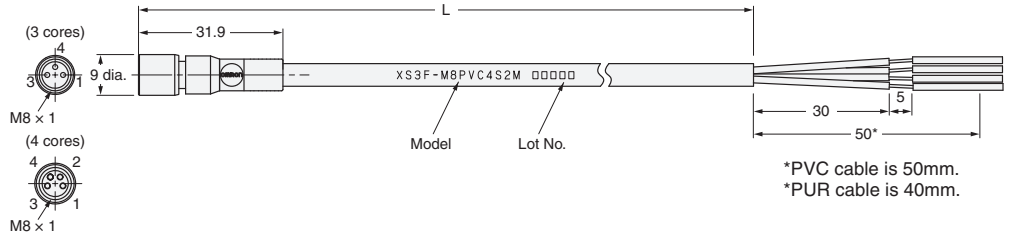

Right-angle

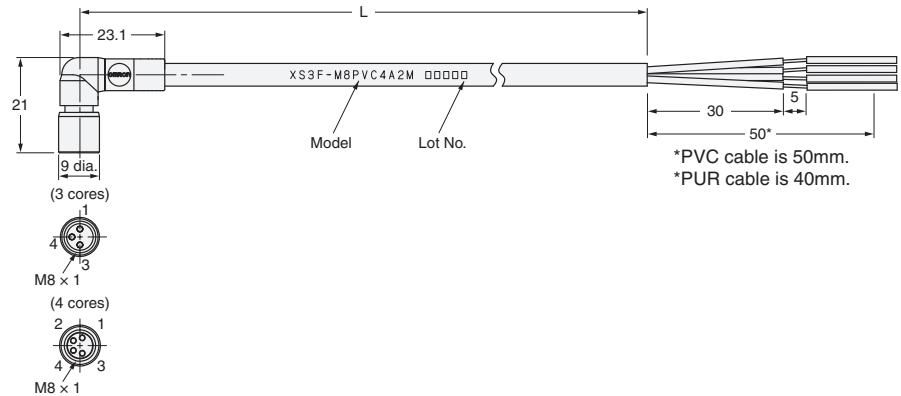

Wiring Diagram

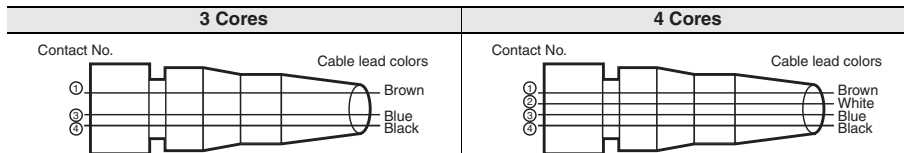

Ordering Information

Cable type	No. of cable cores	Cable outer diameter	Cable connection direction	Cable length (m)	Model
PVC	3	5.0 dia.	Straight	2	XS3F-M8PVC3S2M
				5	XS3F-M8PVC3S5M
				10	XS3F-M8PVC3S10M
			Right-angle	2	XS3F-M8PVC3A2M
				5	XS3F-M8PVC3A5M
				10	XS3F-M8PVC3A10M
	4	5.0 dia.	Straight	2	XS3F-M8PVC4S2M
				5	XS3F-M8PVC4S5M
			Right-angle	10	XS3F-M8PVC4S10M
				2	XS3F-M8PVC4A2M
PUR	3	4.3 dia.	Straight	2	XS3F-M8PUR3S2M
				5	XS3F-M8PUR3S5M
				10	XS3F-M8PUR3S10M
			Right-angle	2	XS3F-M8PUR3A2M
				5	XS3F-M8PUR3A5M
				10	XS3F-M8PUR3A10M
	4	4.7 dia.	Straight	2	XS3F-M8PUR4S2M
				5	XS3F-M8PUR4S5M
			Right-angle	10	XS3F-M8PUR4S10M
				2	XS3F-M8PUR4A2M
5	XS3F-M8PUR4A5M				
	10	XS3F-M8PUR4A10M			

M8 and M12 Sensor Connectors









XS_-L

The XS_-L family provides reliable operation in standard factory environments. The M8 and M12 sensors are designed to match the specifications of OMRON Lite Line sensors and provide excellent value for money.

- M8 and M12 brass female connectors
- 3-wire and 4-wire PVC cables
- ideal specification match for sensor usage in standard factory environments



Ordering Information

Type	Size	Cable material	Features	Shape	Cable length	Order code	
Sensor connector with open cable end for standard factory environments	M8  	PVC	3-wire		2 m	XS3F-LM8PVC3S2M	
					5 m	XS3F-LM8PVC3S5M	
					2 m	XS3F-LM8PVC3A2M	
			5 m		XS3F-LM8PVC3A5M		
			M12 	3-wire		2 m	XS2F-LM12PVC3S2M
						5 m	XS2F-LM12PVC3S5M
					2 m	XS2F-LM12PVC3A2M	
				5 m	XS2F-LM12PVC3A5M		
	4-wire				2 m	XS2F-LM12PVC4S2M	
					5 m	XS2F-LM12PVC4S5M	
				2 m	XS2F-LM12PVC4A2M		
						5 m	XS2F-LM12PVC4A5M

Specifications

	M8	M12
Wire size	0.25 mm ²	0.34 mm ²
Rated current	0.5 A	0.8 A
Rated voltage	30 VDC	
Degree of protection	IP67 (IEC 60529)	
Ambient temperature	-10°C to 65°C	

Pin arrangement

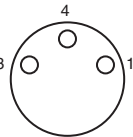
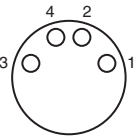
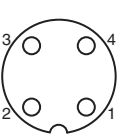
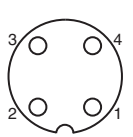
M8 3-wire	M8 4-wire	M12 3-wire	M12 4-wire
 1 = brown 3 = blue 4 = black	 1 = brown 2 = white 3 = blue 4 = black	 1 = brown 2 = n.c. 3 = blue 4 = black	 1 = brown 2 = white 3 = blue 4 = black

XS_-L

Dimensions

(Unit: mm)
Tolerance class IT16 applies to dimensions in this data sheet unless otherwise specified.

XS3F

M8 Screw-on cable connectors

3-wire

Straight connectors

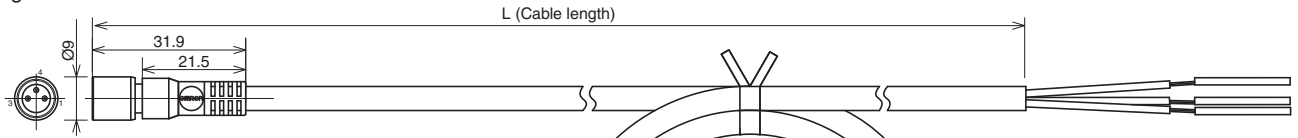

L-shaped connectors

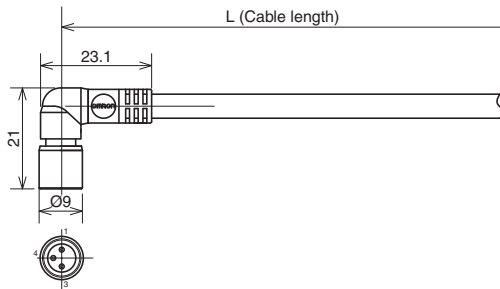

4-wire

Straight connectors

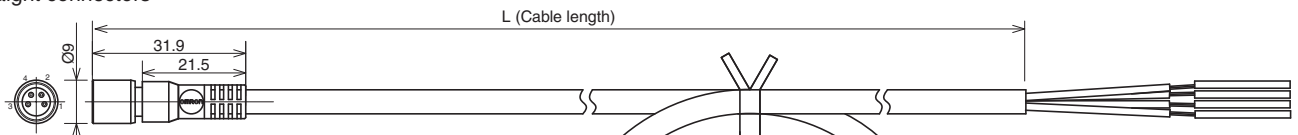

L-shaped connectors

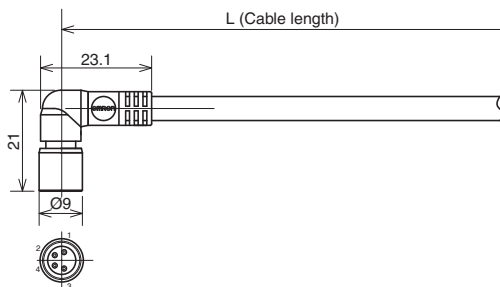

XS2F

M12 Screw-on cable connectors

3-wire

Straight connectors

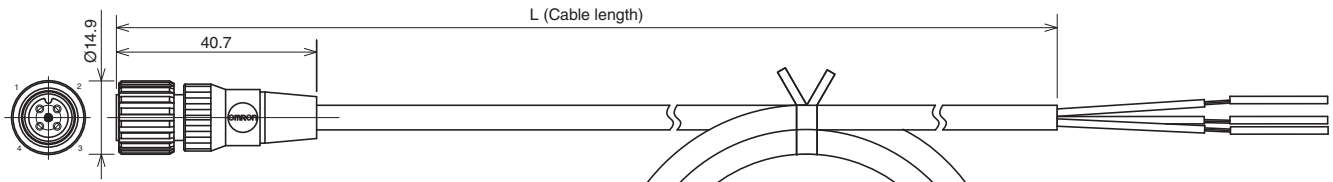

L-shaped connectors

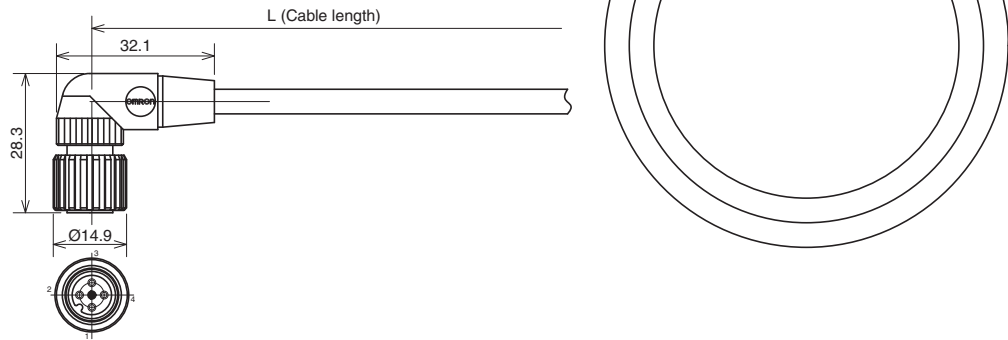

4-wire

Straight connectors

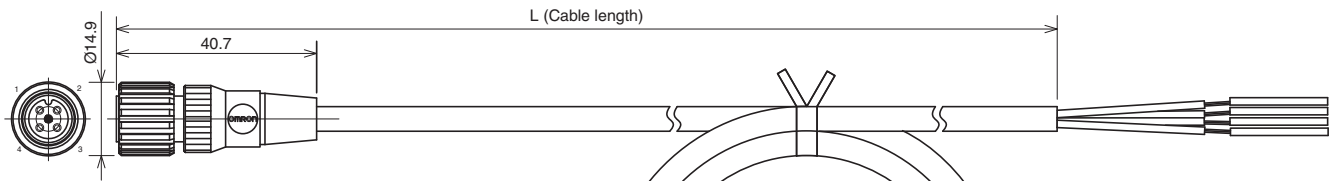

L-shaped connectors

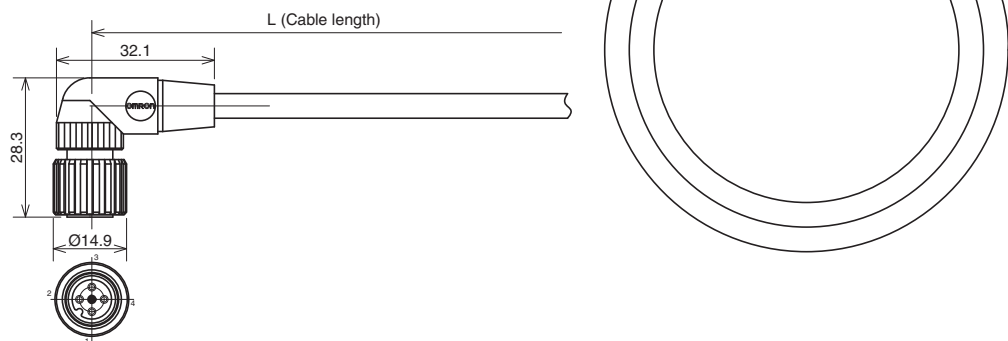

M12 8-Pin Sensor Connectors

Y92E-M12_8

For the connection of sensors with M12 8-pin connectors, the Y92E-M12_8 family provides error-free signal transmission in standard and challenging environments.

- M12 8-pin brass connectors
- Halone-free PUR cable with outer shielding layer



Ordering Information

Type	Size	Cable material	Features	Shape	Cable length	Order code
Sensor connector with open cable end	M12	PUR	8-pin, outer shielding layer		2 m	Y92E-M12PURSH8S2M-L
					5 m	Y92E-M12PURSH8S5M-L
					10 m	Y92E-M12PURSH8S10M-L
					25 m	Y92E-M12PURSH8S25M-L
Female-male extension connector	M12	PUR	8-pin, outer shielding layer		0.6 m	Y92E-M12FSM12MSPURSH806M-L
					2 m	Y92E-M12FSM12MSPURSH82M-L
					5 m	Y92E-M12FSM12MSPURSH85M-L
Male-male extension connector	M12	PUR	8-pin, outer shielding layer		10 m	Y92E-M12FSM12MSPURSH810M-L
					0.3 m	Y92E-M12MSM12MSPURSH80.3M-L
					0.9 m	Y92E-M12MSM12MSPURSH80.9M-L

Specifications

		Y92E-M12_8
Wire size		0.25 mm ²
Rated current		4 A
Rated voltage		30 VDC
Degree of protection		IEC 60529: IP67
Ambient temperature		-25°C to 80°C
Rated standards		AWM 21198
	Flame retardant	IEC 60332-2-2 CSA FT2
	Halone free	IEC 60754-1
	RoHS	2002/95/EC

Dimensions

(Unit: mm)
Tolerance class IT16 applies to dimensions in this data sheet unless otherwise specified.

Y92E-M12_8 (female)

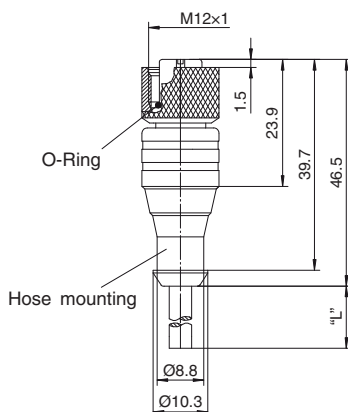

Y92E-M12_8 (male)

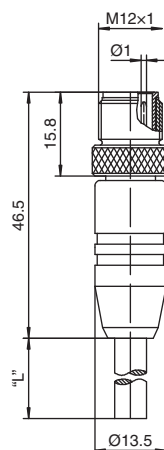

Pin arrangement

M12 8-pin (female)	
	1 = white 2 = brown 3 = green 4 = yellow 5 = grey 6 = pink 7 = blue 8 = red
M12 8-pin (male)	
	1 = white 2 = brown 3 = green 4 = yellow 5 = grey 6 = pink 7 = blue 8 = red

M8 and M12 Robotic Sensor Connectors











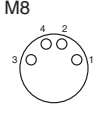





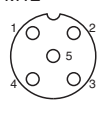





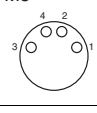

XS, Y92E

For demanding applications in drag chains or in the moving parts of robots, the robotic sensor connector family provides the bending and torsion performance required for reliable and long life operation.

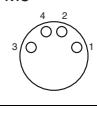
- M8 and M12 brass female connectors
- suitable for frequently or constantly moving applications
- > 2 Mio drag chain bending performance PVC or PUR models
- > 5 Mio drag chain bending and > 10 Mio torsion performance PUR models

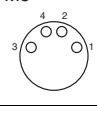

Ordering Information

Type	Size	Cable material	Bending performance (drag chain)	Torsion performance	Features	Shape	Cable length	Order code	
Sensor connector with open cable end and robotic cable	M8 	PVC	> 2 Mio	(not specified)	4-wire		2 m	XS3F-M421-402-R	
							5 m	XS3F-M421-405-R	
		PUR					2 m	XS3F-M422-402-R	
							5 m	XS3F-M422-405-R	
		PVC					2 m	Y92E-M08PUR4S2M-L	
							5 m	Y92E-M08PUR4S5M-L	
	M12 	PVC					2 m	Y92E-M08PUR4A2M-L	
							5 m	Y92E-M08PUR4A5M-L	
		PUR					2 m	XS2F-D421-D80-F	
							5 m	XS2F-D421-G80-F	
						2 m	XS2F-D422-D80-F		
						5 m	XS2F-D422-G80-F		
Sensor connector with open cable end and high grade robotic cable	M8 	PUR	> 5 Mio	> 10 Mio	4-wire		2 m	Y92E-M12PUR4S2M-L	
							5 m	Y92E-M12PUR4S5M-L	
						M12 		2 m	Y92E-M12PUR4A2M-L
								5 m	Y92E-M12PUR4A5M-L
						M8 		2 m	Y92E-M08PUR4S2M-R
								5 m	Y92E-M08PUR4S5M-R
	M12 						2 m	Y92E-M08PUR4A2M-R	
							5 m	Y92E-M08PUR4A5M-R	
	M8 						2 m	Y92E-M12PUR4S2M-R	
							5 m	Y92E-M12PUR4S5M-R	
	M12 						2 m	Y92E-M12PUR4A2M-R	
							5 m	Y92E-M12PUR4A5M-R	

XS, Y92E

Bending and torsion performance

The bending and torsion performance of the robotic sensor connectors has been tested using the below test methods.

1. Bending (drag chain)

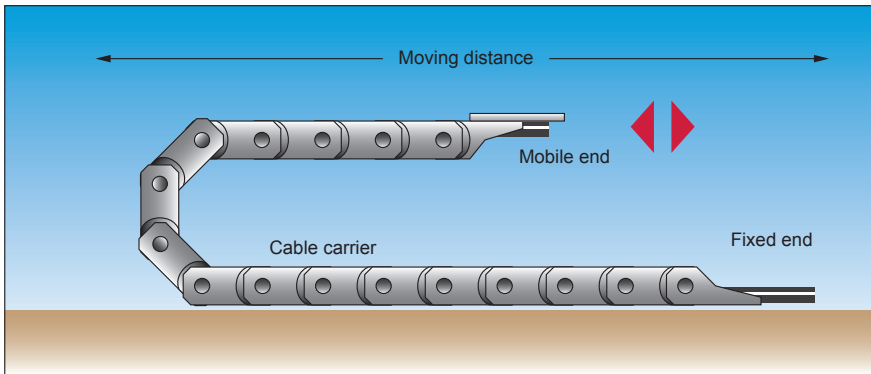

Cable carrier bending radius: approx. $9 \times$ cable outer diameter
Movement speed: PVC: 120 m/min (max)
PUR: 200 m/min (max); max 5 m/s²

2. Bending (left - right)*¹

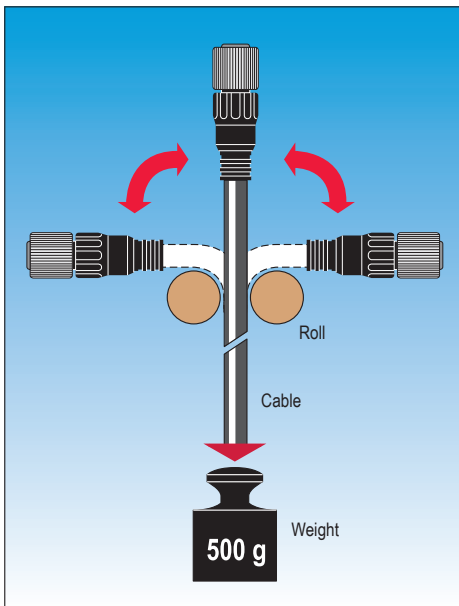

Bending angle: $\pm 90^\circ$
Bending speed: 35 cycles/min
Roll diameter: 60 mm

*¹ For PVC models

3. Torsion

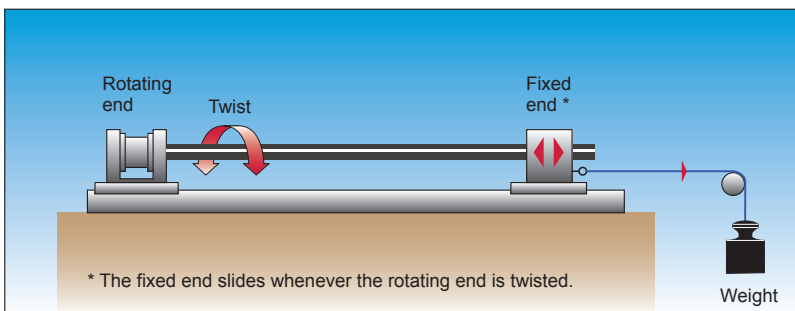

Torsion angle and length: PVC: $\pm 180^\circ$ over 0.5 m
PUR: $\pm 360^\circ$ over 1 m

Specifications

	Robotic PVC		Robotic PUR		High grade robotic PUR	
	XS3F-_-R	XS2F-_-F	Y92E-M_-L		Y92E-M_-R	
	M8	M12	M8	M12	M8	M12
Wire size	0.25 mm ²		0.34 mm ²			
Rated current	1A		4A			
Rated voltage	125 VDC		30 VDC	240 VDC	30 VDC	240 VDC
Degree of protection	IEC 60529: IP67					
Ambient temperature	Fixed			-50°C to 80°C		
	Moving			-25°C to 80°C		
	Continuous drag chain operation	-25° to 70°C		-25°C to 60°C		5°C to 60°C
Rated standards	Style	-	AWM 2464	AWM 20549		
	Flame retardant	-	UL VW1 CSA FT4	IEC 60332-2-2 CSA FT2		
	Halone free	-		IEC 60754-1		
	RoHS	2002/95/EC				

Pin arrangement

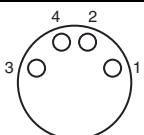
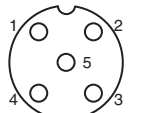
M8 4-pin	M12 4-wire
 <p>1 = brown 2 = white 3 = blue 4 = black</p>	 <p>1 = brown 2 = white 3 = blue 4 = black 5 = n.c.</p>

Dimensions

(Unit: mm)
Tolerance class IT16 applies to dimensions in this data sheet unless otherwise specified.

XS3F-_-R

Straight Connectors

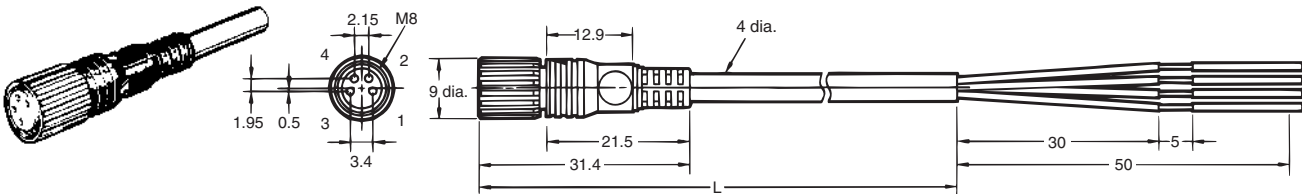

L-shaped Connectors

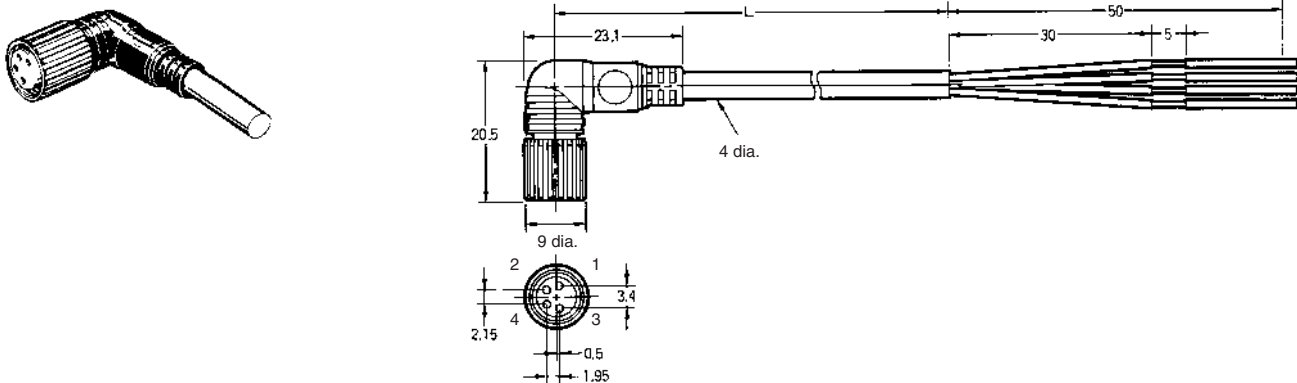

XS, Y92E

XS2F-_-F

Straight Connectors

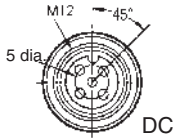
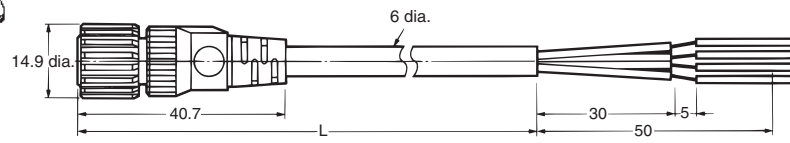
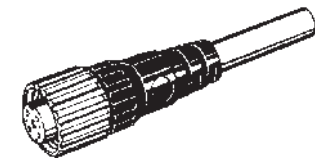

DC

L-shaped Connectors

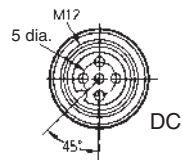
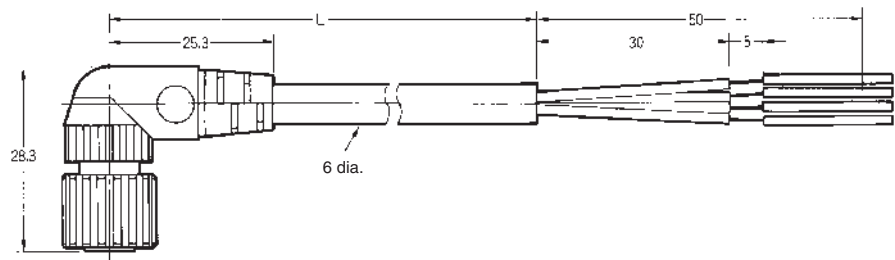

DC

Y92E-M08_

Straight Connectors

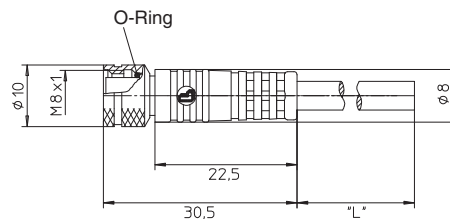
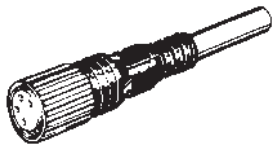

L-shaped Connectors

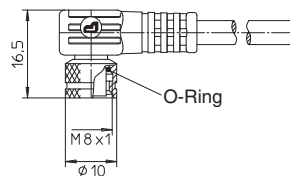

Y92E-M12_

Straight Connectors

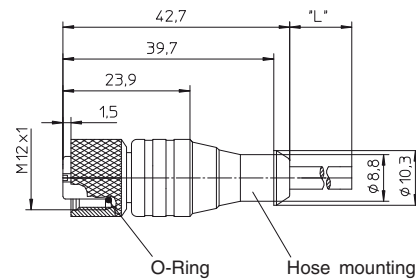
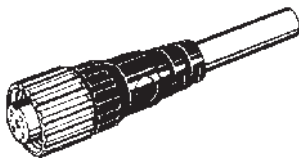

O-Ring

Hose mounting

L-shaped Connectors

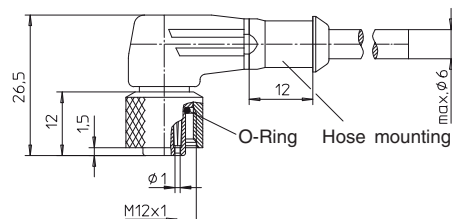

O-Ring

Hose mounting

Y92E-S_PP

- Highest operational reliability
- Strong flexibility due to the product variety
- Support of global industry standards (UL, ECOLAB, etc.)
- Increasing efficiency caused by superior handling characteristics as well as the potential to decrease costs



Ordering information

Detergent and wash-down resistant models

Type	Size	Material		Features	Shape	Length (m) ^{*1}	Order code	
		Nut	Cable					
Detergent resistant Wash-down	M8	SUS 316L	PP (Polypropylene)	3 pin	Angled	2	Y92E-S08PP3A 2M	
						5	Y92E-S08PP3A 5M	
					Straight	2	Y92E-S08PP3S 2M	
						5	Y92E-S08PP3S 5M	
					M12	Angled	2	Y92E-S08PP4A 2M
							5	Y92E-S08PP4A 5M
	Straight			2		Y92E-S08PP4S 2M		
				5		Y92E-S08PP4S 5M		
	Angled			2		Y92E-S12PP4A 2M		
				5		Y92E-S12PP4A 5M		
	Straight			2	Y92E-S12PP4S 2M			
				5	Y92E-S12PP4S 5M			

*1 For different cable length please contact your Omron representative

Specifications

Rated current	4 A
Rated voltage	M8: 60 VDC M12 4-wire: 250 VDC
Degree of protection	IP67 / IP68 / IP69K (IEC 60529)
Ambient temperature	-30 to 90°C
Approvals	UL-File Nr. E315587; ECOLAB

Pin arrangement

M8 3 pin		M8 4 pin		M12 4 pin	
	1 = brown 3 = blue 4 = black		1 = brown 2 = white 3 = blue 4 = black		1 = brown 2 = white 3 = blue 4 = black 5 = n.c.

Materials

Pin block	PP, white (Polypropylene)
Contacts	Cu/Au, 0.3 µm gold plating
Fixture	Stainless steel
Cover	PP (Polypropylene)
O-ring	EPDM
Cable sheath	TPE (Thermoplastic elastomers)

Y92E-S_PP

Dimensions

Y92E-S08PP

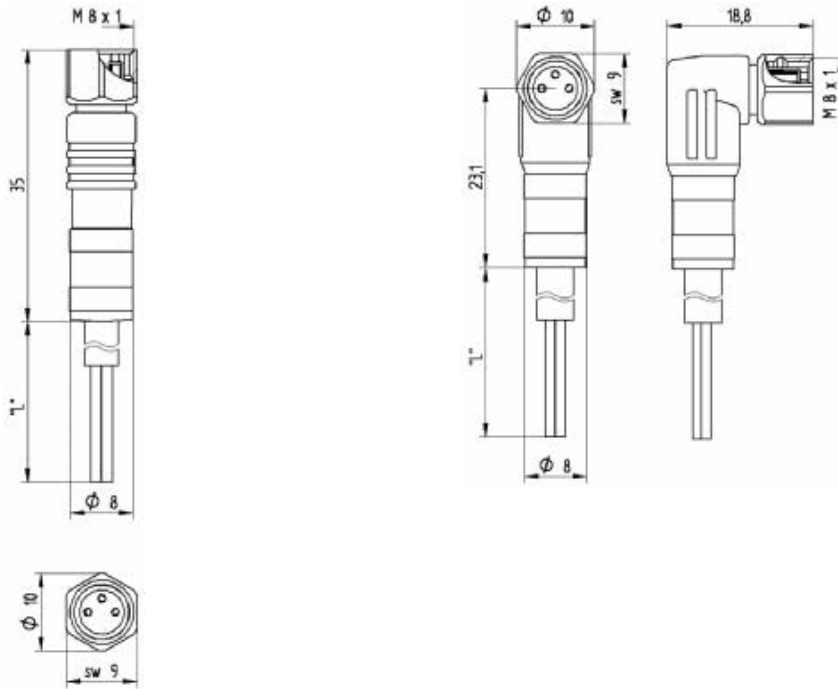

Y92E-S12PP

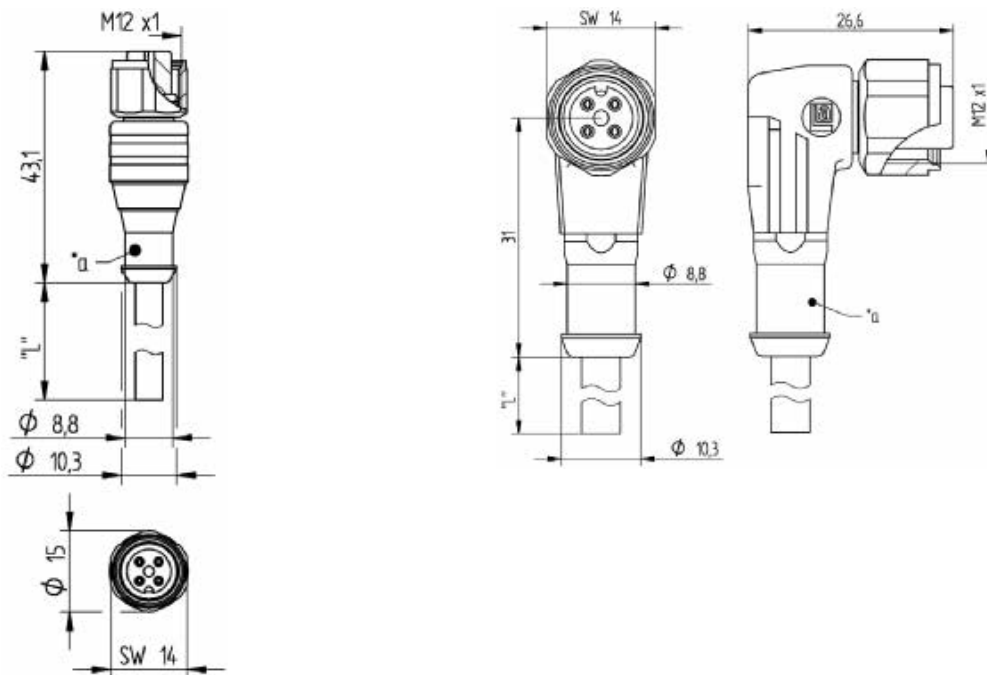

Wiring Diagram (M8 and M12)

Contact No.

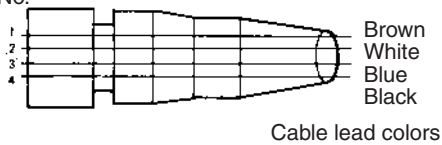

XS5W

Round Water-resistive Smartclick Connectors That Reduce Installation Work

- A newly developed lock mechanism that is compatible with round M12 connectors.
- Simply insert the Connectors, then turn them approximately 1/8 of a turn to lock.
- A positive click indicates locking.
- Features the same degree of protection (IP67) as M12 connectors.
- A full line-up of models is planned.
- Connectors with Cables are UL approved.



Ratings and Specifications

Rated current	4 A
Rated voltage	250 VDC
Contact resistance (connector)	40 mΩ max. (20 mV max., 100 mA max.)
Insulation resistance	1,000 MΩ min. (at 500 VDC)
Dielectric strength (connector)	1,500 VAC for 1 min (leakage current: 1 mA max.)
Degree of protection	IP67 (IEC60529)
Insertion tolerance	50 times min.
Lock strength	Tensile: 100 N/15 s, Torsion: 1 N·m/15 s
Cable holding strength	Tensile: 100 N/15 s, Torsion: 1 N·m/15 s (for cable diameter of 6 mm) *2
Lock operating force	0.1 to 0.25 N·m
Ambient operating temperature range	-25 to 70°C
Ambient humidity range	20% to 85%
Number of pressure-weld repairs *1	10 times max. (Limited to the same external diameter and wire diameter.)

*1. Only XS5C/G (IDC models)

*2. Refer to product specifications for details.



XS5W

Materials and Finishes

Item	Model	XS5F/H/W	XS5R	XS5M/P	XS5C/G (Crimping, Soldering)	XS5C/G (Screw-on)	XS5C/G (IDC models)
Contacts	Material	Phosphor bronze	Phosphor bronze or Brass	Phosphor bronze	Brass	Phosphor bronze or Brass	Phosphor bronze
	Finish	Nickel base, 0.4- μ m gold plating					Nickel base, 0.15- μ m gold plating
Fixtures		Nickel-plated zinc alloy					
Fixtures (Lock) *		Stainless					
Pin block		PBT resin (UL94V-0)					
O-ring		Rubber					
Overmolding/Cover		Soft PBT resin (UL94V-0)		---	PBT resin (UL94V-0)		
Cable	Fire-retardant, Robot cable	UL AWM2464 CL3, 6 mm dia., AWG20 (0.5mm ²) Structure: 0.08 mm/110 wires		---			
	Oil-resistant polyurethane cable	6 mm dia. AWG20 (0.5mm ²) Structure: 0.12 mm/45 wires		---			
	Spatter-resistant Cable	6.6 mm dia. AWG20 (0.5mm ²) Structure: 0.08 mm/100 wires		---			
Seal resin		---		Epoxy resin (UL94V-0)	---		
Power supply wires		---		UL1007 AWG20	---		

*Only plug

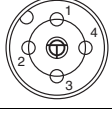
Connector Pinout Diagram (from Mating Side)

Item	No. of poles	4 poles
DC type	Male (plug) contacts	
	Female (socket) contacts	

Connection Combinations

OMRON model No.		Smartclick Plug Connectors	M12 Plug Connectors
		XS5H, XS5G, XS5W (plug side), XS5R (plug side), XS5M	XS2H, XS2G, XS2W (plug side), XS2R (plug side), XS2M
Smartclick Socket Connectors	XS5F, XS5C, XS5W (socket side), XS5R (socket side), XS5P	⊙	○
M12 Socket Connectors	XS2F, XS2C, XS2W (socket side), XS2R (socket side), XS2P	○	○

 is a registered trademark of the OMRON Corporation.

⊙ : Connected by twisting.

○ : Connected by screwing.

Note: The XS□M and XS□P cannot mate with each other.



XS5W Connectors Connected to Cable, Socket and Plug on Cable Ends

- Fire-retardant, Robot cable
- Oil-resistant Polyurethane Cable
- Spatter-resistant Cable

XS5W-D42□-□81-F
 XS5W-D42□-□81-P
 XS5W-D421-□81-SA

Dimensions

(Unit: mm)

Straight/straight

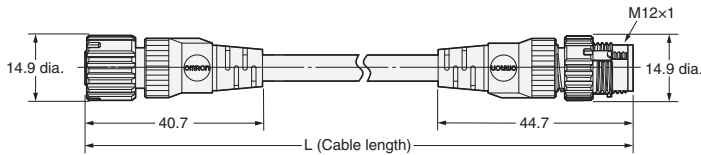

Angled/angled

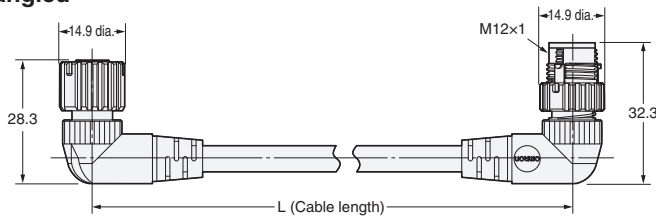

Straight/angled

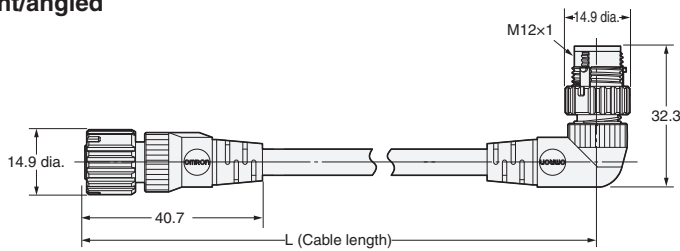

Angled/straight

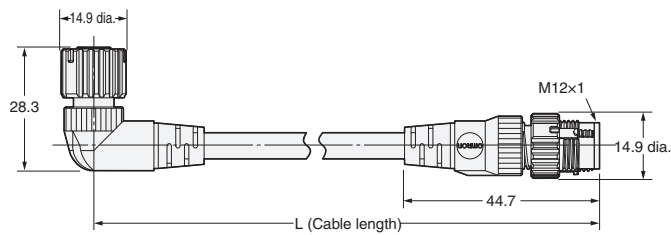

Wiring Diagram for 4 Cores

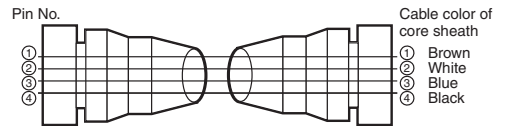

Note: Oil-resistant Polyurethane Cables (XS5W-D42□-□81-P) and Spatter-resistant Cable (XS5W-D421-□81-SA) have black covers.
 Fire-retardant, Robot cable (XS5W-D42□-□81-F) have warm gray covers.

XS5W

Model Number Legend

XS5W-D42 **81**

1 2 3 4 5 6 7 8 9

Use this model number legend to identify products from their model number. When ordering, use a model number from the table in *Ordering Information*.

1. Type

W: Connectors connected to cable, socket and plug on cable ends

2. Mating Section Form

D: DC

3. Connector Poles

4: 4 poles

4. Contact Plating

2: 0.4- μ m gold plating

5. Cable Connection Direction

- 1: Straight/straight
- 2: Angled/angled
- 3: Straight (Socket)/angled (Plug)
- 4: Angled (Socket)/straight (Plug)

6. Cable Length

- C: 1 m D: 2 m E: 3 m
- G: 5 m J: 10m

7. Connections

8: ① Brown, ② White, ③ Blue, ④ Black (Numbers inside circles are terminal numbers)

8. Connectors on One End/Both Ends

1: Both ends

9. Cable Specifications

- F: Fire-retardant, Robot cable
- P: Oil-resistant Polyurethane Cable
- SA: Spatter-resistant Cable

Ordering Information

Cable specifications	Cable length L (m)	Cable outer diameter (mm)	Straight/straight	Angled/angled	Minimum order	UL
			Model			
Fire-retardant, Robot cable	1	6	XS5W-D421-C81-F	---	10	Yes
	2		XS5W-D421-D81-F	XS5W-D422-D81-F	5	
	3		XS5W-D421-E81-F	---		
	5		XS5W-D421-G81-F	XS5W-D422-G81-F		
	10		XS5W-D421-J81-F	---	1	
Oil-resistant Polyurethane Cable	2	6	XS5W-D421-D81-P	---	5	---
	5		XS5W-D421-G81-P	---	1	
	10		XS5W-D421-J81-P	---		
Spatter-resistant Cable	2	6.6	XS5W-D421-D81-SA	---	5	---
	5		XS5W-D421-G81-SA	---		

Cable specifications	Cable length L (m)	Cable outer diameter (mm)	Straight (Socket)/angled (Plug)	Angled (Socket)/straight (Plug)	Minimum order	UL
			Model			
Fire-retardant, Robot cable	2	6	XS5W-D423-D81-F	XS5W-D424-D81-F	5	Yes
	5		XS5W-D423-G81-F	XS5W-D424-G81-F		

Ordering information

Type	Size	Material		Features	Shape	Length (m)	Order code
		Nut	Cable				
Twist & Click ^{*1}	M12	Brass	PVC ^{*2}	For standard 4 pin or Omron Smartclick connectors	Angled	2	XS5F-D422-D80-F
						5	XS5F-D422-G80-F
					Straight	2	XS5F-D421-D80-F
						5	XS5F-D421-G80-F

^{*1} The XS5F connectors can be attached to standard M12 plug connectors (screw-fix) and to XS5 plug connectors (twist & click). For details on the twist & click locking mechanism refer to XS5 data sheet.

^{*2} For PUR models replace -F by -P in the order code

Specifications

Rated current	4A
Rated voltage	125 VDC, 250 VAC
Degree of protection	IP67 (IEC 60529)
Ambient temperature	-25°C to 70°C

Pin arrangement

M12 4 poles

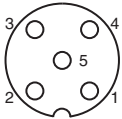

- 1 = brown
- 2 = white
- 3 = blue
- 4 = black
- 5 = n.c.

Materials

Pin block	PBT resin (UL94V-0)
Contacts	Phosphor bronze/nickel base, 0.4 µm gold plating
Fixture	Zinc alloy/nickel plated
Cover	Polyester elastomer (UL94V-0)
O-ring	Rubber

Dimensions

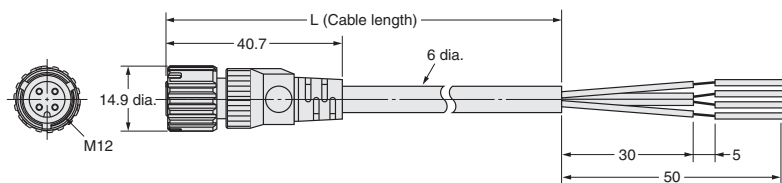

XS2C/G, XS5C/G, Y92E-__conf

Ordering information

Type	Size	Material Nut	Features	Shape	Order code	
Plug (male)	M8	Polyester elastomer	3 pin	straight	Y92E-MM08PVC3Sconf-L	
			4 pin		Y92E-MM08PVC4Sconf-L	
	M12		4 pin	IDC	straight	XS5G-D418
				crimp		XS2G-D4C3
				solder		XS2G-D423
				solder		XS2G-D424
			5 pin	screw fix	straight	XS2G-D5S1
			angled	XS2G-D5S2		
	4 pin twist & click (for 4-5 mm cables)		screw fix	straight	XS2G-D4S3	
	angled		XS2G-D4S4			
Connector (female)	M8	Polyester elastomer	3 pin	straight	Y92E-M08PVC3Sconf-L	
			4 pin		Y92E-M08PVC4Sconf-L	
	M12		4 pin	IDC	straight	XS5C-D418
				crimp		XS2C-D4C3
				solder		XS2C-D423
				crimp		XS2C-D4C4
			solder	XS2C-D424		
			5 pin	screw fix	straight	XS2C-D5S1
	angled		XS2C-D5S2			

Specifications

	Y92E	XS2C/G, XS5C/G
Rated current	4 A	
Rated voltage	36 VDC	125 VDC, 250 VAC
Degree of protection	IP67 (IEC60529)	
Ambient temperature	-25°C to 70°C	

Pin arrangement

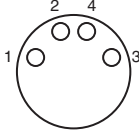
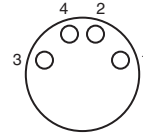
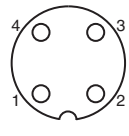
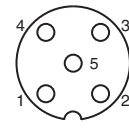
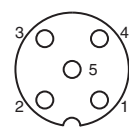
M8		M12			
Plug	Connectors	Plug		Connectors	
4 pin	4 pin	4 pin	5 pin	4 pin	5 pin
					
4 pin: 1 = brown 2 = white 3 = blue 4 = black			5 pin: 1 = brown 2 = white 3 = blue 4 = black 5 = n.c.		

Materials

	Y92E	XS2C/G, XS5C/G
Pin block	PVC	PBT resin (UL94V-0)
Contacts	CuSn, nickel base, 0.3 µm gold plating	Brass/nickel base, 0.4 µm gold plating
Fixture		Brass/nickel base
Cover	PVC	PBT resin (UL94V-0)
O-ring	FKM	Rubber

Dimensions

Plugs (male)

XS5G-D418 (IDC Model, Straight)

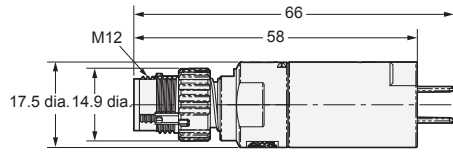

XS2G-D4C (Crimping Model, Straight), XS2G-D42 (Soldering Model, Straight)

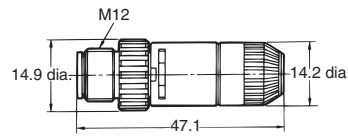
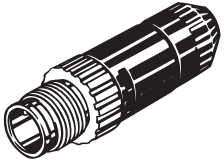

XS2G-D5S1 (Screw-on model, Straight)

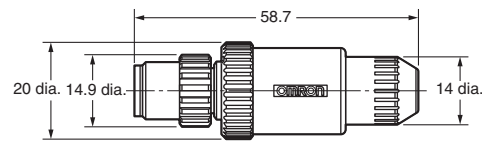
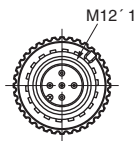
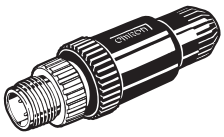

XS2G-D42 (Soldering Model, L-shaped)

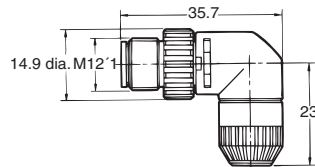

XS2G-D5S2 (Screw-on model, angled)

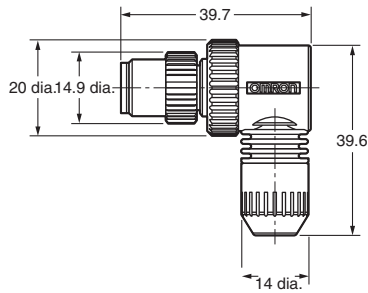
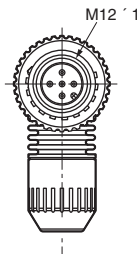
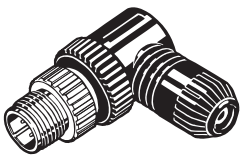

XS2C/G, XS5C/G, Y92E_-conf

Connectors (female)

XS5C-D418 (IDC Model, Straight)

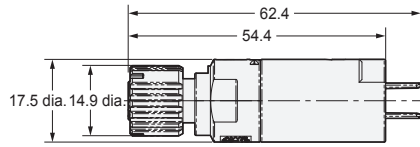
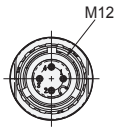

XS2C-D4C (Crimping Model, Straight),

XS2C-D42 (Soldering Model, Straight)

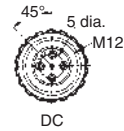
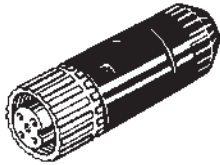

XS2C-D5S1 (Screw-on model, straight)

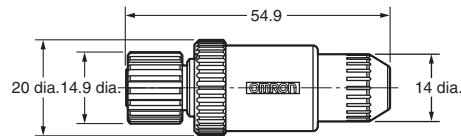
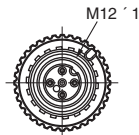

XS2C-D4C (Crimping Model, L-shaped)

XS2C-D42 (Soldering Model, L-shaped)

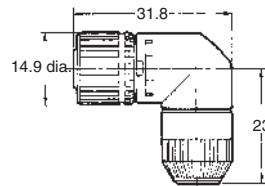
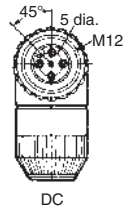
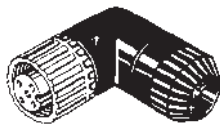

XS2C-D5S2 (Screw-on model, angled)

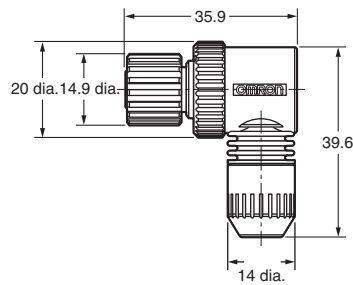
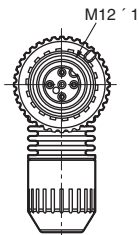
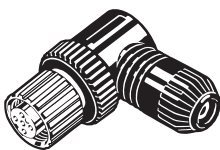

XW3D

Simple Wiring of Sensor Actuators

- Greatly reduce wiring in combination with the Smartclick XS5.
- Insert the connector and turn 1/8 of a turn to lock the connectors.
- Higher rated current to enable output applications.
- Use previous M12 screw connectors.

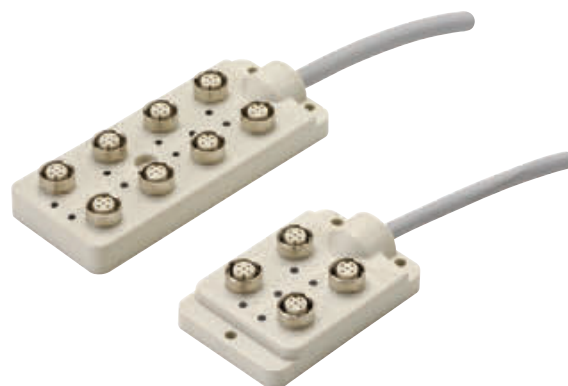

Specifications

Rated current	4 A/port, 12 A/Box (power line)
Rated voltage	10 to 30 VDC
Contact resistance (connector)	40 mΩ max. (20 mV max., 100 mA max.)
Insulation resistance	1,000 MΩ min. (at 500 VDC)
Dielectric strength (connector)	500 VAC for 1 min (leakage current: 1 mA max.)
Degree of protection	IP67 (IEC60529)
Insertion tolerance	50 times min.
Lock strength	Pulling: 100 N/15 s, Twisting: 1 N-m/15 s
Cable holding strength	100 N/15 s
Lock operating force	0.1 to 0.25 N-m
Ambient temperature range	Operating: -25 to 70°C

Materials and Finish

Item	Materials/finish
Contacts	Brass/nickel base, 0.4-μm gold-plating
Fixtures	Nickel-plated zinc alloy
Case	PBT resin (UL94V-O), light gray
Bushing	Rubber
O-ring	Rubber
PCB	Glass epoxy board
Sealing resin	Urethane resin (UL94V-0)
Cable	UL AWM2464 Signal lines: AWG22 Power and ground lines: AWG18

Connection Combinations

OMRON model no.		Twist-and-Click Plug Connectors	M12 Plug Connectors
		XS5H, XS5G, XS5W (plug end), XS5R (plug end)	XS2H, XS2G, XS2W (plug end), XS2R (plug end)
Connector Terminal Box	XW3D	◎	○

◎ : Connected by Smartclick.
○ : Connected by screwing.

Smartclick is a registered trademark of the OMRON Corporation.



XW3D

Ordering Information

Sensor type and wiring		3-wire DC NPN/2-wire DC 3-4	2-wire DC 1-4/without polarity 3-4	3-wire DC PNP/2-wire DC 1-4
Actuator wiring		Actuator wiring 1-4	—	Actuator wiring 3-4
No. of ports	No. of I/O	Model		
4	4	XW3D-P455-G11	XW3D-P452-G11	XW3D-P453-G11
8	8	XW3D-P855-G11	XW3D-P852-G11	XW3D-P853-G11
4	8	XW3D-P458-G11	—	XW3D-P457-G11

Note 1. "1-4" and "3-4" are the connector pin numbers that are wired.
 2. All cables are 5 m long.

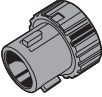
Waterproof Cover (Sold Separately)

Appearance	Model	No. per box	Material
	XS5Z-11	50	PBT
	XS2Z-22	50	Brass with Ni plating

Note 1. The XW3D/XW3B/XW3A comes with a dust cover. If IP67 degree of protection is required, use the XS5Z-11 or XS2Z-22 (sold separately).
 2. The XS2Z-22 connection is threaded.

Dimensions

(Unit: mm)

XW3D-P45□-G11 (Model with Four Ports)

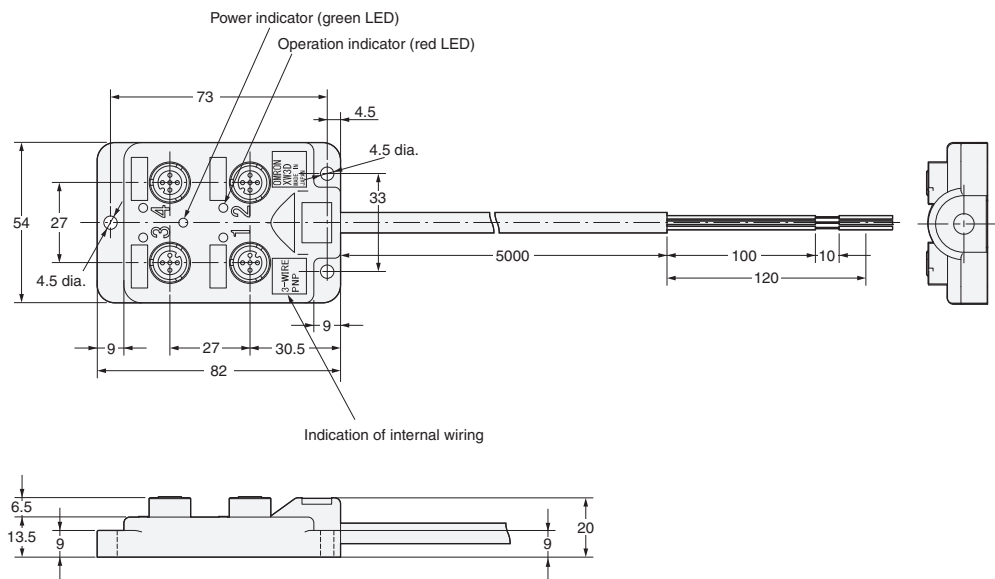

XW3D-P85□-G11 (Model with Eight Ports)

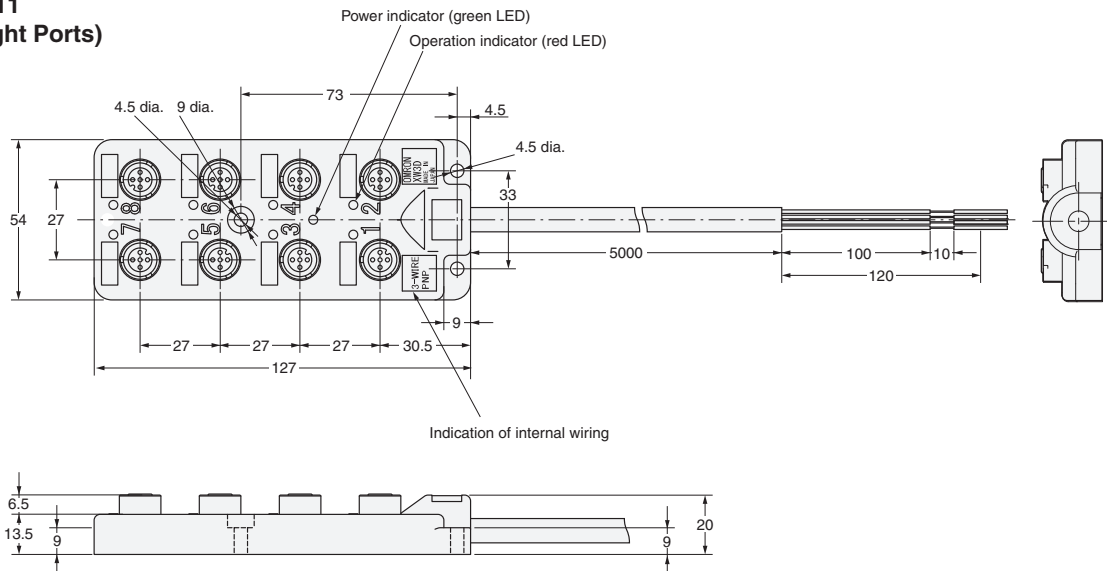

XW3D-P457-G11
(Model with Four Ports and Eight I/O)

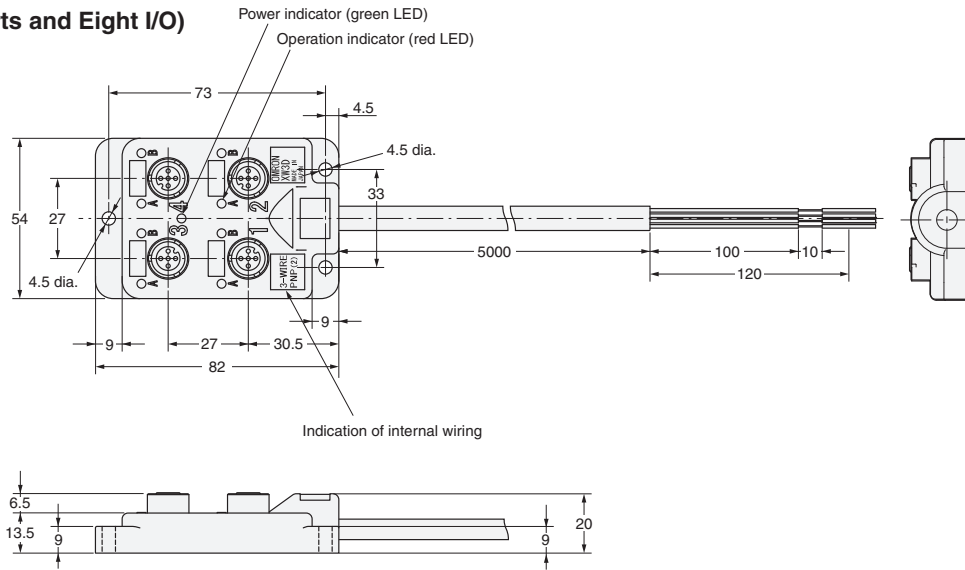

Wiring Diagrams

Models with One I/O and One Port

XW3D-P□55-□11
for 3-wire NPN,
2-wire DC (without polarity 3-4),
and Actuator (1-4)

3-WIRE
NPN

XW3D-P□52-□11
for 2-wire DC
(polarity 1-4, without polarity 3-4)

2-WIRE

Note: Cannot be used with NPN-type Photoelectric and Proximity Sensors. Cannot be used with Proximity Sensors with polarity 3-4.

XW3D-P□53-□11
for 3-wire PNP,
2-wire DC (with polarity 1-4),
and Actuator (3-4)

3-WIRE
PNP

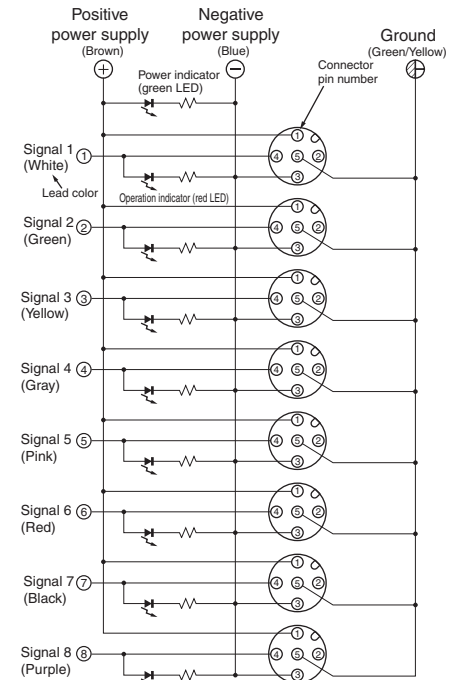
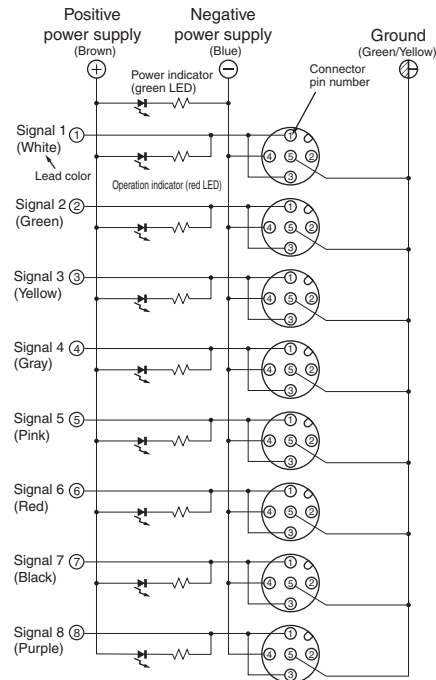
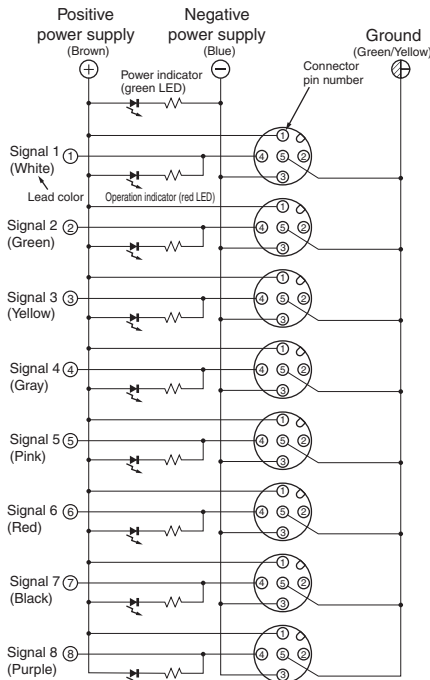

- Note 1. The above wiring diagrams are for eight-port use.
 2. Figures in parentheses indicate lead colors.
 3. The expression "white/red" means white and red stripes.
 4. Here, "1-4" and "3-4" are pin numbers.
 5. Contact numbers 5 through 8 in the above diagrams do not exist on Terminal Boxes with four ports. The lead colors for signals 1 through 4, power supply, and ground are the same.

Models with Two I/O and One Port

XW3D-P458-G11 for 3-wire NPN and Actuator (1-4 or 1-2)

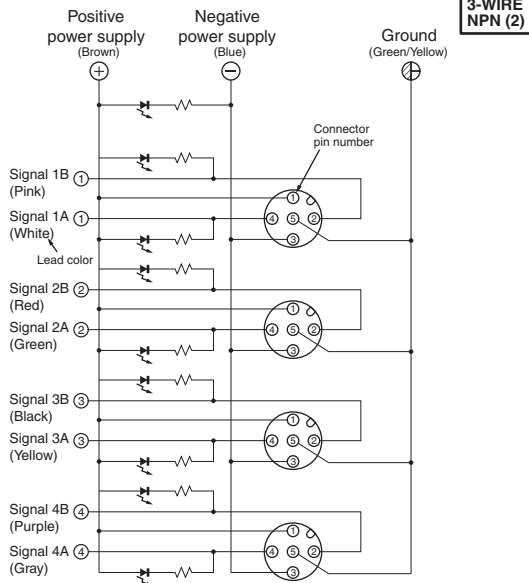

Note: Colors given in the connection diagram are lead colors.

XW3D-P457-G11 for 3-wire PNP and Actuator (3-4 or 3-2)

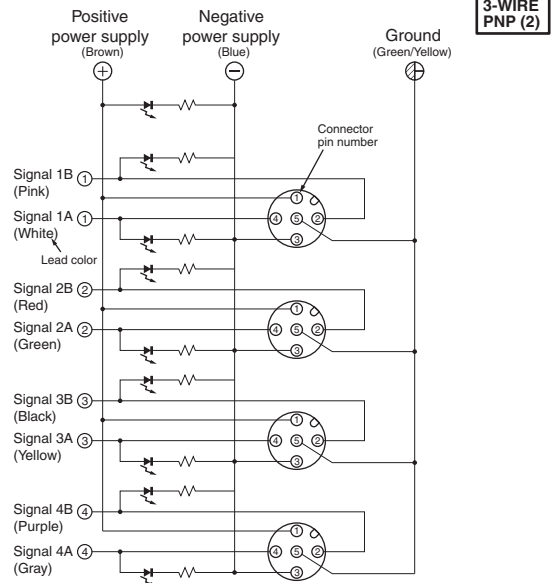

Mounting Dimensions

(Unit: mm)

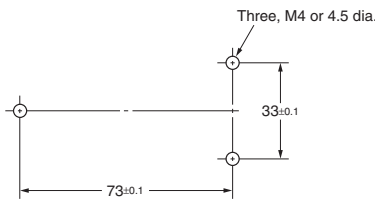

Note: The mounting dimensions are the same regardless of the number of ports.

Safety Precautions

Precautions for Correct Use

Do not use the Connectors in an atmosphere or environment that exceeds the specifications.

Connector Connection and Disconnection

- Mate the connectors according to the procedure.
- When mating Connectors, be sure to insert the plug all the way to the back of the socket before attempting to lock the Connectors.
- Do not use tools of any sort to mate the Connectors. Always use your hands. Pliers or other tools may damage the Connectors.
- When mating the Connectors to XS2 or other M12 Connectors, tighten the lock by hand to a torque of 0.39 to 0.49 N·m.
- Confirm in the catalog that sensors and actuators are applicable before using them.
- Always turn OFF the power supply before connecting or disconnecting connectors.
- Do not touch the mating surface of the connectors with wet hands.
- Wipe away any water around the connectors.
- Do not allow metal scraps or dust to enter the mating section.

Cable Lead Polarity

- Connect the cables leads using the correct polarity (Blue: Negative power supply, Brown: Positive power supply).
- If the polarity is not correct, the load may not operate or the operation indicator may not light.
- Always connect a load to the signal lines to operate a sensor or actuator.

Applicable Connectors

- Always mount a Waterproof Cover (XS2Z-22) or Dust Cover (XS2Z-15) to any unused connector on the Connector Terminal Box.

Power Supply and Operation Indicators

- The power supply indicator will be lit green while power is being supplied. The operation indicator will be lit red while the sensor or actuator is operating.
- The XW3D is for a DC sensor or actuator. Do not use it for an AC sensor or actuator.
- Connector Terminal Boxes are available with either 2-wire or 3-wire internal connections, as indicated on the case.

3-WIRE
NPN

2-WIRE

3-WIRE
PNP

3-WIRE
NPN (2)

3-WIRE
PNP (2)

E3X-CN

Ordering information

Type	Size	Features	Order code
Fiber amplifier connector	Special connector 17,8x10x15,1	4 wire; 2 m PVC cable	E3X-CN21
		3 wire; 2 m PVC cable	E3X-CN11
		2 wire slave cable; 2 m PVC	E3X-CN22 ^{*1}
		1 wire slave cable; 2 m PVC	E3X-CN12 ^{*1}
		M8 4-pin plug with 30 cm PVC cable	E3X-CN21-M3J-2 0.3M
		M12 4-pin plug with 30 cm PVC cable	E3X-CN21-M1J 0.3M

^{*1} Slave connectors can be used to reduce wiring effort. The setup requires 1 master amplifier with the slave amplifiers directly mounted attached. The power supply is then provided by the master amplifier via the clipped on slave connectors. For 4-wire masters use 2-wire slaves and for 3-wire masters 1-wire slaves.

Specifications

Rated current	2.5 A
Rated voltage	50V
Degree of protection	IP50 (EC 60529)
Ambient temperature	Groups of 1 or 2 amplifiers: -25 to 55°C
	Groups of 3 to 10 amplifiers: -25 to 50°C
	Groups of 11 to 16 amplifiers: -25 to 45°C

Materials

Housing	Polybutylene terephthalate (PBT)
Contacts	Phosphor bronze/ gold plated/ nickel

Pin arrangement

	Connector	Cable colour	
M8	1	brown	+
	2	orange/white	Output 2 or ext. input
	3	blue	-
M12	4	black	Output 1
		pink	Ext. Input

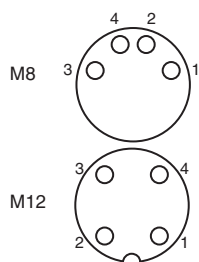

E3X-CN

Dimensions

Master connectors

E3X-CN21/E3X-CN11

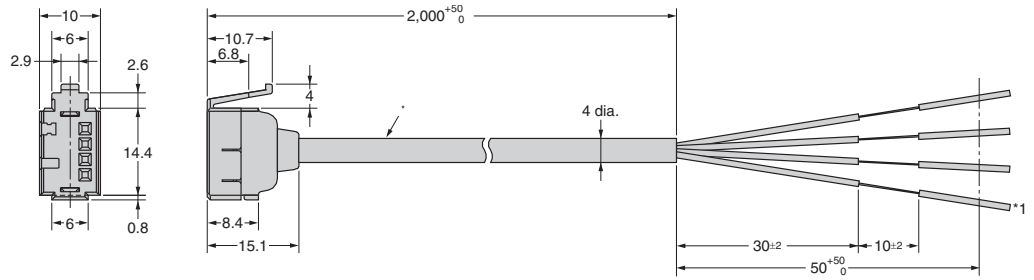

* E3X-CN21: 4-dia. vinyl-insulated round cable with 4 conductors (Conductor cross section: 0.2 mm², Insulator diameter: 1.1 mm)

*¹ Only E3X-CN21

Slave connectors

E3X-CN22/E3X-CN12

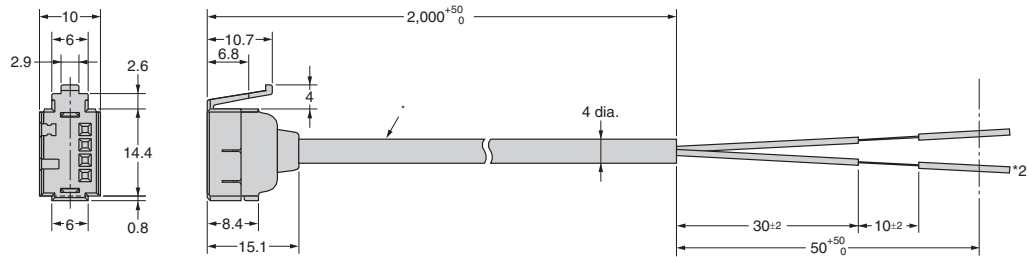

* E3X-CN21: 4-dia. vinyl-insulated round cable with 4 conductors (Conductor cross section: 0.2 mm², Insulator diameter: 1.1 mm)

*² Only E3X-CN22

Ordering information

Type	Size	Features	Applicable sensors	Order code
Pin connector for soldering	13×4×10.8	For dark on	EE-SX47/67	EE-1001
		For light on		EE-1001-1
Cable connector	13×4×13.5	standard cable		EE-1010 2M
		robotic cable		EE-1010-R 2M
	10×5.8×8	standard cable	EE-1017 1M	
		robotic cable	EE-1017-R 1M	
Cable connector for EE-SX91 pigtail versions	10×5.8×8	robotic cable	EE-SX91	EE-1016-R

Specifications

Rated voltage	5 to 24 VDC
Degree of protection	IP50 (IEC 60529)
Ambient temperature range	operating: -25 to 55°C
	storage: -30 to 80°C

Material

	EE-1001	EE-1010/EE-1016	EE-1017
Housing	Nylon		
Contacts	Phosphor bronze		
Cable	–	PVC 2 m	PVC 1 m (3 m are available on request)

Pin arrangement

	EE-1001, EE-1010		EE-1016		EE-1017	
1	+	Brown	+	Brown	+	Brown
2	L	Pink	output 2	White	1	Black
3	out	Black	–	Blue	2	White
4	–	Blue	output 1	Black	–	Blue

Note: For the connector EE-1001-1 the pins 1(+) and 2 (L) are short circuited

EE-1

Dimensions

Connector EE-1001

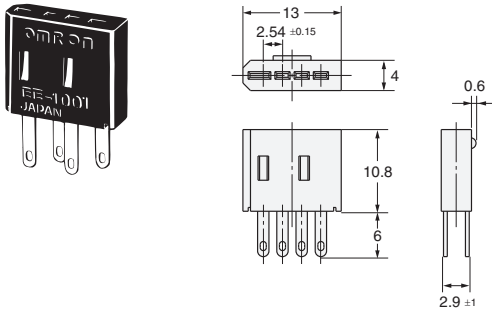

Connector (short-circuited between positive (+) and L terminals) EE-1001-1

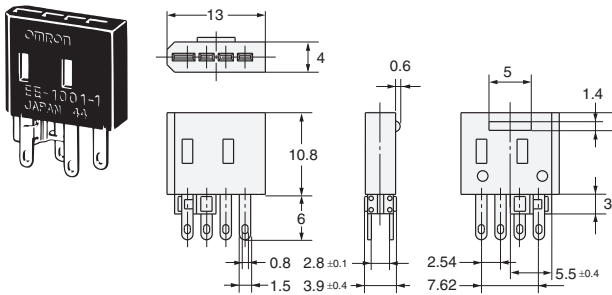

Connector with Cable EE-1010

Connector with Robot Cable EE-1010-R

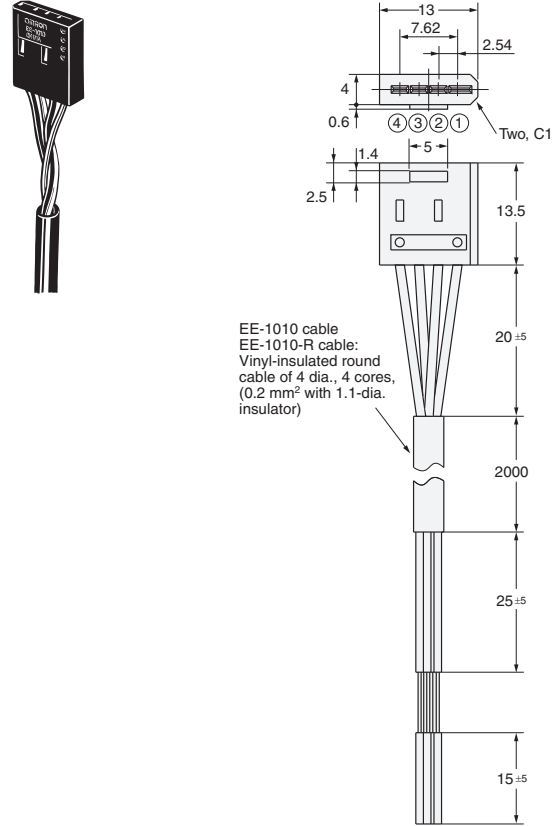

Connector with Robot Cable EE-1016-R

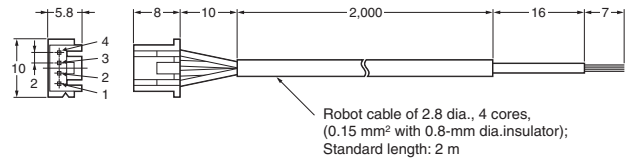

Connector with Robot Cable EE-1017-R

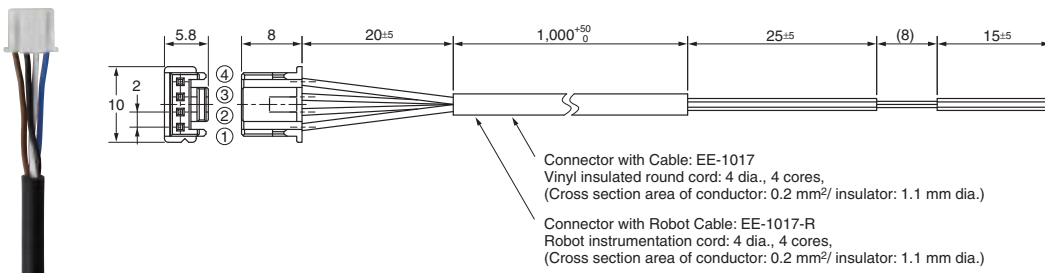

XS2

Name	Model		Appearance
Cable connectors with plugs (open end or connector end)	XS2W Plug connectors (Connector end)		
	XS2H Plug connectors (Open end)		
Connector Assembly Accessories (Crimping, Soldering, or Screw-on)	XS2F Crimp Tool (for Crimping Connectors)		
	XS2U Crimping pin (for XS2G/XS2C)		
	XW4Z Screwdriver (for Screw-on Connectors)		
Panel-mounting Connectors	XS2P Sockets (M12) XS3P Sockets (M8)		
	XS2M Plugs (M12) XS3M Plugs (M8)	Flange-mounting Plugs	
		Screw-mounting Plugs	
T-Joints and Y-Joints Used for branching and for daisy-chain connections.	XS2R T-Joint/Y-Joint Plug/Socket Connectors (M12) XS3R Y-Joint Plug/Socket Connectors (M8)		T-Joints
			Y-Joints
Dust covers Used to protect unused connector ports	XS2Z (M12) XS3Z (M8)		Connector plugs
			Connector covers

Note: For details on these products, contact your Omron representative

Read and Understand This Catalog

Please read and understand this catalog before purchasing the products. Please consult your OMRON representative if you have any questions or comments.

Warranty and Limitations of Liability

WARRANTY

OMRON's exclusive warranty is that the products are free from defects in materials and workmanship for a period of one year (or other period if specified) from date of sale by OMRON.

OMRON MAKES NO WARRANTY OR REPRESENTATION, EXPRESS OR IMPLIED, REGARDING NON-INFRINGEMENT, MERCHANTABILITY, OR FITNESS FOR PARTICULAR PURPOSE OF THE PRODUCTS. ANY BUYER OR USER ACKNOWLEDGES THAT THE BUYER OR USER ALONE HAS DETERMINED THAT THE PRODUCTS WILL SUITABLY MEET THE REQUIREMENTS OF THEIR INTENDED USE. OMRON DISCLAIMS ALL OTHER WARRANTIES, EXPRESS OR IMPLIED.

LIMITATIONS OF LIABILITY

OMRON SHALL NOT BE RESPONSIBLE FOR SPECIAL, INDIRECT, OR CONSEQUENTIAL DAMAGES, LOSS OF PROFITS OR COMMERCIAL LOSS IN ANY WAY CONNECTED WITH THE PRODUCTS, WHETHER SUCH CLAIM IS BASED ON CONTRACT, WARRANTY, NEGLIGENCE, OR STRICT LIABILITY.

In no event shall the responsibility of OMRON for any act exceed the individual price of the product on which liability is asserted.

IN NO EVENT SHALL OMRON BE RESPONSIBLE FOR WARRANTY, REPAIR, OR OTHER CLAIMS REGARDING THE PRODUCTS UNLESS OMRON'S ANALYSIS CONFIRMS THAT THE PRODUCTS WERE PROPERLY HANDLED, STORED, INSTALLED, AND MAINTAINED AND NOT SUBJECT TO CONTAMINATION, ABUSE, MISUSE, OR INAPPROPRIATE MODIFICATION OR REPAIR.

Application Considerations

SUITABILITY FOR USE

OMRON shall not be responsible for conformity with any standards, codes, or regulations that apply to the combination of products in the customer's application or use of the products.

At the customer's request, OMRON will provide applicable third party certification documents identifying ratings and limitations of use that apply to the products. This information by itself is not sufficient for a complete determination of the suitability of the products in combination with the end product, machine, system, or other application or use.

The following are some examples of applications for which particular attention must be given. This is not intended to be an exhaustive list of all possible uses of the products, nor is it intended to imply that the uses listed may be suitable for the products:

- Outdoor use, uses involving potential chemical contamination or electrical interference, or conditions or uses not described in this catalog.
- Nuclear energy control systems, combustion systems, railroad systems, aviation systems, medical equipment, amusement machines, vehicles, safety equipment, and installations subject to separate industry or government regulations.
- Systems, machines, and equipment that could present a risk to life or property.

Please know and observe all prohibitions of use applicable to the products.

NEVER USE THE PRODUCTS FOR AN APPLICATION INVOLVING SERIOUS RISK TO LIFE OR PROPERTY WITHOUT ENSURING THAT THE SYSTEM AS A WHOLE HAS BEEN DESIGNED TO ADDRESS THE RISKS, AND THAT THE OMRON PRODUCTS ARE PROPERLY RATED AND INSTALLED FOR THE INTENDED USE WITHIN THE OVERALL EQUIPMENT OR SYSTEM.

PROGRAMMABLE PRODUCTS

OMRON shall not be responsible for the user's programming of a programmable product, or any consequence thereof.

Disclaimers

CHANGE IN SPECIFICATIONS

Product specifications and accessories may be changed at any time based on improvements and other reasons.

It is our practice to change model numbers when published ratings or features are changed, or when significant construction changes are made. However, some specifications of the products may be changed without any notice. When in doubt, special model numbers may be assigned to fix or establish key specifications for your application on your request. Please consult with your OMRON representative at any time to confirm actual specifications of purchased products.

DIMENSIONS AND WEIGHTS

Dimensions and weights are nominal and are not to be used for manufacturing purposes, even when tolerances are shown.

PERFORMANCE DATA

Performance data given in this catalog is provided as a guide for the user in determining suitability and does not constitute a warranty. It may represent the result of OMRON's test conditions, and the users must correlate it to actual application requirements. Actual performance is subject to the OMRON Warranty and Limitations of Liability.

ERRORS AND OMISSIONS

The information in this document has been carefully checked and is believed to be accurate; however, no responsibility is assumed for clerical, typographical, or proofreading errors, or omissions.

Cat. No. E96E-EN-05

In the interest of product improvement, specifications are subject to change without notice.

OMRON EUROPE B.V.

Wegalaan 67-69,
NL-2132 JD, Hoofddorp,
The Netherlands
Phone: +31 23 568 13 00
Fax: +31 23 568 13 88
industrial.omron.eu