

Cylindrical Proximity Sensor E2A

Safe Mounting with Greater Sensing Distance

- Ensures a sensing distance approximately 1.5 to 2 times larger than that of any conventional OMRON Sensor.
- Problems such as the collision of workpieces are eliminated.
- Full range of standard sizes (M8, M12, M18 and M30; both long and short barrels)
- Modular construction simplifies customization.

<READ AND UNDERSTAND THIS CATALOG>

Please read and understand this catalog before purchasing the products. Please consult your OMRON representative if you have any questions or comments.

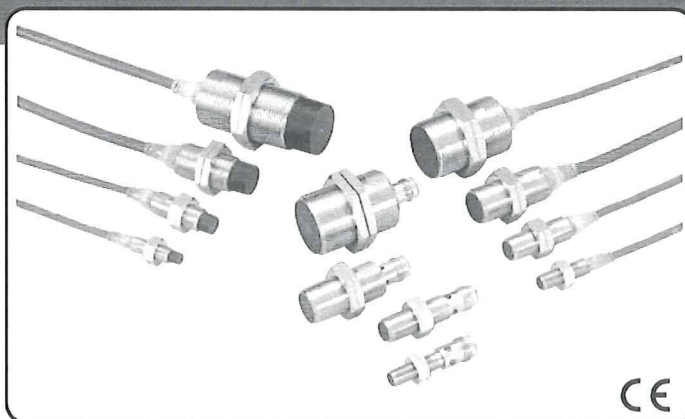

Ordering Information

| Size | | Sensing distance | Connection | Body material | Thread length (overall length) | Output configuration | Operation mode NO | Operation mode NC |
|------|--------------|------------------|----------------------|-----------------|--------------------------------|----------------------|----------------------|----------------------|
| M8 | Shielded | 2.0 mm | Pre-wired | Stainless steel | 27 (40) | PNP | E2A-S08KS02-WP-B1 2M | E2A-S08KS02-WP-B2 2M |
| | | | | | 49 (62) | NPN | E2A-S08KS02-WP-C1 2M | E2A-S08KS02-WP-C2 2M |
| | | | | | 27 (43) | PNP | E2A-S08LS02-M1-B1 | E2A-S08LS02-M1-B2 |
| | | | | | 49 (65) | NPN | E2A-S08LS02-M1-C1 | E2A-S08LS02-M1-C2 |
| | | | M12 connector | Stainless steel | 27 (43) | PNP | E2A-S08KS02-M1-B1 | E2A-S08KS02-M1-B2 |
| | | | | | 49 (65) | NPN | E2A-S08KS02-M1-C1 | E2A-S08KS02-M1-C2 |
| | | | | | 27 (43) | PNP | E2A-S08LS02-M1-B1 | E2A-S08LS02-M1-B2 |
| | | | | | 49 (65) | NPN | E2A-S08LS02-M1-C1 | E2A-S08LS02-M1-C2 |
| | | | M8 connector (3-pin) | Stainless steel | 27 (39) | PNP | E2A-S08KS02-M5-B1 | E2A-S08KS02-M5-B2 |
| | | | | | 49 (61) | NPN | E2A-S08KS02-M5-C1 | E2A-S08KS02-M5-C2 |
| | | | | | 27 (39) | PNP | E2A-S08LS02-M5-B1 | E2A-S08LS02-M5-B2 |
| | | | | | 49 (61) | NPN | E2A-S08LS02-M5-C1 | E2A-S08LS02-M5-C2 |
| | Non-shielded | 4.0 mm | Pre-wired | Stainless steel | 27 (40) | PNP | E2A-S08KN04-WP-B1 2M | E2A-S08KN04-WP-B2 2M |
| | | | | | 49 (62) | NPN | E2A-S08KN04-WP-C1 2M | E2A-S08KN04-WP-C2 2M |
| | | | | | 27 (43) | PNP | E2A-S08LN04-M1-B1 | E2A-S08LN04-M1-B2 |
| | | | | | 49 (65) | NPN | E2A-S08LN04-M1-C1 | E2A-S08LN04-M1-C2 |
| | | | M12 connector | Stainless steel | 27 (43) | PNP | E2A-S08KN04-M1-B1 | E2A-S08KN04-M1-B2 |
| | | | | | 49 (65) | NPN | E2A-S08KN04-M1-C1 | E2A-S08KN04-M1-C2 |
| | | | | | 27 (43) | PNP | E2A-S08LN04-M1-B1 | E2A-S08LN04-M1-B2 |
| | | | | | 49 (65) | NPN | E2A-S08LN04-M1-C1 | E2A-S08LN04-M1-C2 |
| | | | M8 connector (3-pin) | Stainless steel | 27 (39) | PNP | E2A-S08KN04-M5-B1 | E2A-S08KN04-M5-B2 |
| | | | | | 49 (61) | NPN | E2A-S08KN04-M5-C1 | E2A-S08KN04-M5-C2 |
| | | | | | 27 (39) | PNP | E2A-S08LN04-M5-B1 | E2A-S08LN04-M5-B2 |
| | | | | | 49 (61) | NPN | E2A-S08LN04-M5-C1 | E2A-S08LN04-M5-C2 |

| Size | | Sensing distance | Connection | Body material | Thread length (overall length) | Output configuration | Operation mode NO | Operation mode NC | |
|------|--------------|------------------|---------------|---------------|--------------------------------|----------------------|----------------------|----------------------|----------------------|
| M12 | Shielded | 4.0 mm | Pre-wired | Brass | 34 (50) | PNP | E2A-M12KS04-WP-B1 2M | E2A-M12KS04-WP-B2 2M | |
| | | | | | | NPN | E2A-M12KS04-WP-C1 2M | E2A-M12KS04-WP-C2 2M | |
| | | | | | 56 (72) | PNP | E2A-M12LS04-WP-B1 2M | E2A-M12LS04-WP-B2 2M | |
| | | | | | | NPN | E2A-M12LS04-WP-C1 2M | E2A-M12LS04-WP-C2 2M | |
| | | | M12 connector | Brass | 34 (48) | PNP | E2A-M12KS04-M1-B1 | E2A-M12KS04-M1-B2 | |
| | | | | | | NPN | E2A-M12KS04-M1-C1 | E2A-M12KS04-M1-C2 | |
| | | | | | 56 (70) | PNP | E2A-M12LS04-M1-B1 | E2A-M12LS04-M1-B2 | |
| | | | | | | NPN | E2A-M12LS04-M1-C1 | E2A-M12LS04-M1-C2 | |
| | Non-shielded | 8.0 mm | Pre-wired | Brass | 34 (50) | PNP | E2A-M12KN08-WP-B1 2M | E2A-M12KN08-WP-B2 2M | |
| | | | | | | NPN | E2A-M12KN08-WP-C1 2M | E2A-M12KN08-WP-C2 2M | |
| | | | | | 56 (72) | PNP | E2A-M12LN08-WP-B1 2M | E2A-M12LN08-WP-B2 2M | |
| | | | | | | NPN | E2A-M12LN08-WP-C1 2M | E2A-M12LN08-WP-C2 2M | |
| | | | M12 connector | Brass | 34 (48) | PNP | E2A-M12KN08-M1-B1 | E2A-M12KN08-M1-B2 | |
| | | | | | | NPN | E2A-M12KN08-M1-C1 | E2A-M12KN08-M1-C2 | |
| | | | | | 56 (70) | PNP | E2A-M12LN08-M1-B1 | E2A-M12LN08-M1-B2 | |
| | | | | | | NPN | E2A-M12LN08-M1-C1 | E2A-M12LN08-M1-C2 | |
| M18 | Shielded | 8.0 mm | Pre-wired | Brass | 39 (59) | PNP | E2A-M18KS08-WP-B1 2M | E2A-M18KS08-WP-B2 2M | |
| | | | | | | NPN | E2A-M18KS08-WP-C1 2M | E2A-M18KS08-WP-C2 2M | |
| | | | | | 61 (81) | PNP | E2A-M18LS08-WP-B1 2M | E2A-M18LS08-WP-B2 2M | |
| | | | | | | NPN | E2A-M18LS08-WP-C1 2M | E2A-M18LS08-WP-C2 2M | |
| | | | M12 connector | Brass | 39 (53) | PNP | E2A-M18KS08-M1-B1 | E2A-M18KS08-M1-B2 | |
| | | | | | | NPN | E2A-M18KS08-M1-C1 | E2A-M18KS08-M1-C2 | |
| | | | | | 61 (75) | PNP | E2A-M18LS08-M1-B1 | E2A-M18LS08-M1-B2 | |
| | | | | | | NPN | E2A-M18LS08-M1-C1 | E2A-M18LS08-M1-C2 | |
| | Non-shielded | 16.0 mm | Pre-wired | Brass | 39 (59) | PNP | E2A-M18KN16-WP-B1 2M | E2A-M18KN16-WP-B2 2M | |
| | | | | | | NPN | E2A-M18KN16-WP-C1 2M | E2A-M18KN16-WP-C2 2M | |
| | | | | | 61 (81) | PNP | E2A-M18LN16-WP-B1 2M | E2A-M18LN16-WP-B2 2M | |
| | | | | | | NPN | E2A-M18LN16-WP-C1 2M | E2A-M18LN16-WP-C2 2M | |
| | | | M12 connector | Brass | 39 (53) | PNP | E2A-M18KN16-M1-B1 | E2A-M18KN16-M1-B2 | |
| | | | | | | NPN | E2A-M18KN16-M1-C1 | E2A-M18KN16-M1-C2 | |
| | | | | | 61 (75) | PNP | E2A-M18LN16-M1-B1 | E2A-M18LN16-M1-B2 | |
| | | | | | | NPN | E2A-M18LN16-M1-C1 | E2A-M18LN16-M1-C2 | |
| M30 | Shielded | 15.0 mm | Pre-wired | Brass | 44 (64) | PNP | E2A-M30KS15-WP-B1 2M | E2A-M30KS15-WP-B2 2M | |
| | | | | | | NPN | E2A-M30KS15-WP-C1 2M | E2A-M30KS15-WP-C2 2M | |
| | | | | | 66 (86) | PNP | E2A-M30LS15-WP-B1 2M | E2A-M30LS15-WP-B2 2M | |
| | | | | | | NPN | E2A-M30LS15-WP-C1 2M | E2A-M30LS15-WP-C2 2M | |
| | | | M12 connector | Brass | 44 (58) | PNP | E2A-M30KS15-M1-B1 | E2A-M30KS15-M1-B2 | |
| | | | | | | NPN | E2A-M30KS15-M1-C1 | E2A-M30KS15-M1-C2 | |
| | | | | | 66 (80) | PNP | E2A-M30LS15-M1-B1 | E2A-M30LS15-M1-B2 | |
| | | | | | | NPN | E2A-M30LS15-M1-C1 | E2A-M30LS15-M1-C2 | |
| | Non-shielded | 20.0 mm | Pre-wired | Brass | 44 (64) (See note.) | PNP | E2A-M30KN20-WP-B1 2M | E2A-M30KN20-WP-B2 2M | |
| | | | | | | NPN | E2A-M30KN20-WP-C1 2M | E2A-M30KN20-WP-C2 2M | |
| | | | | | 30.0 mm | 66 (86) | PNP | E2A-M30LN30-WP-B1 2M | E2A-M30LN30-WP-B2 2M |
| | | | | | | | NPN | E2A-M30LN30-WP-C1 2M | E2A-M30LN30-WP-C2 2M |
| | | 20.0 mm | M12 connector | Brass | 44 (58) (See note.) | PNP | E2A-M30KN20-M1-B1 | E2A-M30KN20-M1-B2 | |
| | | | | | | NPN | E2A-M30KN20-M1-C1 | E2A-M30KN20-M1-C2 | |
| | | | | | 30.0 mm | 66 (80) | PNP | E2A-M30LN30-M1-B1 | E2A-M30LN30-M1-B2 |
| | | | | | | | NPN | E2A-M30LN30-M1-C1 | E2A-M30LN30-M1-C2 |

Note: M30 non-shielded Models with double sensing distance and short barrels cannot be mounted due to the necessary separation distance from the surrounding metal. Standard sensing models are thus available.

■ Model Number Legend

E2A□-□□□□□□-□-□□□□□□
 1 2 3 4 5 6 7 8 9 10 11 12

Example: E2A-M12LS04-M1-B1 Standard, M12, long barrel, shielded, Sn=4 mm, M12 connector, PNP-NO
 E2A-M08KN04-WP-B1 5M Standard, M8, short barrel, non-shielded, Sn=4 mm, pre-wired PVC cable, PNP-NO, cable length=5 m

1. Basic name

E2A

2. Sensing technology

Blank: Standard double distance

3. Housing shape and material

M: Cylindrical, metric threaded, brass

S: Cylindrical, metric threaded, stainless steel

4. Housing size

08: 8 mm

12: 12 mm

18: 18 mm

30: 30 mm

5. Barrel length

K: Standard length

L: Long body

6. Shield

S: Shielded

N: Non-shielded

7. Sensing distance

Numeral: Sensing distance: e.g. 02=2 mm, 16=16 mm

8. Kind of connection

WP: Pre-wired, PVC

M1: M12 connector (4-pole)

M3: M8 connector (4-pole)

M5: M8 connector (3-pole)

9. Power source and output

B: DC, 3-wire, PNP open collector

C: DC, 3-wire, NPN open collector

D: DC, 2-wire

E: DC, 3-wire, NPN voltage output

F: DC, 3-wire, PNP voltage output

10. Operation mode

1: Normally open (NO)

2: Normally closed (NC)

11. Specials (e.g., cable material, oscillating frequency)

12. Cable length

Blank: Connector type

Numeral: Cable type

Specifications

DC 3-wire Models

| Item | Size Type | M8 | | M12 | |
|--|----------------------------|--|--|--|--|
| | | Shielded | Non-shielded | Shielded | Non-shielded |
| | | E2A-M08□S02-M1-B1 E2A-M08□S02-M1-B2 E2A-M08□S02-M1-C1 E2A-M08□S02-M1-C2 E2A-S08□S02-□□-B1 E2A-S08□S02-□□-B2 E2A-S08□S02-□□-C1 E2A-S08□S02-□□-C2 | E2A-M08□N04-M1-B1 E2A-M08□N04-M1-B2 E2A-M08□N04-M1-C1 E2A-M08□N04-M1-C2 E2A-S08□N04-□□-B1 E2A-S08□N04-□□-B2 E2A-S08□N04-□□-C1 E2A-S08□N04-□□-C2 | E2A-M12□S04-□□-B1 E2A-M12□S04-□□-B2 E2A-M12□S04-□□-C1 E2A-M12□S04-□□-C2 | E2A-M12□N08-□□-B1 E2A-M12□N08-□□-B2 E2A-M12□N08-□□-C1 E2A-M12□N08-□□-C2 |
| Sensing distance | | 2 mm ± 10% | 4 mm ± 10% | 4 mm ± 10% | 8 mm ± 10% |
| Setting distance | | 0 to 1.6 mm | 0 to 3.2 mm | 0 to 3.2 mm | 0 to 6.4 mm |
| Differential travel | | 10% max. of sensing distance | | | |
| Target | | Ferrous metal (The sensing distance decreases with non-ferrous metal.) | | | |
| Standard target (mild steel ST37) | | 8×8×1 mm | 12×12×1 mm | 12×12×1 mm | 24×24×1 mm |
| Response frequency (See note 1.) | | 1,500 Hz | 1,000 Hz | 1,000 Hz | 800 Hz |
| Power supply voltage (operating voltage range) | | 12 to 24 VDC. Ripple (p-p): 10% max. (10 to 32 VDC) | | | |
| Current consumption (DC 3-wire) | | 10 mA max. | | | |
| Output type | | -B models: PNP open collector -C models: NPN open collector | | | |
| Control output | Load current (See note 2.) | 200 mA max. (32 VDC max.) | | | |
| | Residual voltage | 2 V max. (under load current of 200 mA with cable length of 2 m) | | | |
| Indicator | | Operation indicator (Yellow LED) | | | |
| Operation mode (with sensing object approaching) | | -B1/-C1 models: NO -B2/-C2 models: NC For details, refer to the timing charts. | | | |
| Protection circuit | | Power source circuit reverse polarity protection, Surge suppressor, Short-circuit protection | | Output reverse polarity protection, Power source circuit reverse polarity protection, Surge suppressor, Short-circuit protection | |
| Ambient air temperature | | Operating: -40°C to 70°C, Storage: -40°C to 85°C (with no icing or condensation) | | | |
| Temperature influence (See note 2.) | | ±10% max. of sensing distance at 23°C within temperature range of -25°C to 70°C ±15% max. of sensing distance at 23°C within temperature range of -40°C to 70°C | | | |
| Ambient humidity | | Operating: 35% to 95%, Storage: 35% to 95% | | | |
| Voltage influence | | ±1% max. of sensing distance in rated voltage range ±15% | | | |
| Insulation resistance | | 50 MΩ min. (at 500 VDC) between current carry parts and case | | | |
| Dielectric strength | | 1,000 VAC at 50/60 Hz for 1 min between current carry parts and case | | | |
| Vibration resistance | | 10 to 55 Hz, 1.5-mm double amplitude for 2 hours each in X, Y and Z directions | | | |
| Shock resistance | | 500 m/s ² , 10 times each in X, Y and Z directions | | 1,000 m/s ² , 10 times each in X, Y and Z directions | |
| Standard and listings (See note 3.) | | IEC60529: IP67, Degree of protection EN60947-5-2: EMC | | | |
| Connection method | | -WP models: Pre-wired models (Standard length: 2 m) -M1 models: M12 4-pin connector models -M5 models: M8 3-pin connector models | | | |
| Weight (packaged) | Pre-wired model | Approx. 65 g | | Approx. 85 g | |
| | M12 connector model | M12 connector models: Approx. 20 g M8 connector models: Approx. 15 g | | Approx. 35 g | |
| Material | Case | Stainless steel or brass-nickel plated | | Brass-nickel plated | |
| | Sensing surface | PBT | | | |
| | Cable | PVC | | | |
| | Clamping nut | Brass-nickel plated | | | |

- Note 1.** The response frequency is an average value. Measurement conditions are as follows: standard target, a distance of twice the standard target distance between targets, and a setting distance of half the sensing distance.
- 2.** When using any model at an ambient temperature between -40°C and -25°C and a power voltage between 30 and 32 VDC, use a load current of 100 mA max.,
- 3.** For USA and CANADA : use class 2 circuit only.

■ DC 3-wire Models

| Item | Size Type | M18 | | M30 | | | |
|--|--|--|--|--|--|--|------------|
| | | Shielded | Non-shielded | Shielded | Non-shielded | Non-shielded | |
| | | E2A-M18□S08-□□-B1 E2A-M18□S08-□□-B2 E2A-M18□S08-□□-C1 E2A-M18□S08-□□-C2 | E2A-M18□N16-□□-B1 E2A-M18□N16-□□-B2 E2A-M18□N16-□□-C1 E2A-M18□N16-□□-C2 | E2A-M30□S15-□□-B1 E2A-M30□S15-□□-B2 E2A-M30□S15-□□-C1 E2A-M30□S15-□□-C2 | E2A-M30KN20-□□-B1 E2A-M30KN20-□□-B2 E2A-M30KN20-□□-C1 E2A-M30KN20-□□-C2 | E2A-M30LN30-□□-B1 E2A-M30LN30-□□-B2 E2A-M30LN30-□□-C1 E2A-M30LN30-□□-C2 | |
| Sensing distance | 8 mm±10% | | 16 mm±10% | | 15 mm±10% | 20 mm±10% | 30 mm±10% |
| Setting distance | 0 to 6.4 mm | | 0 to 12.8 mm | | 0 to 12 mm | 0 to 16 mm | 0 to 24 mm |
| Differential travel | 10% max. of sensing distance | | | | | | |
| Target | Ferrous metal (The sensing distance decreases with non-ferrous metal.) | | | | | | |
| Standard target (mild steel ST37) | 24×24×1 mm | | 48×48×1 mm | | 45×45×1 mm | 60×60×1 mm | 90×90×1 mm |
| Response frequency (See note 1.) | 500 Hz | | 400 Hz | | 250 Hz | 100 Hz | 100 Hz |
| Power supply voltage (operating voltage range) | 12 to 24 VDC. Ripple (p-p): 10% max. (10 to 32 VDC) | | | | | | |
| Current consumption (DC 3-wire) | 10 mA max. | | | | | | |
| Output type | -B models: PNP open collector -C models: NPN open collector | | | | | | |
| Control output | Load current (See note 2.) | 200 mA max. (32 VDC max.) | | | | | |
| | Residual voltage | 2 V max. (under load current of 200 mA with cable length of 2 m) | | | | | |
| Indicator | Operation indicator (Yellow LED) | | | | | | |
| Operation mode (with sensing object approaching) | -B1/-C1 models: NO -B2/-C2 models: NC For details, refer to the timing charts. | | | | | | |
| Protection circuit | Output reverse polarity protection, Power source circuit reverse polarity protection, Surge suppressor, Short-circuit protection | | | | | | |
| Ambient air temperature | Operating: -40°C to 70°C, Storage: -40°C to 85°C (with no icing or condensation) | | | | | | |
| Temperature influence (See note 2.) | ±10% max. of sensing distance at 23°C within temperature range of -25°C to 70°C ±15% max. of sensing distance at 23°C within temperature range of -40°C to 70°C | | | | | | |
| Ambient humidity | Operating: 35% to 95%, Storage: 35% to 95% | | | | | | |
| Voltage influence | ±1% max. of sensing distance in rated voltage range ±15% | | | | | | |
| Insulation resistance | 50 MΩ min. (at 500 VDC) between current carry parts and case | | | | | | |
| Dielectric strength | 1,000 VAC at 50/60 Hz for 1 min between current carry parts and case | | | | | | |
| Vibration resistance | 10 to 55 Hz, 1.5-mm double amplitude for 2 hours each in X, Y and Z directions | | | | | | |
| Shock resistance | 1,000 m/s ² , 10 times each in X, Y and Z directions | | | | | | |
| Standard and listings (See note 3.) | IEC60529: IP67, Degree of protection EN60947-5-2: EMC | | | | | | |
| Connection method | -WP models: Pre-wired models (Standard length: 2 m) -M1 models: M12 4-pin connector models -M5 models: M8 3-pin connector models | | | | | | |
| Weight (packaged) | Pre-wired model | Approx. 160 g | | Approx. 280 g | Approx. 280 g | Approx. 370 g | |
| | M12 connector model | Approx. 70 g | | Approx. 200 g | Approx. 200 g | Approx. 260 g | |
| Material | Case | Brass-nickel plated | | | | | |
| | Sensing surface | PBT | | | | | |
| | Cable | PVC | | | | | |
| | Clamping nut | Brass-nickel plated | | | | | |

Note 1. The response frequency is an average value. Measurement conditions are as follows: standard target, a distance of twice the standard target distance between targets, and a setting distance of half the sensing distance.

2. When using any model at an ambient temperature between -40°C and -25°C and a power voltage between 30 and 32 VDC, use a load current of 100 mA max.

3. For USA and CANADA : use class 2 circuit only.

Engineering Data

Operating Range (Typical)

Shielded Models

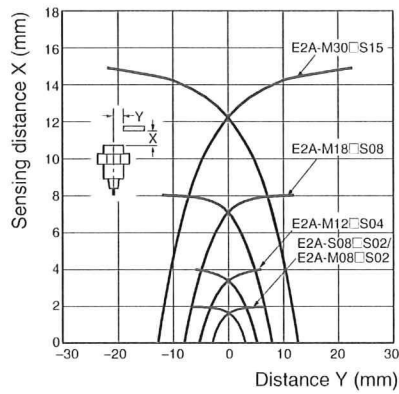

Non-shielded Models

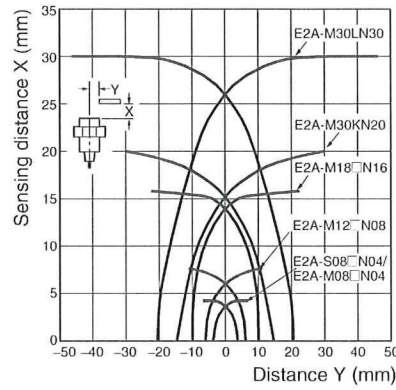

Influence of Sensing Object Size and Materials

Shielded Models

E2A-S08□S02/M08□S02

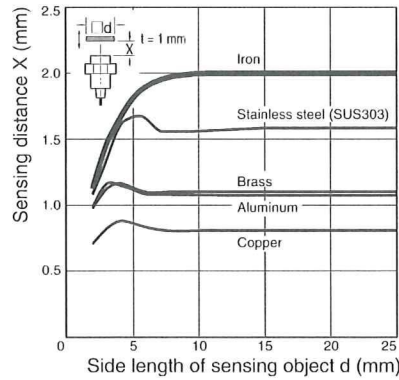

E2A-M12□S04

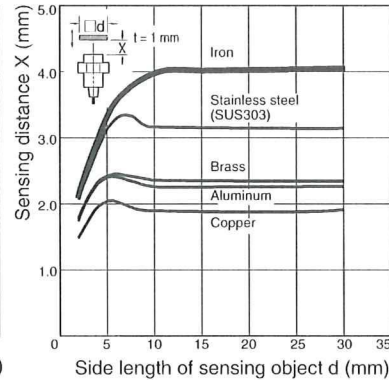

E2A-M18□S08

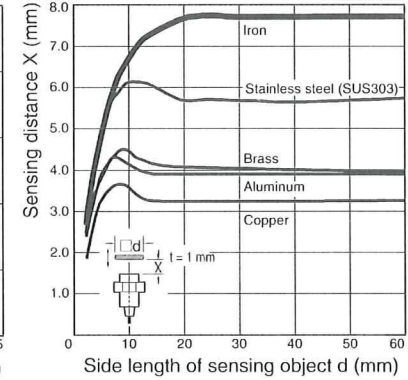

E2A-M30□S15

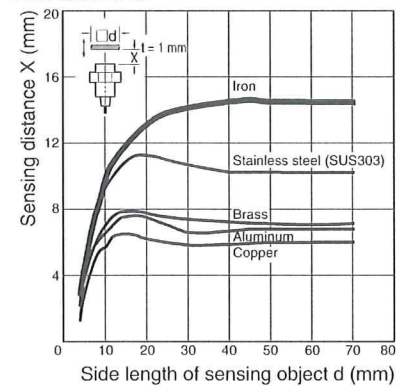

Non-shielded Models

E2A-S08□N04/M08□N04

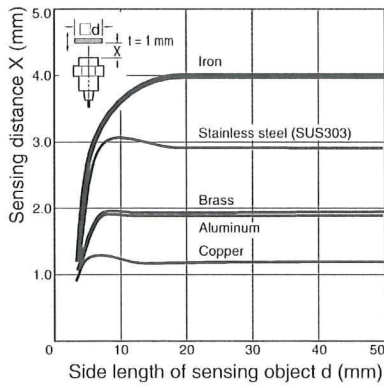

E2A-M12□N08

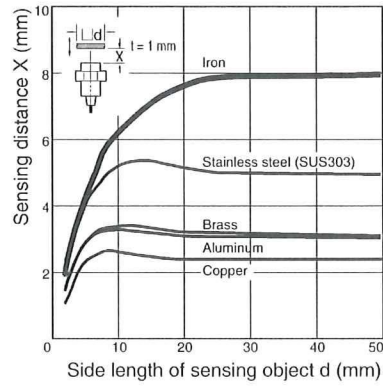

E2A-M18□N16

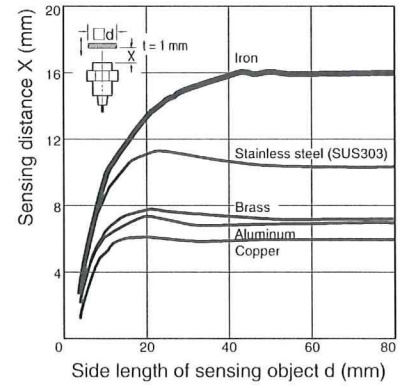

E2A-M30KN20

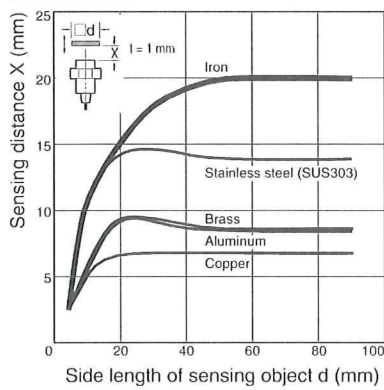

E2A-M30LN30

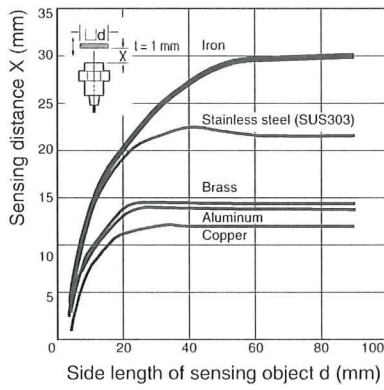

Operation

PNP Output

| Operation mode | Model | Timing chart | Output circuit |
|----------------|--------------------|--------------|---|
| NO | E2A-□-□- B1 | | <p>Note 1: With M8 connector models, there is no output reverse polarity protection diode.</p> <p>M12 Connector Pin Arrangement (See note 2.)</p> <p>M8 Connector Pin Arrangement</p> <p>Note 2: Terminal 2 of the M12 connector is not used.</p> |
| NC | E2A-□-□- B2 | | <p>Note 1: With M8 connector models, there is no output reverse polarity protection diode.</p> <p>M12 Connector Pin Arrangement (See note 2.)</p> <p>M8 Connector Pin Arrangement</p> <p>Note 2: Terminal 4 of the M12 connector is not used.</p> |

Dimensions

Note: All units are in millimeters unless otherwise indicated.

Pre-wired Models (Shielded)



E2A-S08KS02-WP-□□

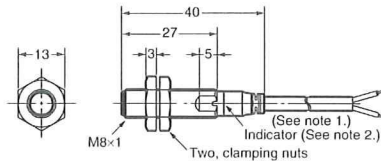

Note 1. 4-dia. vinyl-insulated round cable with 3 conductors (conductor cross section: 0.3 mm²; insulator diameter: 1.3 mm); standard length: 2 m
 2. Operation indicator (yellow)

E2A-M12KS04-WP-□□

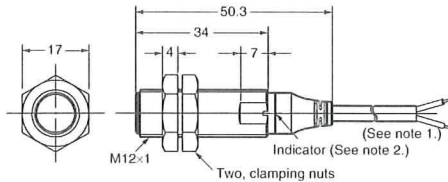

Note 1. 4-dia. vinyl-insulated round cable with 3 conductors (conductor cross section: 0.3 mm²; insulator diameter: 1.3 mm); standard length: 2 m
 2. Operation indicator (yellow)

E2A-M18KS08-WP-□□

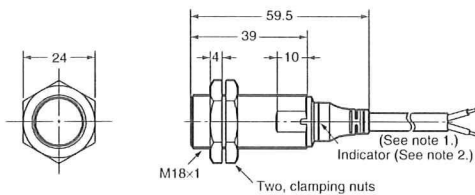

Note 1. 4-dia. vinyl-insulated round cable with 3 conductors (conductor cross section: 0.3 mm²; insulator diameter: 1.3 mm); standard length: 2 m
 2. Operation indicator (yellow)

E2A-M30KS15-WP-□□

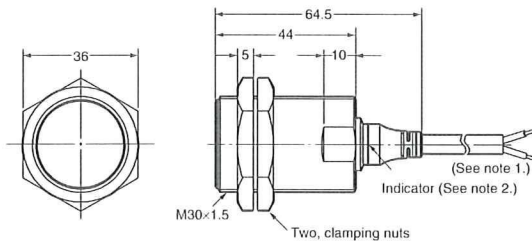

Note 1. 4-dia. vinyl-insulated round cable with 3 conductors (conductor cross section: 0.3 mm²; insulator diameter: 1.3 mm); standard length: 2 m
 2. Operation indicator (yellow)

Pre-wired Models (Non-shielded)



E2A-S08KN04-WP-□□

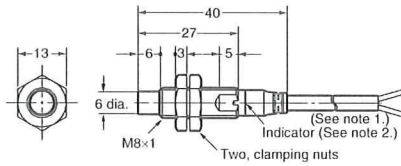

Note 1. 4-dia. vinyl-insulated round cable with 3 conductors (conductor cross section: 0.3 mm²; insulator diameter: 1.3 mm); standard length: 2 m
 2. Operation indicator (yellow)

E2A-M12KN08-WP-□□

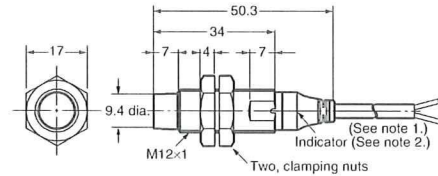

Note 1. 4-dia. vinyl-insulated round cable with 3 conductors (conductor cross section: 0.3 mm²; insulator diameter: 1.3 mm); standard length: 2 m
 2. Operation indicator (yellow)

E2A-M18KN16-WP-□□

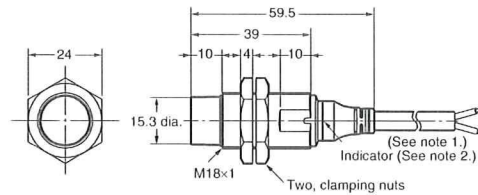

Note 1. 4-dia. vinyl-insulated round cable with 3 conductors (conductor cross section: 0.3 mm²; insulator diameter: 1.3 mm); standard length: 2 m
 2. Operation indicator (yellow)

E2A-M30KN20-WP-□□

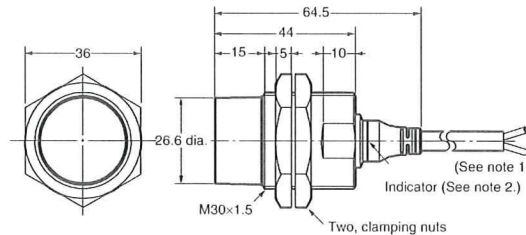

Note 1. 4-dia. vinyl-insulated round cable with 3 conductors (conductor cross section: 0.3 mm²; insulator diameter: 1.3 mm); standard length: 2 m
 2. Operation indicator (yellow)

E2A-S08LS02-WP-□□

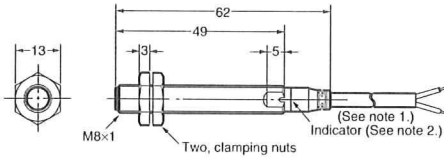

Note 1. 4-dia. vinyl-insulated round cable with 3 conductors (conductor cross section: 0.3 mm²; insulator diameter: 1.3 mm); standard length: 2 m
2. Operation indicator (yellow)

E2A-S08LN04-WP-□□

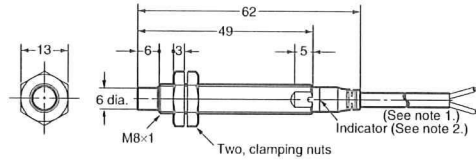

Note 1. 4-dia. vinyl-insulated round cable with 3 conductors (conductor cross section: 0.3 mm²; insulator diameter: 1.3 mm); standard length: 2 m
2. Operation indicator (yellow)

E2A-M12LS04-WP-□□

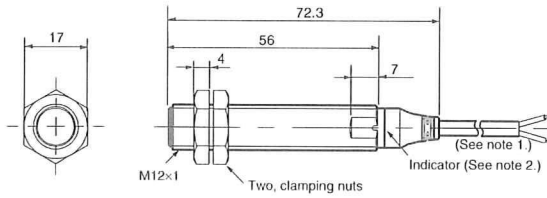

Note 1. 4-dia. vinyl-insulated round cable with 3 conductors (conductor cross section: 0.3 mm²; insulator diameter: 1.3 mm); standard length: 2 m
2. Operation indicator (yellow)

E2A-M12LN08-WP-□□

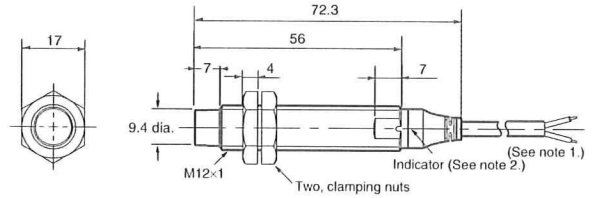

Note 1. 4-dia. vinyl-insulated round cable with 3 conductors (conductor cross section: 0.3 mm²; insulator diameter: 1.3 mm); standard length: 2 m
2. Operation indicator (yellow)

E2A-M18LS08-WP-□□

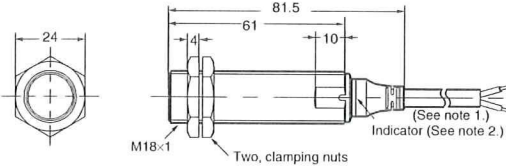

Note 1. 4-dia. vinyl-insulated round cable with 3 conductors (conductor cross section: 0.3 mm²; insulator diameter: 1.3 mm); standard length: 2 m
2. Operation indicator (yellow)

E2A-M18LN16-WP-□□

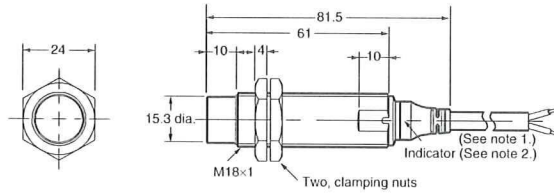

Note 1. 4-dia. vinyl-insulated round cable with 3 conductors (conductor cross section: 0.3 mm²; insulator diameter: 1.3 mm); standard length: 2 m
2. Operation indicator (yellow)

E2A-M30LS15-WP-□□

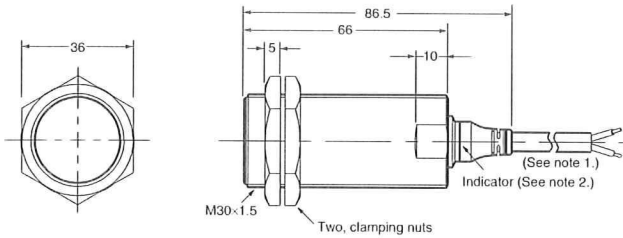

Note 1. 4-dia. vinyl-insulated round cable with 3 conductors (conductor cross section: 0.3 mm²; insulator diameter: 1.3 mm); standard length: 2 m
2. Operation indicator (yellow)

E2A-M30LN30-WP-□□

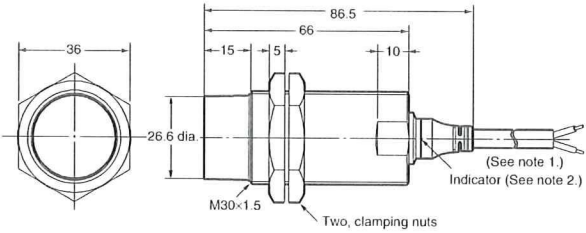

Note 1. 4-dia. vinyl-insulated round cable with 3 conductors (conductor cross section: 0.3 mm²; insulator diameter: 1.3 mm); standard length: 2 m
2. Operation indicator (yellow)

Mounting Hole Cutout Dimensions



| External diameter of Proximity Sensor | Dimension F (mm) |
|---------------------------------------|--|
| M8 | 8.5 dia. ^{+0.5} / ₀ |
| M12 | 12.5 dia. ^{+0.5} / ₀ |
| M18 | 18.5 dia. ^{+0.5} / ₀ |
| M30 | 30.5 dia. ^{+0.5} / ₀ |

M12 Connector Models (Shielded)



E2A-S08KS02-M1-□□
E2A-M08KS02-M1-□□

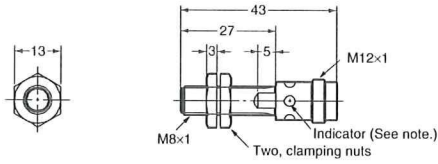

Note: Operation indicator (yellow LED, 4×90°)

M12 Connector Models (Non-shielded)



E2A-S08KN04-M1-□□
E2A-M08KN04-M1-□□

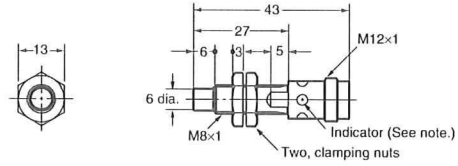

Note: Operation indicator (yellow LED, 4×90°)

E2A-M12KS04-M1-□□

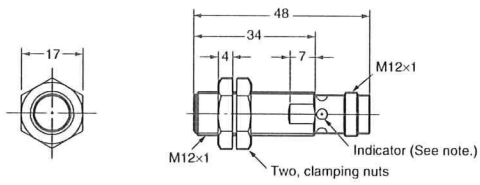

Note: Operation indicator (yellow LED, 4×90°)

E2A-M12KN08-M1-□□

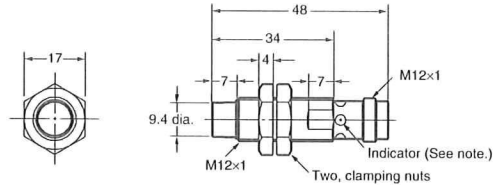

Note: Operation indicator (yellow LED, 4×90°)

E2A-M18KS08-M1-□□

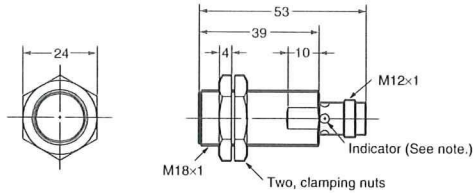

Note: Operation indicator (yellow LED, 4×90°)

E2A-M18KN16-M1-□□

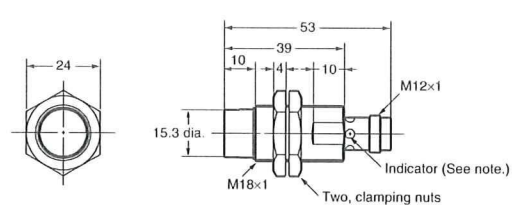

Note: Operation indicator (yellow LED, 4×90°)

E2A-M30KS15-M1-□□

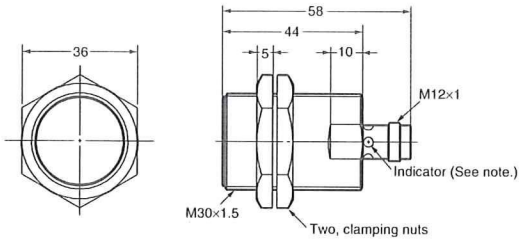

Note: Operation indicator (yellow LED, 4×90°)

E2A-M30KN20-M1-□□

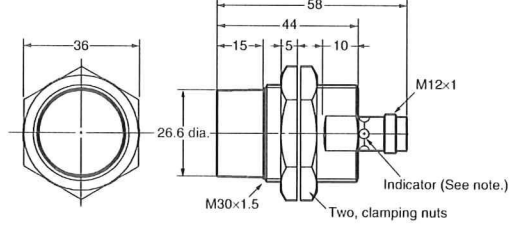

Note: Operation indicator (yellow LED, 4×90°)

E2A-S08LS02-M1-□□
E2A-M08LS02-M1-□□

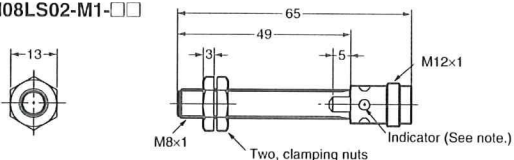

Note: Operation indicator (yellow LED, 4×90°)

E2A-S08LN04-M1-□□
E2A-M08LN04-M1-□□

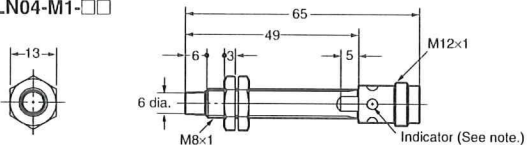

Note: Operation indicator (yellow LED, 4×90°)

E2A-M12LS04-M1-□□

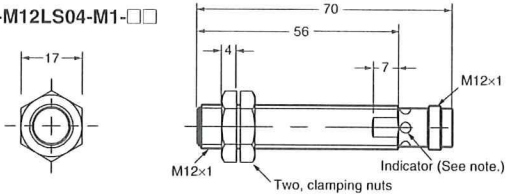

Note: Operation indicator (yellow LED, 4×90°)

E2A-M12LN08-M1-□□

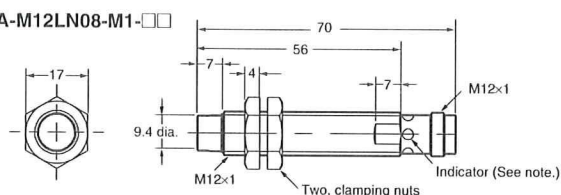

Note: Operation indicator (yellow LED, 4×90°)

E2A-M18LS08-M1-□□

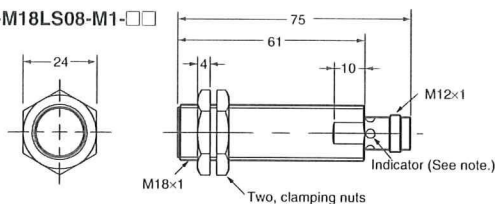

Note: Operation indicator (yellow LED, 4×90°)

E2A-M18LN16-M1-□□

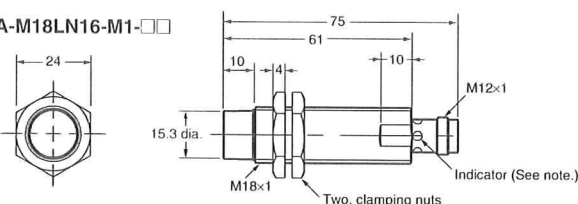

Note: Operation indicator (yellow LED, 4×90°)

E2A-M30LS15-M1-□□

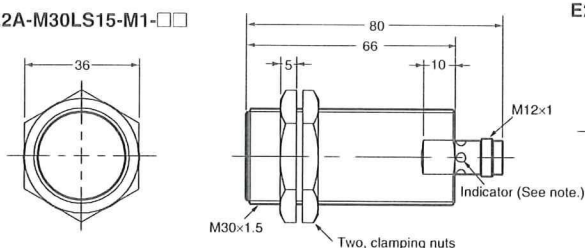

Note: Operation indicator (yellow LED, 4×90°)

E2A-M30LN30-M1-□□

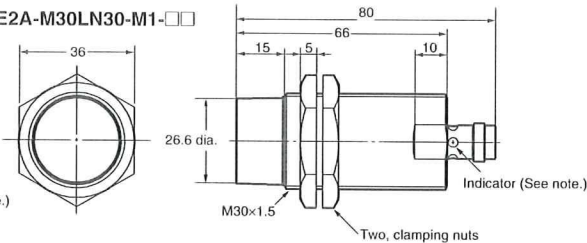

Note: Operation indicator (yellow LED, 4×90°)

M8 Connector Models (Shielded)



E2A-S08KS02-M5-□□

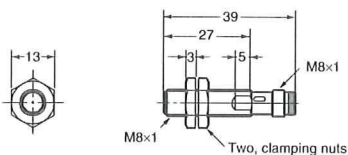

Note: Operation indicator (yellow LED, 4×90°)

M8 Connector Models (Non-shielded)



E2A-S08KN04-M5-□□

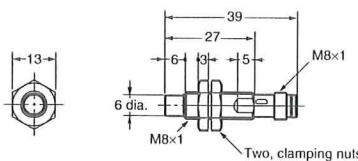

Note: Operation indicator (yellow LED, 4×90°)

E2A-S08LS02-M5-□□

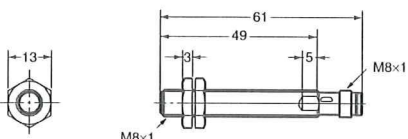

Note: Operation indicator (yellow LED, 4×90°)

E2A-S08LN04-M5-□□

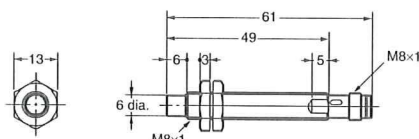

Note: Operation indicator (yellow LED, 4×90°)

Precautions

■ Safety Precautions

Power Supply

Do not impose an excessive voltage on the E2A, otherwise it may be damaged. Do not impose AC current (100 to 240 VAC) on any DC model, otherwise it may be damaged.

Load Short-circuit

Do not short-circuit the load, or the E2A may be damaged. The E2A's short-circuit protection function will be valid if the polarity of the supply voltage imposed is correct and within the rated voltage range.

Wiring

Be sure to wire the E2A and load correctly, otherwise it may be damaged.

Connection with No Load

Be sure to insert loads when wiring. Make sure to connect a proper load to the E2A in operation, otherwise it may damage internal elements.

Do not expose the product to flammable or explosive gases.

Do not disassemble, repair, or modify the product.

■ Correct Use

Designing

Power Reset Time

The Proximity Sensor is ready to operate within 100 ms after power is supplied. If power supplies are connected to the Proximity Sensor and load respectively, be sure to supply power to the Proximity Sensor before supplying power to the load.

Effects of Surrounding Metal

When mounting the E2A within a metal panel, ensure that the clearances given in the following table are maintained.

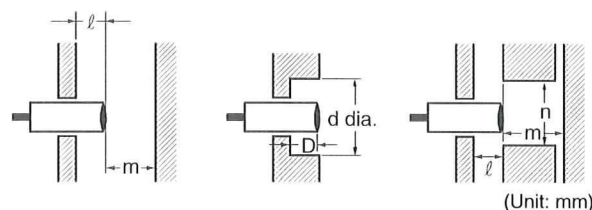

| Type | Dimension | M8 | M12 | M18 | M30 | |
|--------------|-----------|-----|-----|--------------------|--------------------|-------------|
| | | | | | Short barrel | Long barrel |
| Shielded | l | 0 | 0 | 0 (See note 1.) | 0 (See note 2.) | |
| | m | 4.5 | 12 | 24 | 45 | |
| | d | --- | --- | 27 | 45 | |
| | D | 0 | 0 | 1.5 | 4 | |
| | n | 12 | 18 | 27 | 45 | |
| Non-shielded | l | 12 | 15 | 22 | 30 | 40 |
| | m | 8 | 20 | 48 | 70 | 90 |
| | d | 24 | 40 | 70 | 90 | 120 |
| | D | 12 | 15 | 22 | 30 | 40 |
| | n | 24 | 40 | 70 | 90 | 120 |

- Note 1.** In the case of using the supplied nuts.
If true flush mounting is necessary, apply a free zone of 1.5 mm.
- 2.** In the case of using the supplied nuts.
If true flush mounting is necessary, apply a free zone of 4 mm.

Power OFF

The Proximity Sensor may output a pulse signal when it is turned OFF. Therefore, it is recommended that the load be turned OFF before turning OFF the Proximity Sensor.

Power Supply Transformer

When using a DC power supply, make sure that the DC power supply has an insulated transformer. Do not use a DC power supply with an auto-transformer.

Mutual Interference

When installing two or more Sensors face-to-face or side-by-side, ensure that the minimum distances given in the following table are maintained.

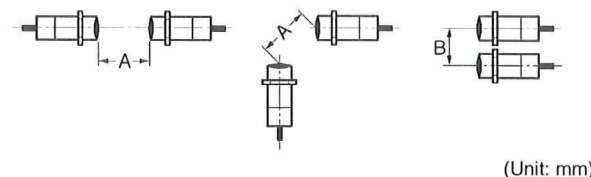

| Type | Dimension | M8 | M12 | M18 | M30 | |
|--------------|-----------|----|-----|-----|--------------|-------------|
| | | | | | Short barrel | Long barrel |
| Shielded | A | 20 | 30 | 60 | 110 | |
| | B | 15 | 20 | 35 | 70 | |
| Non-shielded | A | 80 | 120 | 200 | 300 | 300 |
| | B | 60 | 100 | 120 | 200 | 300 |

Wiring

High-tension Lines

Wiring through Metal Conduit:

If there is a power or high-tension line near the cable of the Proximity Sensor, wire the cable through an independent metal conduit to prevent against Proximity Sensor damage or malfunctioning.

Cable Extension

Standard cable length is less than 200 m.

The tractive force is 50 N.

Mounting

The Proximity Sensor must not be subjected to excessive shock with a hammer when it is installed, otherwise the Proximity Sensor may be damaged or lose its water-resistivity.

Do not tighten the nut with excessive force. A washer must be used with the nut.



| Type | | Torque |
|------|----------------------|---------|
| M8 | Stainless steel type | 9 N·m |
| | Brass type | 4 N·m |
| M12 | | 30 N·m |
| M18 | | 70 N·m |
| M30 | | 180 N·m |

Maintenance and Inspection

Periodically perform the following checks to ensure stable operation of the Proximity Sensor over a long period of time.

1. Check for mounting position, dislocation, looseness, or distortion of the Proximity Sensor and sensing objects.
2. Check for loose wiring and connections, improper contacts, and line breakage.
3. Check for attachment or accumulation of metal powder or dust.
4. Check for abnormal temperature conditions and other environmental conditions.
5. Check for proper lighting of indicators (for models with a set indicator.)

Never disassemble or repair the Sensor.

Environment

Water Resistivity

Do not use the Proximity Sensor underwater, outdoors, or in the rain.

Operating Environment

Be sure to use the Proximity Sensor within its operating ambient temperature range and do not use the Proximity Sensor outdoors so that its reliability and life expectancy can be maintained. Although the Proximity Sensor is water resistive, a cover to protect the Proximity Sensor from water or water-soluble machining oil is recommended so that its reliability and life expectancy can be maintained.

Do not use the Proximity Sensor in an environment with chemical gas (e.g., strong alkaline or acid gasses including nitric, chromic, and concentrated sulfuric acid gasses).

Inrush Current

A load that has a large inrush current (e.g., a lamp or motor) will damage the Proximity Sensor, in which case connect the load to the Proximity Sensor through a relay.

Warranties, Limitations of Liability

■ WARRANTY

OMRON's exclusive warranty is that the products are free from defects in materials and workmanship for a period of one year (or other period if specified) from date of sale by OMRON.

OMRON MAKES NO WARRANTY OR REPRESENTATION, EXPRESS OR IMPLIED, REGARDING NON-INFRINGEMENT, MERCHANTABILITY, OR FITNESS FOR PARTICULAR PURPOSE OF THE PRODUCTS. ANY BUYER OR USER ACKNOWLEDGES THAT THE BUYER OR USER ALONE HAS DETERMINED THAT THE PRODUCTS WILL SUITABLY MEET THE REQUIREMENTS OF THEIR INTENDED USE. OMRON DISCLAIMS ALL OTHER WARRANTIES, EXPRESS OR IMPLIED.

■ LIMITATIONS OF LIABILITY

OMRON SHALL NOT BE RESPONSIBLE FOR SPECIAL, INDIRECT, OR CONSEQUENTIAL DAMAGES, LOSS OF PROFITS OR COMMERCIAL LOSS IN ANY WAY CONNECTED WITH THE PRODUCTS, WHETHER SUCH CLAIM IS BASED ON CONTRACT, WARRANTY, NEGLIGENCE, OR STRICT LIABILITY.

In no event shall responsibility of OMRON for any act exceed the individual price of the product on which liability is asserted.

IN NO EVENT SHALL OMRON BE RESPONSIBLE FOR WARRANTY, REPAIR, OR OTHER CLAIMS REGARDING THE PRODUCTS UNLESS OMRON'S ANALYSIS CONFIRMS THAT THE PRODUCTS WERE PROPERLY HANDLED, STORED, INSTALLED, AND MAINTAINED AND NOT SUBJECT TO CONTAMINATION, ABUSE, MISUSE, OR INAPPROPRIATE MODIFICATION OR REPAIR.

Application Considerations

■ SUITABILITY FOR USE

OMRON shall not be responsible for conformity with any standards, codes, or regulations that apply to the combination of products in the customer's application or use of the products.

Take all necessary steps to determine the suitability of the product for the systems, machines, and equipment with which it will be used.

Know and observe all prohibitions of use applicable to this product.

NEVER USE THE PRODUCTS FOR AN APPLICATION INVOLVING SERIOUS RISK TO LIFE OR PROPERTY WITHOUT ENSURING THAT THE SYSTEM AS A WHOLE HAS BEEN DESIGNED TO ADDRESS THE RISKS, AND THAT THE OMRON PRODUCT IS PROPERLY RATED AND INSTALLED FOR THE INTENDED USE WITHIN THE OVERALL EQUIPMENT OR SYSTEM.

Disclaimers

■ CHANGE IN SPECIFICATIONS

Product specifications and accessories may be changed at any time based on improvements and other reasons. Consult with your OMRON representative at any time to confirm actual specifications of purchased product.

■ DIMENSIONS AND WEIGHTS

Dimensions and weights are nominal and are not to be used for manufacturing purposes, even when tolerances are shown.

ALL DIMENSIONS SHOWN ARE IN MILLIMETERS.

To convert millimeters into inches, multiply by 0.03937. To convert grams into ounces, multiply by 0.03527.

Cat. No. D100-E1-01B

In the interest of product improvement, specifications are subject to change without notice.

OMRON Corporation

Industrial Automation Company

Sensing Devices Division H.Q.

Industrial Sensors Division

Shiokoji Horikawa, Shimogyo-ku,

Kyoto, 600-8530 Japan

Tel: (81)75-344-7022/Fax: (81)75-344-7107

