

# Miniature Power Relays MY(S)

## Our Best Selling General-purpose Relays



- Now lead-free to protect the environment.
- VDE certification (Germany).
- Different colors of coil tape for AC and DC models to more easily distinguish them.
- Easy circuit checking on models with latching levers.



Refer to the Common Relay Precautions and Safety Precautions on page 34.

The compliant standards depend on the model.  
For details, refer to information provided for individual models.

## Model Number Structure

Classification	Structure	Relays with Plug-in Terminals			PCB terminals	Case-surface mounting
		With operation indicator	Without operation indicator	With latching lever		
Standard models (compliant with Electrical Appliances and Material Safety Act)	2 Bifurcated	MY2N(S)	/	MY2IN(S)	MY2-02	MY2F
		MY2ZN		MY4IN(S)	MY3-02	MY3F
	3	MY3N		MY4ZIN(S)	MY4-02	MY4F
		MY4N(S)		MY4ZN(S)	MY4Z-02	MY4ZF
Reverse coil polarity	2	MY2N1(S)	/	MY2IN1(S)	/	/
		MY2N1-D2(S)		MY2IN1-D2(S)		
	4	MY4N1(S)		MY4IN1(S)		
		MY4N1-D2(S)		MY4IN1-D2(S)		
	Bifurcated	MY4ZN1(S)		MY4ZIN1(S)		
		MY4ZN1-D2(S)		MY4ZIN1-D2(S)		
Models with diode for coil surge absorption (DC coil specification only) 	2 Bifurcated	MY2N-D2(S)	/	MY2IN-D2(S)	/	/
		MY2ZN-D2		MY4IN-D2(S)		
	3	MY3N-D2		MY4ZIN-D2(S)		
	4 Bifurcated	MY4N-D2(S)		MY4ZIN-D2(S)		
MY4ZN-D2(S)		MY4ZIN-D2(S)				
Models with CR circuit for coil surge absorption (AC coil specification only) 	2	MY2N-CR(S)	/	MY2IN-CR(S)	/	/
	4 Bifurcated	MY4N-CR(S)		MY4IN-CR(S)		
		MY4ZN-CR(S)		MY4ZIN-CR(S)		
Models with high contact reliability	4 Bifurcated	---	MY4Z-CBG	---	---	---
Plastic sealed models	4 Bifurcated	MYQ4N	/	MYQ4Z	MYQ4-02	---
		---		MYQ4Z-02	---	
Latching models (coil latching)	2	---	MY2K	---	MY2K-02	---
Hermetic models	4 Bifurcated	---	/	MY4H	/	MY4H-0
		---		MY4ZH		MY4ZH-0

**Note:** 1. The models in this table are UL/CSA certified. This is indicated with a certification mark on the products. (This does not include models with high contact reliability or plastic sealed, latching, or hermetically sealed models.)  
 2. The standard models with plug-in terminals, models with coil surge absorption diodes, and models with coil surge absorption CR circuits were used in combination with the PYF-E and PYFS (2-pole and 4-pole) for the EC Declaration of Conformity. These products display the CE Marking.  
 3. Products cannot be manufactured for the cells with a diagonal line. Ask your OMRON representative for details on manufacturing products for cells containing "----" in the above table.

Refer to *Connection Socket and Mounting Bracket Selection Table* on page 27 in *Options* for information on the possible combinations of Models with Plug-in Terminals and Sockets.

# MY(S)

## Specifications

### Coil Ratings

Rated voltage		Rated current		Coil resistance	Coil inductance (reference value)		Must operate voltage	Must release voltage	Max. voltage	Power consumption (approx.)
		50 Hz	60 Hz		Arm. OFF	Arm. ON				
AC	6 V	214.1 mA	183 mA	12.2 Ω	0.04 H	0.08 H	80% max.	30% min.	110%	1.0 to 1.2 VA (60 Hz)
	12 V	106.5 mA	91 mA	46 Ω	0.17 H	0.33 H				
	24 V	53.8 mA	46 mA	180 Ω	0.69 H	1.30 H				
	48/50 V	24.7/ 25.7 mA	21.1/ 22.0 mA	788 Ω	3.22 H	5.66 H				
	110/120 V	9.9/10.8 mA	8.4/9.2 mA	4,430 Ω	19.20 H	32.1 H				
	220/240 V	4.8/5.3 mA	4.2/4.6 mA	18,790 Ω	83.50 H	136.4 H				
DC	6 V	151 mA		39.8 Ω	0.17 H	0.33 H	10% min.			0.9 W
	12 V	75 mA		160 Ω	0.73 H	1.37 H				
	24 V	37.7 mA		636 Ω	3.20 H	5.72 H				
	48 V	18.8 mA		2,560 Ω	10.60 H	21.0 H				
	100/110 V	9.0/9.9 mA		11,100 Ω	45.60 H	86.2 H				

**Note:** 1. The rated current and coil resistance are measured at a coil temperature of 23°C with tolerances of +15%/–20% for rated currents and ±15% for DC coil resistance.

2. Performance characteristic data are measured at a coil temperature of 23°C.

3. AC coil resistance and impedance are provided as reference values (at 60 Hz).

4. Power consumption drop was measured for the above data. When driving transistors, check leakage current and connect a bleeder resistor if required.

# Miniature Power Relays: MY2(S)/MY4(S)/MY4Z(S)



Refer to the standards certifications and compliance section of your OMRON website for the latest information on certified models.

## Ratings and Specifications

### Ratings

#### Contact Ratings

Item	2-pole		4-pole		4-pole (bifurcated)	
	Resistive load (cos φ = 1)	Inductive load (cos φ = 0.4, L/R = 7 ms)	Resistive load (cos φ = 1)	Inductive load (cos φ = 0.4, L/R = 7 ms)	Resistive load (cos φ = 1)	Inductive load (cos φ = 0.4, L/R = 7 ms)
Rated load	5A, 250 VAC 5A, 30 VDC	2A, 250 VAC 2 A, 30 VDC	3 A, 250 VAC 3 A, 30 VDC	0.8 A, 250 VAC 1.5 A, 30 VDC	3 A, 250 VAC 3 A, 30 VDC	0.8 A, 250 VAC 1.5 A, 30 VDC
Carry current	10 A (see note)		5 A (see note)			
Max. switching voltage	250 VAC 125 VDC					
Max. switching current	10 A		5 A			
Contact materials	Ag		Au cladding + Ag alloy			
Failure rate (reference value)	5 VDC, 1 mA		1 VDC, 1 mA		1 VDC, 100 μA	

Note: Don't exceed the carry current of a Socket in use. Please see page 26.

### Characteristics

Item	All Relays
Contact resistance	100 mΩ max. (50 mΩ: 4-pole bifurcated)
Operate time	20 ms max.
Release time	20 ms max.
Max. operating frequency	Mechanical:18,000 operations/hr Electrical:1,800 operations/hr (under rated load)
Insulation resistance	100 MΩ min. (at 500 VDC)
Dielectric strength	2,000 VAC, 50/60 Hz for 1.0 min (1,000 VAC between contacts of same polarity)
Vibration resistance	Destruction:10 to 55 to 10 Hz, 0.5 mm single amplitude (1.0 mm double amplitude) Malfunction:10 to 55 to 10 Hz, 0.5 mm single amplitude (1.0 mm double amplitude)
Shock resistance	Destruction:1,000 m/s <sup>2</sup> Malfunction:200 m/s <sup>2</sup>
Endurance	See the following table.
Ambient temperature	Operating: -55°C to 70°C (with no icing)
Ambient humidity	Operating: 5% to 85%
Weight	Approx. 35 g

Note: The values given above are initial values.

### Endurance Characteristics

Pole	Mechanical life (at 18,000 operations/hr)	Electrical life (at 1,800 operations/hr under rated load)
2-pole	AC:50,000,000 operations min. DC:100,000,000 operations min.	500,000 operations min.
4-pole		200,000 operations min.
4-pole (bifurcated)	20,000,000 operations min.	100,000 operations min.

# MY(S)

## Dimensions

(Unit: mm)

### List of Models

MY2IN(S)

MY2IN-D2(S)

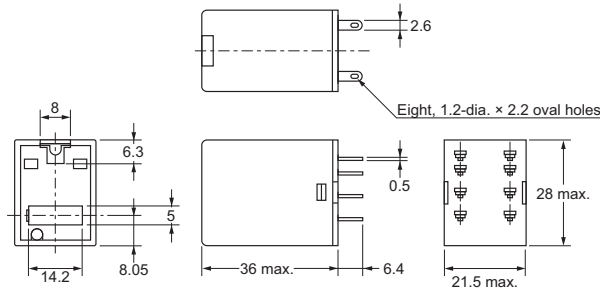
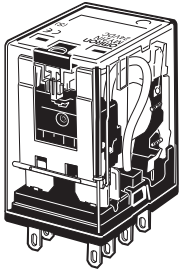

Terminal Arrangement/Internal Connections (Bottom View)

MY2IN(S)  
(AC Model)

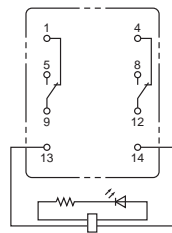

MY2IN(S)  
(DC Models)

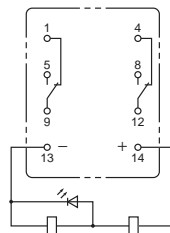

MY2IN-D2(S)  
(DC Models Only)

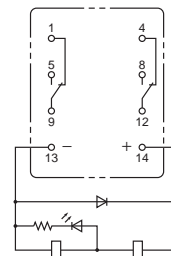

**Note:** For the DC models, check the coil polarity when wiring and wire all connections correctly.

MY4(Z) IN(S)

MY4(Z) IN-D2(S)

MY4(Z) IN-CR(S)

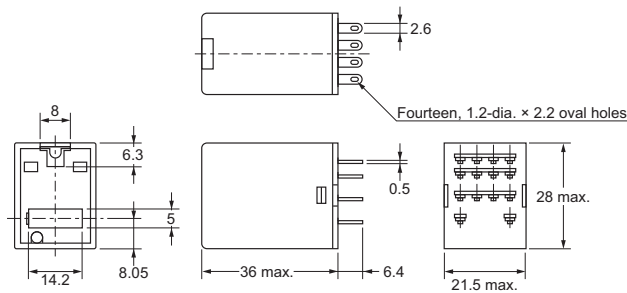
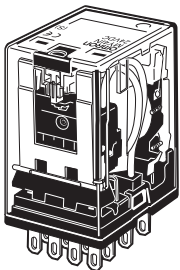

Terminal Arrangement/Internal Connections (Bottom View)

MY4(Z)IN(S)  
(DC Models)

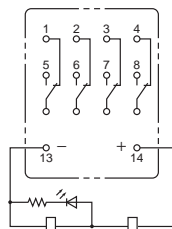

MY4(Z)IN(S)  
(AC Models)

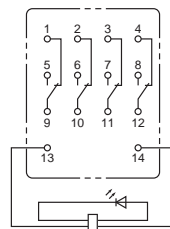

MY4(Z)IN-D2(S)  
(DC Models Only)

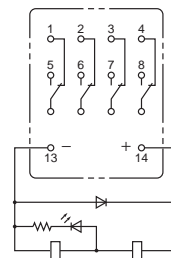

MY4(Z)IN-CR(S)  
(AC Models Only)

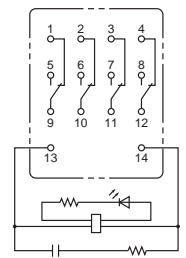

**Note:** For the DC models, check the coil polarity when wiring and wire all connections correctly.

# Engineering Data MY2(S)/ MY4(S)/MY4Z(S)

## Engineering Data

### Maximum Switching Capacity MY2(S)

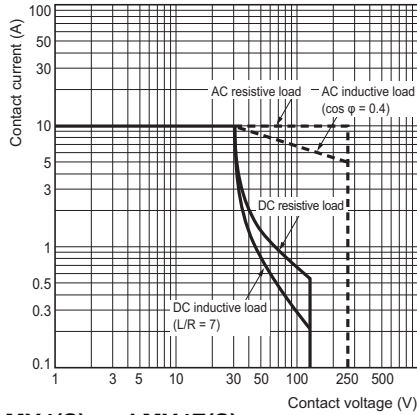

### MY4(S) and MY4Z(S)

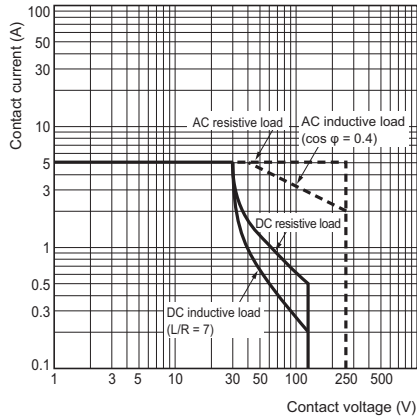

### Endurance Curve MY2(S)

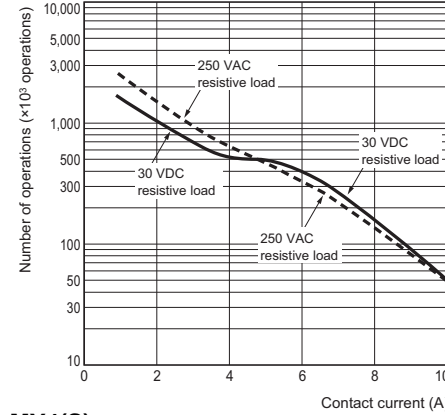

### MY2(S)

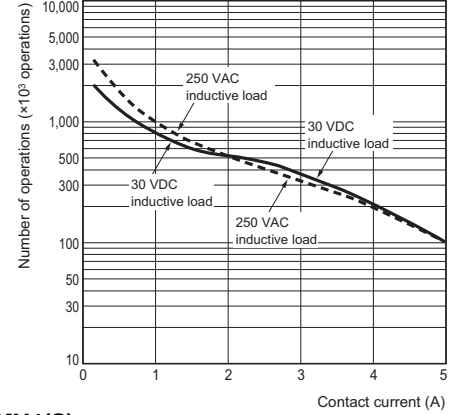

### MY4(S)

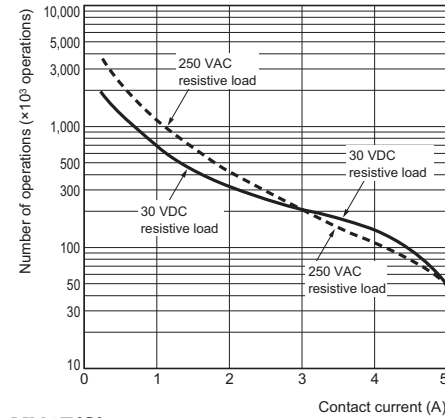

### MY4(S)

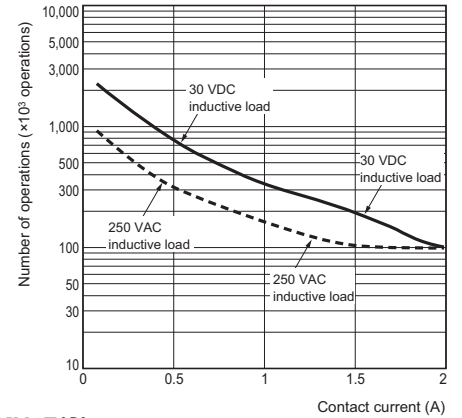

### MY4Z(S)

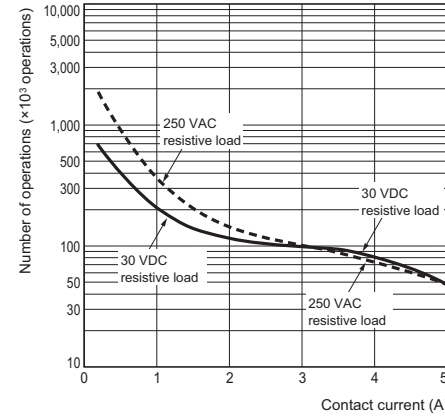

### MY4Z(S)

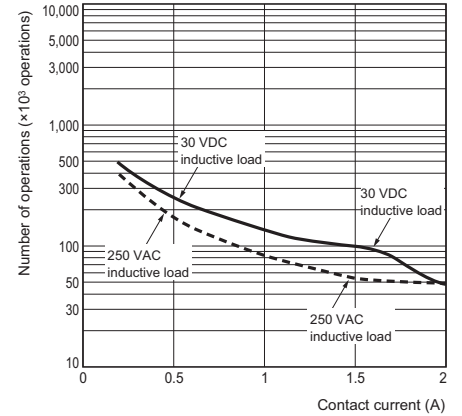

## Common Specifications for MY2(S)/MY4(S)/MY4Z(S)

### Malfunctioning Shock

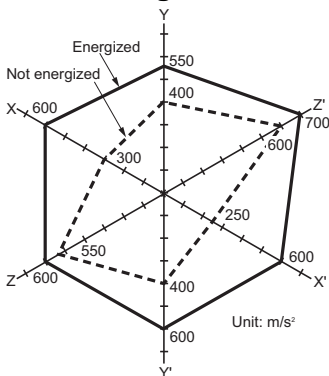

N = 20

Measurement: Shock was applied 3 times each in 6 directions along 3 axes with the Relay energized and not energized to check the shock values that cause the Relay to malfunction.

Criteria: Non-energized: 200 m/s<sup>2</sup>,  
Energized: 200 m/s<sup>2</sup>

#### Shock direction

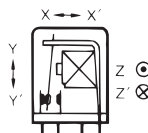

# MY(S)

## Detailed Information on Models Certified for Safety Standards, MY2(S)/MY4(S)/MY4Z(S)

### VDE-certified Models (No. 112467UG, EN61810-1)

Model	Number of poles	Coil ratings	Contact ratings	File No.	Certified number of operations
MY□	2	6, 12, 24, 48/50, 100/ 110, 110/120, 200/ 220, and 220/240 VAC	10 A, 250 VAC (cos φ = 1) 10 A, 30 VDC (L/R = 0 ms)	6692 (VDE0435)	MY2: 10,000 operations MY4: 100,000 operations MY4Z: 50,000 operations (AC)
	4		5 A, 250 VAC (cos φ = 1) 5 A, 30 VDC (L/R = 0 ms)		

### UL508-certified Models (File No. 41515)

Model	Number of poles	Coil ratings	Contact ratings	File No.	Certified number of operations
MY□	2	6 to 240 VAC 6 to 125 VDC	10A, 250 VAC (General Use)	E41515 (UL508)	6,000
			10A, 30 VDC (General Use)		
			7A, 240 VAC (General Use)		
			7A, 24 VDC (Resistive)		
			5A, 240 VAC (General Use)		
			5A, 250 VAC (Resistive)		
			5A, 30 VDC (Resistive)		
			3A, 265 VAC (Resistive)		
			1/6HP, 250 VAC		
			1/8HP, 265 VAC		
	1/10HP, 120 VAC		1,000		
	B300 Pilot Duty (Same polarity)		6,000		
	4		5A, 28 VDC (General Use) (Same polarity)		6,000
			5A, 240 VAC (General Use) (Same polarity)		
			5A, 30 VDC (Resistive) (Same polarity)		
			5A, 250 VAC (Resistive) (Same polarity)		
			0.2A, 120 VDC (Resistive) (Same polarity)		
			1/6HP, 250 VAC (Same polarity)		
			1/10HP, 120 VAC (Same polarity)		
			B300 Pilot Duty (Same polarity)		
		6,000			
		6,000			

### CSA 22.2 No. 14-certified Models (File No. LR31928)

Model	Number of poles	Coil ratings	Contact ratings	File No.	Certified number of operations	
MY□	2	6 to 240 VAC 6 to 125 VDC	7A, 240 VAC (General Use)	LR31928 (CSA C22.2) (No. 14)	6,000	
			7A, 24 VDC (Resistive)			
			5A, 240 VAC (General Use)			
			5A, 250 VAC (Resistive)			
			5A, 30 VDC (Resistive)			
			3A, 265 VAC (Resistive)			
			1/6HP, 250 VAC			
			1/8HP, 265 VAC			
			1/10HP, 120 VAC			1,000
			B300 Pilot Duty (Same polarity)			6,000
	4		5A, 240 VAC (General Use) (Same polarity)		6,000	
			5A, 28 VDC (General Use) (Same polarity)			
			5A, 250 VAC (Resistive) (Same polarity)			
			5A, 30 VDC (Resistive) (Same polarity)			
			0.2A, 120 VDC (Resistive) (Same polarity)			
			1/6HP, 250 VAC (Same polarity)			
			1/10HP, 120 VAC (Same polarity)			
			B300 Pilot Duty (Same polarity)			1,000
						6,000
						6,000

### LR-certified Models (File No. 98/10014)

Model	Number of poles	Coil ratings	Contact ratings	File No.	Certified number of operations
MY□	2	6 to 240 VAC 6 to 125 VDC	10 A, 250 VAC (resistive) 2 A, 250 VAC (PF0.4) 10 A, 30 VDC (resistive) 2 A, 30 VDC (L/R = 7 ms)	98/10014	MY2: 50,000 operations MY4: 50,000 operations
	4		5 A, 250 VAC (resistive) 0.8 A, 250 VAC (PF0.4) 5 A, 30 VDC (resistive) 1.5 A, 30 VDC (L/R = 7 ms)		

# Miniature Power Relays: MY2Z



Refer to the standards certifications and compliance section of your OMRON website for the latest information on certified models.

## Ratings and Specifications

### Ratings

#### Contact Ratings

Item	Load	Resistive load	Inductive load ( $\cos \phi = 0.4, L/R = 7 \text{ ms}$ )
Rated load		5 A at 220 VAC 5 A at 24 VDC	2 A at 220 VAC 2 A at 24 VDC
Rated carry current		5 A	
Maximum contact voltage		250 VAC, 125 VDC	
Maximum contact current		5 A	
Contact configuration		DPDT	
Contact structure		Bifurcated	
Contact materials		Au plating + Ag	

Item	Type	Standard models	Model with built-in operation indicator, diode, or CR circuit
Ambient operating temperature <sup>*1</sup>		-55 to 70° C	-55 to 60° C <sup>*2</sup>
Ambient operating humidity		5% to 85%	

\*1. With no icing or condensation.

\*2. This limitation is due to the diode junction temperature and elements used.

### Characteristics

Item	Type	Standard models	Models with built-in operation indicators	Models with built-in diodes	Model with built-in operation indicator and diode	Models with built-in CR circuits	Models with built-in CR circuits and operation indicators
Contact resistance <sup>*1</sup>		50 mΩ max.					
Operation time <sup>*2</sup>		20 ms max.					
Release time <sup>*2</sup>		20 ms max.					
Maximum operating frequency	Mechanical	18,000 operations/h					
	Rated load	1,800 operations/h					
Insulation resistance <sup>*3</sup>		100 MΩ min.					
Dielectric strength	Between coil and contacts	2,000 VAC at 50/60 Hz for 1 min.					
	Between contacts of different polarity						
	Between contacts of the same polarity						
Vibration resistance	Destruction	10 to 55 to 10 Hz, 0.5-mm single amplitude (1.0-mm double amplitude)					
	Malfunction	10 to 55 to 10 Hz, 0.5-mm single amplitude (1.0-mm double amplitude)					
Shock resistance	Destruction	1,000 m/s <sup>2</sup>					
	Malfunction	200 m/s <sup>2</sup>					
Endurance	Mechanical	50,000,000 operations min. (operating frequency: 18,000 operations/h)					
	Electrical <sup>*4</sup>	200,000 operations min. (rated load, switching frequency: 1,800 operations/h)					

Item	Number of poles	2 poles
Failure rate P value (reference value) <sup>*5</sup>		100 μA at 1 VDC
Weight		Approx. 35 g

Note: These are initial values.

\*1. Measurement conditions: 1 A at 5 VDC using the voltage drop method.

\*2. Measurement conditions: With rated operating power applied.

Ambient temperature condition: 23° C

\*3. Measurement conditions: For 500 VDC applied to the same location as for dielectric strength measurement.

\*4. Ambient temperature condition: 23° C

\*5. This value was measured at a switching frequency of 120 operations per minute.

# MY(S)

## Dimensions

(Unit: mm)

MY2Z, MY2ZN, MY2Z-D, MY2ZN-D2, MY2Z-CR, and MY2ZN-CR

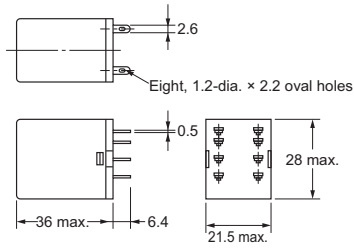
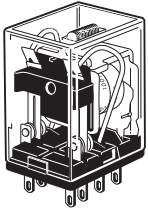

\* For the MY2Z-CR and MY2ZN-CR, this dimension is 53 mm max.

### Terminal Arrangement/ Internal Connections (Bottom View) Standard Models

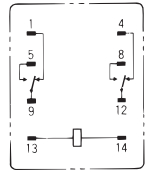

(The coil has no polarity.)

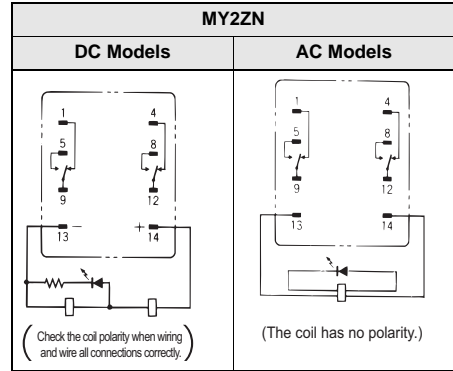

- Note:**
1. An AC model has coil disconnection self-diagnosis.
  2. For the DC models, check the coil polarity when wiring and wire all connections correctly.
  3. The indicator is red for AC and green for DC.
  4. The operation indicator indicates the energization of the coil and does not represent contact operation.

### MY2Z-D

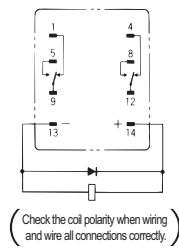

### MY2ZN-D2

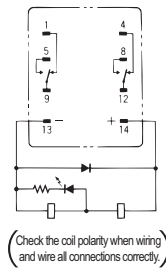

### MY2Z-CR

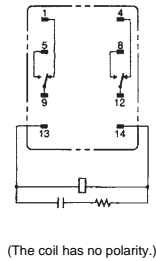

### MY2ZN-CR

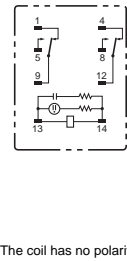



# Miniature Power Relays: MY3



Refer to the standards certifications and compliance section of your OMRON website for the latest information on certified models.

## Ratings and Specifications

### Ratings

#### Contact Ratings

Item	Load	Resistive load	Inductive load ( $\cos \phi = 0.4, L/R = 7 \text{ ms}$ )
Rated load		5 A at 220 VAC 5 A at 24 VDC	2 A at 220 VAC 2 A at 24 VDC
Rated carry current		5 A	
Maximum contact voltage		250 VAC, 125 VDC	
Maximum contact current		5 A	
Contact configuration		3PDT	
Contact structure		Single	
Contact materials		Ag	

Item	Type	Standard models	Operation indicator and diode
Ambient operating temperature <sup>*1</sup>		-55 to 70° C	-55 to 60° C <sup>*2</sup>
Ambient operating humidity		5% to 85%	

\*1. With no icing or condensation.

\*2. This limitation is due to the diode junction temperature and elements used.

### Characteristics

Item	Type	Standard models	Models with built-in operation indicators	Models with built-in diodes	Model with built-in operation indicator and diode
Contact resistance <sup>*1</sup>		50 mΩ max.			
Operation time <sup>*2</sup>		20 ms max.			
Release time <sup>*2</sup>		20 ms max.			
Maximum operating frequency	Mechanical	18,000 operations/h			
	Rated load	1,800 operations/h			
Insulation resistance <sup>*3</sup>		100 MΩ min.			
Dielectric strength	Between coil and contacts				
	Between contacts of different polarity	2,000 VAC at 50/60 Hz for 1 min.			
	Between contacts of the same polarity	1,000 VAC at 50/60 Hz for 1 min.			
Vibration resistance	Destruction	10 to 55 to 10 Hz, 0.5-mm single amplitude (1.0-mm double amplitude)			
	Malfunction	10 to 55 to 10 Hz, 0.5-mm single amplitude (1.0-mm double amplitude)			
Shock resistance	Destruction	1,000 m/s <sup>2</sup>			
	Malfunction	200 m/s <sup>2</sup>			
Endurance	Mechanical	AC: 50,000,000 operations min. DC: 100,000,000 operations min. (switching frequency: 18,000 operations/h)			
	Electrical <sup>*4</sup>	500,000 operations min. (rated load, switching frequency: 1,800 operations/h)			

Item	Number of poles	3 poles
Failure rate P value (reference value) <sup>*5</sup>		1 mA at 5 VDC
Weight		Approx. 35 g

Note: These are initial values.

\*1. Measurement conditions: 1 A at 5 VDC using the voltage drop method

\*2. Measurement conditions: With rated operating power applied.  
Ambient temperature condition: 23° C

\*3. Measurement conditions: For 500 VDC applied to the same location as for dielectric strength measurement.

\*4. Ambient temperature condition: 23° C

\*5. This value was measured at a switching frequency of 120 operations per minute.

# MY(S)

## Dimensions

(Unit: mm)

### MY3, MY3N, MY3-D, and MY3N-D2

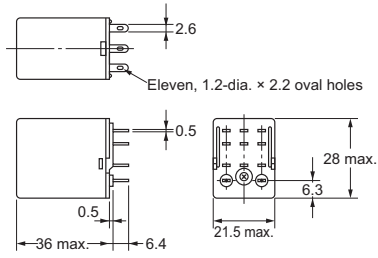
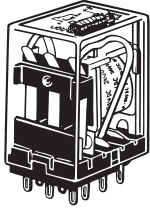

### Terminal Arrangement/ Internal Connections (Bottom View) Standard Models

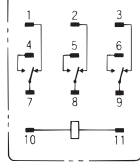

(The coil has no polarity.)

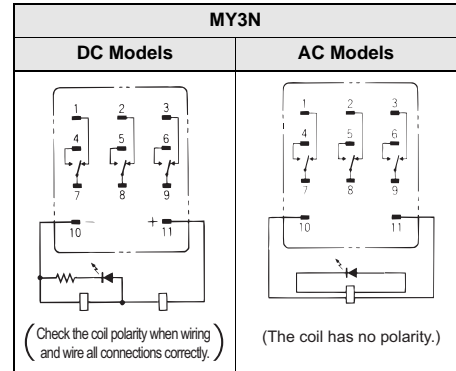

- Note:**
1. An AC model has coil disconnection self-diagnosis.
  2. For the DC models, check the coil polarity when wiring and wire all connections correctly.
  3. The indicator is red for AC and green for DC.
  4. The operation indicator indicates the energization of the coil and does not represent contact operation.

### MY3-D

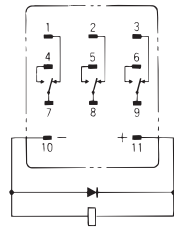

(Check the coil polarity when wiring and wire all connections correctly.)

### MY3N-D2

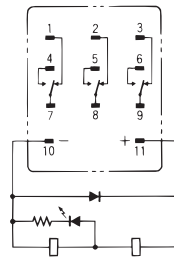

(Check the coil polarity when wiring and wire all connections correctly.)

## Relays with PCB Terminals: MY□-02



Refer to the standards certifications and compliance section of your OMRON website for the latest information on certified models.

## Ratings and Specifications

## Ratings

## Contact Ratings

Item	Number of poles Load	2 or 3 poles		4 poles		4 poles, bifurcated contacts	
		Resistive load	Inductive load ( $\cos \phi = 0.4$ , $L/R = 7$ ms)	Resistive load	Inductive load ( $\cos \phi = 0.4$ , $L/R = 7$ ms)	Resistive load	Inductive load ( $\cos \phi = 0.4$ , $L/R = 7$ ms)
Rated load	5 A at 220 VAC 5 A at 24 VDC	2 A at 220 VAC 2 A at 24 VDC	3 A at 220 VAC 3 A at 24 VDC	0.8 A at 220 VAC 1.5 A at 24 VDC	3 A at 220 VAC 3 A at 24 VDC	0.8 A at 220 VAC 1.5 A at 24 VDC	
Rated carry current	5 A		3 A				
Maximum contact voltage	250 VAC, 125 VDC		250 VAC, 125 VDC				
Maximum contact current	5 A		3 A				
Contact configuration	DPDT, 3PDT		4PDT				
Contact structure	Single		Single		Bifurcated		
Contact materials	Ag		Au plating + Ag				

Item	Type	Standard models
Ambient operating temperature*		-55 to 70° C
Ambient operating humidity		5% to 85%

\* With no icing or condensation.

## Characteristics

Item	Number of poles	2 or 3 poles	4 poles	4 poles, bifurcated contacts
Contact resistance <sup>1</sup>		50 mΩ max.		
Operation time <sup>2</sup>		20 ms max.		
Release time <sup>2</sup>		20 ms max.		
Maximum operating frequency	Mechanical	18,000 operations/h		
	Rated load	1,800 operations/h		
Insulation resistance <sup>3</sup>		100 MΩ min.		
Dielectric strength	Between coil and contacts	2,000 VAC at 50/60 Hz for 1 min.		
	Between contacts of different polarity	2,000 VAC at 50/60 Hz for 1 min.		
	Between contacts of the same polarity	1,000 VAC at 50/60 Hz for 1 min.		
Vibration resistance	Destruction	10 to 55 to 10 Hz, 0.5-mm single amplitude (1.0-mm double amplitude)		
	Malfunction	10 to 55 to 10 Hz, 0.5-mm single amplitude (1.0-mm double amplitude)		
Shock resistance	Destruction	1,000 m/s <sup>2</sup>		
	Malfunction	200 m/s <sup>2</sup>		
Endurance	Mechanical	AC: 50,000,000 operations min. DC: 100,000,000 operations min. (switching frequency: 18,000 operations/h)		AC: 20,000,000 operations min. (switching frequency: 18,000 operations/h)
	Electrical <sup>4</sup>	500,000 operations min. (rated load, switching frequency: 1,800 operations/h)	200,000 operations min. (rated load, switching frequency: 1,800 operations/h)	100,000 operations min. (rated load, switching frequency: 1,800 operations/h)

Item	Number of poles	2 or 3 poles	4 poles	4 poles, bifurcated contacts
Failure rate P value (reference value) <sup>5</sup>		1 mA at 5 VDC	1 mA at 1 VDC	100 μA at 1 VDC
Weight		Approx. 35 g		

Note: These are initial values.

\*1. Measurement conditions: 1 A at 5 VDC using the voltage drop method

\*2. Measurement conditions: With rated operating power applied.  
Ambient temperature condition: 23° C

\*3. Measurement conditions: For 500 VDC applied to the same location as for dielectric strength measurement.

\*4. Ambient temperature condition: 23° C

\*5. This value was measured at a switching frequency of 120 operations per minute.

# MY(S)

## Dimensions

(Unit: mm)

### Relays with PCB Terminals

#### MY□-02



The figures and dimensions given here are for the MY4-02. The 2-pole and 3-pole models conform to these dimensions.

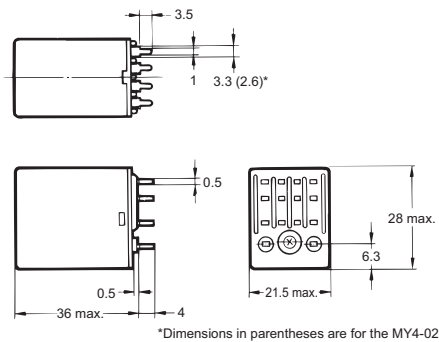

### PCB Processing Dimensions (Bottom View)

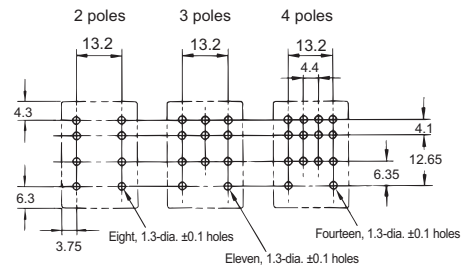

- Note:**
1. The dimensional tolerance is  $\pm 0.1$ .
  2. Refer to the terminal arrangement and internal connections diagrams for the MY2, MY3, MY4, and MY4Z.

# Case-surface-mounting Relays: MY□F



Refer to the standards certifications and compliance section of your OMRON website for the latest information on certified models.

## Ratings and Specifications

### Ratings

#### Contact Ratings

Item	Number of poles Load	2 or 3 poles		4 poles	
		Resistive load	Inductive load (cos φ = 0.4, L/R = 7 ms)	Resistive load	Inductive load (cos φ = 0.4, L/R = 7 ms)
Rated load	5 A at 220 VAC 5 A at 24 VDC	2 A at 220 VAC 2 A at 24 VDC	3 A at 220 VAC 3 A at 24 VDC	0.8 A at 220 VAC 1.5 A at 24 VDC	
Rated carry current	5 A		3 A		
Maximum contact voltage	250 VAC, 125 VDC				
Maximum contact current	5 A		3 A		
Contact configuration	DPDT, 3PDT		4PDT		
Contact structure	Single				
Contact materials	Ag		Au plating + Ag		

Item	Type	Standard models
Ambient operating temperature*		-55 to 70° C
Ambient operating humidity		5% to 85%

\* With no icing or condensation.

### Characteristics

Item	Number of poles	2 or 3 poles	4 poles
Contact resistance <sup>*1</sup>		50 mΩ max.	
Operation time <sup>*2</sup>		20 ms max.	
Release time <sup>*2</sup>		20 ms max.	
Maximum operating frequency	Mechanical	18,000 operations/h	
	Rated load	1,800 operations/h	
Insulation resistance <sup>*3</sup>		100 MΩ min.	
Dielectric strength	Between coil and contacts	2,000 VAC at 50/60 Hz for 1 min.	
	Between contacts of different polarity	2,000 VAC at 50/60 Hz for 1 min.	
	Between contacts of the same polarity	1,000 VAC at 50/60 Hz for 1 min.	
Vibration resistance	Destruction	10 to 55 to 10 Hz, 0.5-mm single amplitude (1.0-mm double amplitude)	
	Malfunction	10 to 55 to 10 Hz, 0.5-mm single amplitude (1.0-mm double amplitude)	
Shock resistance	Destruction	1,000 m/s <sup>2</sup>	
	Malfunction	200 m/s <sup>2</sup>	
Endurance	Mechanical	AC: 50,000,000 operations min. DC: 100,000,000 operations min. (switching frequency: 18,000 operations/h)	
	Electrical <sup>*4</sup>	500,000 operations min. (rated load, switching frequency: 1,800 operations/h)	200,000 operations min. (rated load, switching frequency: 1,800 operations/h)

Item	Number of poles	2 or 3 poles	4 poles
Failure rate P value (reference value)		1 mA at 5 VDC	1 mA at 1 VDC
Weight		Approx. 35 g	

Note: These are initial values.

\*1. Measurement conditions: 1 A at 5 VDC using the voltage drop method

\*2. Measurement conditions: With rated operating power applied. Ambient temperature condition: 23° C

\*3. Measurement conditions: For 500 VDC applied to the same location as for dielectric strength measurement.

\*4. Ambient temperature condition: 23° C

\*5. This value was measured at a switching frequency of 120 operations per minute.

# MY(S)

## Dimensions

(Unit: mm)

### Case-surface mounting MY□F



The above figure is for the MY4F.

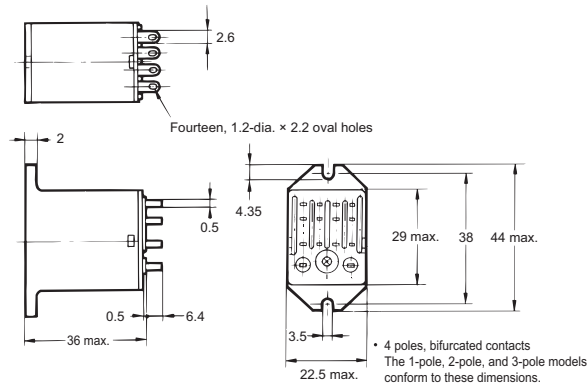

### Mounting Hole Dimensions

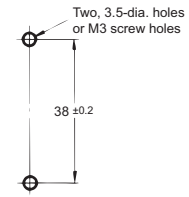

**Note:** Refer to the terminal arrangement and internal connections diagrams for the MY2, MY3, MY4, and MY4Z.

# Miniature Power Relays: MY4Z-CBG

## Ratings and Specifications

### Ratings

#### Contact Ratings

Item	Load	Resistive load	Inductive load ( $\cos \phi = 0.4, L/R = 7 \text{ ms}$ )
Rated load		1 A at 220 VAC 1 A at 24 VDC	0.3 A at 220 VAC 0.5 A at 24 VDC
Rated carry current		1 A	
Maximum contact voltage		250 VAC, 125 VDC	
Maximum contact current		1 A	
Contact structure		Crossbar bifurcated	
Contact materials		Au cladding + AgPd	

### Characteristics

Contact resistance <sup>*1</sup>		100 mΩ max.
Operation time <sup>*2</sup>		20 ms max.
Release time <sup>*2</sup>		20 ms max.
Maximum operating frequency	Mechanical	18,000 operations/h
	Electrical	1,800 operations/h
Insulation resistance <sup>*3</sup>		100 MΩ
Dielectric strength	Between coil and contacts	2,000 VAC at 50/60 Hz for 1 min.
	Between contacts of different polarity	
	Between contacts of the same polarity	700 VAC at 50/60 Hz for 1 min.
Vibration resistance	Destruction	10 to 55 to 10 Hz, 0.5-mm single amplitude (1.0-mm double amplitude)
	Malfunction	10 to 55 to 10 Hz, 0.5-mm single amplitude (1.0-mm double amplitude)
Shock resistance	Destruction	1,000 m/s <sup>2</sup>
	Malfunction	200 m/s <sup>2</sup>
Endurance	Mechanical	5,000,000 operations min. (operating frequency: 18,000 operations/hr)
	Electrical <sup>*4</sup>	50,000 operations min. (switching frequency: 1,800 operations/h) at rated load
Failure rate P value (reference value) <sup>*5</sup>		100 μA at 1 VDC
Ambient operating temperature		-25 to 70°C (with no icing or condensation)
Ambient operating humidity		5% to 85%
Weight		Approx. 35 g

Note: The above values are initial values.

- \*1. Measurement conditions: 1 A at 5 VDC using the voltage drop method
- \*2. Measurement conditions: With rated operating power applied, not including contact bounce. Ambient temperature condition: 23° C
- \*3. Measurement conditions: For 500 VDC applied to the same location as for dielectric strength measurement.
- \*4. Ambient temperature condition: 23° C
- \*5. This value was measured at a switching frequency of 120 operations per minute.

## Engineering Data

### Engineering Data

#### Maximum Switching Capacity

#### MY4Z-CBG

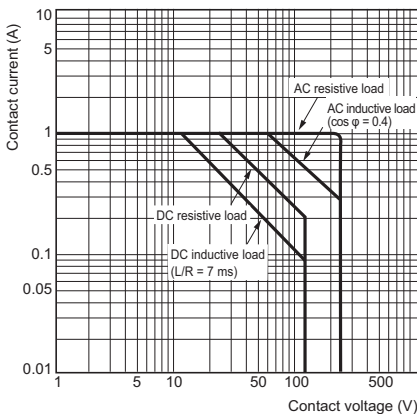

#### Contact Reliability Test (Modified Allen Bradley Circuit)

Contact load: 5 VDC, 1 mA resistive load  
Malfunction criteria level: Contact resistance of 100 Ω

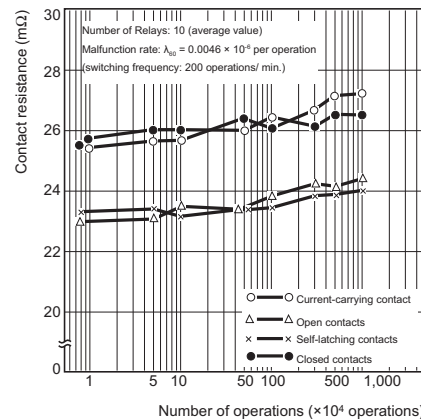

# MY(S)

## Dimensions

(Unit: mm)

### MY4Z-CBG

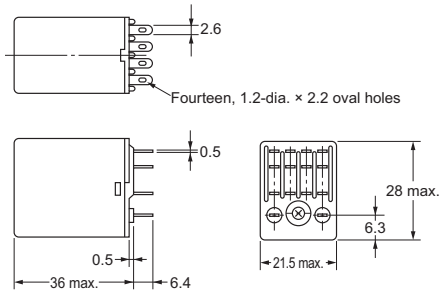
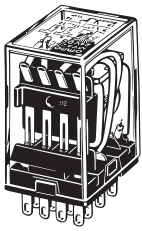

### Terminal Arrangement/Internal Connections (Bottom View) Standard Models

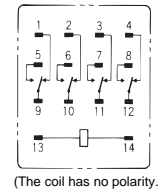

## Safety Precautions

Refer to the *Common Relay Precautions*.

### Applicable Sockets

Use only combinations of OMRON Relays and Sockets.



# Plastic Sealed Relays: MYQ

## Ratings and Specifications

### Ratings

#### Contact Ratings

Item	Type	Resistive load	Inductive load ( $\cos \varphi = 0.4, L/R = 7 \text{ ms}$ )
Rated load		1 A at 220 VAC, 1 A at 24 VDC	0.5 A at 220 VAC, 0.5 A at 24 VDC
Rated carry current		1 A	
Maximum contact voltage		250 VAC, 125 VDC	
Maximum contact current		1 A	
Maximum switching capacity (reference value)		220 VAC, 24 W	110 VAC, 12 W
Failure rate P value (reference value)		Single contacts: 1 mA at 1 VDC, Bifurcated contacts: 100 $\mu\text{A}$ at 1 VDC	
Contact structure		Single/bifurcated	
Contact materials		Au plating + Ag	

\* This value was measured at a switching frequency of 120 operations per minute.

Ambient operating temperature	-55 to 60° C*
Ambient operating humidity	5% to 85%

\* With no icing or condensation.

### Characteristics

Contact resistance <sup>1</sup>		50 m $\Omega$ max.
Operation time <sup>2</sup>		20 ms max.
Release time <sup>2</sup>		20 ms max.
Maximum operating frequency	Mechanical	18,000 operations/h
	Rated load	1,800 operations/h
Dielectric strength	Between coil and contacts	1,500 VAC at 50/60 Hz for 1 min.
	Between contacts of different polarity	1,500 VAC at 50/60 Hz for 1 min.
	Between contacts of the same polarity	1,000 VAC at 50/60 Hz for 1 min.
Insulation resistance <sup>3</sup>		100 M $\Omega$ min.
Vibration resistance	Destruction	10 to 55 to 10 Hz, 0.5-mm single amplitude (1.0-mm double amplitude)
	Malfunction	10 to 55 to 10 Hz, 0.5-mm single amplitude (1.0-mm double amplitude)
Shock resistance	Destruction	1,000 m/s <sup>2</sup>
	Malfunction	200 m/s <sup>2</sup>
Endurance	Mechanical	AC: 50,000,000 operations (5,000,000 <sup>4</sup> ) min., DC: 100,000,000 operations (5,000,000 <sup>4</sup> ) min. (switching frequency: 18,000 operations/h)
	Electrical <sup>5</sup>	200,000 operations min. (100,000 operations <sup>4</sup> ) (rated load, switching frequency: 1,800 operations/h)
Weight		Approx. 35 g

**Note:** The values at the left are initial values.

- \*1. Measurement conditions: 1 A at 5 VDC using the voltage drop method
- \*2. Measurement conditions: With rated operating power applied, not including contact bounce. Ambient temperature condition: 23° C
- \*3. Measurement conditions: For 500 VDC applied to the same location as for dielectric strength measurement.
- \*4. This value is for bifurcated contacts.
- \*5. Ambient temperature condition: 23° C

## Engineering Data

### Engineering Data

#### Maximum Switching Capacity MYQ4(Z)

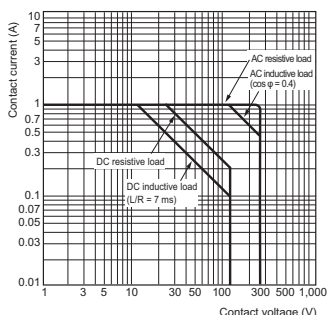

#### Endurance Curve MYQ4

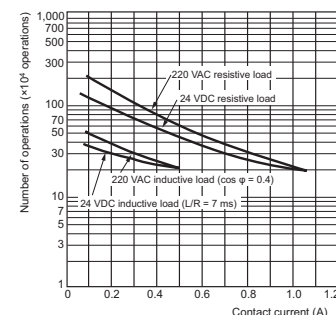

**Note:** The durability of bifurcated contacts is one-half that of single contacts.

#### H<sub>2</sub>S Gas Data MYQ4

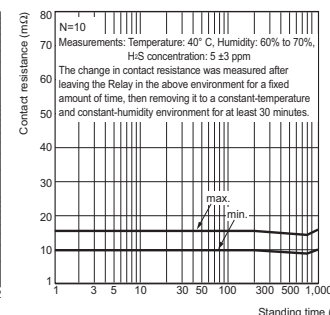

#### Malfunctioning Shock

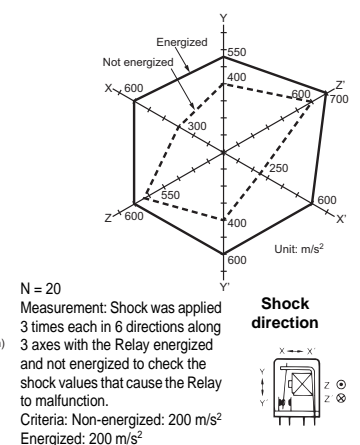

# MY(S)

## Dimensions

(Unit: mm)

### Relays with Plug-in Terminals or Soldered Terminals MYQ4(Z)(N)

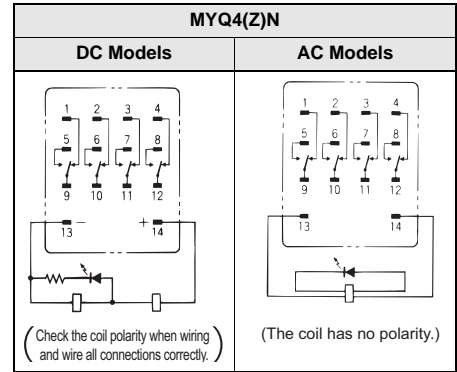
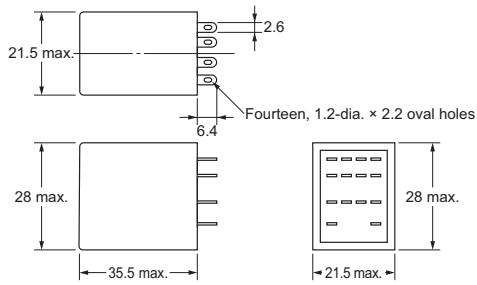
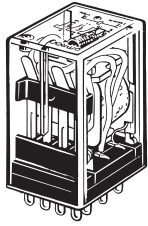

- Note:**
1. An AC model has coil disconnection self-diagnosis.
  2. For the DC models, check the coil polarity when wiring and wire all connections correctly.

### Relays with PCB Terminals MYQ4(Z)-02

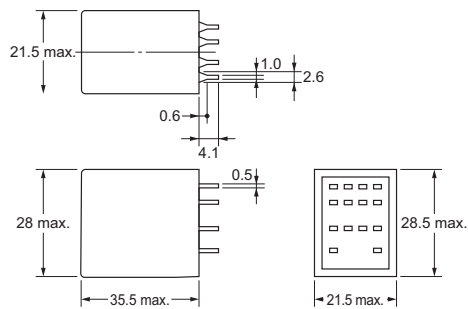
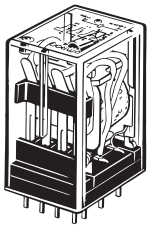

#### PCB Processing Dimensions (Bottom View)

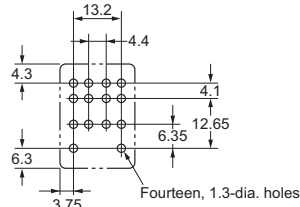

**Note:** The dimensional tolerance is  $\pm 0.1$ .

#### Terminal Arrangement/Internal Connections (Bottom View) Standard Models

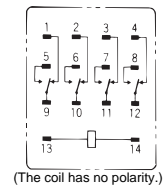

## Safety Precautions

- For models with built-in operation indicators, check the coil polarity when wiring and wire all connections correctly (DC operation).
- Use only combinations of OMRON Relays and Sockets.
- The UL and CSA certifications for this model are the same as for the MY4-02.

## Relay Replacement

To replace the Relay, turn OFF the power supply to the load and Relay coil sides to prevent unintended operation and possible electrical shock.

# Latching Relays MYK

## Ratings and Specifications

### Ratings

#### Operating Coil

Item	Rated voltage (V)	Set coil			Reset coil			Set voltage (V)	Reset voltage (V)	Maximum voltage (V)	Power consumption (VA, W)	
		Rated current (mA)		Coil resistance ( $\Omega$ )	Rated current (mA)		Coil resistance ( $\Omega$ )				Set coil	Reset coil
		50 Hz	60 Hz		50 Hz	60 Hz						
AC	12	57	56	72	39	38.2	130	80% max.	80% max.	110% max. of rated voltage	Approx. 0.6 to 0.9 (at 60 Hz)	Approx. 0.2 to 0.5 (at 60 Hz)
	24	27.4	26.4	320	18.6	18.1	550					
	100	7.1	6.9	5,400	3.5	3.4	3,000					
DC	12	110		110	50		235	80% max.	80% max.	110% max. of rated voltage	Approx. 1.3	Approx. 0.6
	24	52		470	25		940					
	48	27		1,800	16		3,000					

- Note:**
1. The rated current for AC is the value measured with a DC ammeter in half-wave rectification.
  2. The rated current and coil resistance are measured at a coil temperature of 23°C with tolerances of +15%/–20% for the AC rated current and  $\pm$ 15% for the DC coil resistance.
  3. The AC coil resistance is a reference value only.
  4. Operating characteristics were measured at a coil temperature of 23°C.
  5. The maximum voltage capacity was measured at an ambient temperature of 23°C.

#### Contact Ratings

Item	Load	Resistive load	Inductive load ( $\cos \phi = 0.4$ , L/R = 7 ms)
Rated load		3 A at 220 VAC 3 A at 24 VDC	0.8 A at 220 VAC 1.5 A at 24 VDC
Rated carry current		3 A	
Maximum contact voltage		250 VAC, 125 VDC	
Maximum contact current		3 A	
Contact structure		Single	
Contact materials		Au plating + Ag	
Ambient operating temperature		–55 to 60° C*	
Ambient operating humidity		5% to 85%	

\* With no icing or condensation.

#### Characteristics

Contact resistance <sup>1</sup>		50 m $\Omega$ max.
Set	Time <sup>2</sup>	AC: 30 ms max., DC: 15 ms max.
	Minimum pulse width	AC: 60 ms, DC: 30 ms
Reset	Time <sup>2</sup>	AC: 30 ms max., DC: 15 ms max.
	Minimum pulse width	AC: 60 ms, DC: 30 ms
Maximum operating frequency	Mechanical	18,000 operations/h
	Rated load	1,800 operations/h
Insulation resistance <sup>3</sup>		100 M $\Omega$
Dielectric strength	Between coil and contacts	1,500 VAC at 50/60 Hz for 1 min.
	Between contacts of different polarity	
	Between contacts of the same polarity	1,000 VAC at 50/60 Hz for 1 min.
Between set/reset coils		
Vibration resistance	Destruction	10 to 55 to 10 Hz, 0.5-mm single amplitude (1.0-mm double amplitude)
	Malfunction	10 to 55 to 10 Hz, 0.5-mm single amplitude (1.0-mm double amplitude)
Shock resistance	Destruction	1,000 m/s <sup>2</sup>
	Malfunction	200 m/s <sup>2</sup>
Endurance	Mechanical	100,000,000 operations min. (switching frequency: 18,000 operations/h)
	Electrical <sup>4</sup>	200,000 operations min. (at 1,800 operations/hr, rated load)
Failure rate P value (reference value) <sup>5</sup>		1 mA at 1 VDC
Weight		Approx. 30 g

**Note:** The above values are initial values.

- \*1. Measurement conditions: 1 A at 5 VDC using the voltage drop method
- \*2. Measurement conditions: With rated operating power applied, not including contact bounce.
- \*3. Measurement conditions: For 500 VDC applied to the same location as for dielectric strength measurement.
- \*4. Ambient temperature condition: 23° C
- \*5. This value was measured at a switching frequency of 120 operations per minute.

# MY(S) Engineering Data

## Engineering Data

### MY2K(-02)

#### Maximum Switching Capacity

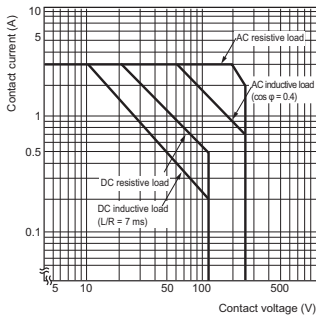

#### Endurance Curve

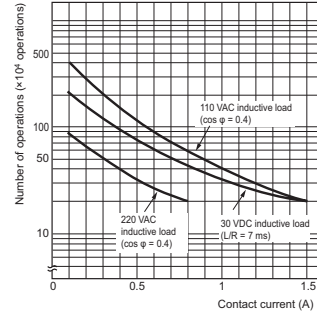
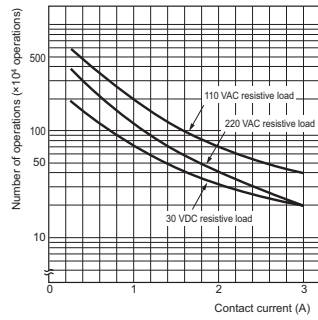

#### MY2K 100 VAC Malfunctioning Shock

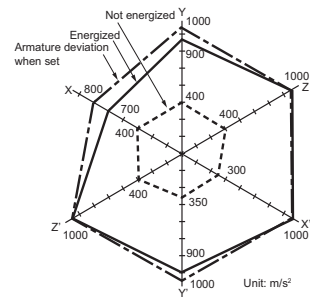

**N = 20**  
Measurement: Shock was applied 2 times each in 6 directions along 3 axes with the Relay energized and not energized to check the shock values that cause the Relay to malfunction.

Criteria: Non-energized: 200 m/s<sup>2</sup>  
Energized: 200 m/s<sup>2</sup>

#### MY2K 24 VDC Magnetic Interference (External Magnetic Field)

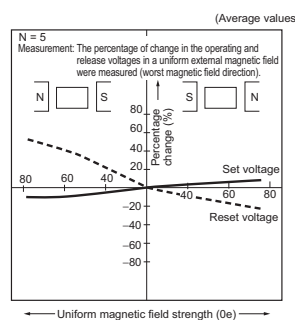

#### Latching Deterioration Over Time

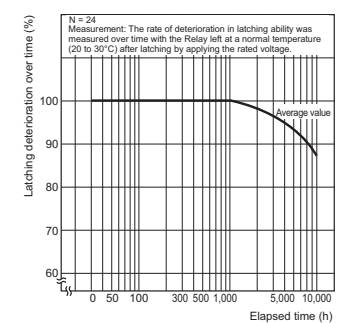

## Dimensions

(Unit: mm)

#### Relays with Plug-in Terminals or Soldered Terminals MY2K

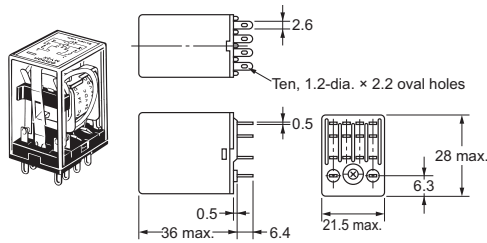

#### Terminal Arrangement/Internal Connections (Bottom View)

##### For AC

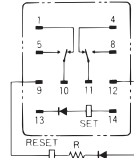

**Note:** R is a resistor for ampere-turn correction. This resistor is built-in to 50-VAC and higher models. (The coil has no polarity.)

## Safety Precautions

- For applications that use a 200 VAC power supply, connect external resistors  $R_s$  and  $R_r$  to a 100 VAC Relay.

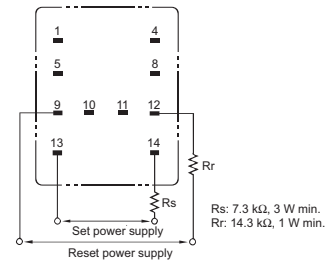

#### Relays with PCB Terminals MY2K-02

#### PCB Processing Dimensions (Bottom View)

**Note:** The dimensional tolerance is  $\pm 0.1$ .

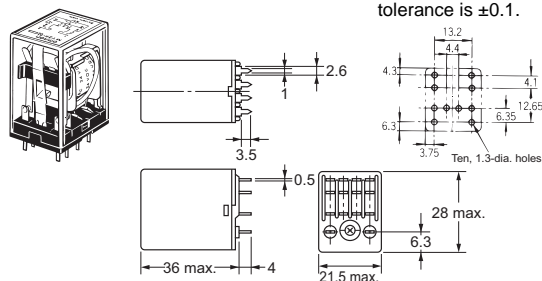

##### For DC

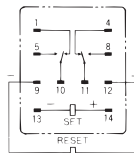

**Note:** Pay close attention to the set coil and reset coil polarities. If the connections are not correct, unintended operation may occur.

- Do not apply a voltage to the set and reset coils at the same time. If you apply the rated voltage to both coils simultaneously, the Relay will be set.
- The minimum pulse width in the performance column is the value for the following measurement conditions: an ambient temperature of 23°C with the rated operating voltage applied to the coil. The performance values given here may not be satisfied due to use over time and a reduction in latching performance due to changes in the ambient temperature or in the conditions of the application circuit. For actual use, apply the rated operating voltage with a pulse width based on the actual load and reset the Relay at least once per year to prevent degradation over time.
- If the Relay is used in an environment with strong magnetic fields, the surrounding magnetic field can demagnetize the magnetic body and cause unintended operation. Therefore, do not use these Relays in environments with strong magnetic fields.

#### Relay Replacement

To replace the Relay, turn off the power supply to the load and Relay coil sides to prevent unintended operation and possible electrical shock.

#### Applicable Sockets

Use only combinations of OMRON Relays and Sockets.

# Hermetically Sealed Relays: MYH

## Ratings and Specifications

### Ratings

#### Contact Ratings

Item	Load	Models with single contacts		Bifurcated contacts	
		Resistive load	Inductive load cos φ = 0.4 L/R = 7 ms	Resistive load	Inductive load cos φ = 0.4 L/R = 7 ms
<b>Rated load</b>		3 A at 110 VAC 3 A at 24 VDC	0.8 A at 110 VAC 1.5 A at 24 VDC	3 A at 110 VAC 3 A at 24 VDC	0.8 A at 110 VAC 1.5 A at 24 VDC
<b>Rated carry current</b>		3 A			
<b>Maximum contact voltage</b>		125 VAC 125 VDC			
<b>Maximum contact current</b>		3 A			
<b>Contact structure</b>		Single		Bifurcated	
<b>Contact materials</b>		Au plating + Ag			
<b>Ambient operating temperature</b>		-25 to 60° C*			
<b>Ambient operating humidity</b>		5% to 85%			

\* With no icing or condensation.

### Characteristics

<b>Contact resistance<sup>1</sup></b>	50 mΩ max.	
<b>Operation time<sup>2</sup></b>	20 ms max.	
<b>Release time<sup>2</sup></b>	20 ms max.	
<b>Maximum operating frequency</b>	<b>Mechanical</b>	18,000 operations/h
	<b>Rated load</b>	1,800 operations/h
<b>Insulation resistance<sup>4</sup></b>	100 MΩ min.	
<b>Dielectric strength</b>	<b>Between coil and contacts</b>	1,000 VAC at 50/60 Hz for 1 min. (700 VAC between contacts of the same polarity.)
	<b>Between contacts of different polarity</b>	
<b>Vibration resistance</b>	<b>Destruction</b>	10 to 55 to 10 Hz, 0.5-mm single amplitude (1.0-mm double amplitude)
	<b>Malfunction</b>	10 to 55 to 10 Hz, 0.5-mm single amplitude (1.0-mm double amplitude)
<b>Shock resistance</b>	<b>Destruction</b>	1,000 m/s <sup>2</sup>
	<b>Malfunction</b>	200 m/s <sup>2</sup>
<b>Endurance</b>	<b>Mechanical</b>	50,000,000 operations (5,000,000 operations <sup>4</sup> ) min. (operating frequency: 18,000 operations/h)
	<b>Electrical<sup>5</sup></b>	100,000 operations (50,000 operations <sup>4</sup> ) min. rated load, switching frequency: 1,800 operations/h
<b>Failure rate P value (reference value)<sup>6</sup></b>	Single contacts: 100 μA at 1 VDC Bifurcated contacts: 100 μA at 100 mVDC	
<b>Weight</b>	Approx. 50 g	

**Note:** The above values are initial values.

- \*1. Measurement conditions: 1 A at 5 VDC using the voltage drop method
- \*2. Measurement conditions: With rated operating power applied, not including contact bounce.  
Ambient temperature condition: 23° C
- \*3. Measurement conditions: For 500 VDC applied to the same location as for dielectric strength measurement.
- \*4. This value is for bifurcated contacts.
- \*5. Ambient temperature condition: 23° C
- \*6. This value was measured at a switching frequency of 120 operations per minute.

## Engineering Data

### Engineering Data

#### Maximum Switching Capacity MY4(Z)H

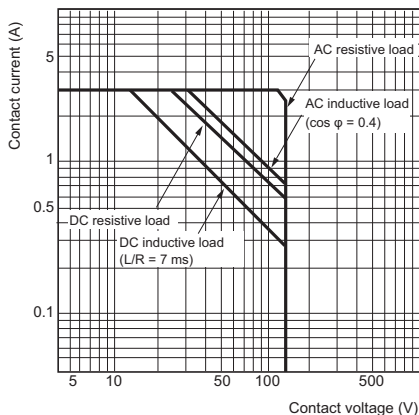

#### Endurance Curve MY4H

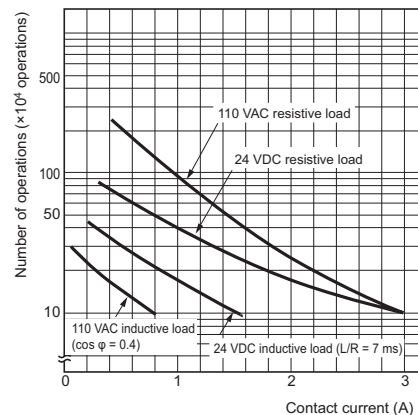

**Note:** The durability of bifurcated contacts is one-half that of single contacts.

# MY(S)

## Dimensions

(Unit: mm)

### Relays with Plug-in Terminals or Soldered Terminals

#### MY4(Z)H

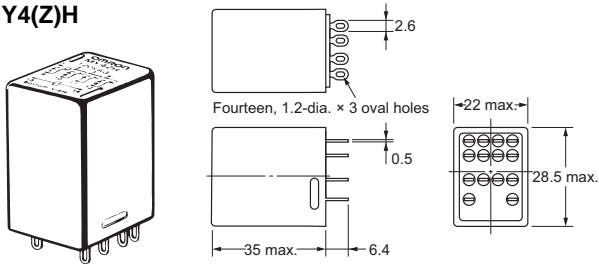

### Terminal Arrangement/ Internal Connections (Bottom View)

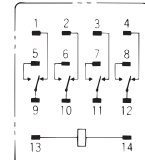

(The coil has no polarity.)

### Relays with PCB Terminals

#### MY4(Z)H-0

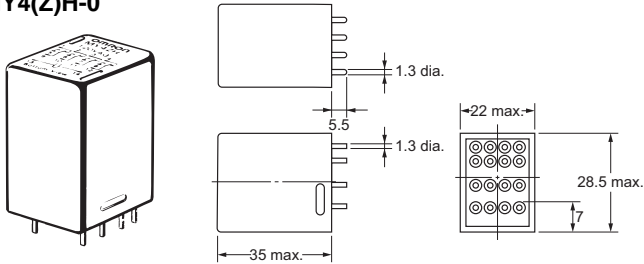

### PCB Processing Dimensions (Bottom View)

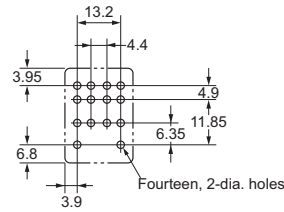

## Safety Precautions

### PCB Design for Hermetically Sealed Relays

When a Relay with PCB Terminals is mounted, a short-circuit can occur depending on the design of the PCB pattern because the Relay itself is made out of metal.

#### Solution

Refer to the external dimensions of the Relay and design the PCB pattern with enough space to prevent this problem.

### Applicable Sockets

Use only combinations of OMRON Relays and Sockets.

### Application Environment for Hermetically Sealed Relays

Humid environments can cause insulation problems, which may result in short-circuiting or unintended operation.

#### Solution

Do not use these Relays in any environment where the Relay will come into contact with water vapor, condensation, or water droplets. This can reduce the surface tension of the insulating beads and cause short-circuiting or unintended operation due to poor insulation.

### Relay Replacement

To replace the Relay, turn OFF the power supply to the load and Relay coil sides to prevent unintended operation and possible electrical shock.

# Engineering Data MY3, MY□-02, and MY□F

## Engineering Data

### Maximum Switching Capacity MY2 and MY3

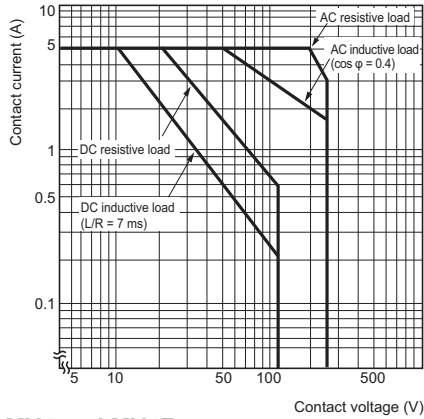

### MY4 and MY4Z

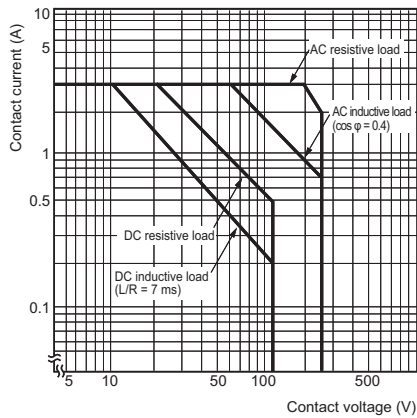

### Endurance Curve MY2 and MY3

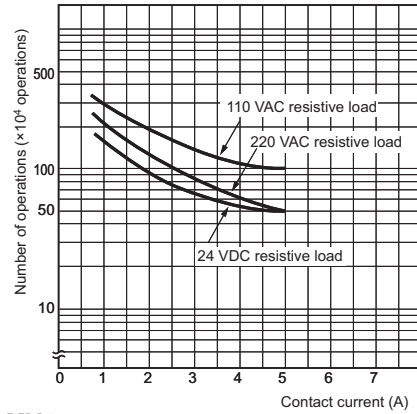

### MY2 and MY3

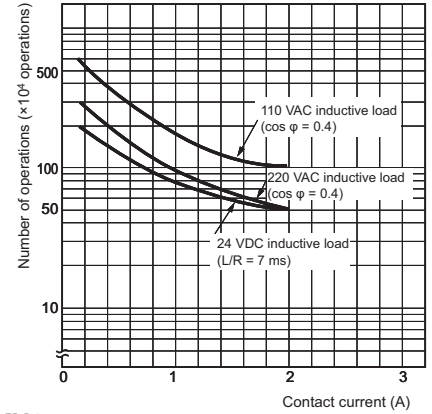

### MY4

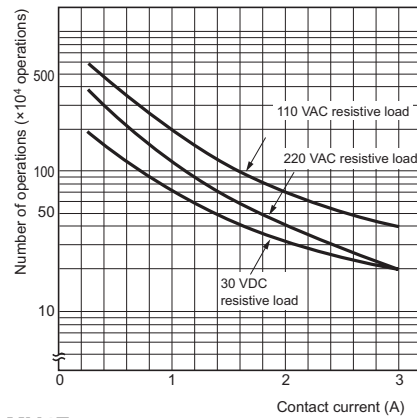

### MY4

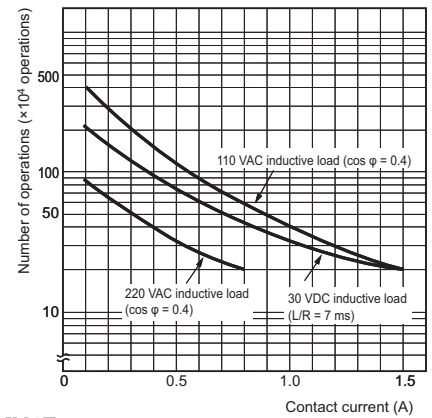

### MY4Z

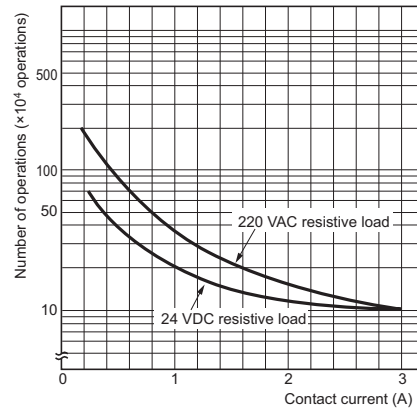

### MY4Z

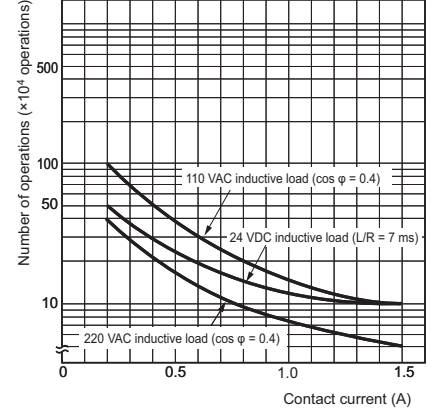

## Common Specifications for MY3, MY□-02, MY□F, and MY(S)

### Malfunctioning Shock

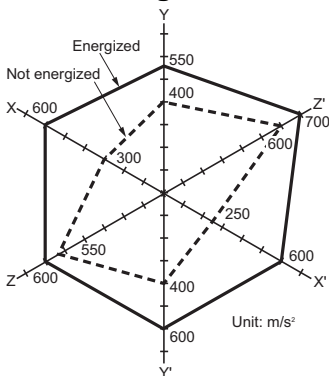

N = 20

Measurement: Shock was applied 3 times each in 6 directions along 3 axes with the Relay energized and not energized to check the shock values that cause the Relay to malfunction.

Criteria: Non-energized: 200 m/s<sup>2</sup>,

Energized: 200 m/s<sup>2</sup>

### Shock direction

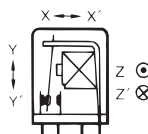

## Ambient Temperature vs. Must-operate and Must-release Voltage MY2 AC Models

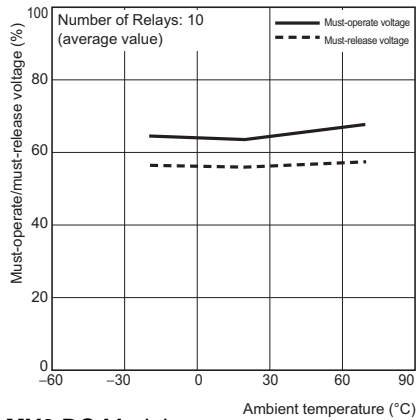

## MY2 DC Models

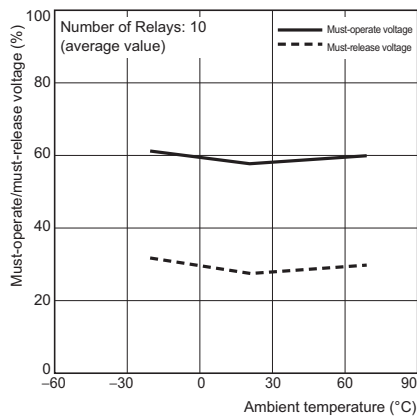

## MY4 AC Models

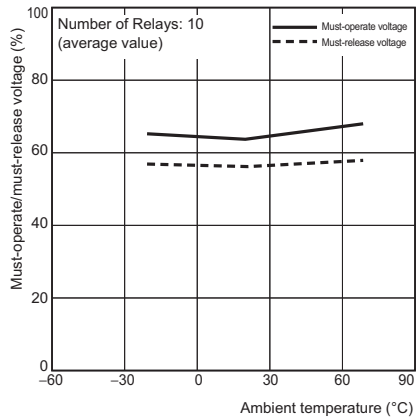

## MY4 DC Models

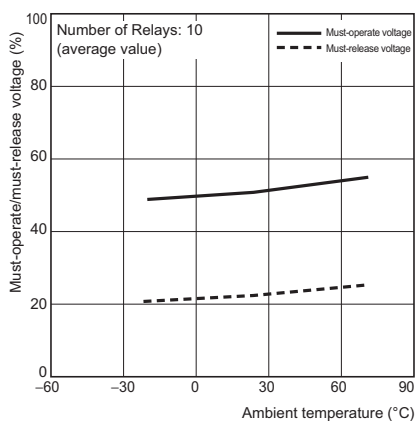

## Ambient Temperature vs. Coil Temperature Rise

### MY2 AC Models, 50 Hz

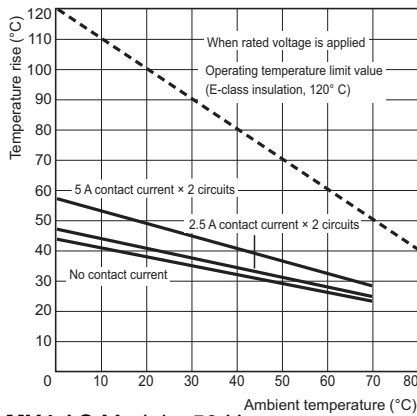

### MY2 DC Models

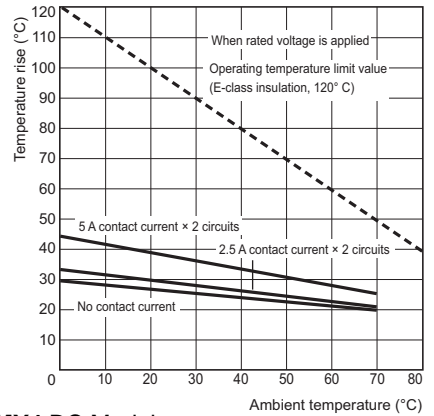

### MY4 AC Models, 50 Hz

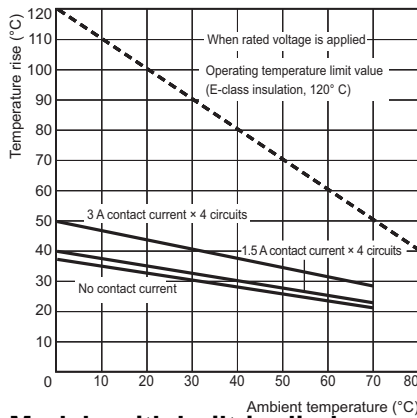

### MY4 DC Models

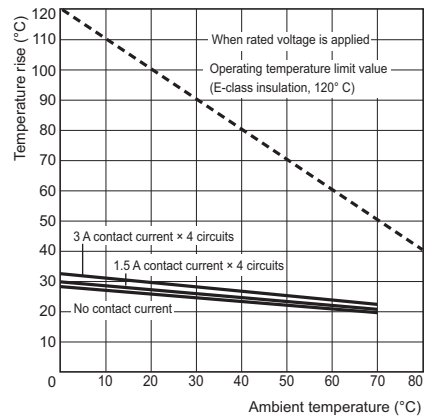

## Models with built-in diodes

The diode absorbs surge from the coil. This type is best suited for applications with semiconductor circuits.

### With Diode

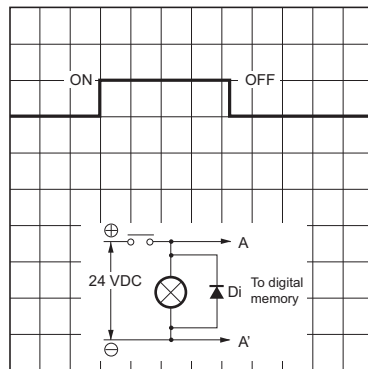

- Note:**
1. Make sure that the polarity is correct.
  2. The release time will increase, but the 20-ms specification for standard models is satisfied.
  3. Diode properties: The diode has a reversed dielectric strength of 1,000 V. Forward current: 1 A

### Without Diode

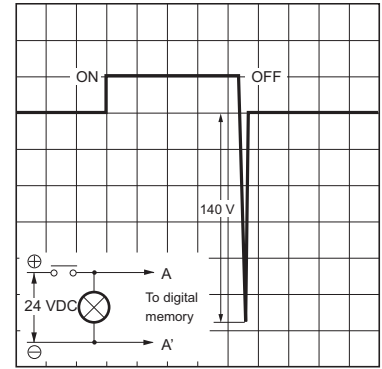

## Models with Built-in CR Circuits

### With CR

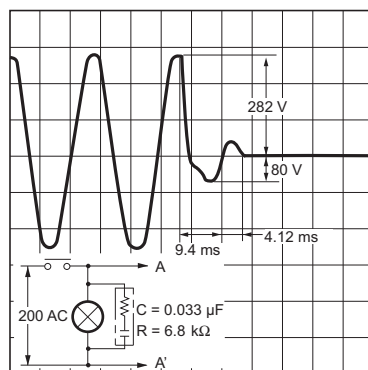

### Without CR

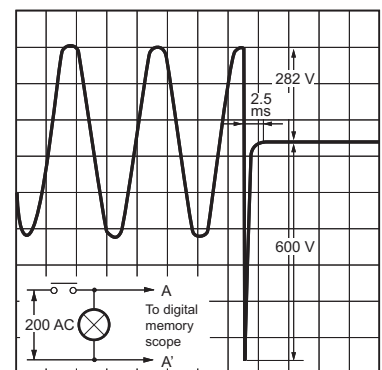



**Detailed Information on Models Certified for Safety Standards, MY2Z, MY3, MY□-02, and MY□F**

- The standard models are certified for UL and CSA standards.
- The rated values for safety standard certification are not the same as individually defined performance values. Always check the specifications before use.

**TÜV-certified Models (File No. R50030059)** 

Model	Number of poles	Coil ratings	Contact ratings	Certified number of operations
MY□	2	6 to 125 VDC 6 to 240 VDC	5 A, 250 VAC (cos φ = 1.0)	10,000 operations
	3		5 A, 250 VAC (cos φ = 1.0) 0.8 A, 250 VAC (cos φ = 0.4)	
	4		3 A, 120 VAC (cos φ = 1.0) 0.8 A, 120 VAC (cos φ = 0.4)	

**UL-certified Models (File No. E41515)** 

Model	Number of poles	Coil ratings	Contact ratings	Certified number of operations	
MY□	2	6 to 240 VAC 6 to 125 VDC	7A, 240 VAC (General Use)	6,000	
			7A, 24 VDC (Resistive)		
			5A, 240 VAC (General Use)		
			5A, 250 VAC (Resistive)		
			5A, 30 VDC (Resistive)		
			3A, 265 VAC (Resistive)		
			1/6HP, 250 VAC		1,000
			1/8HP, 265 VAC		
			1/10HP, 120 VAC		
			B300 Pilot Duty		6,000
	3		5A, 28 VDC (Resistive)	6,000	
			5A, 240 VAC (General Use)	6,000	
			1/6 HP, 250 VAC	1,000	
	4		5A, 28 VDC (General Use) (Same polarity)	6,000	
			5A, 240 VAC (General Use) (Same polarity)		
			5A, 30 VDC (Resistive) (Same polarity)		
			5A, 250 VAC (Resistive) (Same polarity)		
			0.2A, 120 VDC (Resistive) (Same polarity)		
			1/6HP, 250 VAC (Same polarity)		1,000
			1/10HP, 120 VAC (Same polarity)		
B300 Pilot Duty (Same polarity)	6,000				

**CSA-certified Models (File No. LR31928)** 

Model	Number of poles	Coil ratings	Contact ratings	Certified number of operations	
MY□	2	6 to 240 VAC 6 to 125 VDC	7A, 240 VAC (Resistive)	6,000	
			7A, 24 VDC (Resistive)		
			5A, 240 VAC (General Use)		
			5A, 250 VAC (Resistive)		
			5A, 30 VDC (Resistive)		
			1/6HP, 250 VAC		1,000
	1/10HP, 120 VAC				
	3		5A, 28 VDC (Resistive)	6,000	
			7A, 240 VAC (General Use)		
			7A, 24 VDC (Resistive)		
			5A, 240 VAC (General Use)		
			1/6HP, 250 VAC		1,000
			4		7A, 240 VAC (General Use) (Same polarity)
	7A, 24 VDC (Resistive) (Same polarity)				
	5A, 240 VAC (General Use) (Same polarity)				
	5A, 30 VDC (Resistive)				
	5A, 250 VAC (Resistive) (Same polarity)				
	0.2A, 120 VDC (Resistive)			1,000	
1/6HP, 250 VAC					
1/10HP, 120 VAC	1,000				

- When ordering models that are certified for Lloyd's Register (LR) Standards, be sure to specify "LR-certified Model" with your order.

**LR-certified Models (File No. 90/10270)**

Model	Number of poles	Coil ratings	Contact ratings
MY□	2	6 to 240 VAC 6 to 125 VDC	2 A, 30 VDC inductive load 2 A, 200 VAC inductive load
	4		1.5 A, 30 VDC inductive load 0.8 A, 200 VAC inductive load 1.5 A, 115 VAC inductive load

# Sockets for MY

## DIN-rail-mounted (DIN-rail) Socket Conforms to VDE 0106, Part 100

- Snap into position along continuous sections of any mounting DIN-rail.
- Facilitates sheet metal design by standardized mounting dimensions.
- Design with sufficient dielectric separation between terminals eliminates the need of any insulating sheet.

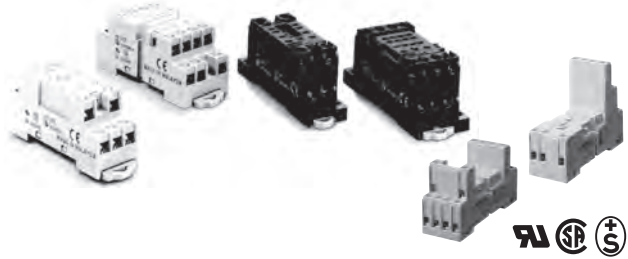

## Safety Standards for Sockets

Model	Standards	File No.
PYF08A-E, PYF08A-N PYF14A-E, PYF14A-N	UL508	E87929
	CSA22.2	LR31928
PYF14-ESN, PYF14-ESS	UL508	E244189
	CSA22.2	LR225761

## Back-connecting Sockets

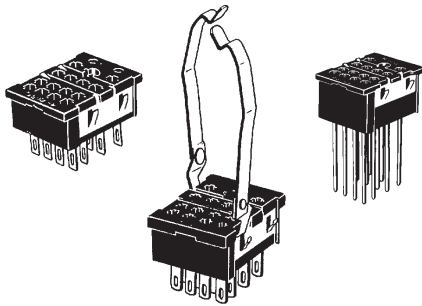

## Specifications

Item	Pole	Model	Carry current	Dielectric withstand voltage	Insulation resistance (see note 2)
Screwless Clamp Terminal Socket	2	PYF08S	10 A	2,000 VAC, 1 min	Less than 1,000 MΩ
	4	PYF14S	5 A		
DIN-rail-mounted Socket	2	PYF08A-E	7 A	2,000 VAC, 1 min	1,000 MΩ min.
		PYF08A-N (see note 3)	7 A (see note 4)		
	4	PYF14A-E	5 A		
	4	PYF14A-N (see note 3)	5 A (see note 4)		
	4	PYF14-ESN/-ESS	12 A	> 3 kV	> 5 MΩ
Back-connecting Socket	2	PY08(-Y1)	7 A	1,500 VAC, 1 min	100 MΩ min.
		PY08QN(-Y1)			
		PY08-02			
	4	PY14(-Y1)	3 A		
		PY14QN(-Y1)			
		PY14-02			

- Note:**
1. The values given above are initial values.
  2. The values for insulation resistance were measured at 500 V at the same place as the dielectric strength.
  3. The maximum operating ambient temperature for the PYF08A-N and PYF14A-N is 55°C.
  4. When using the PYF08A-N or PYF14A-N at an operating ambient temperature exceeding 40°C, reduce the current to 60%.
  5. The MY2(S) can be used at 70°C with a carry current of 7 A.

**Options (Order Separately)**  
**Connection Socket and Mounting Bracket Selection Table**

Type	Front-mounting Sockets				Back-mounting Sockets						Relays with PCB Terminals
	Track or screw mounting		Screw mounting only	Screwless Socket	Solder terminals		Wrapping terminals				
	---	Terminal cover structure	---		Without Mounting Brackets	With Mounting Brackets	Without Mounting Brackets		With Mounting Brackets		
	Screw terminal size: M3		Screw terminal size: M3.5				Terminal length: 25 mm	Terminal length: 20 mm	Terminal length: 25 mm	Terminal length: 20 mm	
Model											
MY2□ MY2(S)	PYF08A (PYC-A1)	PYF08A-E (PYC-A1)	PYF08M (PYC-P)	PYF08S	PY08 (PYC-P)	PY08-Y1	PY08QN (PYC-P)	PY08QN2 (PYC-P)	PY08QN-Y1	PY08QN2-Y1	PY08-02 (PYC-P)
MY2Z□-CR	PYF08A (Y92H-3)	PYF08A-E (Y92H-3)			PY08 (PYC-1)	PY08-Y3	PY08QN (PYC-1)	PY08QN2 (PYC-1)			PY08-02 (PYC-1)
MY3□	PYF11A (PYC-A1)				PY11 (PYC-P)	PY11-Y1	PY11QN (PYC-P)	PY11QN2 (PYC-P)	PY11QN-Y1	PY11QN2-Y1	PY11-02 (PYC-P)
MY4□ MY4(S) MY4Z□ MY4Z-CBG MYQ4□ MY4H MY4ZH MY2K□	Screw terminal size: M3			PYF14S	PY14 (PYC-P)	PY14-Y1	PY14QN (PYC-P)	PY14QN2 (PYC-P)	PY14QN-Y1	PY14QN2-Y1	PY14-02 (PYC-P)
	PYF14A (PYC-A1)										
	Screw terminal size: M3.5		PYF14A-E (PYC-A1)								

- Note:**
- The information in parentheses is the model number of the applicable Mounting Bracket. Mounting Brackets are sold in sets of two. However, the PYC-P is just one Mounting Bracket.
  - The PYF□A-E has a terminal cover with finger protection. Round terminals cannot be used. Use forked terminals or ferrules instead.
  - Refer to *Common Socket and DIN Track Products* for the external dimensions of the Socket Relays.
  - The Mounting Brackets are applicable for Relays with a height of 36 mm or less. If the Relay height is greater than 53 mm, use Y92H-3 for the Front-mounting Socket and PYC-1 for the Back-mounting Socket. (The Y92H-3 is a set of two Brackets and the PYC-1 is just one Bracket.)
  - Refer to *PYF□S/P2RF-□S* for details on Screwless Sockets.
  - The terminal cover is integrated into the Socket.
  - If an MY□(S) Relay with a Latching Lever is used in combination with a PY□□-02 Socket for Relays with PCB Terminals and a PYC-P Mounting Brackets, the lever will not operate.
  - We recommend using the PYC-E1 Mounting Bracket for a MY2(S) Relay with Latching Lever. (If the PYC-A1 is used with the MY2(S), the latching lever will be blocked by the Mounting Bracket and the lever will not operate.)

**Mounting Plates for Sockets**

Socket model	For 1 Socket	For 18 Sockets	For 36 Sockets
PY08, PY08QN(2), PY14, PY14QN(2)	PYP-1	PYP-18	PYP-36

**Note:** PYP-18 and PYP-36 can be cut into any desired length in accordance with the number of Sockets.

**DIN-rail and Accessories**

Supporting DIN-rail (length = 500 mm)	PFP-50N
Supporting DIN-rail (length = 1,000 mm) PFP	PFP-100N, PFP-100N2
End Plate	PFP-M
Spacer	PFP-S

**Mounting Heights with Sockets (Unit: mm)**

**Front-mounting Sockets**

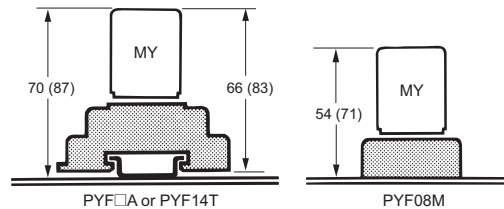

**Back-mounting Sockets**

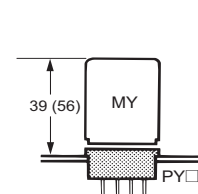

**Screwless Sockets**

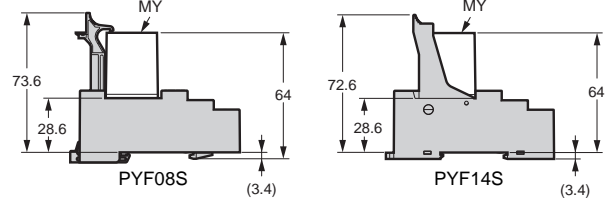



- Note:**
- The PYF□A can be mounted on a track or with screws.
  - The heights given in parentheses are the measurements for 53-mm-high Relays.
  - Use the PYC-P Mounting Bracket for the PYF08M.

## Dimensions

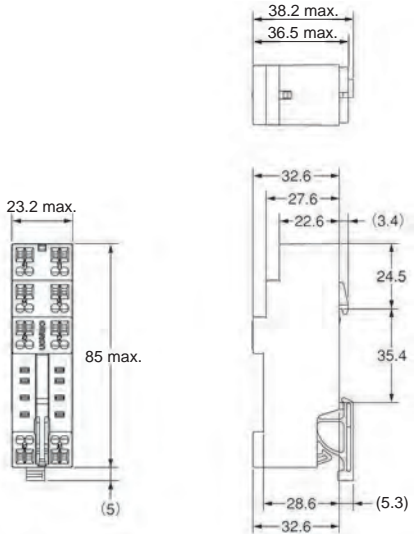
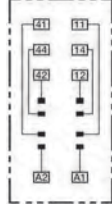

(Unit: mm)

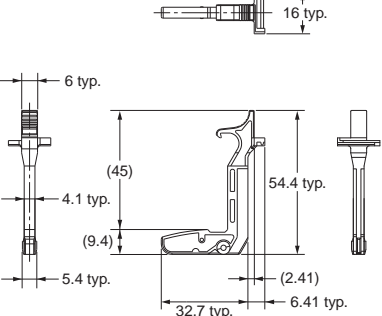
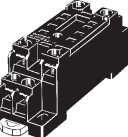
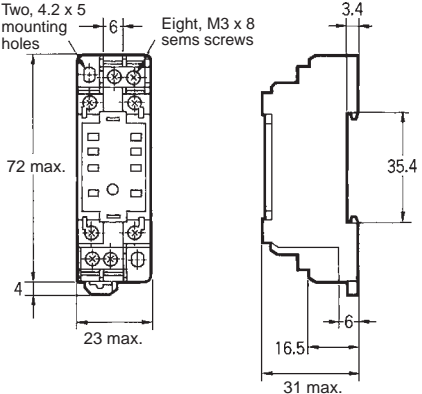
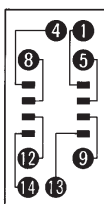
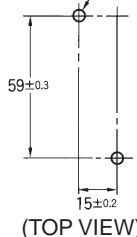
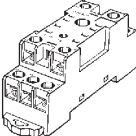
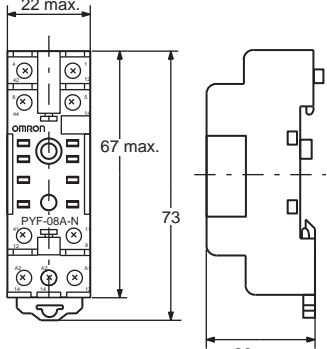
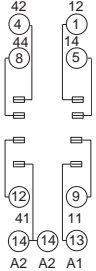
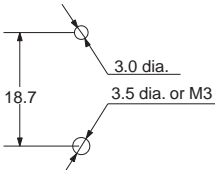

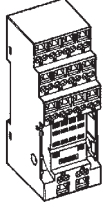
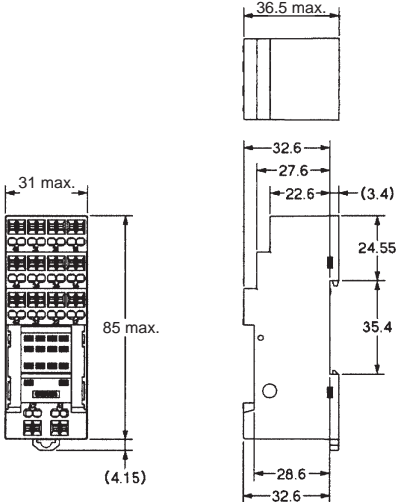
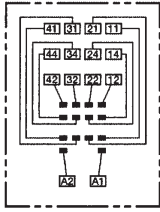
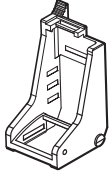
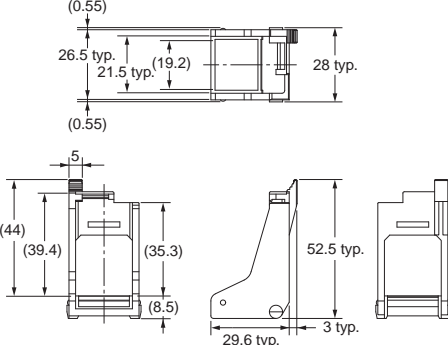
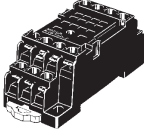
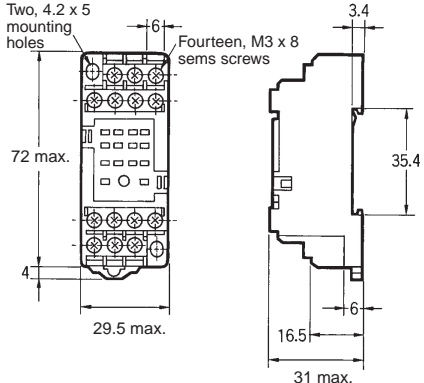
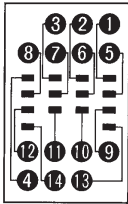
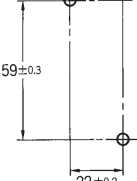
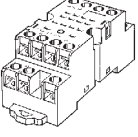
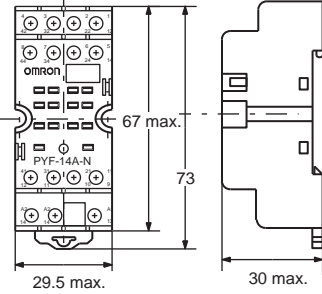
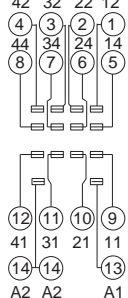
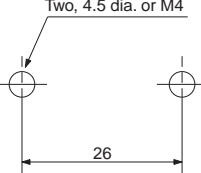

Note: All units are in millimeters unless otherwise indicated.

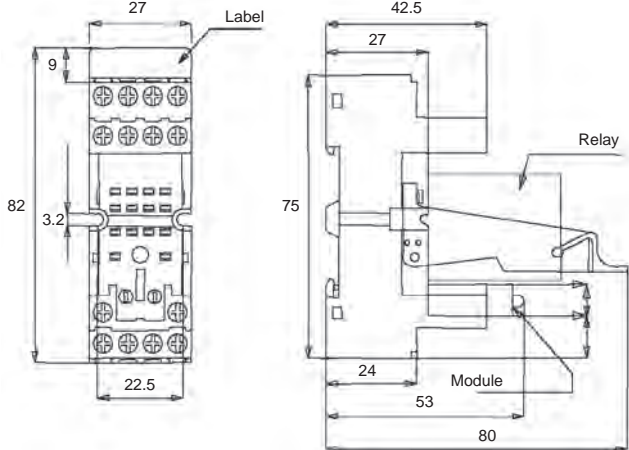
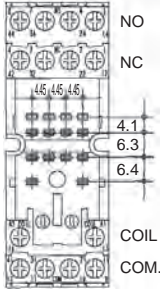
Socket	Dimensions	Terminal arrangement/ Internal connections (top view)	Mounting holes
<p>PYF08S</p> 			<p>---</p>
<p>PYCM-08S for PYF08S</p> 		<p>---</p>	<p>---</p>
<p>PYF08A-E</p> 			<p>Two, M3, M4, or 4.5-dia. holes</p>  <p><b>Note:</b> DIN-rail mounting is also possible. Refer to page 34 for supporting DIN-rails.</p>
<p>PYF08A-N</p> 			 <p><b>Note:</b> DIN-rail mounting is also possible. Refer to page 34 for supporting DIN-rails.</p>

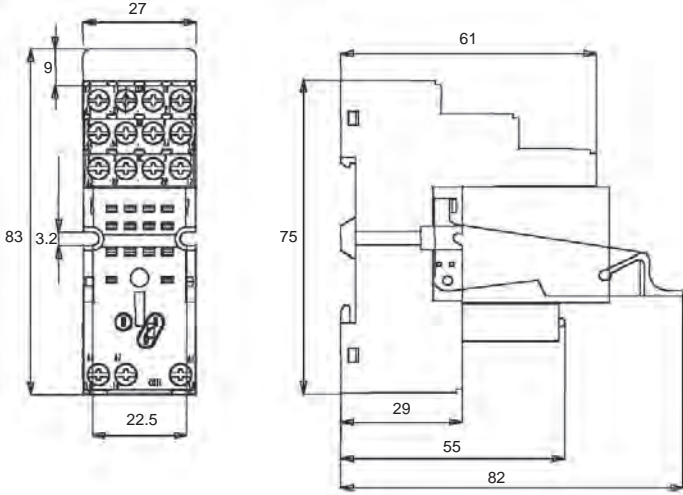
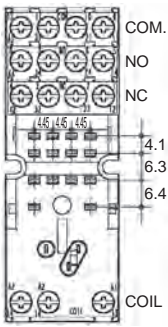
Socket	Dimensions	Terminal arrangement/ Internal connections (top view)	Mounting holes
<p>PYF14S</p> 			<p>---</p>
<p>PYCM-14S for PYF14S</p> 		<p>---</p>	<p>---</p>
<p>PYF14A-E</p> 			<p>Two, M3, M4, or 4.5-dia. holes</p>  <p>(TOP VIEW)</p> <p><b>Note:</b> DIN-rail mounting is also possible. Refer to page 34 for supporting DIN-rails.</p>
<p>PYF14A-N</p> 			<p>Two, 4.5 dia. or M4</p>  <p><b>Note:</b> DIN-rail mounting is also possible. Refer to page 34 for supporting DIN-rails.</p>

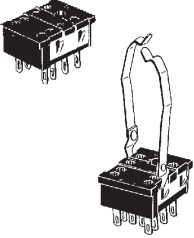
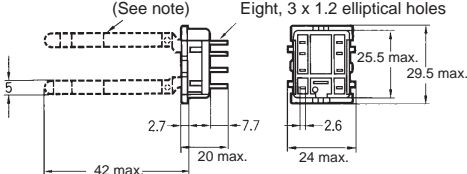
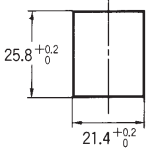
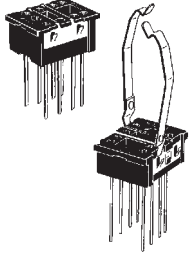
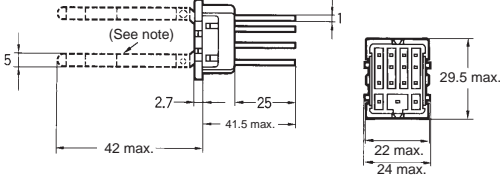
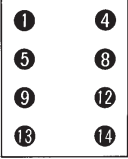
# MY(S)

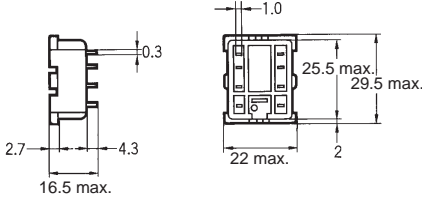
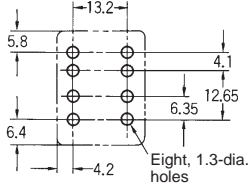
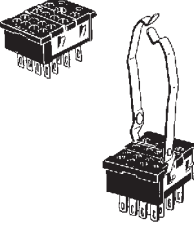
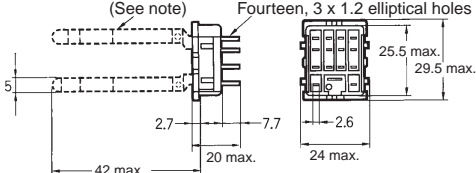
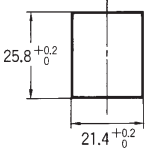
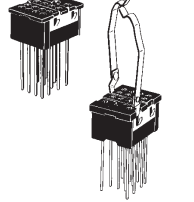
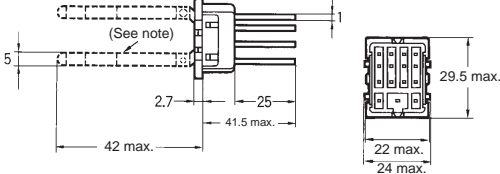
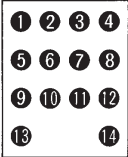

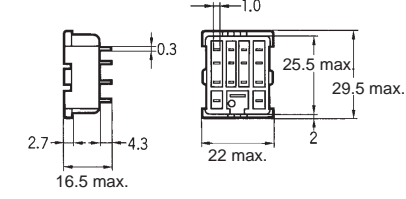
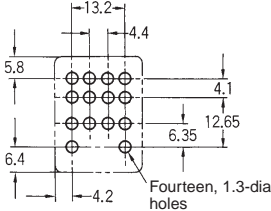
Socket	Dimensions	Terminal arrangement/ Internal connections (top view)/ mounting holes
<p>PYF14-ESN</p> 		
<p>PYF14-ESS</p> 		

Socket	Dimensions	Terminal arrangement/ Internal connections (top view)	Mounting holes
<p>PY08/PY08-Y1</p> 	 <p>(See note) Eight, 3 x 1.2 elliptical holes</p> <p>25.5 max. 29.5 max.</p> <p>42 max. 20 max. 24 max.</p> <p>2.7 7.7 2.6</p> <p><b>Note:</b> The PY08-Y1 includes sections indicated by dotted lines.</p>		 <p>25.8<sup>+0.2</sup><sub>0</sub> 21.4<sup>+0.2</sup><sub>0</sub></p>
<p>PY08QN/ PY08QN-Y1</p> 	 <p>(See note)</p> <p>25.5 max. 29.5 max.</p> <p>42 max. 41.5 max. 22 max. 24 max.</p> <p>2.7 25</p> <p><b>Note:</b> The PY14QN-Y1 includes sections indicated by dotted lines.</p>	 <p>1 4 5 8 9 12 13 14</p>	
<p>PY08-02</p> 	 <p>0.3 1.0 25.5 max. 29.5 max.</p> <p>2.7 4.3 22 max. 2</p> <p>16.5 max.</p>		 <p>13.2 5.8 4.1 12.65 6.35 6.4 4.2</p> <p>Eight, 1.3-dia. holes</p>
<p>PY14/PY14-Y1</p> 	 <p>(See note) Fourteen, 3 x 1.2 elliptical holes</p> <p>25.5 max. 29.5 max.</p> <p>42 max. 20 max. 24 max.</p> <p>2.7 7.7 2.6</p> <p><b>Note:</b> The PY14-Y1 includes sections indicated by dotted lines.</p>		 <p>25.8<sup>+0.2</sup><sub>0</sub> 21.4<sup>+0.2</sup><sub>0</sub></p>
<p>PY14QN/ PY14QN-Y1</p> 	 <p>(See note)</p> <p>25.5 max. 29.5 max.</p> <p>42 max. 41.5 max. 22 max. 24 max.</p> <p>2.7 25</p> <p><b>Note:</b> The PY14QN-Y1 includes sections indicated by dotted lines.</p>	 <p>1 2 3 4 5 6 7 8 9 10 11 12 13 14</p>	
<p>PY14-02</p> 	 <p>0.3 1.0 25.5 max. 29.5 max.</p> <p>2.7 4.3 22 max. 2</p> <p>16.5 max.</p>		 <p>13.2 4.4 5.8 4.1 12.65 6.35 6.4 4.2</p> <p>Fourteen, 1.3-dia. holes</p>

**Note:** Use a panel with plate thickness of 1 to 2 mm for mounting the Sockets.

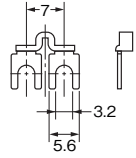

## Short Bars for Relay Sockets and PYF Sockets

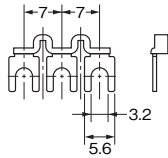
### Short Bars for within the Same Socket

Pitch	Applicable model	Appearance	Dimensions (mm)	Model	Specifications
7 mm	PYF14A			PYD-020B□ (2P)	Max. carry current: 20 A (18 A at 70°C) Ambient operating temp.: -40 to 70°C (with no icing or condensation) Ambient operating humidity: 45% to 85% (with no icing or condensation) Conductor material: Brass Conductor surface treatment: Nickel plating Qty per package: 50/bag
				PYD-030B□ (3P)	

Note: Replace the box (□) in the model number with the specification code for the covering color. B: Black, Y: Yellow

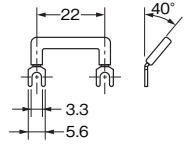
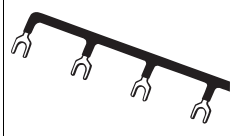
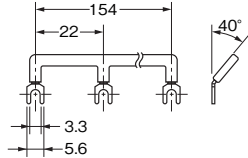
### Short Bars for Adjacent Sockets

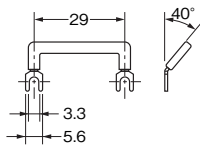
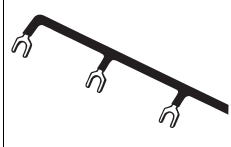
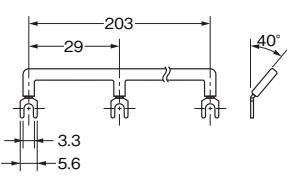
Pitch	Applicable model	Appearance	Dimensions (mm)	Model	Specifications
22 mm	PYF08A			PYD-025B□ (2P)	Max. carry current: 20 A (18 A at 70°C) Ambient operating temp.: -40 to 70°C (with no icing or condensation) Ambient operating humidity: 45% to 85% (with no icing or condensation) Conductor material: Brass Conductor surface treatment: Nickel plating Qty per package: 10/bag
				PYD-085B□ (8P)	
29 mm	PYF14A			PYD-026B□ (2P)	Max. carry current: 20 A (18 A at 70°C) Ambient operating temp.: -40 to 70°C (with no icing or condensation) Ambient operating humidity: 45% to 85% (with no icing or condensation) Conductor material: Brass Conductor surface treatment: Nickel plating Qty per package: 10/bag
				PYD-086B□ (8P)	

Note: Replace the box (□) in the model number with the specification code for the covering color. B: Black, S: Blue, R: Red

### Short Bars

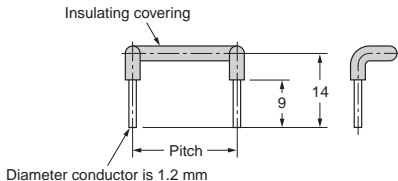
Pitch	Applicable model	Appearance and dimensions (mm)	Model	Covering color
19.7 mm	PYF08S		PYDM-08SR	Red
			PYDM-08SB	Blue
27.5 mm	PYF14S		PYDM-14SR	Red
			PYDM-14SB	Blue

Note: Use these Short Bars for crossover wiring of relay coils.

## Safety Precautions

### Maximum Carry Current

- Do not allow the total current for all shorted poles to exceed the maximum carry current of the Short Bar.
- Do not exceed the maximum carry current of the relay contacts for individual poles.
- If you use more than one Socket, use End Plates (PFP-M).



**Hold-down Clips**

**PYC-A1**  
(2 pcs per set)

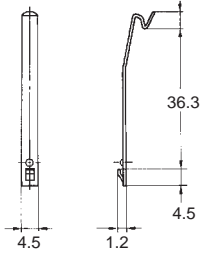

**PYC-E1**  
(2 pcs per set)

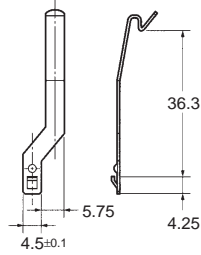

**For sockets PYF14-ESN/-ESS**

Model	Description
PYC-0	Metal spring clip (Used with Relay only)
PYC 35	Plastic holding clip (Used with Relay only)
PYC TR1	Thermoplastic writable label

**Note:** For total dimensions with plastic clip please refer to drawings of the sockets.

**PYC-P**

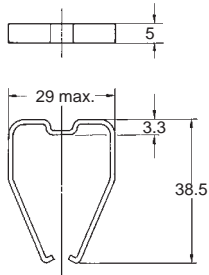

**PYC-P2**

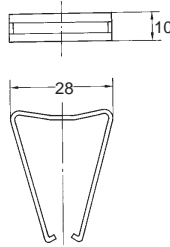

**Mounting Plates for Back-connecting Sockets**

**PYP-1**

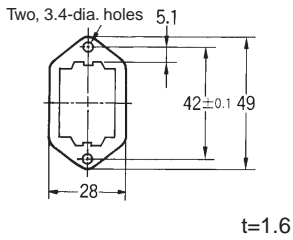

**PYP-36**

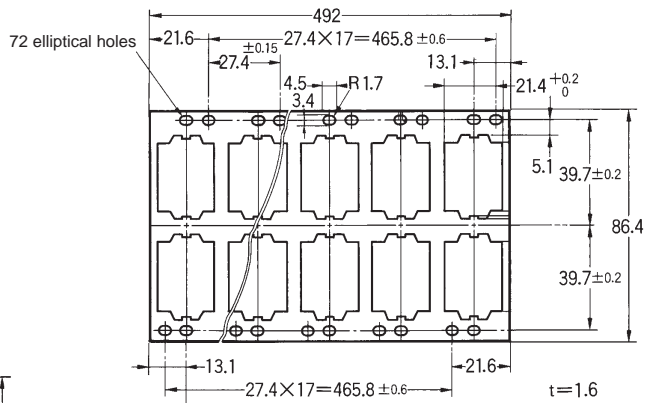

**PYP-18**

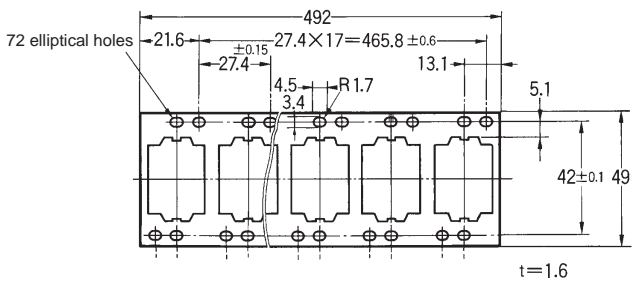

## DIN-rails and Accessories

### Supporting DIN-rails

#### PFP-50N/PFP-100N

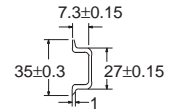
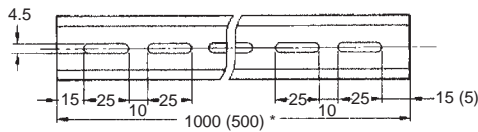
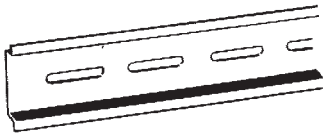

Note: The figure in the parentheses is for PFP-50N.

#### PFP-100N2

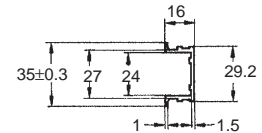
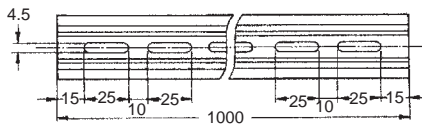
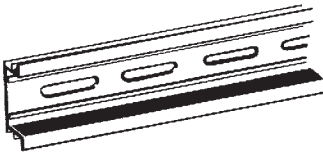

#### End Plate

##### PFP-M

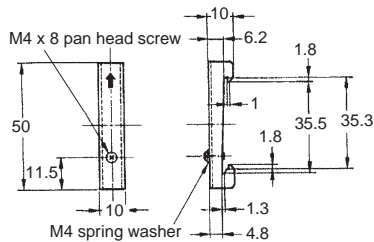

#### Spacer

##### PFP-S

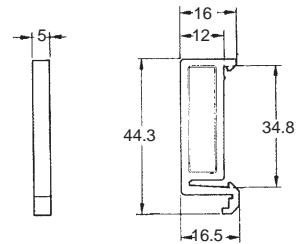
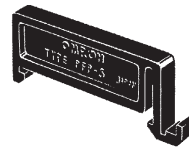

## Safety Precautions

Refer to the *Common Relay Precautions*.

### Precautions for Correct Use

#### Handling

For models with a built-in operation indicator, models with a built-in diode, or high-sensitivity models, check the coil polarity when wiring and wire all connections correctly (DC operation).

#### Installation

- There is no specifically required installation orientation, but make sure that the Relays are installed so that the contacts are not subjected to vibration or shock in their movement direction.

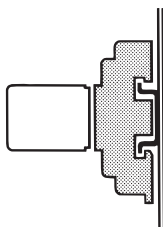

- Use two M3 screws to attach case-surface-mounted models (MY□F) and tighten the screws securely (tightening torque: 0.98 N•m).

#### Using MY-series Relays with Microloads with Infrequent Operation

If any standard MY-series Relays (e.g., MY4) are used infrequently to switch microloads, the contacts may become unstable and eventually result in poor contact. In this case, we recommend using the MY4Z-CBG Series, which has high contact reliability for microloads (Refer to page 15.)

#### About the Built-in Diode and CR Elements

The diode or CR element that are built into the Relay are designed to absorb the reverse voltage from the Relay coil. If a large surge in voltage is applied to the diode or CR element from an external source, the element will be destroyed. If there is the possibility of large voltage surges that could be applied to the elements from an external source, take any necessary surge absorption measures.

#### Latching Levers

- Turn OFF the power supply when operating the latching lever. After you use the latching lever always return it to its original state.
- Do not use the latching lever as a switch.
- The latching lever can be used for 100 operations min.

#### Relay Replacement

To replace the Relay, turn OFF the power supply to the load and Relay coil sides to prevent unintended operation and possible electrical shock.

# Terms and Conditions Agreement

## **Read and understand this catalog.**

Please read and understand this catalog before purchasing the products. Please consult your OMRON representative if you have any questions or comments.

## **Warranties.**

- (a) Exclusive Warranty. Omron's exclusive warranty is that the Products will be free from defects in materials and workmanship for a period of twelve months from the date of sale by Omron (or such other period expressed in writing by Omron). Omron disclaims all other warranties, express or implied.
- (b) Limitations. OMRON MAKES NO WARRANTY OR REPRESENTATION, EXPRESS OR IMPLIED, ABOUT NON-INFRINGEMENT, MERCHANTABILITY OR FITNESS FOR A PARTICULAR PURPOSE OF THE PRODUCTS. BUYER ACKNOWLEDGES THAT IT ALONE HAS DETERMINED THAT THE PRODUCTS WILL SUITABLY MEET THE REQUIREMENTS OF THEIR INTENDED USE.

Omron further disclaims all warranties and responsibility of any type for claims or expenses based on infringement by the Products or otherwise of any intellectual property right. (c) Buyer Remedy. Omron's sole obligation hereunder shall be, at Omron's election, to (i) replace (in the form originally shipped with Buyer responsible for labor charges for removal or replacement thereof) the non-complying Product, (ii) repair the non-complying Product, or (iii) repay or credit Buyer an amount equal to the purchase price of the non-complying Product; provided that in no event shall Omron be responsible for warranty, repair, indemnity or any other claims or expenses regarding the Products unless Omron's analysis confirms that the Products were properly handled, stored, installed and maintained and not subject to contamination, abuse, misuse or inappropriate modification. Return of any Products by Buyer must be approved in writing by Omron before shipment. Omron Companies shall not be liable for the suitability or unsuitability or the results from the use of Products in combination with any electrical or electronic components, circuits, system assemblies or any other materials or substances or environments. Any advice, recommendations or information given orally or in writing, are not to be construed as an amendment or addition to the above warranty.

See <http://www.omron.com/global/> or contact your Omron representative for published information.

## **Limitation on Liability; Etc.**

OMRON COMPANIES SHALL NOT BE LIABLE FOR SPECIAL, INDIRECT, INCIDENTAL, OR CONSEQUENTIAL DAMAGES, LOSS OF PROFITS OR PRODUCTION OR COMMERCIAL LOSS IN ANY WAY CONNECTED WITH THE PRODUCTS, WHETHER SUCH CLAIM IS BASED IN CONTRACT, WARRANTY, NEGLIGENCE OR STRICT LIABILITY.

Further, in no event shall liability of Omron Companies exceed the individual price of the Product on which liability is asserted.

## **Suitability of Use.**

Omron Companies shall not be responsible for conformity with any standards, codes or regulations which apply to the combination of the Product in the Buyer's application or use of the Product. At Buyer's request, Omron will provide applicable third party certification documents identifying ratings and limitations of use which apply to the Product. This information by itself is not sufficient for a complete determination of the suitability of the Product in combination with the end product, machine, system, or other application or use. Buyer shall be solely responsible for determining appropriateness of the particular Product with respect to Buyer's application, product or system. Buyer shall take application responsibility in all cases.

NEVER USE THE PRODUCT FOR AN APPLICATION INVOLVING SERIOUS RISK TO LIFE OR PROPERTY OR IN LARGE QUANTITIES WITHOUT ENSURING THAT THE SYSTEM AS A WHOLE HAS BEEN DESIGNED TO ADDRESS THE RISKS, AND THAT THE OMRON PRODUCT(S) IS PROPERLY RATED AND INSTALLED FOR THE INTENDED USE WITHIN THE OVERALL EQUIPMENT OR SYSTEM.

## **Programmable Products.**

Omron Companies shall not be responsible for the user's programming of a programmable Product, or any consequence thereof.

## **Performance Data.**

Data presented in Omron Company websites, catalogs and other materials is provided as a guide for the user in determining suitability and does not constitute a warranty. It may represent the result of Omron's test conditions, and the user must correlate it to actual application requirements. Actual performance is subject to the Omron's Warranty and Limitations of Liability.

## **Change in Specifications.**

Product specifications and accessories may be changed at any time based on improvements and other reasons. It is our practice to change part numbers when published ratings or features are changed, or when significant construction changes are made. However, some specifications of the Product may be changed without any notice. When in doubt, special part numbers may be assigned to fix or establish key specifications for your application. Please consult with your Omron's representative at any time to confirm actual specifications of purchased Product.

## **Errors and Omissions.**

Information presented by Omron Companies has been checked and is believed to be accurate; however, no responsibility is assumed for clerical, typographical or proofreading errors or omissions.

**OMRON Corporation** Industrial Automation Company  
Tokyo, JAPAN

Contact: [www.ia.omron.com](http://www.ia.omron.com)

**Regional Headquarters**

**OMRON EUROPE B.V.**

Wegalaan 67-69, 2132 JD Hoofddorp  
The Netherlands  
Tel: (31)2356-81-300/Fax: (31)2356-81-388

**OMRON ELECTRONICS LLC**

2895 Greenspoint Parkway, Suite 200  
Hoffman Estates, IL 60169 U.S.A  
Tel: (1) 847-843-7900/Fax: (1) 847-843-7787

**OMRON ASIA PACIFIC PTE. LTD.**

No. 438A Alexandra Road # 05-05/08 (Lobby 2),  
Alexandra Technopark,  
Singapore 119967  
Tel: (65) 6835-3011/Fax: (65) 6835-2711

**OMRON (CHINA) CO., LTD.**

Room 2211, Bank of China Tower,  
200 Yin Cheng Zhong Road,  
PuDong New Area, Shanghai, 200120, China  
Tel: (86) 21-5037-2222/Fax: (86) 21-5037-2200

**Authorized Distributor:**

© OMRON Corporation 2015 All Rights Reserved.  
In the interest of product improvement,  
specifications are subject to change without notice.

**Cat. No. J199-E1-01**

Printed in Japan  
0115 (0115)