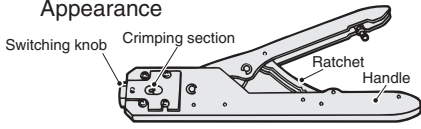

Accessories (Order Separately)

Ordering Information

Connectors and Connector Hold-down Clips

Applicable Sensor models EE-SX67□(A, P, R), EE-SX47□, EE-SY67□, EE-SPY31□/41□, EE-SPX303/403, EE-SPW311/411					
Type	Cable length	Model	Remarks		
Connector		EE-1001			
		EE-1001-1	L terminal and positive (+) terminal are already short-circuited.		
		EE-1009 *1			
		Connector with Cable	1 m	EE-1006	
				EE-1010 *1	
			2 m	EE-1006	4 conductors
				EE-1006D	3 conductors
		EE-1006L		2 conductors	
		Connector with Robot Cable	1 m	EE-1010-R *1	
			2 m	EE-1010-R *1	
NPN/PNP Conversion Connector	0.46 m (total length)	EE-2002			
Connector Hold-down Clip		EE-1006A	For EE-1006, EE-SX670□, 470, EE-SY671, and 672 only.		
Connector Parts *2	Case (housing)	EE-1006H	100 per carton		
	Dispersion Pins	EE-1006C	500 per carton		
	Special Crimping Tool	EE-1006T	Appearance 		

* 1. EE-1009- or EE-1010-series Connectors have a built-in locking mechanism to prevent cable disconnection when only the cable is pulled. To remove the Connector from the Sensor, grip the top and bottom of the Connector firmly and push into the Sensor once before pulling out. The locking mechanism prevents the Connector from being removed by pulling on the cable only and enables removal only when the Connector (housing) is pulled.

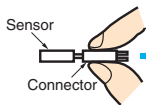





* 2. The case (housing) and dispersion pins (for hand-crimping) for EE-1006 Connectors can be purchased separately. Use the EE-1006T Special Crimping Tool to prepare the Connector.

Applicable Sensor models EE-SPX301/401, EE-SPY30□/40□, EE-SPZ301□/401□			
Item	Cable length	Model	Remarks
Connector		EE-1002	
		Connector with Cable	1 m
NPN/PNP Conversion Connector	0.46 m (total length)	EE-2001	
Connector Hold-down Clip		EE-1003A	For EE-1003 only.

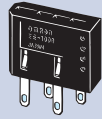
Applicable Sensor models EE-SPX74□/84□			
Item	Cable length	Model	Remarks
Connector with Cable	1 m	EE-1013	

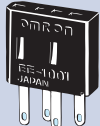
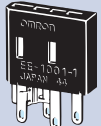

Ratings/Characteristics

Product	Connector *1	Connector with Cable *1	Connector with Robot Cable *1	Connector	Connector (short-circuited between positive (+) and L terminals) *2	Connector with Cable	
	Model	EE-1009	EE-1010	EE-1010-R	EE-1001	EE-1001-1	EE-1006
Item	Appearance						
Contact resistance		20 mΩ max. (at 20 mV max., 100 mA max.)			15 mΩ max. (at 100 VDC max.)		10 mΩ max. (100 VDC max.)
Insertion/removal durability		50 times min.			---		
Insertion strength		No. of poles × 6 N max.			50 N max.		
Surplus strength (housing holding strength)		No. of poles × 0.4 N max.			---		20 N max.
Standard cable length		---	2 m		---	2 m	
Lock strength		No. of poles × 29 N min.			---		
Ambient humidity		-10 to +60°C			-10 to +75°C		-10 to +60°C
Material	Housing	Polybutylene phthalate (PBT)					
	Contact	Phosphor bronze (solder plating)					
Applicable Photomicrosensors		EE-SX67□ (A,P,R), EE-SX47□, EE-SY67□, EE-SPY31□/41□, EE-SPX303/403, EE-SPW311/411					

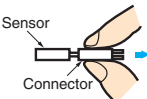
* 1. The Connector has a built-in locking mechanism. To remove the Connector from the Sensor, grip the top and bottom of the Connector housing, as shown in the following diagram, and then pull out the Connector.

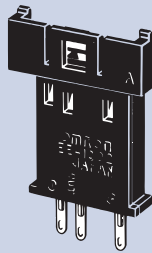

* 2. EE-SX67□ and EE-SY67□ are the best used in the light-ON state.

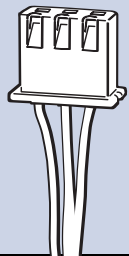
Product	Connector	Connector with Cable	Connector with Cable	
	Model	EE-1002	EE-1003	EE-1013
Item	Appearance			
Contact resistance		10 mΩ max. (at 10 mADC and 1 ADC)	20 mΩ max. (at minute current of 1 kHz and 500 VDC)	
Insertion strength		20 N max.	23.5 N max.	40 N max.
Surplus strength (housing holding strength)		15 N max. (initial) 10 N max. (ten times)	3.5 N max.	10 N max.
Cable length		---	1 m	
Ambient humidity		-10 to +75°C	-10 to +60°C	-10 to 55°C
Material	Housing	Nylon		
	Contact	Phosphor bronze (solder plating)		
Applicable Photomicrosensors		EE-SPX301/401, EE-SPY30□/40□, EE-SPZ301□/401□		EE-SPX74□/84□

Dimensions (Unit: mm)

Photomicrosensor Connectors and Connector Hold-down Clips

Connector

EE-1001

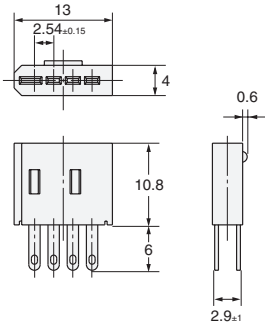
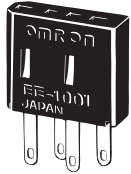

Connector (short-circuited between positive (+) and L terminals)

EE-1001-1

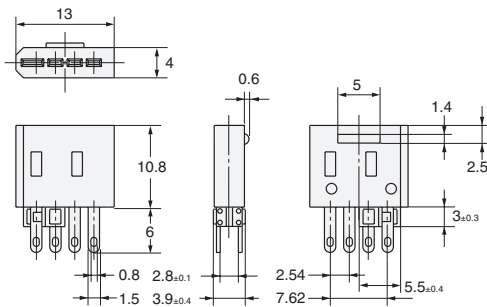
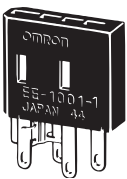

Connector with Cable

EE-1006

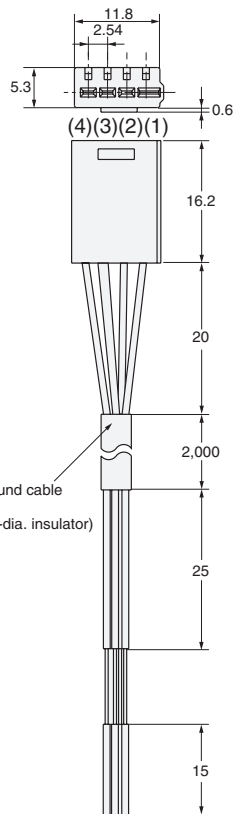
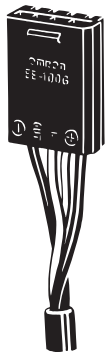

Cable:
Vinyl-insulated round cable
of 4 dia., 4 cores,
(0.2 mm² with 1.1-dia. insulator)

Terminal Arrangement

(1)	⊕	Brown
(2)	L	Pink
(3)	OUT	Black
(4)	⊖	Blue

Connector Hold-down Clip

EE-1006A

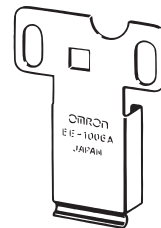

(Can be used only with EE-1006 Connectors for the Photomicrosensors listed below.)

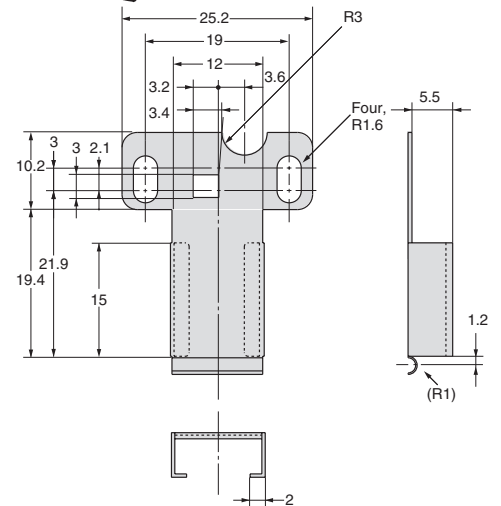

Material: Stainless steel

Applicable Photomicrosensors	EE-SX67□(A,P,R), EE-SX47□, EE-SY67□, EE-SPY31□/41□, EE-SPX303/403, EE-SPW311/411
------------------------------	--

For EE-1006, EE-SX670□, 470, EE-SY671, and 672 only.

Photomicrosensor Connectors

Connectors

EE-1009

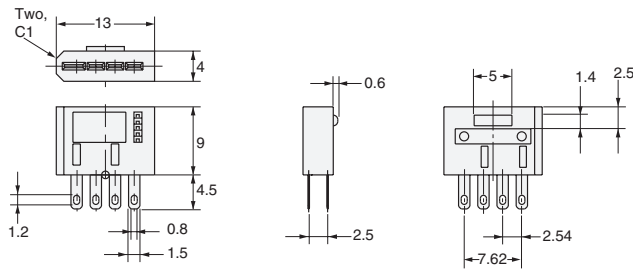

Connector with Cable

EE-1010

Connector with Robot Cable

EE-1010-R

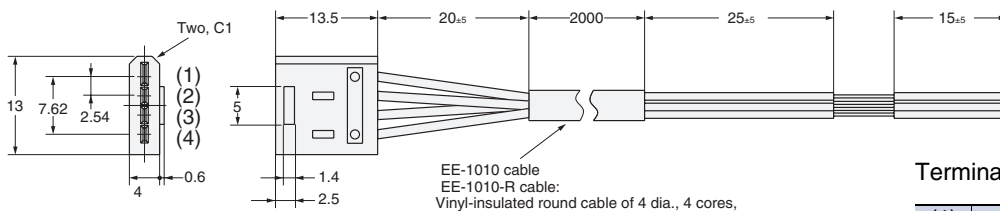

EE-1010 cable
 EE-1010-R cable:
 Vinyl-insulated round cable of 4 dia., 4 cores,
 (0.2 mm² with 1.1-dia. insulator)

Terminal Arrangement

(1)	⊕	Brown
(2)	L	Pink
(3)	OUT	Black
(4)	⊖	Blue

Applicable Photomicrosensors	EE-SX67□(A,P,R), EE-SX47□, EE-SY67□, EE-SPY31□/41□
	EE-SPX303/403, EE-SPW311/411

NPN to PNP Transistor Output Conversion Connectors

NPN/PNP Conversion Connector

EE-2001

Terminal Arrangement

(1)	⊕	Brown
(2)	OUT	Black
(3)	⊖	Blue

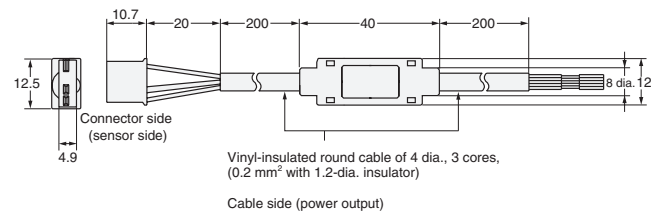
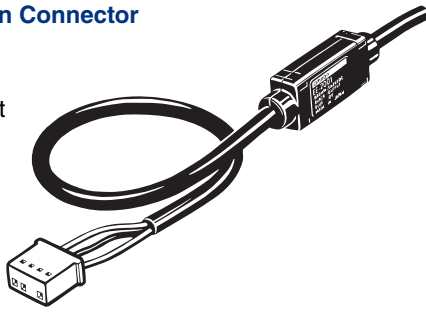

NPN/PNP Conversion Connector

EE-2002 *

Terminal Arrangement

(1)	⊕	Brown
(2)	OUT	Black
(3)	⊖	Blue

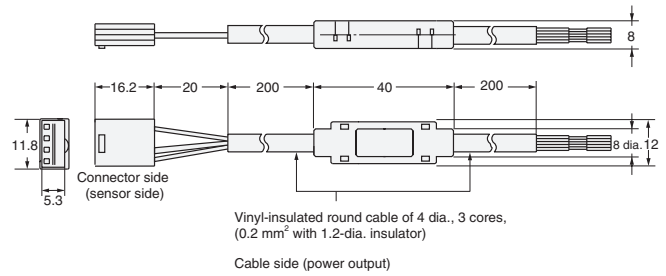
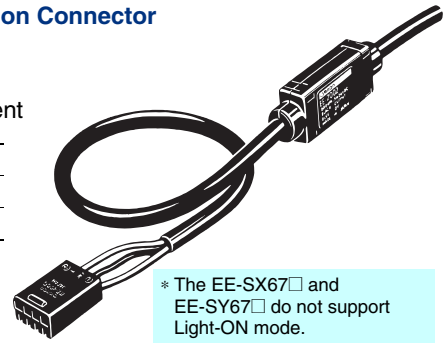

Applicable Photomicrosensors	EE-SPX301/401, EE-SPY30□/40□, EE-SPZ301□/401□	EE-SX67□(A,P,R), EE-SX47□, EE-SY67□, EE-SPY31□/41□, EE-SPX303/403, EE-SPW311/411
------------------------------	---	--