

E3T

Additions to the Series

Small but Sharp Slimmest BGS* Reflective Sensors in the Market

- Series now includes BGS reflective model with black/white error of 15%
- Easy optical axis adjustment with emitter axis accuracy of $\pm 2^\circ$ (Through-beam Model)
- Noise and external light resistance enhanced to that of E3Z or equivalent
- Complete Compliance with RoHS
- The Series includes models with M12 Smartclick pre-wired connectors (-M1TJ) 

* BGS (Background Suppression) technology prevents detecting background objects.

 Be sure to read *Safety Precautions* on page 13.



Features

The Slimmest BGS (Background Suppression) Reflective Photoelectric Sensors in the World

Ultra slim at 3.5 mm and black/white error of only 15%.
For example, the E3T-FL1□ can stably detect a black object at 12 mm without being affected by a white background at 20 mm.
OMRON provides BGS performance sharper than the previous Convergent-reflective Sensors.

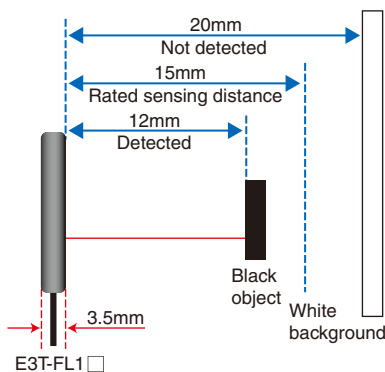

Dramatic Improvement in Black/White Error

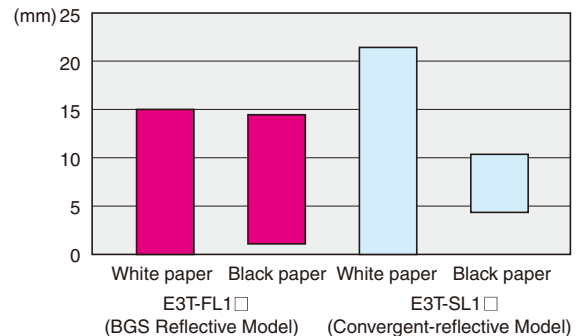

State-of-the-Art Technology Achieved Ultra Thin BGS

First Mounted Flip Chip in Industry Patent Pending

This shape and slimmess make a massive contribution to resolving issues, such as sensor space constraints.

Flip-chip mounting technology, the ultimate in miniature mounting technology for attaching IC chips without covering them in resin, is what makes the slim structure of the E3T-FL possible.
The E3T-FL is just 3.5 mm wide, even with a two-part light receiving element on the surface of the circuit board and a signal processing IC on the rear.

Flip-chip mounting of the IC has enabled the mounting volume to be kept to the absolute minimum.

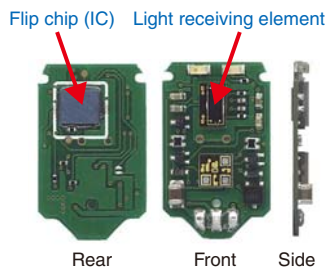

High-precision Alignment Technology Patent Pending

High-precision alignment technology is greatly contributing to reducing installation and adjustment work onsite.

The E3T-FL sensing distances are subtly controlled using high-precision alignment technology, which aligns the optical axes of more than one part.

The light receiving lens with its unique thin-walled structure is automatically adjusted inline to keep sensing distance fluctuations to a minimum.

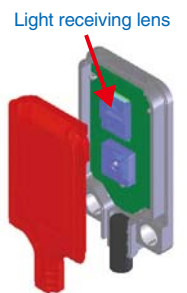

Upgraded Products

E3T-ST Through-beam (Side View) Models/ E3T-FT Through-beam (Flat) Models

Long-distance detection Side-view Models: 1 m, Flat Models: 500mm
300-mm Models are also available to prevent mutual interference.
Minimum detection object: 0.5 mm dia. (with slit attached)
Optical axis accuracy of $\pm 2^\circ$ for installation reliability.
Easily distinguish between color-coded Emitter and Receiver lenses.



E3T-SL Convergent-reflective Models (Side-view)

Minimum detection object: 0.15 mm dia.
Resistant to background and surrounding metal

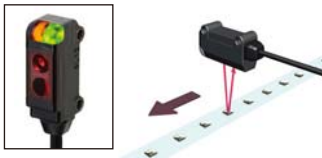

E3T-SR Retro-reflective Models (Side-view) * Twin-lens Optical System

Two models for different reflector characteristics.
E3T-SR2□: With E39-R4, Sensing distance: 200 mm
E3T-SR3□: With E39-R37, Sensing distance: 100 mm

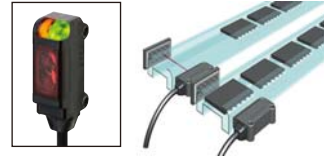

E3T-FD Diffuse-reflective Models (Flat)

Minimum detection object: 0.15 mm dia.
Only 3.5 mm wide for installation in small gaps.



Reliability to the Performance Improved by Product Upgrades

Installation Reliability

Great Reductions in Time Required for Adjusting Through-beam Sensor Optical Axes

Even at this size the Emitter axis accuracy is $\pm 2^\circ$. High-precision alignment technology has enabled maximum reduction of light axis fluctuations of the Emitter beam. The margin for the received light is doubled if the Emitter and Receiver mechanical axes are aligned (at the rated sensing distance).

Operating Reliability

Improved Detection Stability for Reflective Sensors

Uses the well-praised disturbance light bypass algorithm from the E3Z Series. Environmental resistance to inverter fluorescent lights and other light interference has been greatly improved.

Wiring Reliability

Sensor Protection Against Wiring Mistakes

New output reverse polarity protection function added. (A reverse polarity protection diode has been added to the output line.)

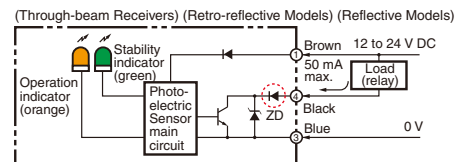

Models with NPN Output

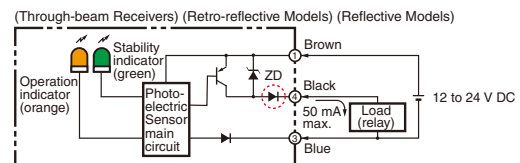

Models with PNP Output

Complete Compliance with RoHS

Lead, mercury, cadmium hexachrome, polybrominated biphenyl (PBB), and polybrominated diphenyl ether (PBDE) have all been removed. And burnable polyethylene packaging has been used.



Ordering Information

Sensors

 Red light

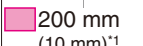
Sensing method	Appearance		Connection method	Sensing distance	Operation mode	Model	
						NPN output	PNP output
Through-beam	 Side-view	 Flat	Pre-wired	1 m 	Light-ON	E3T-ST11 ^{*2,3}	E3T-ST13
				(Sensitivity Adjustment Unit can be used.)	Dark-ON	E3T-ST12 ^{*2,3}	E3T-ST14
	300 mm 	Light-ON		E3T-ST21 ^{*3}	E3T-ST23		
	Dark-ON	E3T-ST22 ^{*3}		E3T-ST24			
	500 mm 	Light-ON		E3T-FT11 ^{*2,3}	E3T-FT13		
	Dark-ON	E3T-FT12 ^{*2,3}		E3T-FT14			
Retro-reflective	 Side-view	 Flat	For E39-R4 only 200 mm (10 mm) ^{*1} 	Light-ON	E3T-SR21 ^{*2,3}	E3T-SR23	
			Dark-ON	E3T-SR22 ^{*2,3}	E3T-SR24		
	 Side-view	 Flat	For E39-R37 only 100 mm (10 mm) ^{*1} 	Light-ON	E3T-SR31 ^{*2,3}	E3T-SR33	
			Dark-ON	E3T-SR32 ^{*2,3}	E3T-SR34		
Diffuse-reflective	 Side-view	 Flat	5 to 30 mm 	Light-ON	E3T-FD11 ^{*2,3}	E3T-FD13	
				Dark-ON	E3T-FD12 ^{*2,3}	E3T-FD14	
Convergent-reflective	 Side-view	 Flat	5 to 15 mm 	Light-ON	E3T-SL11 ^{*2,3}	E3T-SL13	
				Dark-ON	E3T-SL12 ^{*2,3}	E3T-SL14	
				5 to 30 mm 	Light-ON	E3T-SL21 ^{*2,3}	E3T-SL23
					Dark-ON	E3T-SL22 ^{*2,3}	E3T-SL24
BGS reflective	 Side-view	 Flat	1 to 15 mm 	Light-ON	E3T-FL11 ^{*2,3}	E3T-FL13	
				Dark-ON	E3T-FL12 ^{*2,3}	E3T-FL14	
				1 to 30 mm 	Light-ON	E3T-FL21 ^{*2,3}	E3T-FL23
					Dark-ON	E3T-FL22 ^{*2,3}	E3T-FL24

Note: Models with M12 Smartclick pre-wired connectors are also available for all models in the table. The cable is 0.3 m long.

When ordering, add "-M1J" to the end of the model number (e.g., E3T-ST11-M1TJ 0.3M)

*1. Values in parentheses indicate the minimum required distance between the Sensor and Reflector.

*2. A Robotics Cable is provided for models in the table marked with ². These models have an R suffix. (Example: E3T-ST11R)

*3. An e-CON Pre-wired Connector with a 0.3 m or 2 m cable is provided for models in the table marked with ³. These models have an -ECON suffix. (Example: E3T-ST11-ECON 2M). The connector is the E-39-ECON□M with a 2-m or 5-m cable and a connector on one end or the E39-ECONW□M with a 0.5-m to 2-m cable (length increases in 0.1-m increments) and connectors at both ends. The length of the cable is marked on the box. (Example: E39-ECON2M) This e-CON specification is rapidly becoming the standard for FA equipment and connector manufacturers.

Accessories (Order Separately)

Slits

Slit width	Sensing distance (typical) (Sensor model)	Minimum detectable object (typical)	Model	Quantity	Remarks		
0.5-mm dia.	100 mm (E3T-ST1□)	0.5-mm dia.	E39-S63	One each for Emitter and Receiver; common with Slit widths of 1 dia. and 0.5 dia. (total of 2)	Plug-in type round slits Can be used with E3T-ST□□ Through-beam Models.		
	30 mm (E3T-ST2□)						
1-mm dia.	300 mm (E3T-ST1□)	1-mm dia.	E39-S63		One each for Emitter and Receiver; common with Slit widths of 1 dia. and 0.5 dia. (total of 2)	Plug-in type round slits Can be used with E3T-ST□□ Through-beam Models.	
	100 mm (E3T-ST2□)						
0.5-mm dia.	50 mm (E3T-FT1□)	0.5-mm dia.	E39-S64			One each for Emitter and Receiver; common with Slit widths of 1 dia. and 0.5 dia. (total of 2)	Plug-in type round slits Can be used with E3T-FT□□ Through-beam Models.
	30 mm (E3T-FT2□)						
1-mm dia.	100 mm (E3T-FT1□)	1-mm dia.	E39-S64	One each for Emitter and Receiver; common with Slit widths of 1 dia. and 0.5 dia. (total of 2)			Plug-in type round slits Can be used with E3T-FT□□ Through-beam Models.
	50 mm (E3T-FT2□)						

Reflectors





Name	Sensing distance (Sensor model)	Minimum detectable object (typical)	Model	Quantity	Remarks
Small Reflectors	200 mm (10 mm) * (E3T-SR2□)	2 mm dia.	E39-R4	1	Provided with the E3T-SR2□ Retro-reflective Models.
	100 mm (10 mm) * (E3T-SR3□)		E39-R37		Provided with the E3T-SR3□ Retro-reflective Models.

* Values in parentheses indicate the minimum required distance between the Sensor and Reflector.

Sensitivity Adjustment Unit



Appearance	Sensing distance (typical)	Model	Quantity	Remarks
	300 to 800 mm	E39-E10	1	Can be used with the E3T-ST1□ Through-beam Models.

Mounting Brackets

Appearance	Model	Quantity	Remarks
	E39-L116	1	Can be used with the E3T-S□□□ Side-view Models. (A securing nut plate is provided with the Mounting Bracket.)
	E39-L117		
	E39-L118		
	E39-L119		
	E39-L120		Can be used with the E3T-F□□□ Flat Models.

Note: When using Through-beam models, order one bracket for the Receiver and one for the Emitter.

Sensor I/O Connectors

Size	Cable	Appearance	Cable type	Model	
M12 (For-M1TJ models)	Standard	Straight 	2 m	4-wire	XS5F-D421-D80-A
			5 m		XS5F-D421-G80-A
e-CON	Standard cable	Connector on one end 	2 m	4-wire	E39-ECON2M
			5 m		E39-ECON5M
		Connector on both ends 	0.5 to 1 m		E39-ECONW□M
			1.1 to 1.5 m		
1.6 to 2 m	Replace □ with the cable length in 0.1-m increments.				

Ratings and Specifications

Sensing method	Through-beam				Retro-reflective (without M.S.R. function)			
	Side-view		Flat		Side-view			
	NPN	PNP	NPN	PNP	NPN	PNP	NPN	PNP
	E3T-ST11 E3T-ST12 E3T-ST21 E3T-ST22	E3T-ST13 E3T-ST14 E3T-ST23 E3T-ST24	E3T-FT11 E3T-FT12 E3T-FT21 E3T-FT22	E3T-FT13 E3T-FT14 E3T-FT23 E3T-FT24	E3T-SR21 E3T-SR22	E3T-SR23 E3T-SR24	E3T-SR31 E3T-SR32	E3T-SR33 E3T-SR34
Sensing distance	E3T-ST1□ E3T-ST2□	1 m 300 mm	E3T-FT1□ E3T-FT2□	500 mm 300 mm	E3T-SR2□ 200 mm (10 mm)* (For E39-R4 only)		E3T-SR3□ 100 mm (10 mm)* (For E39-R37 only)	
Standard sensing object	Opaque, 2-mm dia. min.		Opaque, 1.3-mm dia. min.		Opaque, 27-mm dia. min.			
Minimum detectable object (typical)	2-mm dia opaque object		1.3-mm dia opaque object		2-mm dia. (sensing distance of 100 mm)			
Hysteresis (white paper)	---							
Black/white error	---							
Directional angle	Emitter: 2° to 20° Receiver: 2° to 70°		Emitter: 3° to 25° Receiver: 3° min.		2° to 20°			
Light source (wavelength)	Red LED ("Pin-point" LED) λ = 650 nm							
Power supply voltage	12 to 24 VDC ±10%, ripple (p-p) 10% max.							
Current consumption	30 mA max. (Emitter 10 mA max., Receiver 20 mA max.)				20 mA max.			
Control output	Load power supply voltage: 26.4 VDC max. Load current: 50 mA max. (residual voltage: 2 V max. for load current of 10 to 50 mA, 1 V max. for load current of less than 10 mA) Open-collector output Light ON: E3T-□□□1 and E3T-□□□3 Dark ON: E3T-□□□2 and E3T-□□□4							
Protection circuits	Power supply and control output reverse polarity protection Output short-circuit protection				Power supply and control output reverse polarity protection Output short-circuit protection, Mutual interference prevention			
Response time	Operate or reset: 1 ms max.							
Ambient illumination	Incandescent lamp: 5,000 lx max. Sunlight: 10,000 lx max.							
Ambient temperature range	Operating: -25 to 55°C Storage: -40 to 70°C (with no icing or condensation)							
Ambient humidity range	Operating: 35% to 85% Storage: 35% to 95% (with no condensation)							
Insulation resistance	20 MΩ min. at 500 VDC							
Dielectric strength	1,000 VAC, 50/60 Hz for 1 min							
Vibration resistance	Destruction: 10 to 2,000 Hz, 1.5-mm double amplitude or 300 m/s ² for 0.5 hrs each in X, Y, and Z directions							
Shock resistance	Destruction: 1,000 m/s ² 3 times each in X, Y, and Z directions							
Degree of protection	IP67 (IEC60529)							
Connection method	Pre-wired (standard length: 2 m)							
Weight	Approx. 40 g				Approx. 20 g			
Materials	Case	PBT (polybutylene terephthalate)						
	Display window	Denatured polyarylate						
	Lens	Denatured polyarylate				Methacrylic resin		
Accessories	Instruction manual, Installation phillip screws (Side-view Models: M2 × 14, Flat Models: M2 × 8), Nuts, Spring washers, Flat washers, E39-R4 (E3T-SR2□ only), E39-R37 (E3T-SR3□ only)							

* Values in parentheses indicate the minimum required distance between the Sensor and Reflector.

Sensing method	Diffuse-reflective		Convergent-reflective				BGS reflective			
	Flat		Side-view				Flat			
	NPN	PNP	NPN	PNP	NPN	PNP	NPN	PNP	NPN	PNP
	E3T-FD11 E3T-FD12	E3T-FD13 E3T-FD14	E3T-SL11 E3T-SL12	E3T-SL13 E3T-SL14	E3T-SL21 E3T-SL22	E3T-SL23 E3T-SL24	E3T-FL11 E3T-FL12	E3T-FL13 E3T-FL14	E3T-FL21 E3T-FL22	E3T-FL23 E3T-FL24
Sensing distance	5 to 30 mm (50 × 50 mm white paper)		5 to 15 mm (50 × 50 mm white paper)		5 to 30 mm (50 × 50 mm white paper)		1 to 15mm (50 × 50 mm white paper)		1 to 30mm (50 × 50 mm white paper)	
Standard sensing object	---									
Minimum detectable object (typical)	0.15-mm dia. (sensing distance of 10 mm)						0.15-mm dia non-glossy object (sensing distance of 10 mm)			
Hysteresis (white paper)	6 mm max.		2 mm max.		6 mm max.		0.5 mm max.		2 mm max.	
Black/white error	---						15% max.			
Directional angle	---									
Light source (wavelength)	Red LED ("Pin-point" LED) $\lambda = 650 \text{ nm}$									
Power supply voltage	12 to 24 VDC $\pm 10\%$, ripple (p-p) 10% max.									
Current consumption	20 mA max.									
Control output	Load power supply voltage: 26.4 VDC max. Load current: 50 mA max. (residual voltage: 2 V max. for load current of 10 to 50 mA, 1 V max. for load current of less than 10 mA) Open-collector output Light ON: E3T-□□□1 and E3T-□□□3 Dark ON: E3T-□□□2 and E3T-□□□4									
Protection circuits	Power supply and control output reverse polarity protection Output short-circuit protection, Mutual interference prevention									
Response time	Operate or reset: 1 ms max.									
Ambient illumination	Incandescent lamp: 5,000 lx max. Sunlight: 10,000 lx max.									
Ambient temperature range	Operating: -25 to 55°C Storage: -40 to 70°C (with no icing or condensation)									
Ambient humidity range	Operating: 35% to 85% Storage: 35% to 95% (with no condensation)									
Insulation resistance	20 M Ω min. at 500 VDC									
Dielectric strength	1,000 VAC, 50/60 Hz for 1 min									
Vibration resistance	Destruction: 10 to 2,000 Hz, 1.5-mm double amplitude or 300 m/s ² for 0.5 hrs each in X, Y, and Z directions									
Shock resistance	Destruction: 1,000 m/s ² 3 times each in X, Y, and Z directions									
Degree of protection	IP67 (IEC60529)									
Connection method	Pre-wired (standard length: 2 m)									
Weight	Approx. 20 g									
Materials	Case	PBT (polybutylene terephthalate)								
	Display window	Denatured polyarylate								
	Lens	Denatured polyarylate								
Accessories	Instruction manual, Installation phillip screws (Side-view Models: M2 × 14, Flat Models: M2 × 8), Nuts, Spring washers, Flat washers									

I/O Circuit Diagrams

NPN Output

Model	Operation mode	Timing charts	Output circuit
E3T-□□□1	Light-ON	<p>(Between brown and black leads)</p>	<p>Through-beam Receivers, Retroreflective and Reflective Models</p>
E3T-□□□2	Dark-ON	<p>(Between brown and black leads)</p>	<p>Through-beam Emitters</p> <p>Connector Pin Arrangement</p> <p>M12 e-CON</p> <p>Note: Pin 2 is not used. Pins 2 and 4 are not used with Through-beam Emitters.</p>

PNP Output

Model	Operation mode	Timing charts	Output circuit
E3T-□□□3	Light-ON	<p>(Between blue and black leads)</p>	<p>Through-beam Receivers, Retroreflective and Reflective Models</p>
E3T-□□□4	Dark-ON	<p>(Between blue and black leads)</p>	<p>Through-beam Emitters</p> <p>Connector Pin Arrangement</p> <p>M12 e-CON</p> <p>Note: Pin 2 is not used. Pins 2 and 4 are not used with Through-beam Emitters.</p>

Plugs (Sensor I/O Connectors)

M12 Connector

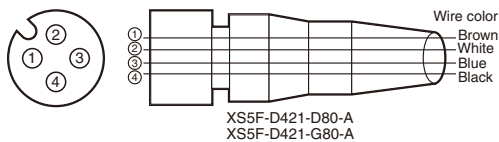

e-CON

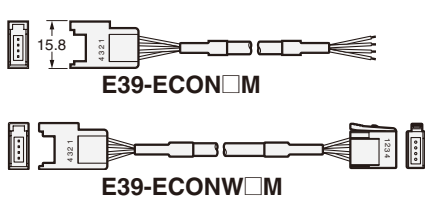

Classification	Wire color	Connector pin No.	Application
DC	Brown	1	Power supply (+V)
	White	2	---
	Blue	3	Power supply (0 V)
	Black	4	Output

Note: Pin 2 is not used.

Dimensions

Sensors

Through-beam Models (Side-view)

E3T-ST1□ (Emitter)
E3T-ST2□ (Emitter)

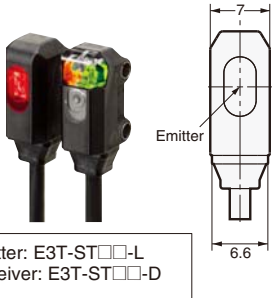

Emitter: E3T-ST□□-L
Receiver: E3T-ST□□-D

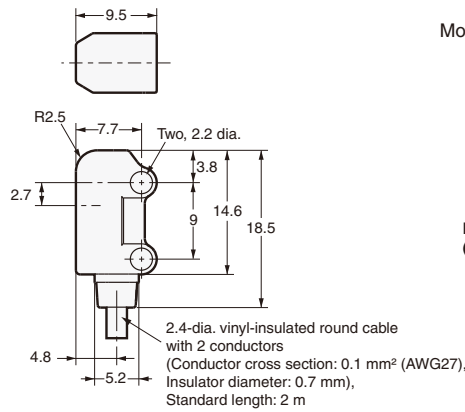

Mounting Holes

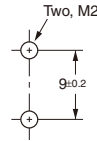

* Refer to *Mounting the Sensor on Moving Parts* on page 13 for details on Robotics Cable models.

M12 Smartclick Pre-wired Connector Model (E3T-ST□□-M12J)

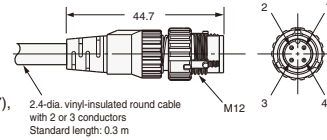

Terminal No.	Specifications
1	+V
2	---
3	0 V
4	Output (receiver only)

E3T-ST1□ (Receiver)
E3T-ST2□ (Receiver)

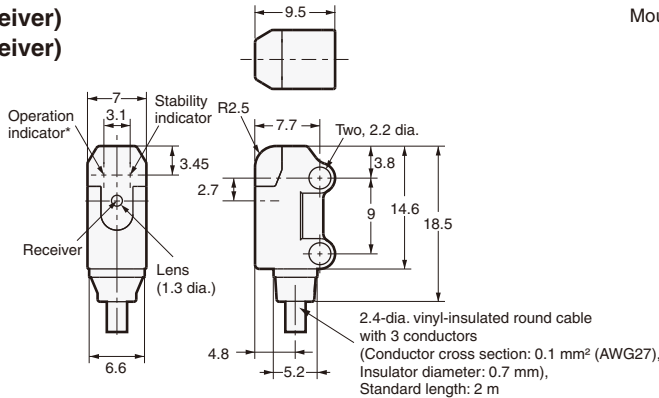

Mounting Holes

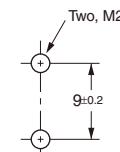

* Refer to *Mounting the Sensor on Moving Parts* on page 13 for details on Robotics Cable models.

e-CON Pre-wired Connector Model (E3T-ST□□-ECON)

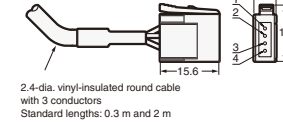

Terminal No.	Specifications
1	+V
2	---
3	0 V
4	Output (receiver only)

Through-beam Models (Flat)

E3T-FT1□ (Emitter)
E3T-FT2□ (Emitter)



Emitter: E3T-FT□□-L
Receiver: E3T-FT□□-D

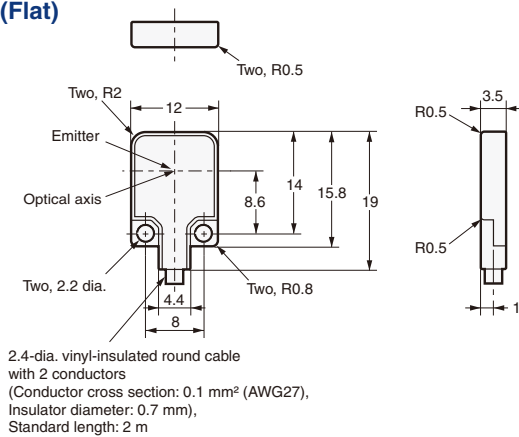

Mounting Holes

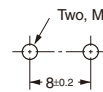

* Refer to *Mounting the Sensor on Moving Parts* on page 13 for details on Robotics Cable models.

M12 Smartclick Pre-wired Connector Model (E3T-FT□□-M12J)

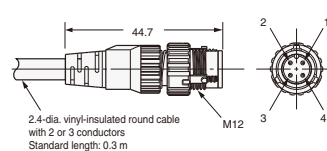

Terminal No.	Specifications
1	+V
2	---
3	0 V
4	Output (receiver only)

E3T-FT1□ (Receiver)
E3T-FT2□ (Receiver)

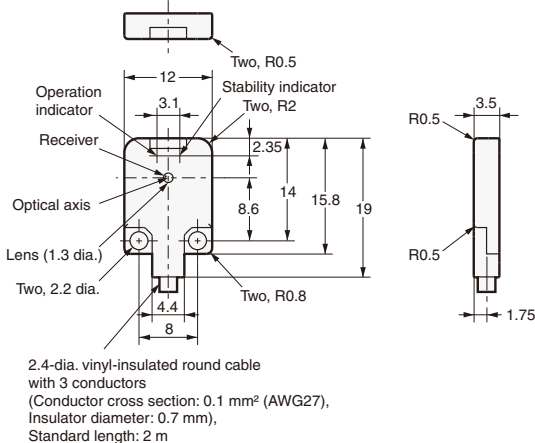

Mounting Holes

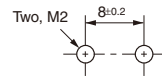

* Refer to *Mounting the Sensor on Moving Parts* on page 13 for details on Robotics Cable models.

e-CON Pre-wired Connector (E3T-FT□□-ECON)

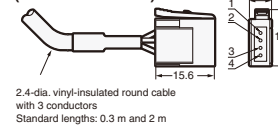

Terminal No.	Specifications
1	+V
2	---
3	0 V
4	Output (receiver only)

Retro-reflective Models (Side-view)

E3T-SR2□
E3T-SR3□

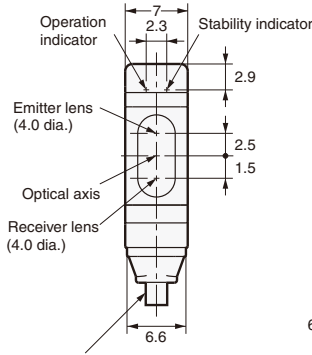

2.4-dia. vinyl-insulated round cable with 3 conductors
(Conductor cross section: 0.1 mm² (AWG27), Insulator diameter: 0.7 mm), Standard length: 2 m

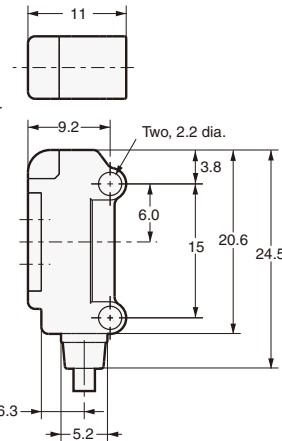

Mounting Holes

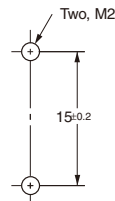

e-CON Pre-wired Connector (E3T-SR□□-ECON)

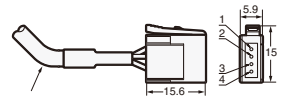

2.4-dia. vinyl-insulated round cable with 3 conductors
Standard lengths: 0.3 m and 2 m

M12 Smartclick Pre-wired Connector Model (E3T-SR□□-M12J)

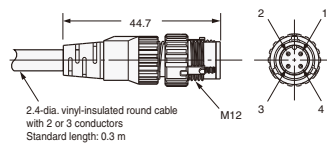

2.4-dia. vinyl-insulated round cable with 2 or 3 conductors
Standard length: 0.3 m

Terminal No.	Specifications
1	+V
2	---
3	0 V
4	Output

* Refer to *Mounting the Sensor on Moving Parts* on page 13 for details on Robotics Cable models.

Diffuse-reflective Models (Flat)

E3T-FD1□

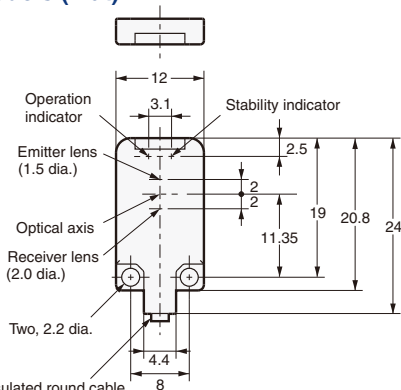

2.4-dia. vinyl-insulated round cable with 3 conductors
(Conductor cross section: 0.1 mm² (AWG27), Insulator diameter: 0.7 mm), Standard length: 2 m

Mounting Holes

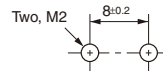

e-CON Pre-wire Connector (E3T-FD□□-ECON)

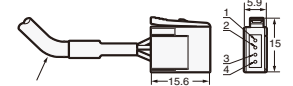

2.4-dia. vinyl-insulated round cable with 3 conductors
Standard lengths: 0.3 m and 2 m

M12 Smartclick Pre-wired Connector Model (E3T-FD□□-M12J)

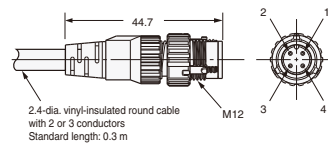

2.4-dia. vinyl-insulated round cable with 2 or 3 conductors
Standard length: 0.3 m

Terminal No.	Specifications
1	+V
2	---
3	0 V
4	Output

* Refer to *Mounting the Sensor on Moving Parts* on page 13 for details on Robotics Cable models.

Convergent-reflective Models (Side-view)

E3T-SL1□
E3T-SL2□

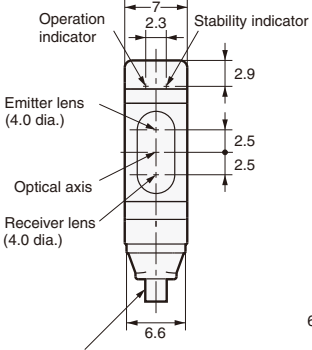

2.4-dia. vinyl-insulated round cable with 3 conductors
(Conductor cross section: 0.1 mm² (AWG27), Insulator diameter: 0.7 mm), Standard length: 2 m

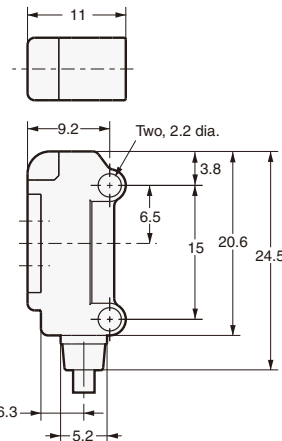

Mounting Holes

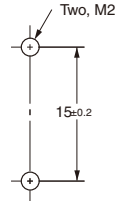

e-CON Pre-wired Connector (E3T-SL□□-ECON)

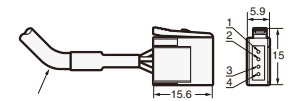

2.4-dia. vinyl-insulated round cable with 3 conductors
Standard lengths: 0.3 m and 2 m

M12 Smartclick Pre-wired Connector Model (E3T-SL□□-M12J)

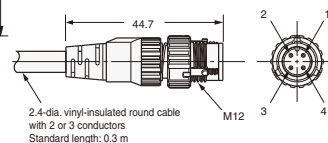

2.4-dia. vinyl-insulated round cable with 2 or 3 conductors
Standard length: 0.3 m

Terminal No.	Specifications
1	+V
2	---
3	0 V
4	Output

* Refer to *Mounting the Sensor on Moving Parts* on page 13 for details on Robotics Cable models.