

2023



Product Version

Gro-Wall® 4.5

Document ID

GW MN MAR 2023

# Gro-Wall®

VERTICAL GARDEN SYSTEM  
VERSION 4.5



18 POT KIT

## Assembly, Installation & Watering Guide

[www.atlantiscorporation.com.au](http://www.atlantiscorporation.com.au)

© 2023 Atlantis International Corporation Pty Ltd All Rights Reserved



# Contents

GRO-WALL® KIT CONTENTS.....	Page 4
GRO-WALL® MODULE OVERVIEW.....	Page 5
STEP 1 - ASSEMBLE GRO-WALL® MODULES.....	Page 6
STEP 2 - CONNECT GRO-WALL® MODULE TOGETHER.....	Page 7
STEP 3 - INSERT LOCKING PINS.....	Page 7
STEP 4 - FASTEN GRO-WALL® MODULES TO WALL.....	Page 8
FIXING SETOUT FOR GRO-WALL® 4.5 MODULES.....	Page 9
INSTALLING GRO-WALL INTO A RECESS.....	Page 10
INSTALLING GRO-WALL ONTO POSTS.....	Page 11
REINFORCED MODULE FOR HANGING APPLICATIONS.....	Page 12
SHORTENING GRO-WALL® MODULES.....	Page 14
IRRIGATION SYSTEM OVERVIEW.....	Page 14
IRRIGATION INSTALLATION.....	Page 15
WATERING SETUP.....	Page 17
PLANTING.....	Page 18
MAINTENANCE.....	Page 19

# GRO-WALL® KIT CONTENTS

Gro-Wall® kits contain components for 6 modules (18 Plant Capacity).



18 GRO-POT® PLANTER TRAYS

**96 CONNECTORS**  
(For connecting modules together & locking planter trays.)



**36 LOCKING CLIPS**



18 GEOTEXTILE PADS

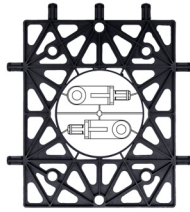

24 DIVIDERS

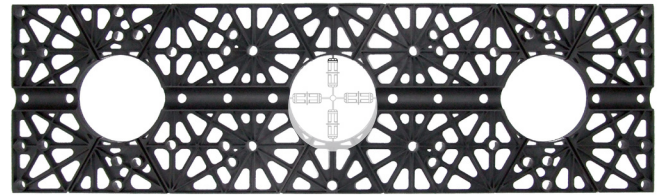

18 LONG PLATES

## REMOVING CLIPS FROM LONG PLATES & DIVIDERS

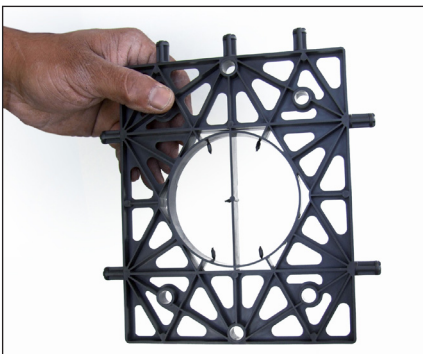

The dividers and long plates come with their clips inside the circular openings.

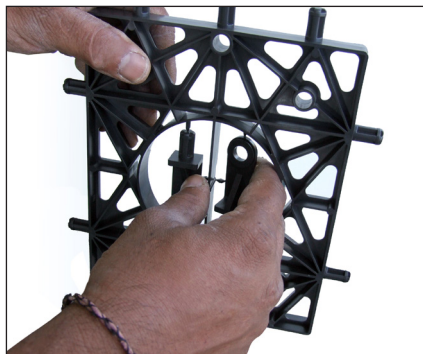

Push or pull the clips loose.

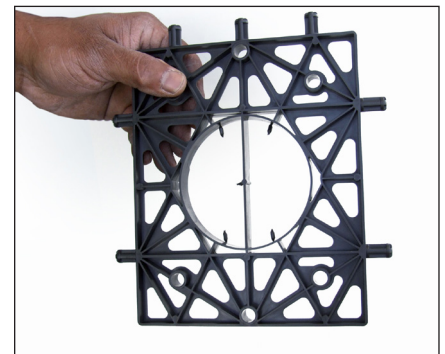

The divider will be left with the plastic strip in the middle. This can be removed if necessary.

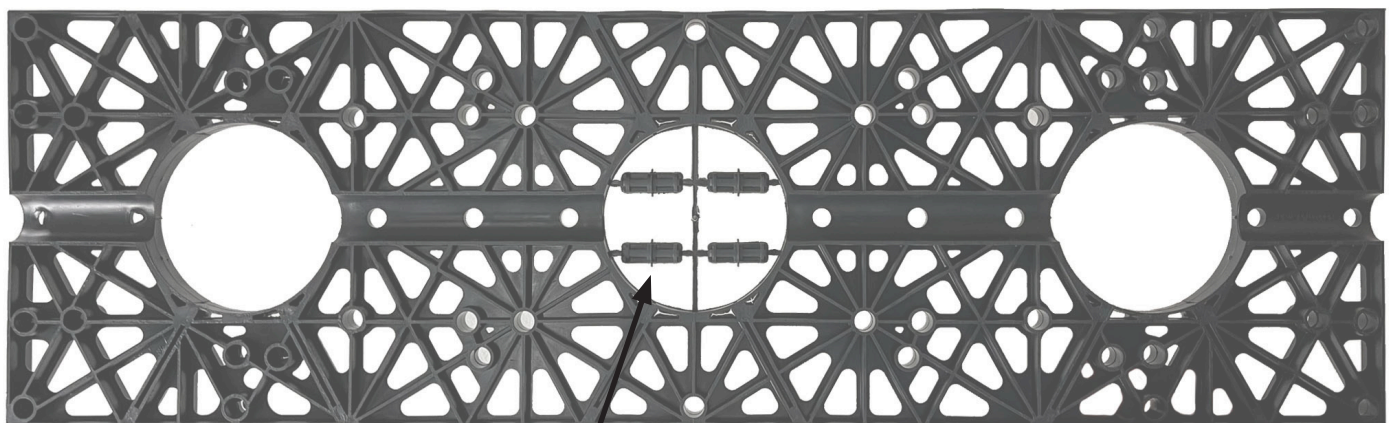

Remove connectors and plastic strips.

# GRO-WALL® MODULE OVERVIEW

Each Gro-Wall® 4.5 module houses 3 planter trays.

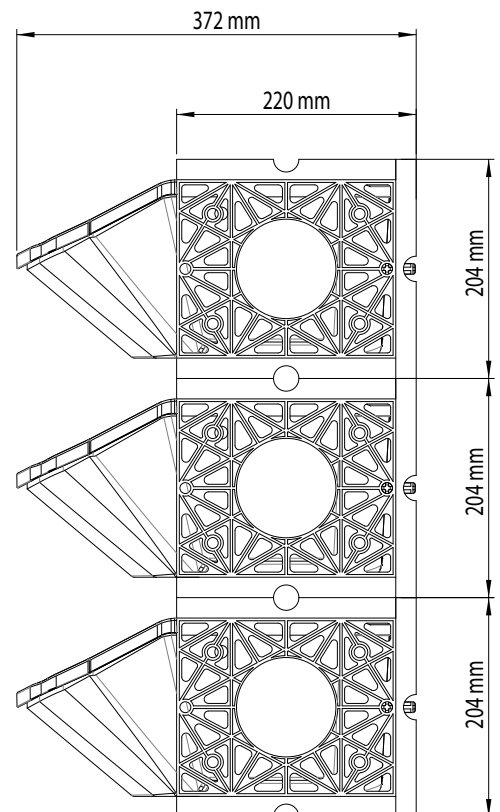
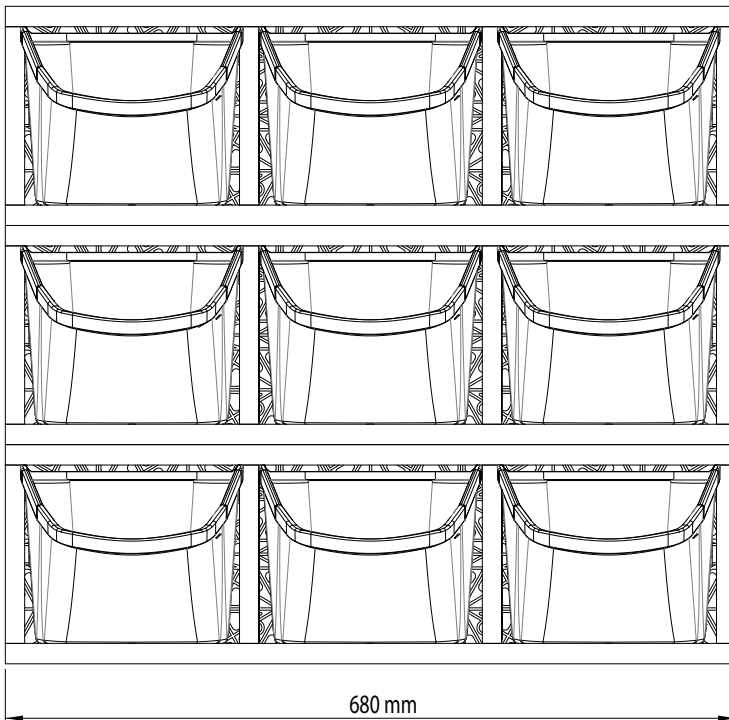
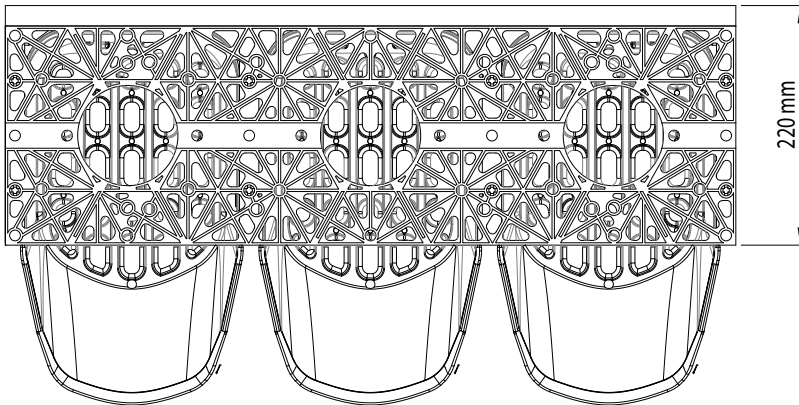

## Gro-Wall® Weight

The Gro-Wall® 4.5 system has a maximum fully planted weight of 210kg per square metre.

Each planter tray including the structure has a maximum fully planted weight of 10kg.

## Gro-Wall® Dimensions

### Gro-Wall® 4.5 Module

**WIDTH:** 680mm (27")

**HEIGHT:** 200mm (8")

**DEPTH:** 220mm (9")

**OVERALL DEPTH:** 372mm (14.6")

# STEP 1 - ASSEMBLE GRO-WALL® MODULES

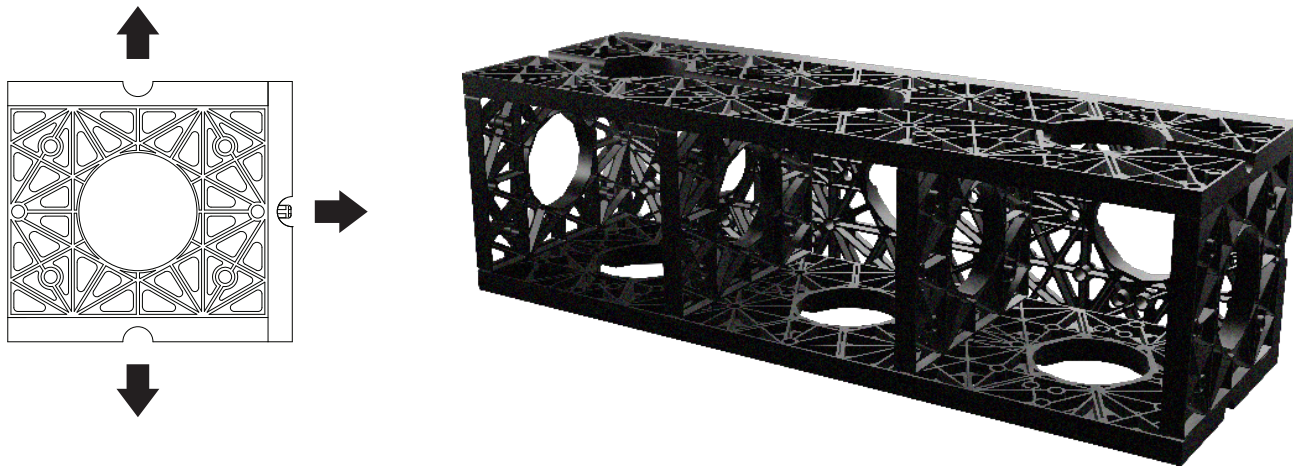

**NOTE:** Channels always face out.

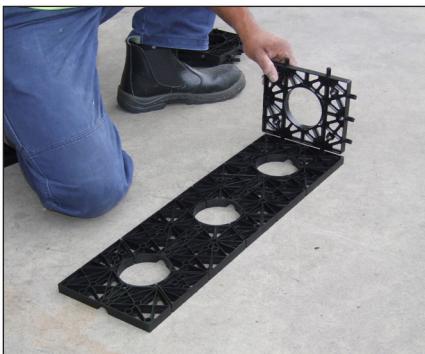

Clip first divider into long plate.  
**Ensure the CHANNEL on the long plate is facing out.**



Clip in 2nd divider.

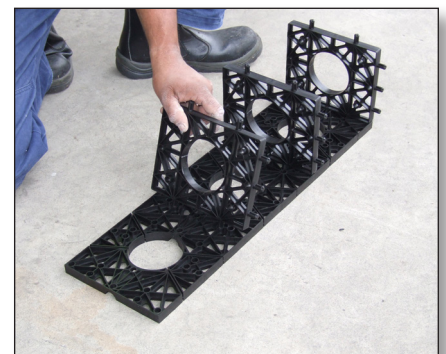

Clip in 3rd divider.

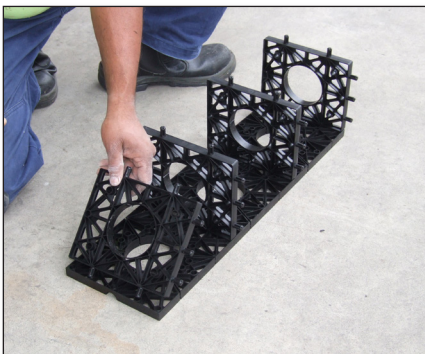

Clip in fourth divider.



Attach top plate.  
**Ensure the CHANNEL on the long plate faces out.**



Turn module over and attach back plate. **Ensure CHANNEL faces out.**

## STEP 2 - CONNECT GRO-WALL MODULE TOGETHER



CONNECTOR PIN

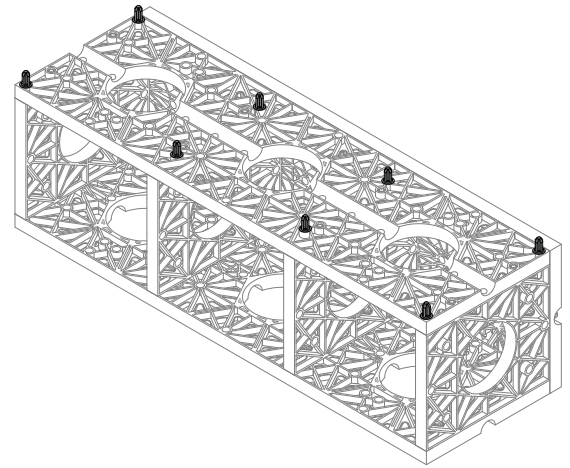
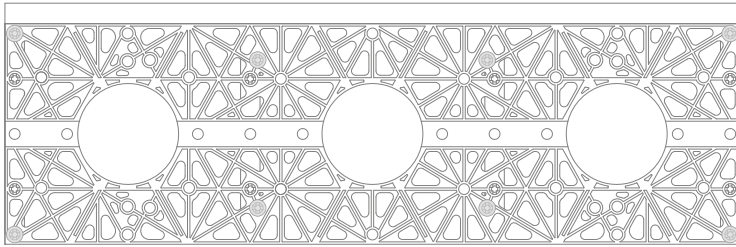

Connect 8 pins to the top of each Gro-Wall® module into the locations indicated above.

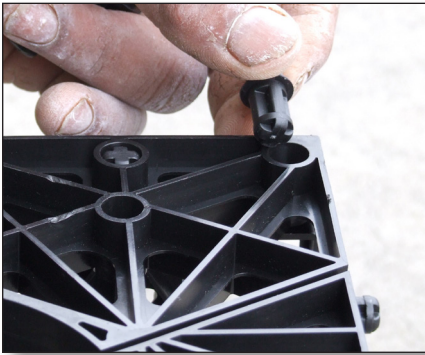

Insert pins into designated locations.

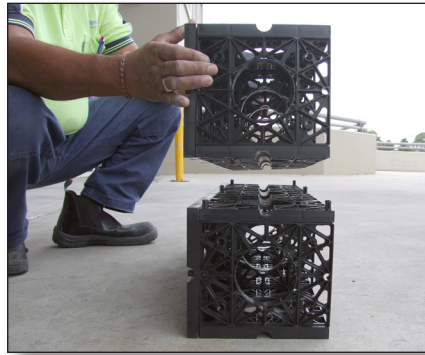

Place Gro-Wall® module directly over module prepared with pins.



Use a rubber mallet and hammer module into place. Repeat steps until desired height is achieved.

## STEP 3 - INSERT LOCKING PINS

Insert LOCKING PIN into desired fixing location.

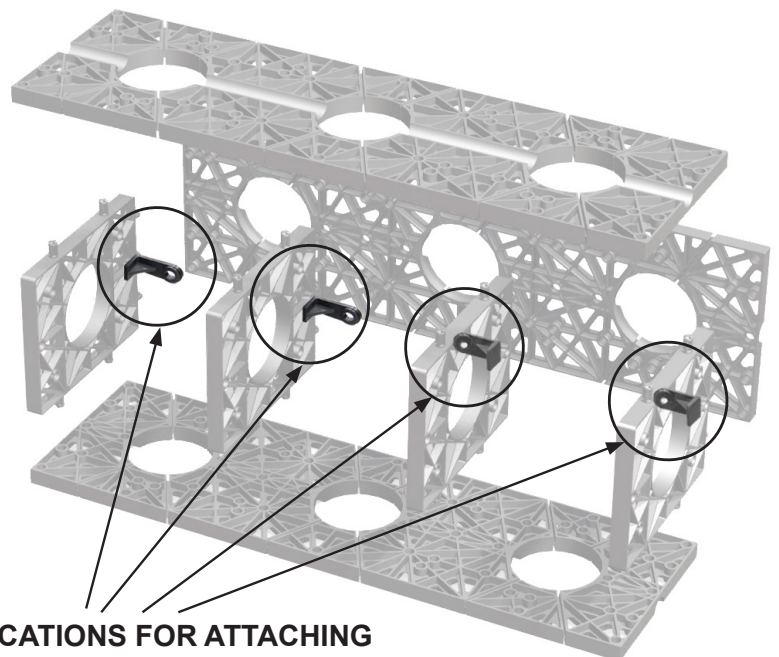
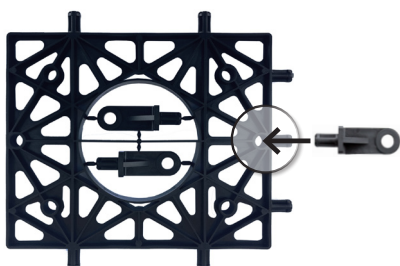

LOCATIONS FOR ATTACHING LOCKING PINS

# STEP 4 - FASTEN GRO-WALL MODULES TO WALL

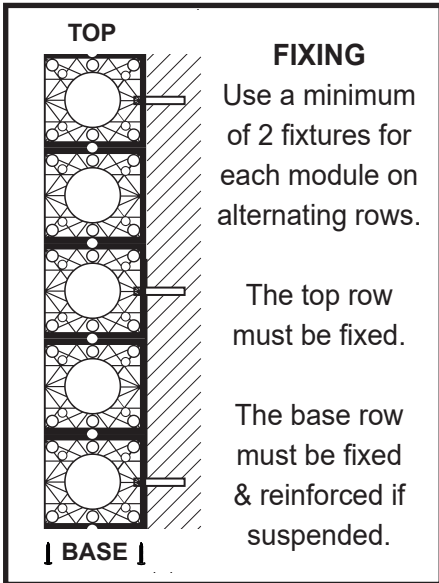

Drill Holes.



Attach fastener.

## FIXTURE LOCATIONS

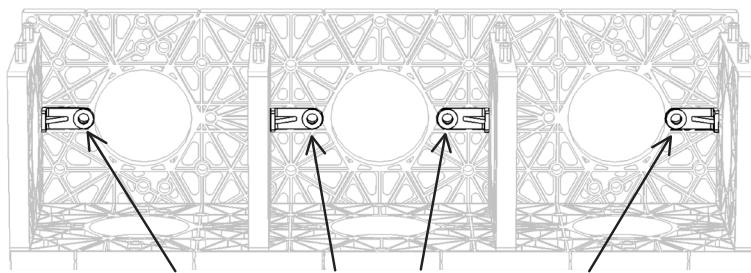

Location of wall anchoring provisions.

Each Gro-Wall® module has 4 provisions for wall anchoring.

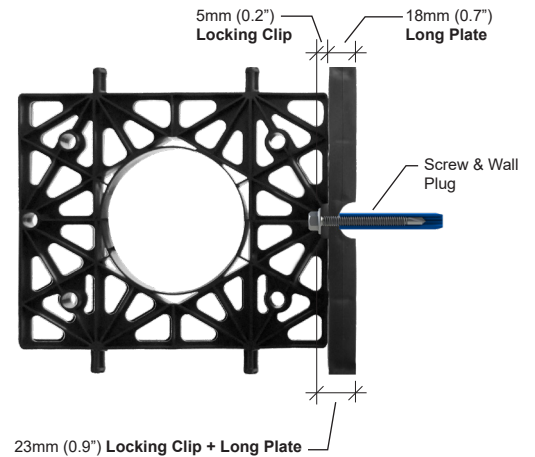

## Fixtures for attaching Gro-Wall® to wall structures

Gro-Wall® can be easily fixed to concrete, brick, sheet metal, timber and other surfaces using appropriate fasteners.

### CONCRETE / BRICK WALL

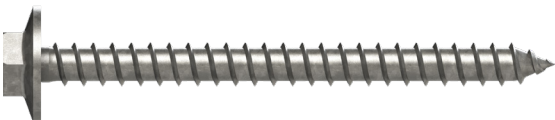

Self Drilling Screw Tek (Minimum 65mm)



8mm Wall Plug

### METAL FRAME

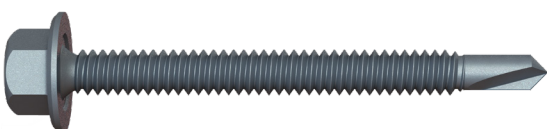

Self Drilling Screw Tek (Minimum 50mm)

### TIMBER FRAME

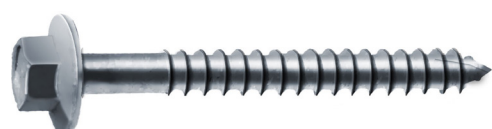

Self Drilling Screw (Minimum 50mm)



# FIXING SETOUT FOR GRO-WALL® 4.5 MODULES

If constructing a frame or fixing battens to a wall then the below dimensions are recommended.

## Single Module - 3 Plant Cells

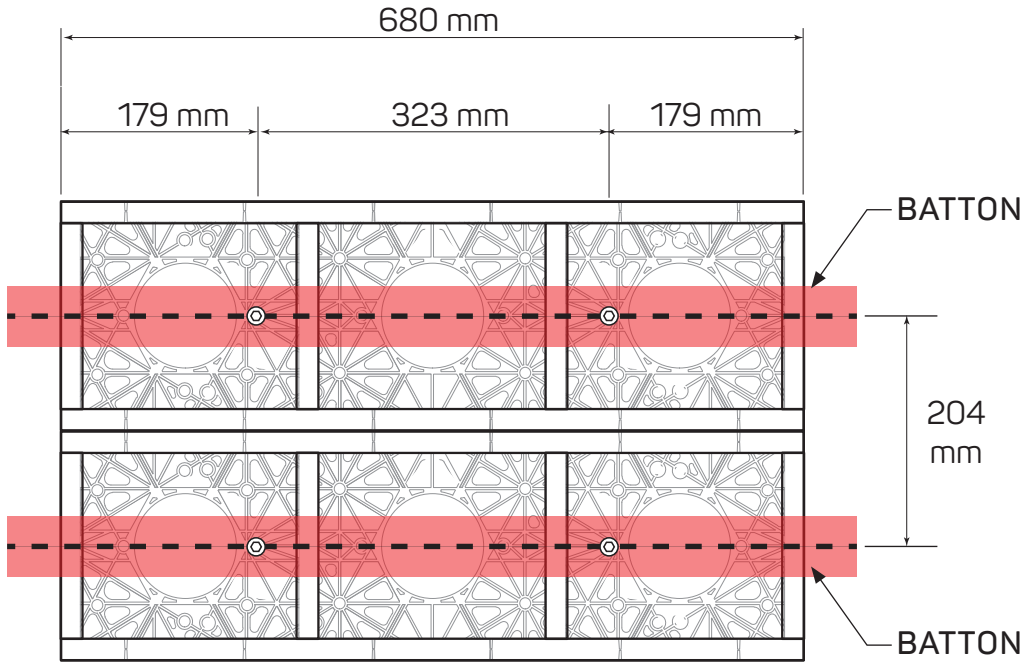

## Modified Module - 2 Plant Cells

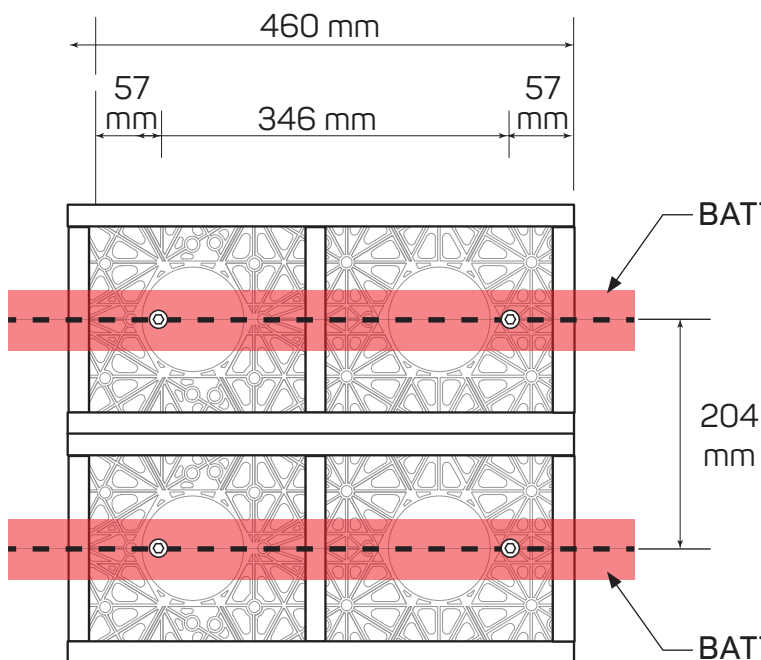

## Modified Module - 1 Plant Cell

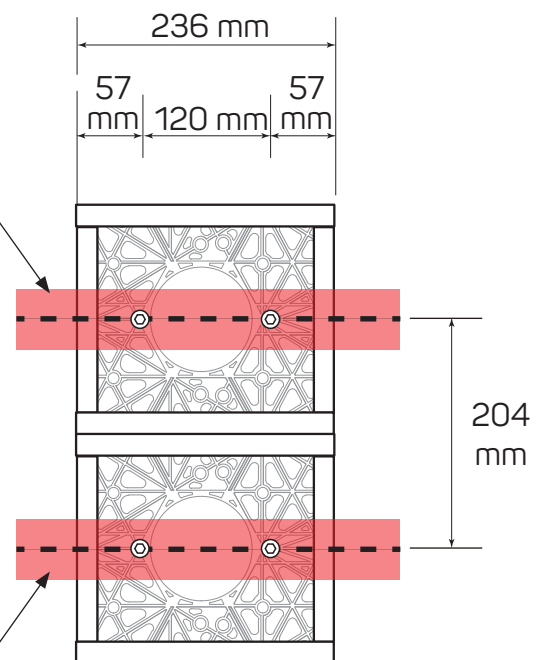

# INSTALLING GRO-WALL® INTO A RECESS

When installing Gro-Wall® 4.5 modules into a recessed cavity we recommend a buffer of 80mm distance per side to allow for the installation and maintenance of the irrigation system. To achieve a flush look the recess distance must be a minimum of 370mm.

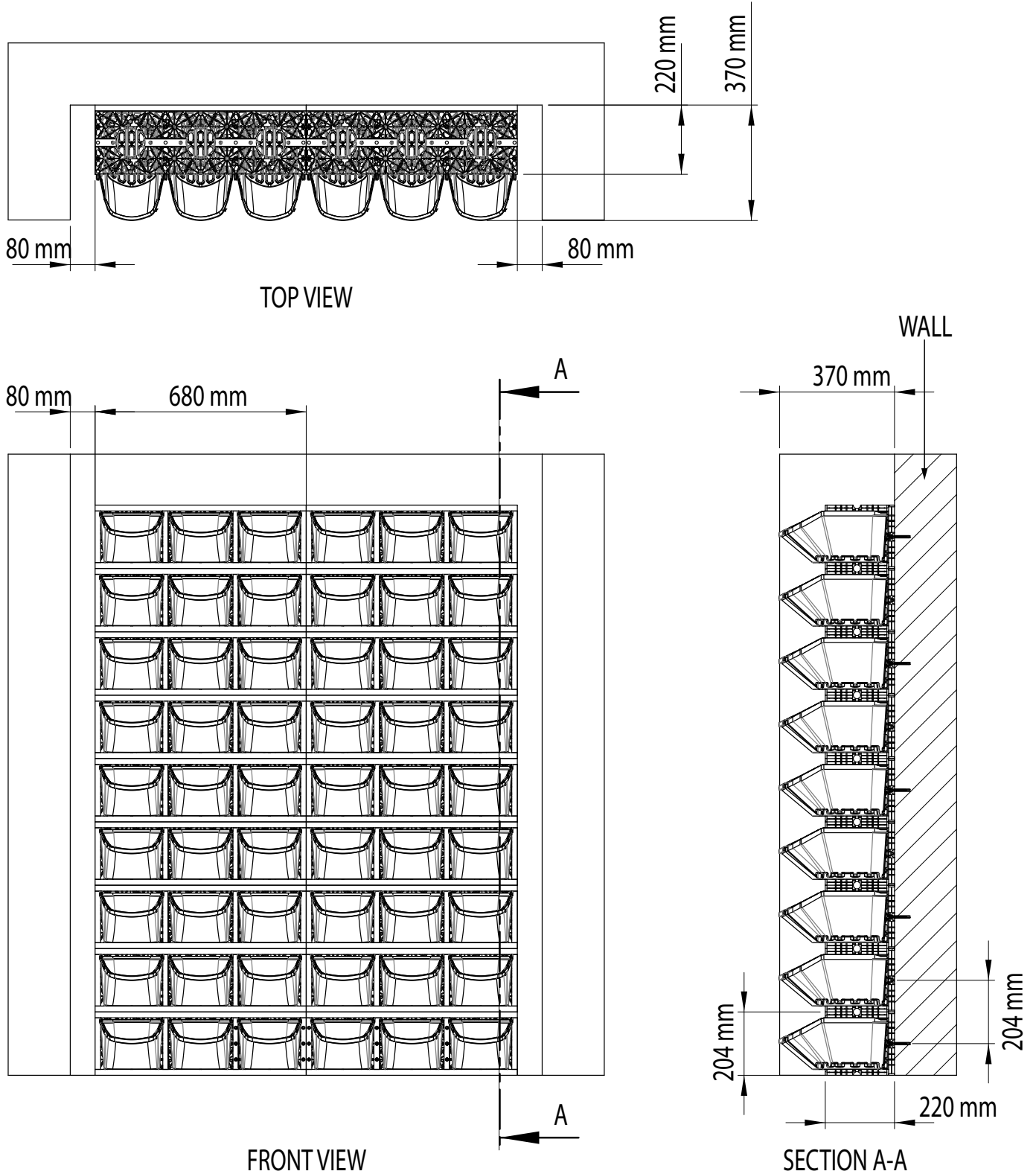

# INSTALLING GRO-WALL® ONTO POSTS

When installing Gro-Wall® 4.5 modules onto steel posts we recommend a setout of posts at 1.2m intervals. For installations up to 2.4m in height 50mm SHS galvanised posts are sufficient. For taller installations please consult structural engineer for recommendations. Battons can be installed horizontally at 204mm centers.

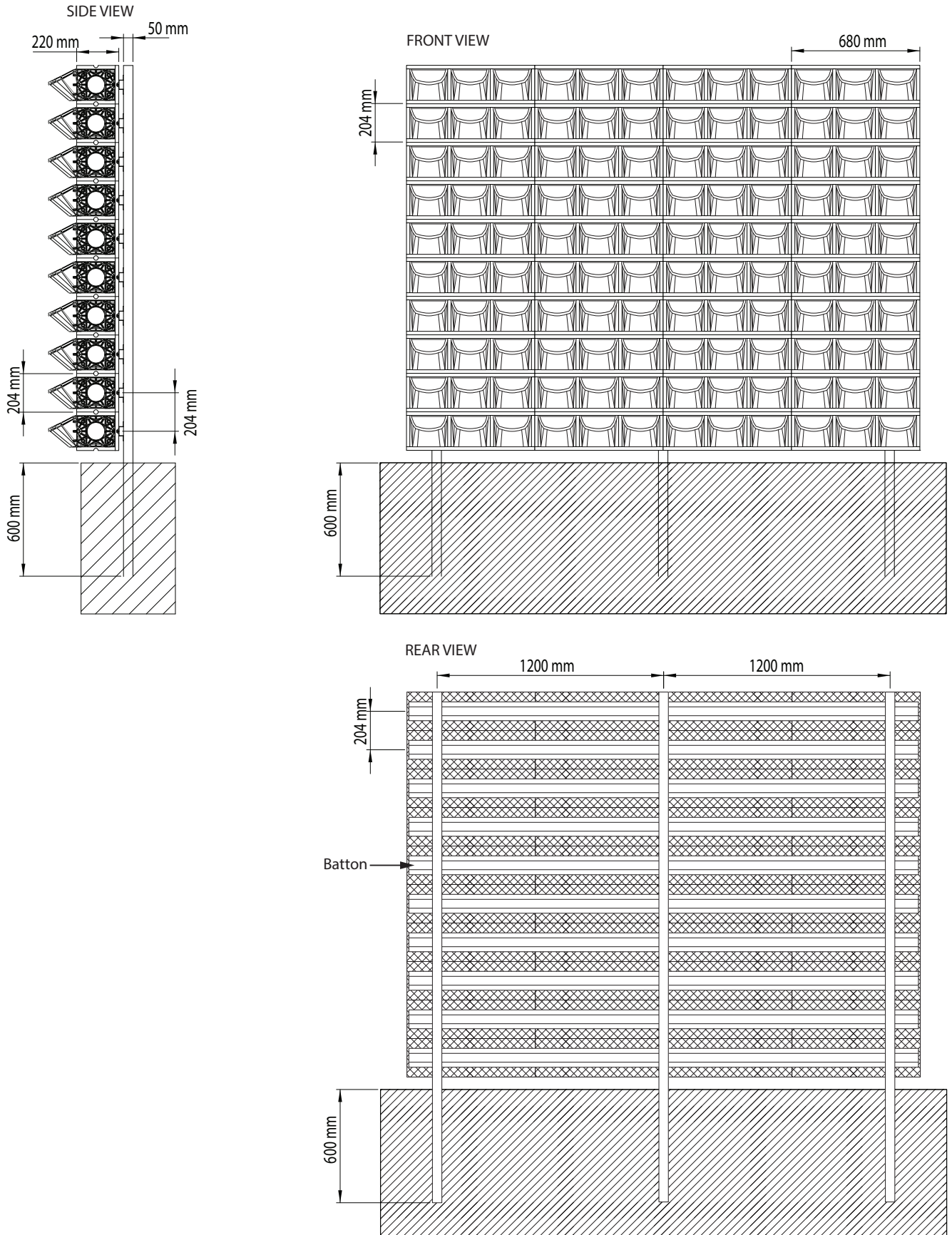

# REINFORCED MODULE FOR HANGING APPLICATIONS

When Gro-Wall® is installed off the ground the bottom row modules requires reinforcement. The reinforcement is achieved by installing screws into designated locations.

## PLACEMENT OF STRUCTURAL MODULES

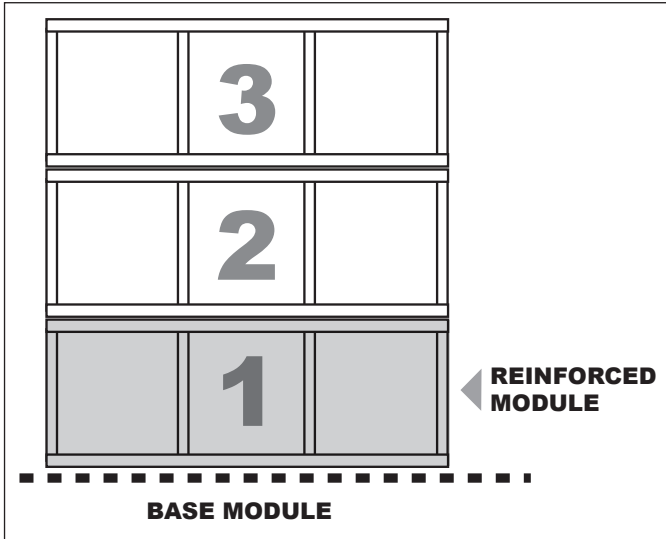

## GALVANISED FASTENERS NEEDED:

QUANTITY	SIZE METRIC	SIZE IMPERIAL	SIZE GAUGE	DESCRIPTION
22	4.2mm	-	8	8G x 32mm Button Head Phillips Drive
22	M5	3/16	-	3/16" & M5 Flat Washer

### 8G BUTTON HEAD SCREW

### 3/16" & M5 FLAT WASHER

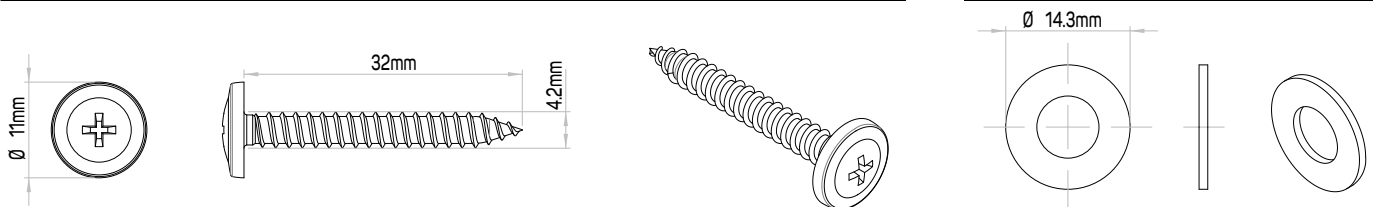

## FASTENING LOCATIONS

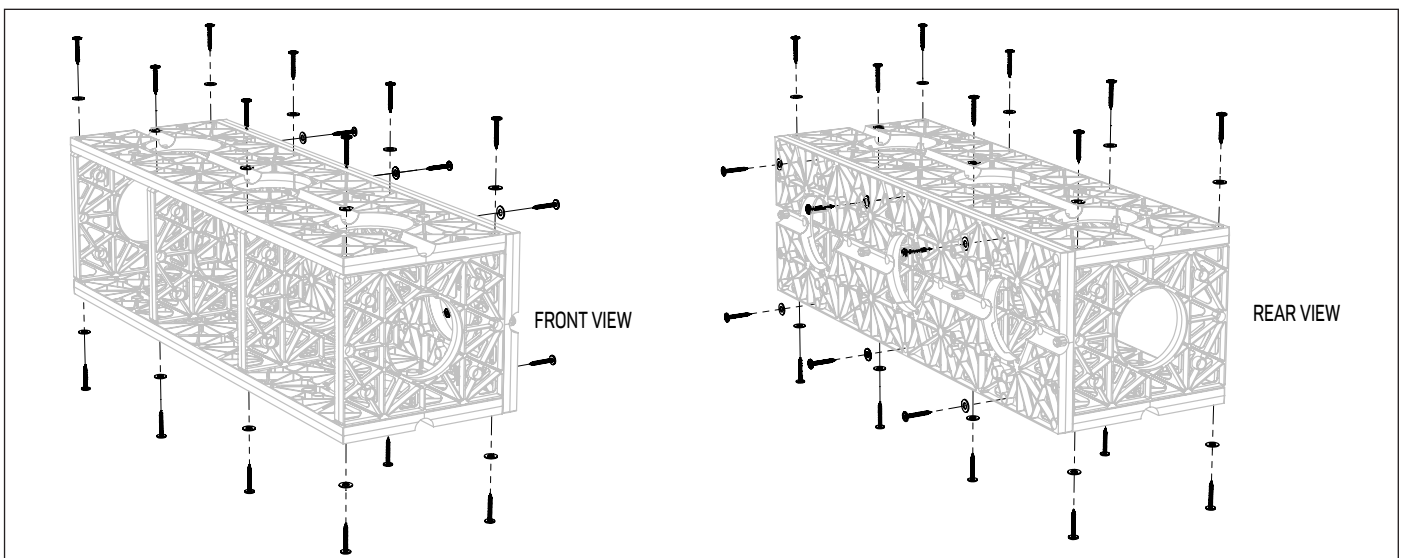

# REINFORCED MODULE SCREW POSITIONS

TOP VIEW

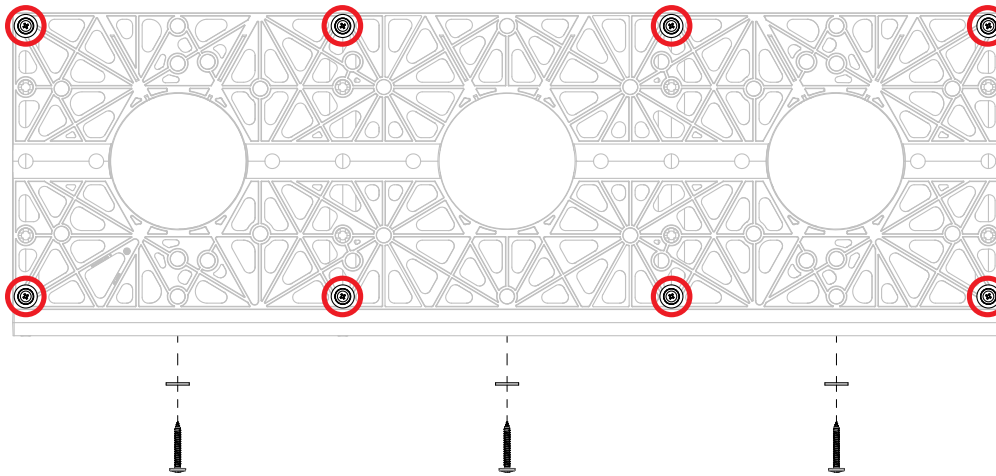

REAR VIEW

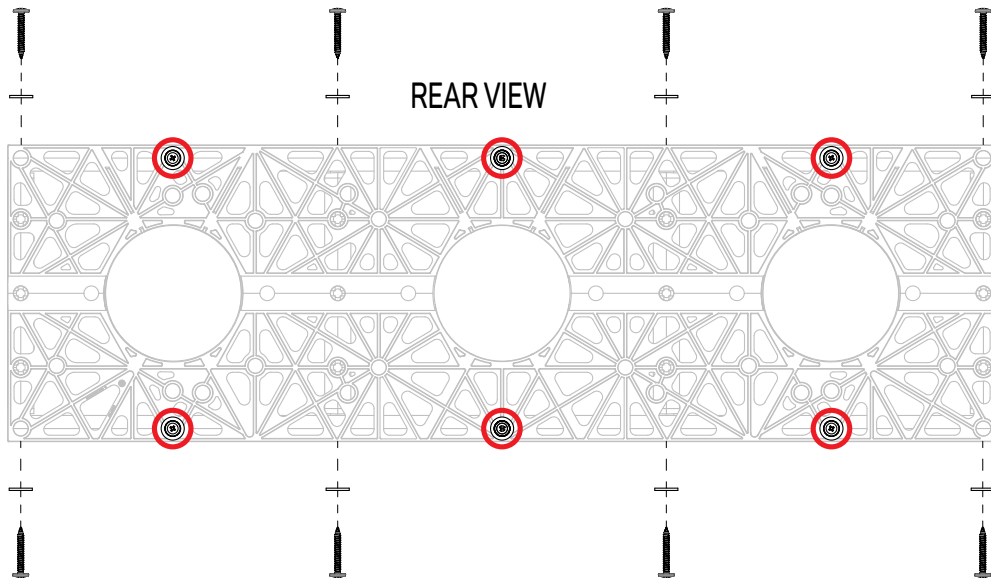

BOTTOM VIEW

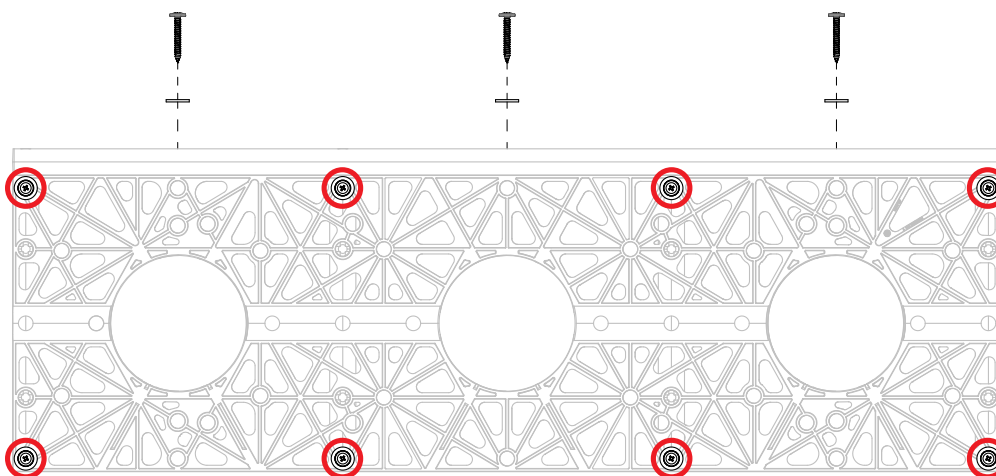

REINFORCED MODULES ARE USED FOR THE BASE ROW OF SUSPENDED APPLICATIONS

# SHORTENING GRO-WALL® MODULES

Gro-Wall® modules can be cut into smaller units for fitting into particular wall widths.

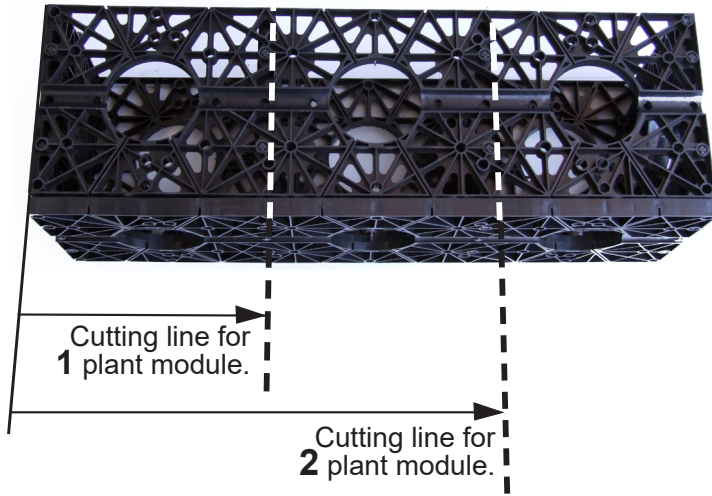

Cutting the module with a circular saw

## Single Module - 3 Plant Cells

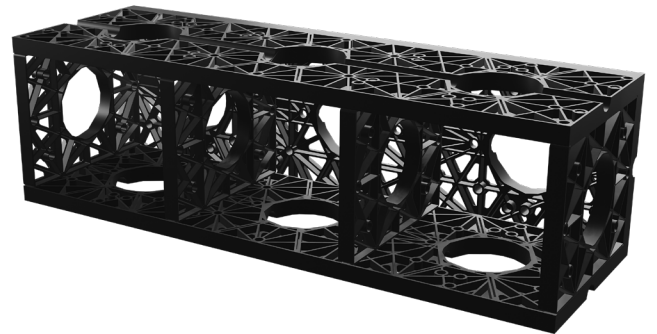
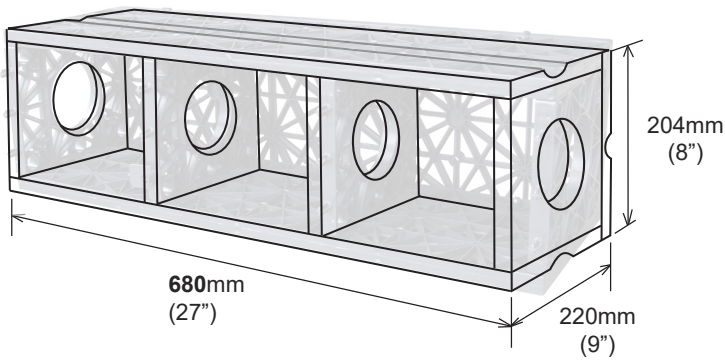

## Modified Module - 2 Plant Cells

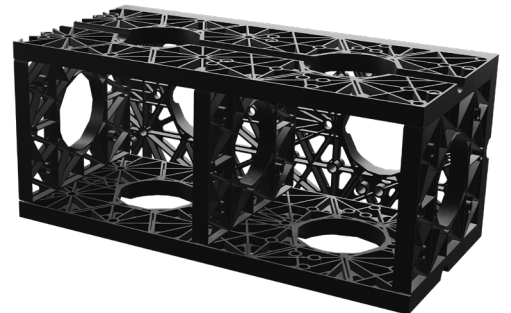
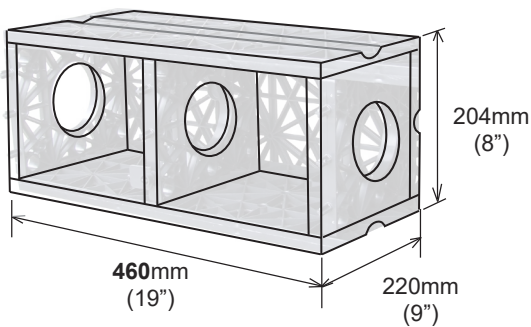

## Modified Module - 1 Plant Cell

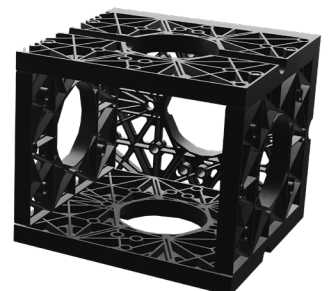
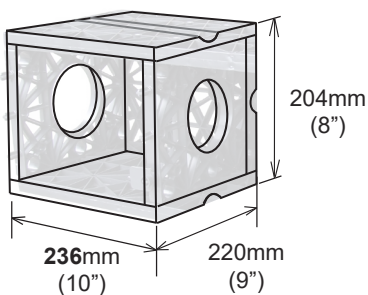

# IRRIGATION SYSTEM OVERVIEW

Gro-Wall® features IPI™ Individual Plant Irrigation provision that allows the installation of a drip emitter on each plant. This system enables the even distribution of water throughout the vertical garden. Watering can be easily tailored to suit various environmental conditions, seasonal changes and plant species.

## Standard Irrigation Components

Typical 13mm (0.51") and 19mm (0.74") irrigation fittings and connectors are compatible with Gro-Wall®.

### TYPICAL IRRIGATION SETUP

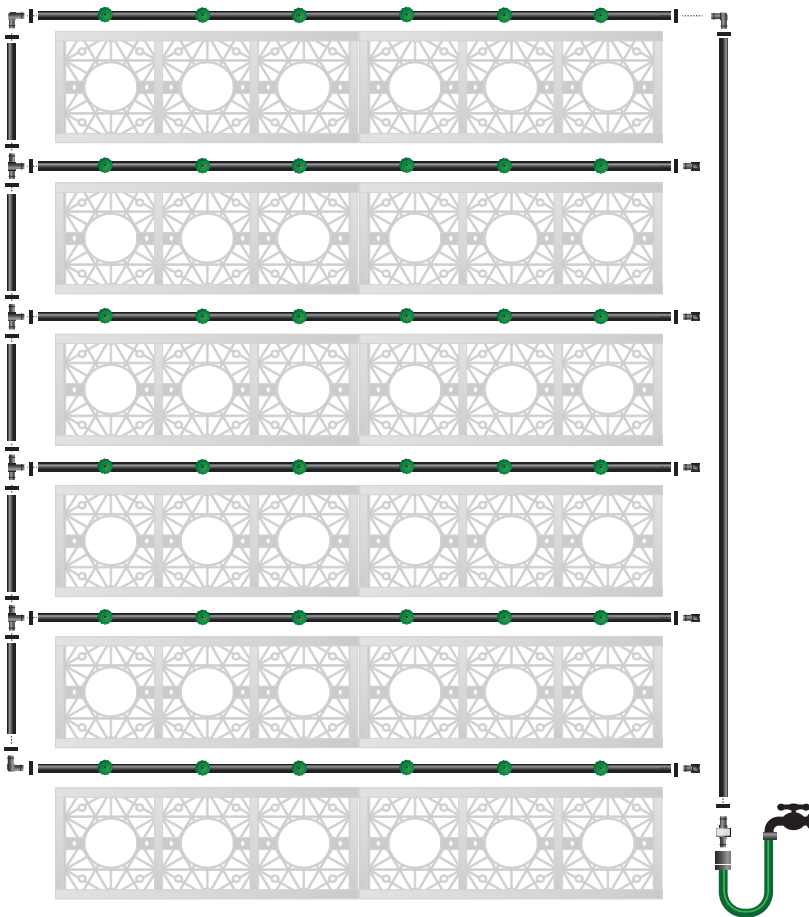

### IRRIGATION REQUIREMENTS FOR:

6 Module Vertical, 2 Module Wide

PART	QUANTITY
POLY IRRIGATION PIPE	10.5m (34.5ft)
DRIP EMITTERS (2 l/h)	36
END CAP	5
TEE	4
ELBOW	1
CLAMP	24

### COMPONENTS

(Not included)



POLY IRRIGATION PIPE

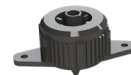

DRIP EMITTER 2 l/h



ELBOW



END CAP



TEE



CLAMP

**Installation Tip:** It is easier to line up the irrigation tube, then punch the holes BEFORE the pipe is inserted between the layers (due to size/space restriction) Then install nozzles once pipe is in place.

# IRRIGATION INSTALLATION

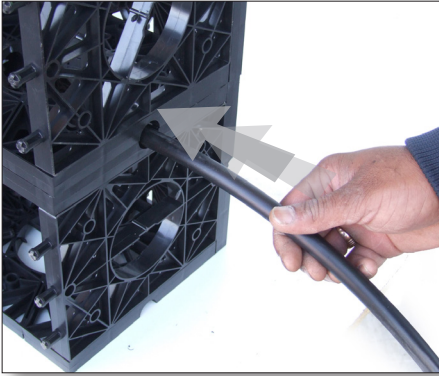

Insert the poly irrigation pipe and cut to size.

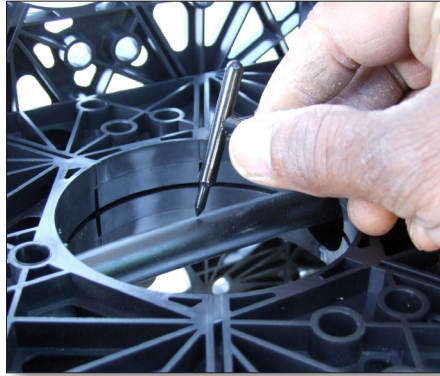

Puncture the poly irrigation pipe from the top first.

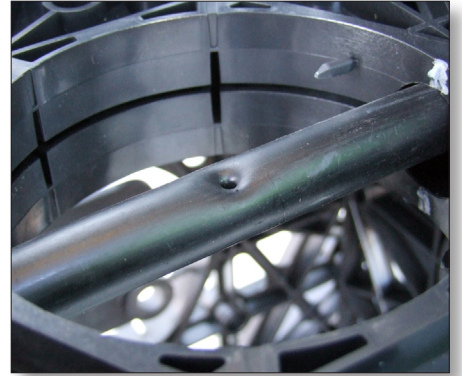

Punctured poly irrigation pipe.



Insert drip emitter.

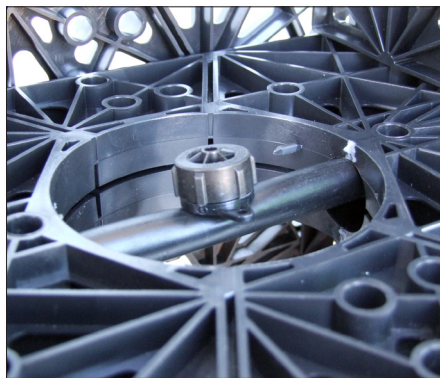

Installed Drip Emitter.

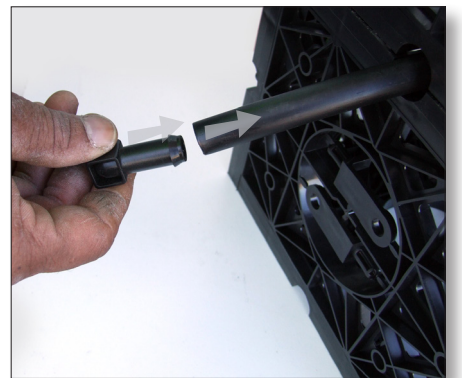

Insert the End Cap of that row.

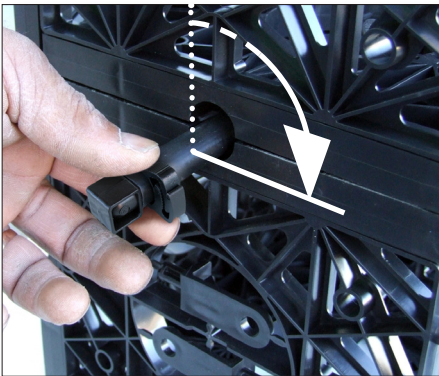

..and turn 90° forwards.

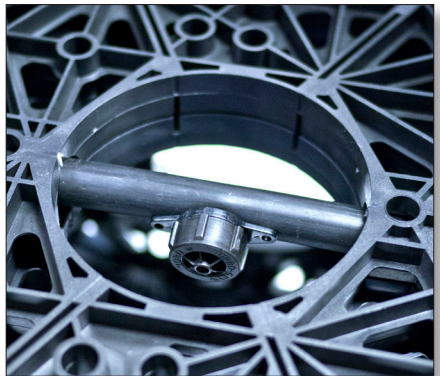

Correct Drip Emitter Position.



Insert the Tee-Connector at the other end.

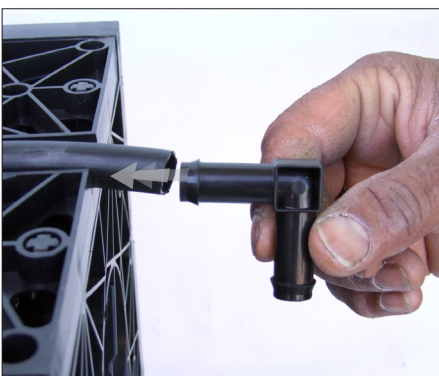

Connect elbow to the top of the module.

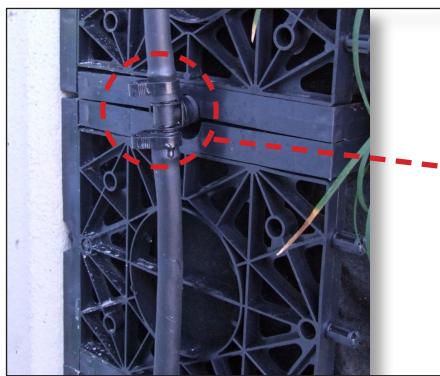

Connect all tee connectors on the side with a piece of 13mm tube and clamp.

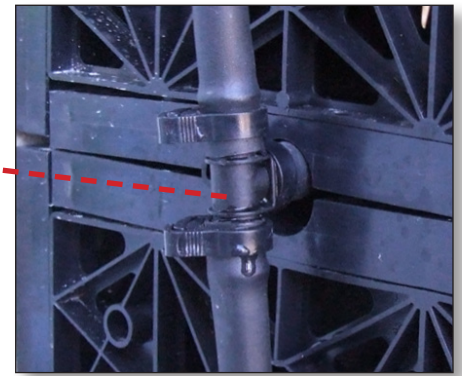



# WATERING SETUP

## TO SET UP IRRIGATION CYCLE TIMING

### STEP 1

Turn on the irrigation system to water the plants.

### STEP 2

When the planting media is sufficiently moist turn off irrigation. Note the runtime of the watering and use this to program the timer.

### STEP 3

Monitor the planting media over the course of a week and observe the moisture level in the planting media. Repeat irrigation cycle when the moisture level is low.

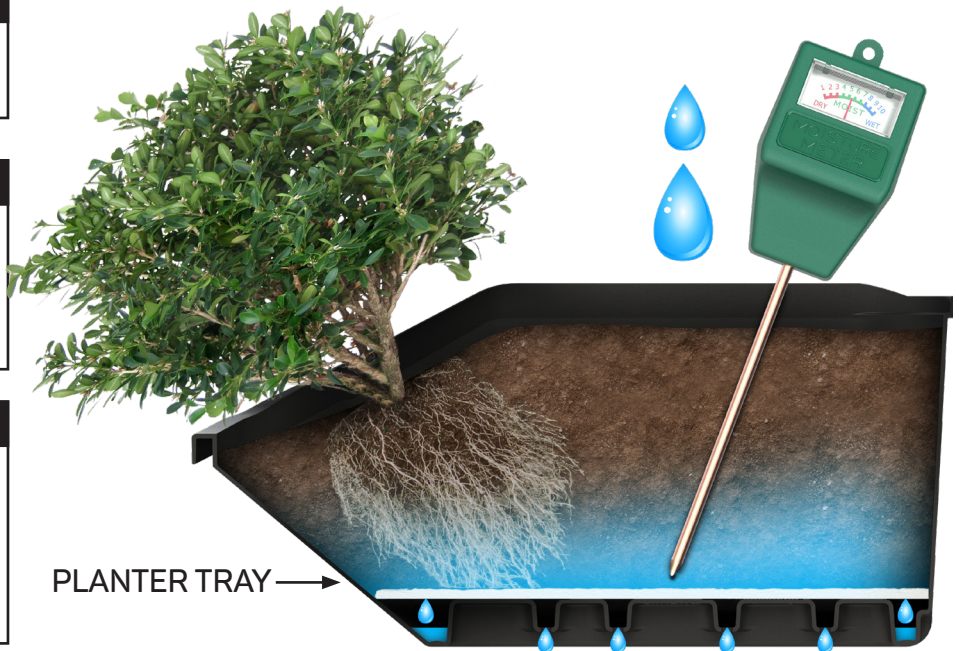

## IRRIGATION TIMER EXAMPLE

### IRRIGATION SETUP USING 2 LITRE PER HOUR DRIP EMITTERS (2 L/H)

3 Watering days per week, 3 Minutes Runtime for each day. Each planter tray receives a total 300ml per week.

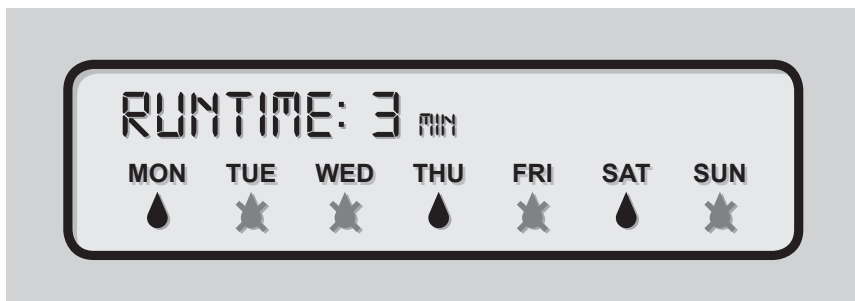

**Note:** The above process is an example only. The irrigation timing should be customised for each installation.

## IRRIGATION CAPACITY

GRO-WALL® 4.5 has 21 Drip Emitters per square metre.

When using 2 L/hr drip emitters this will provide a capacity of 42 L/hr.

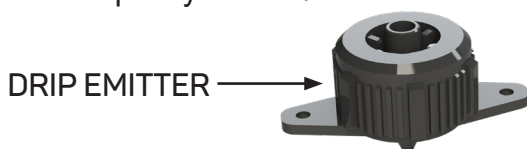

## WATER CONSUMPTION

The moisture levels in the soil mix will change over time due to the following;

- Seasonal Changes
- Hot & Cold Weather
- Wind Conditions
- Water Consumption by Plant
- Air Humidity

# PLANTING

## Growing Media

Recommended planting media should consist of a combination of inorganic and organic material that is free draining . Use of quality organics is recommended. Soils that contain clay cannot be used.



Potting Mix  
(Organic Matter)



Coco Peat / Coya  
(Organic Matter)



Fertilizer  
(Pelletized)



Inorganic Material  
(Volcanic Rock, Perlite,  
Vermiculite, Recycled  
Agregate)

## Planting

Gro-Wall® 4 kits contain planter trays with a high quality geotextile pad. The planter trays provide excellent drainage and moisture retention for optimal plant growth. The planter tray design allows easy access and maintenance.



Empty planter tray.



**Step 1** - Place geotextile pad into base of planter tray.



**Step 2** - Pour in half of soil mix.



**Step 3** - Position plant into planter tray.



**Step 4** - Compact soil mix around plant.



**Step 5** - Fill remainder of planter tray with soil mix.

# MAINTENANCE

## Working at Heights

---

Ensure that all work conducted at heights is in accordance with the safety regulations of the state or territory you are working in. For tall installations that require rope access, must be performed by accredited trained staff with appropriate licences and permits.

## Green Waste & Pruning

---

Gro-Wall® installations must be maintained on a regular basis to ensure healthy plant growth. The main considerations are to keep the plants free from green waste. Some plant species will require pruning as their growth may overshadow other plants species located below in the Gro-Wall® installation and prevent their growth due to a lack of light. Pruning of plant species that grow over underlying plants will ensure the overall success of the Gro-Wall® installation. If pruning is required ensure this is done on a regular basis to coincide with the plant growth.

## Inspect & Test Irrigation System

---

The irrigation system must be checked on a regular basis to ensure operational success. Irrigation drip emitters can fail over time and this can cause a lack of water to individual plants which can lead to plant death. Generally drip emitters will provide many years of functional operation. Faulty drip emitters can be readily replaced during the maintenance program. If any individual plants fail, it may be an indicator that there is a faulty drip emitter.

## Adjust Irrigation Timing

---

The timing of the irrigation system must be adjusted to suit the environmental location of the installation. Generally the timing is adjusted during the maintenance period.

## Add Fertiliser

---

Fertiliser can be added every 6 months to 12 months.



# Gro-Wall<sup>®</sup>

**VERTICAL GARDEN SYSTEM**  
VERSION 4.5



ATLANTIS INTERNATIONAL CORPORATION PTY LTD

Phone: (02) 9417 8344

Fax: (02) 9417 8311

Email: [info@atlantiscorp.com.au](mailto:info@atlantiscorp.com.au)

Web: [www.atlantiscorp.com.au](http://www.atlantiscorp.com.au)

**Note:** Atlantis products are manufactured from carefully selected high quality recycled materials. The strength of the recycled plastic could vary slightly due to raw material composition, country of manufacture, manufacturing process and external conditions. All trademarks are the property of Astral Property Pty Ltd.

**Disclaimer:** All information provided in this publication is correct to the best knowledge of the company and is given out in good faith. This information is intended only as a general guide, no responsibility can be accepted for any errors, omissions or incorrect assumption. As each project is unique, and as Atlantis International Corporation Pty Ltd and its distributors and agents world wide have no direct control over the methods employed by the user in specifying, installing or supervising of its products hence no responsibility is accepted by Atlantis International Corporation Pty Ltd and its distributors and agents world wide. Users should satisfy themselves as to the suitability of the product for their purpose. All product designs, and specification are subject to change without further notice. All Atlantis products are tested in approved laboratories, and safe allowed tolerances should be practised in the actual field, to compensate for any unforeseen situations, on site and on products. All material contained within this brochure is subject to copyright, and belongs to Atlantis International Corporation Pty Ltd. No part of this brochure may be reproduced or transmitted in any form or by any means, electronic, mechanical, photocopying, recording or otherwise, without prior written permission of Atlantis International Corporation Pty Ltd. Copyright @ 2023