



»» 7' x 12' Storage Shed

Features:

- 7' x 12' | 1.5" x 38mm POWDER COATED STEEL frame
- 7' W x 12' D x 7.37' CH : SH 71.26" DH 68.9" DW 51.18"
- Steel Footpad
- Horizontal side support bars for additional stability
- 180 gram Grey polyethylene cover
- Fully Enclosed: 1 -Piece Top and Sides
- Removable Front Wall
- Front End wall with Roll Up Door (three zippers)
- Solid rear end wall

The Storage Shed offers superior protection from rain, sun and snow. Great for storing garden tools, mowers, snow blowers, snowmobiles, ATVs, pool items, or anything you need to store out of sight.

4aj 6[We[a` e~ I VYZf,
)"Ž` j #%j +ž` ###28%
 Tež

Front wall
 Roll up door







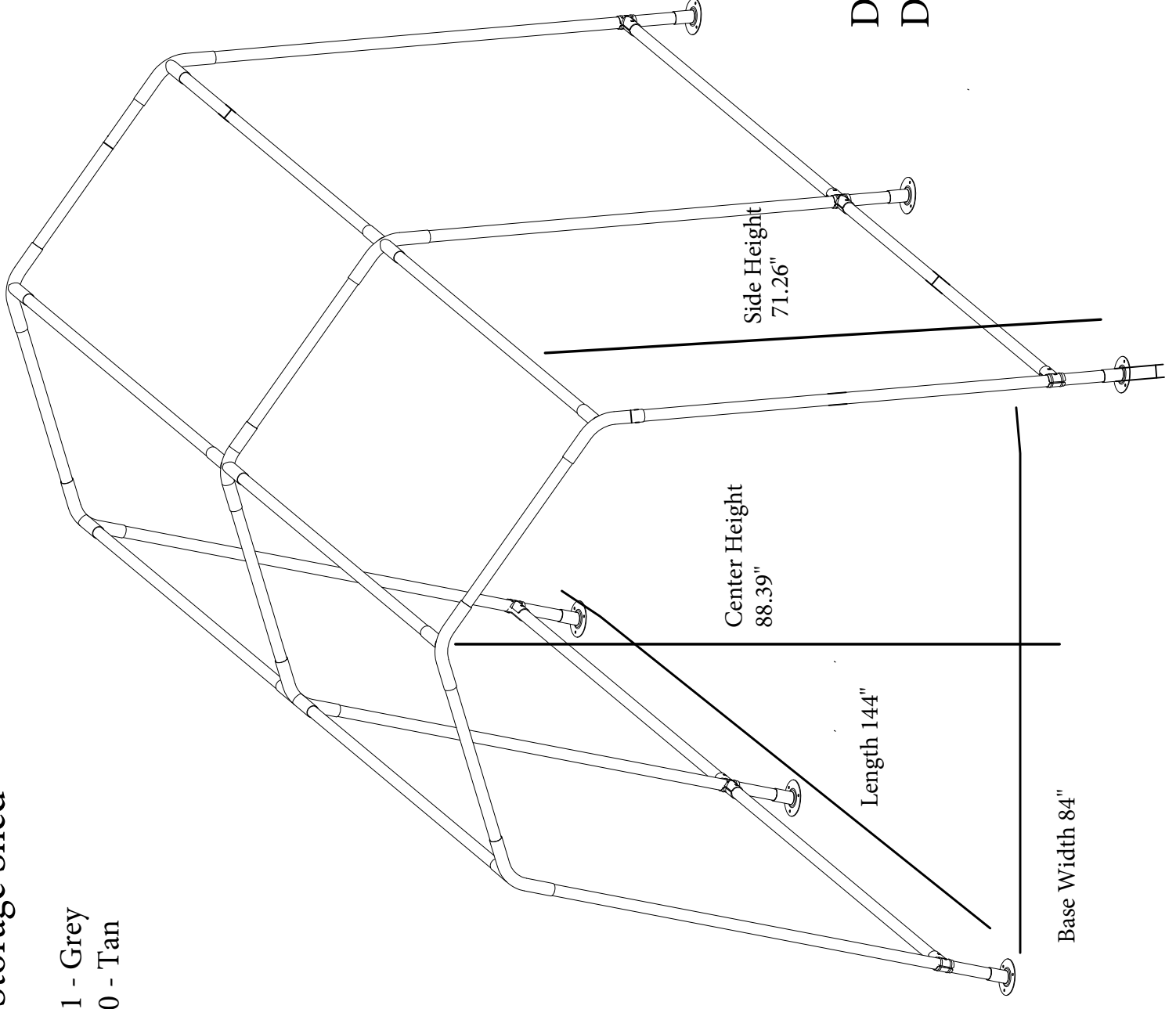

Impact Canopy USA 22600 Temescal Canyon Rd.
 Corona, CA 92883 - US: 877.840.3524 x 2043

7' x 12' Storage Shed

070018151 - Grey
070018150 - Tan

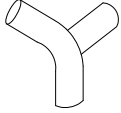
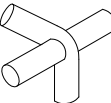
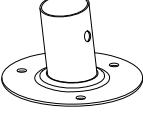

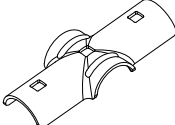
Door Width: 51.18"
Door Height: : 68.9"

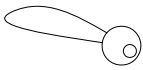
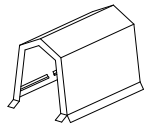
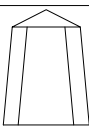
PART	ILLUSTRATION	QTY
A	400701611  %ž · EfS[YZf b]bW	6
B	40070612  (*ž+ · EfS[YZf b]bW	16
C	400701613  %I SkEZWxfi` YXd#ž · b]bW	6
D	400701614  &i SkEZWxfi` YXd#ž · b]bW	3
E	400701615  3` YW_ Ws^xfi` YXd#ž · b]bW	6
F	400701680  E]` YWqVWUS_ b	8
G	400701681  6agT`WqVWUS_ b	4
H	400701682  4af` ` gf	6
I	400701683  >aU Taf i SeZW` ` gf	8
J	070019907  Elastic ball bungee 8"	32
L	070142012  1-Piece Cover : top sidewalls & end wall	1
M	070341007  Front end wall w/ zippered roll up door	1

1.

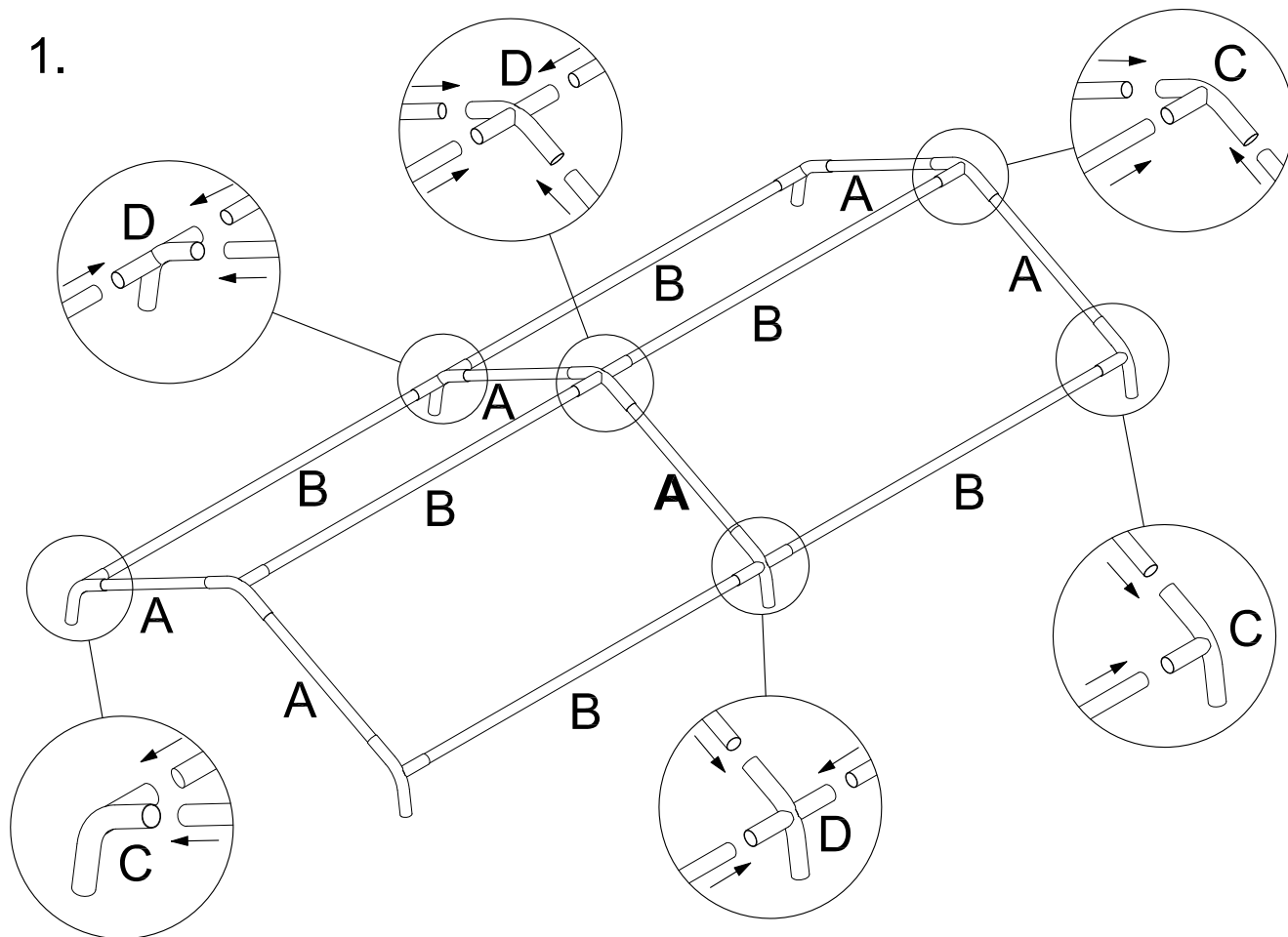

2.

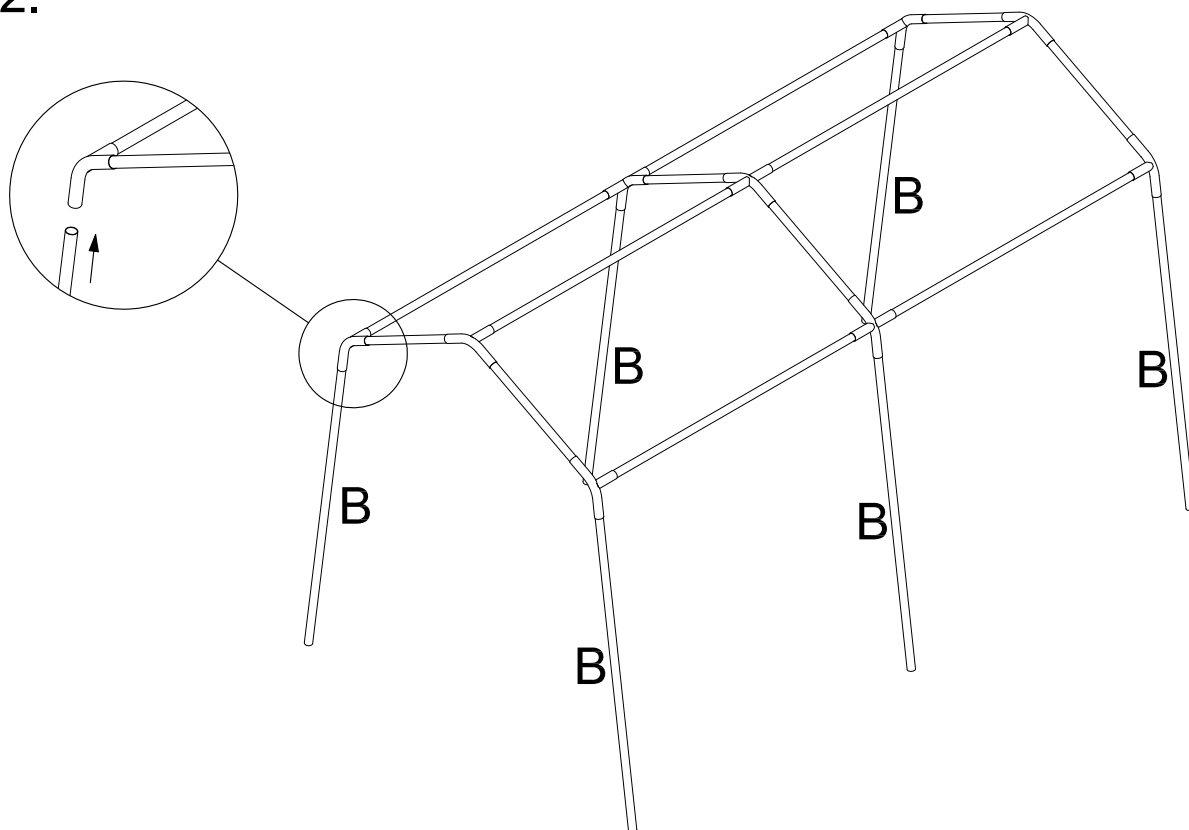

3.

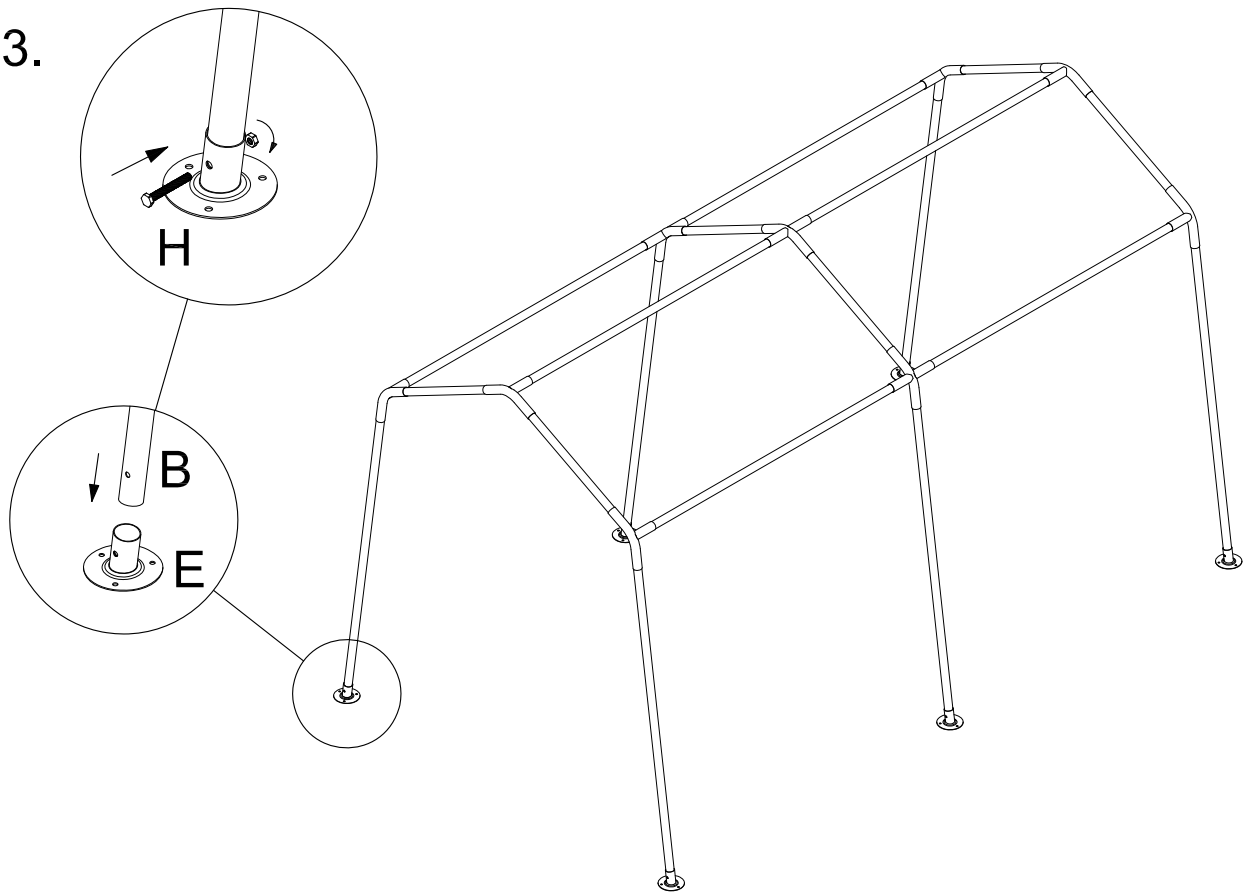

4.

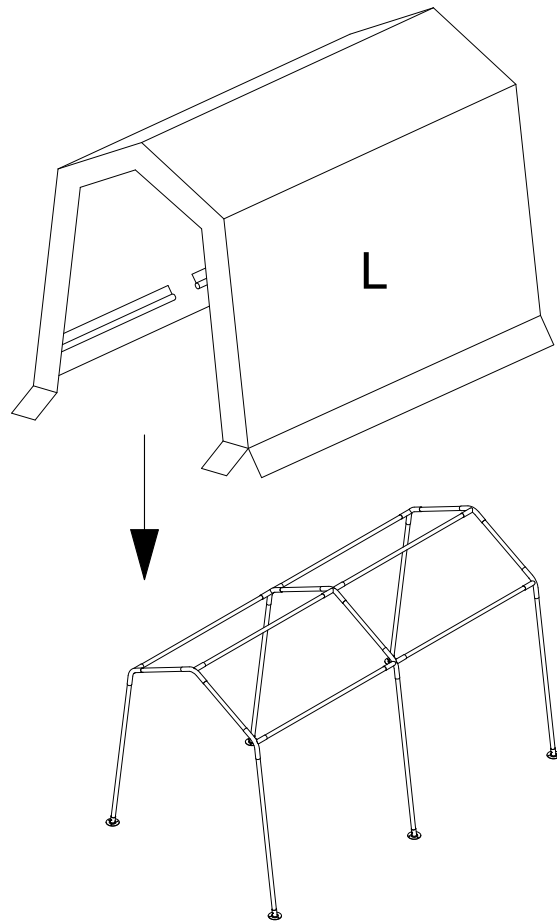

5.

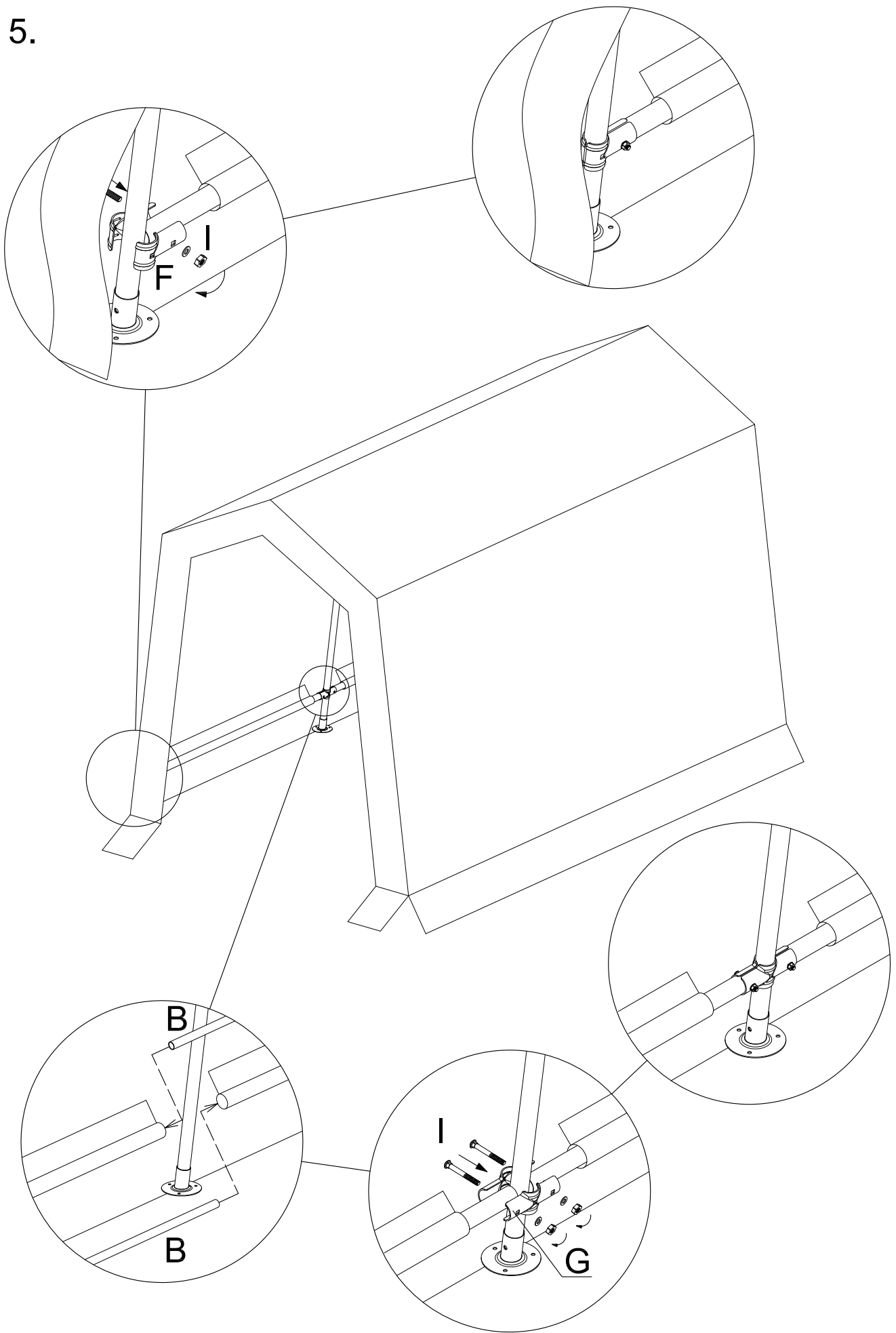

6.

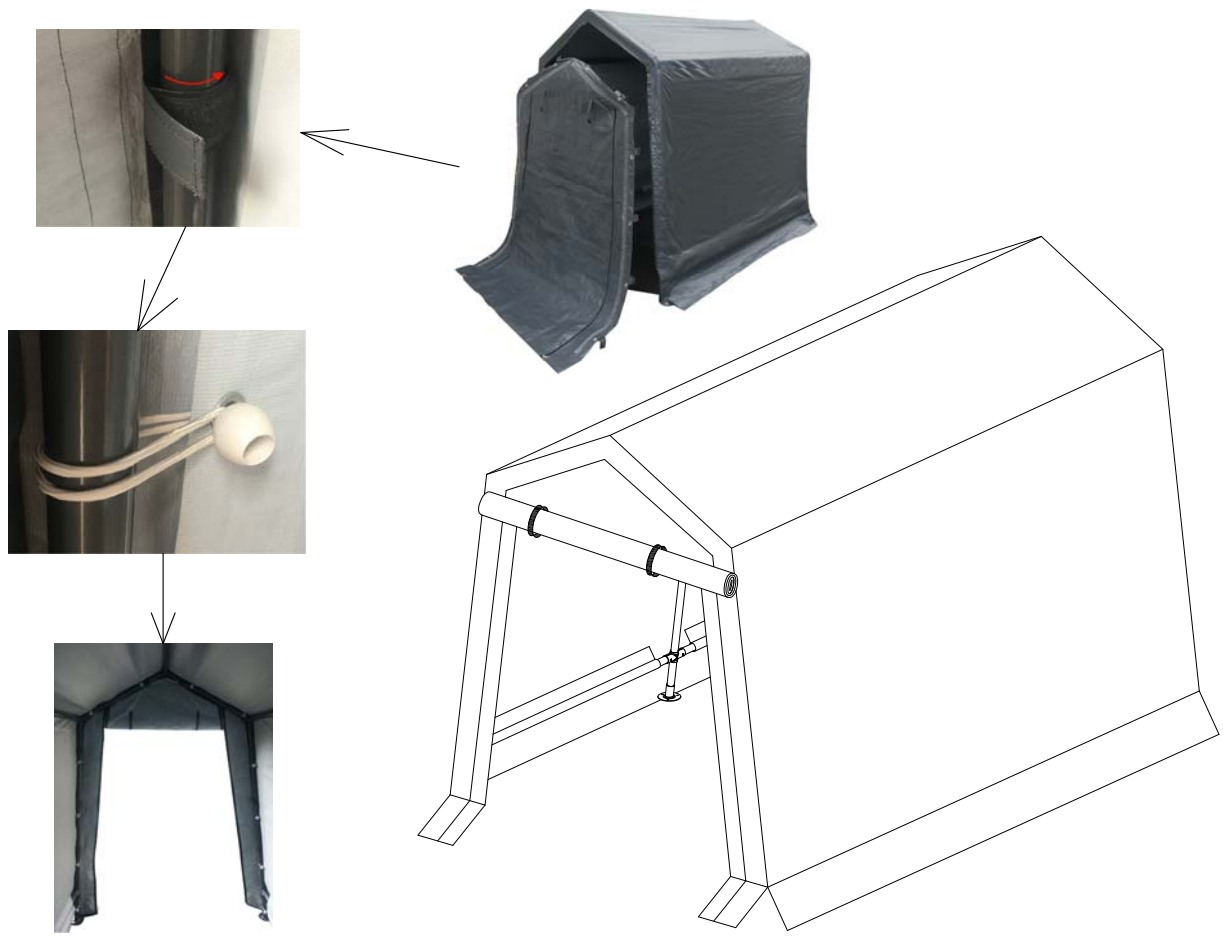

7.

