



**SHORT DESCRIPTION**

**GP #**

**UPC #**

**SPECIFICATIONS:**



**ACCESSORIES SOLD SEPARATELY**

**DESCRIPTION**

**SHORT DESCRIPTION**







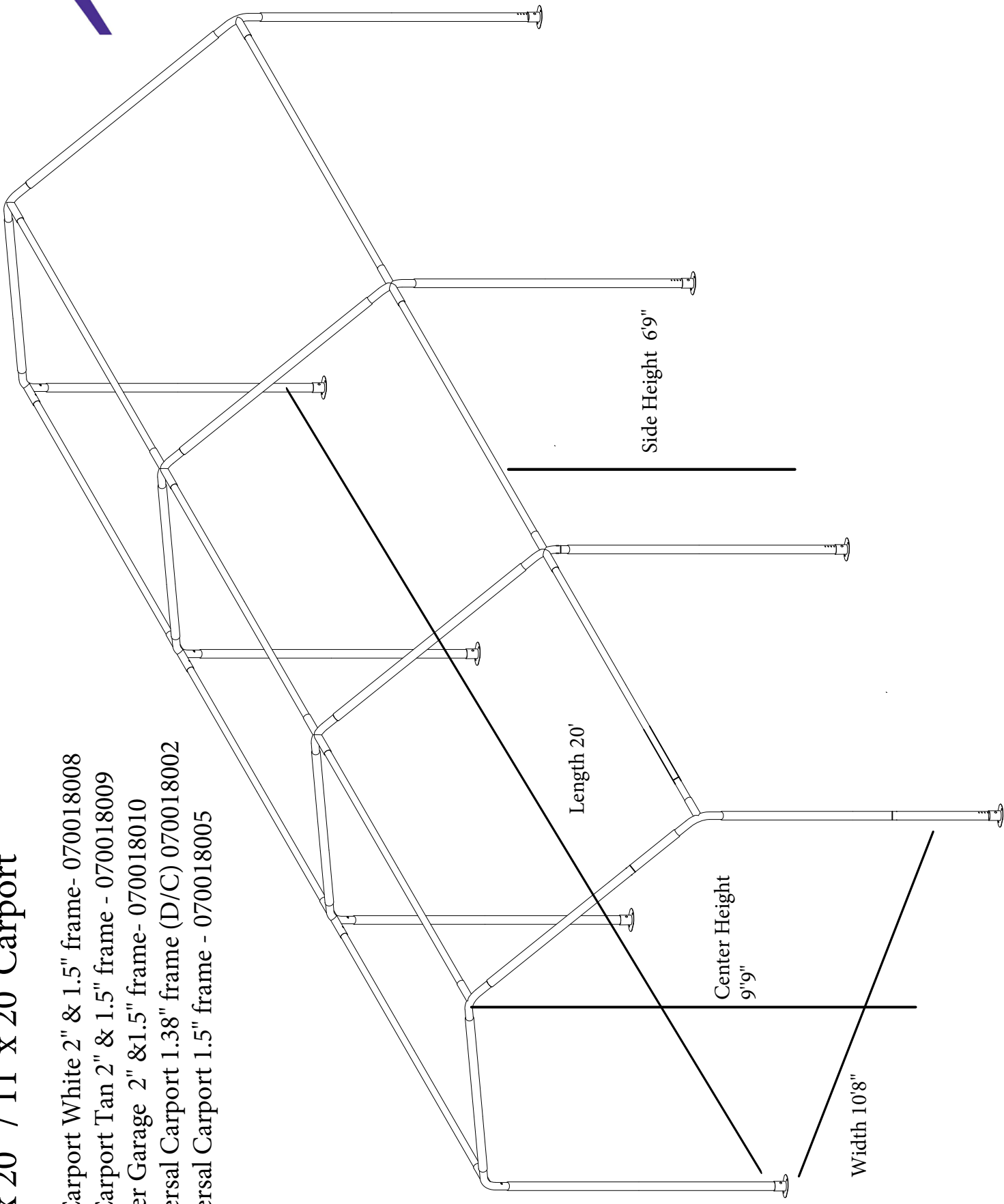

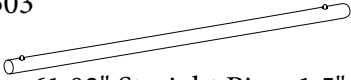
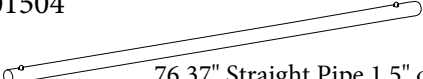
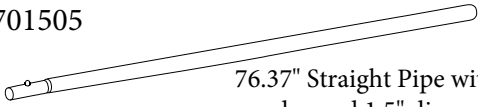
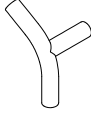
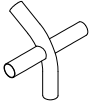

**GP #**

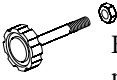
# 10' x 20' / 11' x 20' Carport

- HD Carport White 2" & 1.5" frame- 070018008
- HD Carport Tan 2" & 1.5" frame - 070018009
- Winter Garage 2" & 1.5" frame- 070018010
- Universal Carport 1.38" frame (D/C) 070018002
- Universal Carport 1.5" frame - 070018005

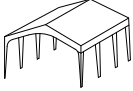

# Party Tent 10.8`X20` -Parts List-

| PART | DESCRIPTION        | ILLUSTRATION  | QUANTITY |
|------|--------------------|---|----------|
| A    | Incline Bar        | 400701503<br><br>61.02" Straight Pipe 1.5" diameter                 | 8        |
| B    | Horizontal Bar     | 400701504<br><br>76.37" Straight Pipe 1.5" diameter                 | 9        |
| C    | Post               | 400701505<br><br>76.37" Straight Pipe with swedge end 1.5" diameter | 8        |
| D    | 3-Way Corner       |  3 Way fitting for 1.5" diameter pipe                                | 6        |
| E    | 4-Way Corner       |  4 Way fitting for 1.5" diameter pipe                                | 6        |
| F    | Base Plate         |  Metal Foot pad for 1.5" diameter pipe                             | 8        |
| G    | Bolt & Nut         |  Bolt with plastic cap and nut for foot pad                        | 8        |
| H    | Elastic Ball Strap |  Elastic ball bungees white 8"                                     | 54       |
| I    | Wirerope           |  Aircraft Cable with rubber coating                               | 4        |
| J    | Turn Buckle        |  Turn Buckle   | 4        |
| K    | Pull-tab           |  Metal Loop  | 4        |
| L    | Canopy Roof        | 070121120<br> Cover with Leg Skirts                                | 1        |
| M    | End Panel          | 070320012<br> Zippered End wall                                    | 1        |
| N    | End Panel          |  Solid End wall  | 1        |
| O    | Wall panel         | 070320020<br> 20' Wide Sidewall w/ windows                         | 2        |

1

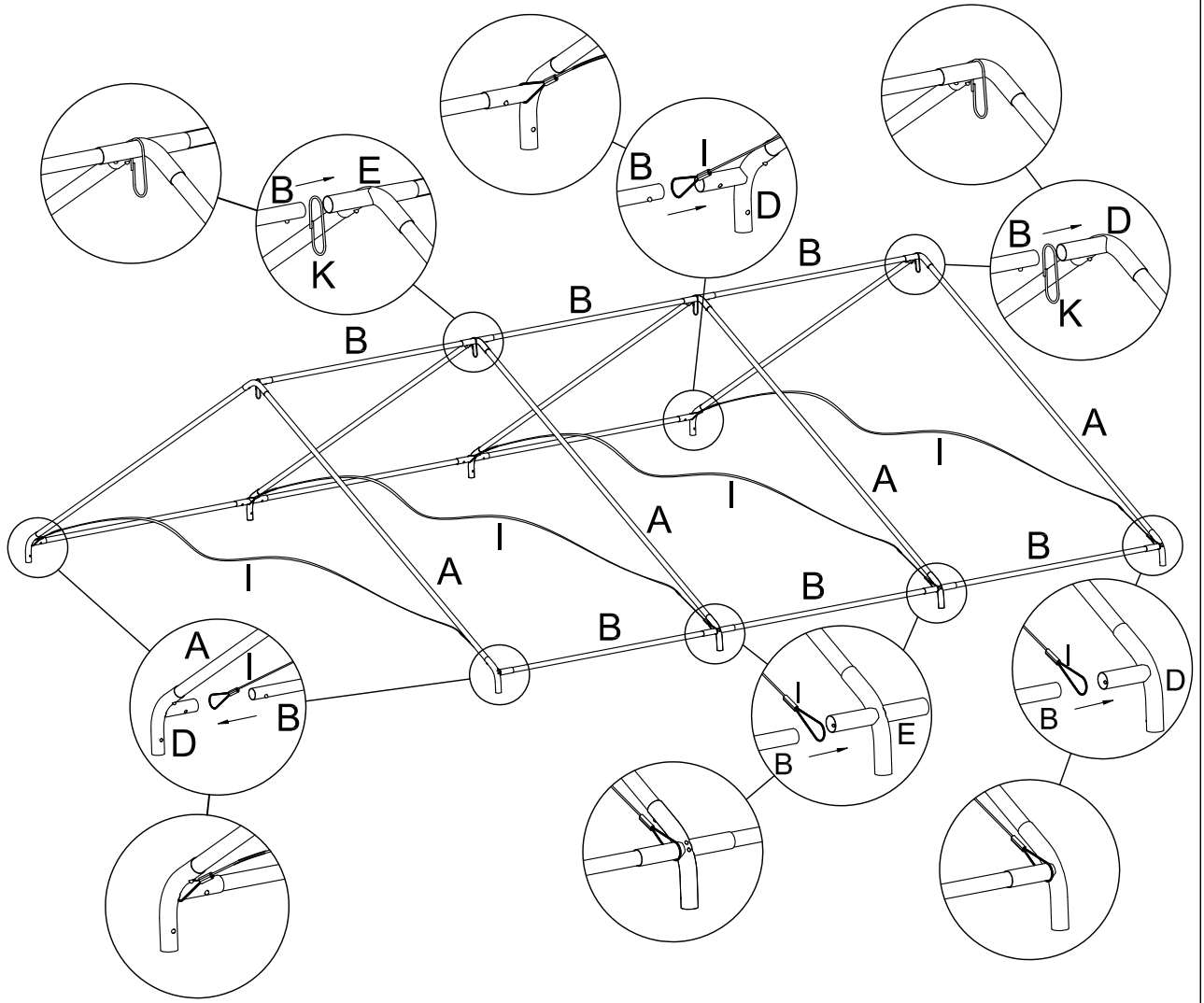

2

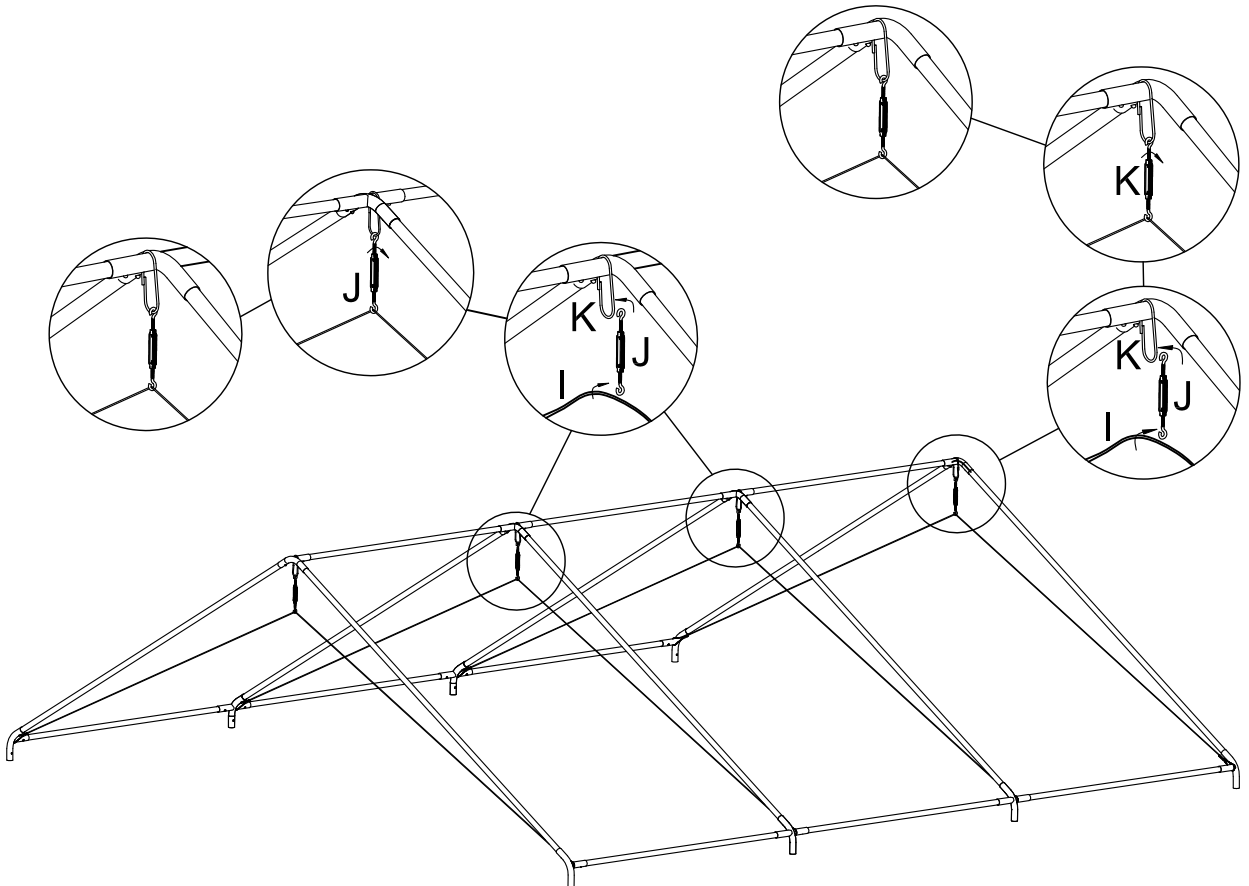

3

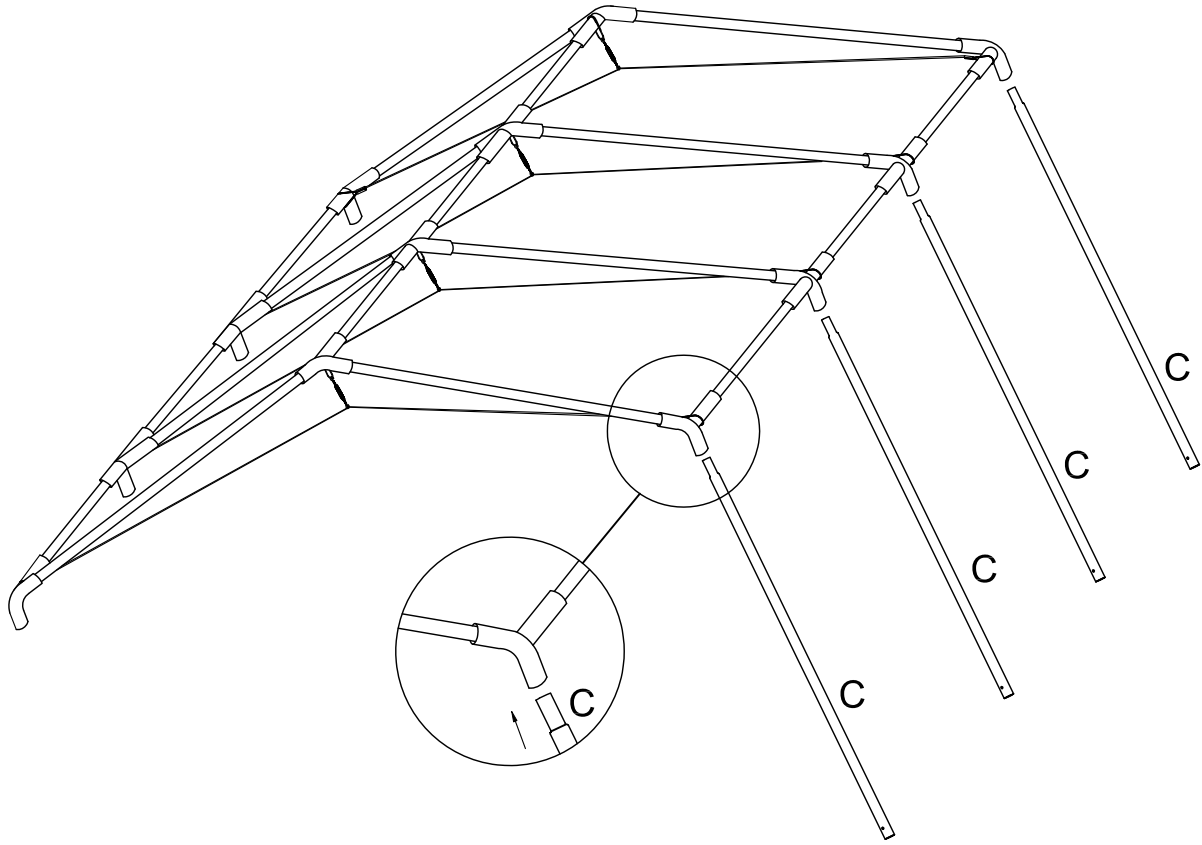

4

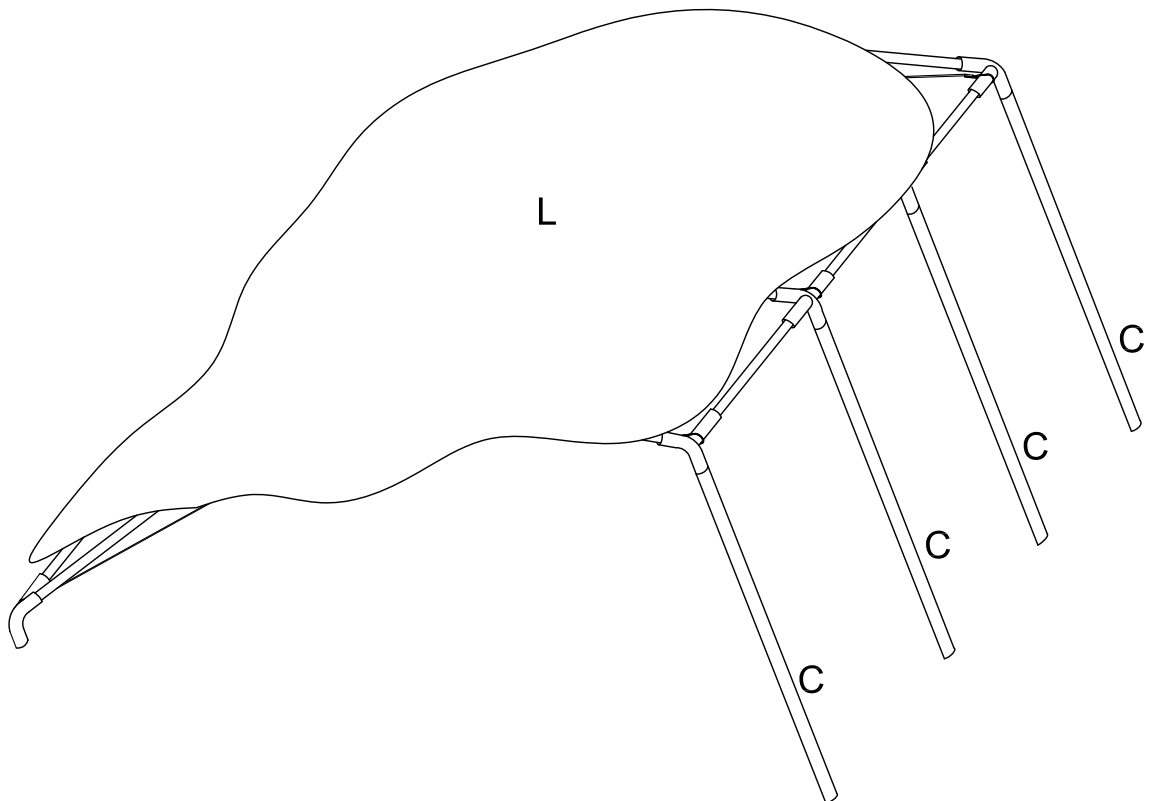

5

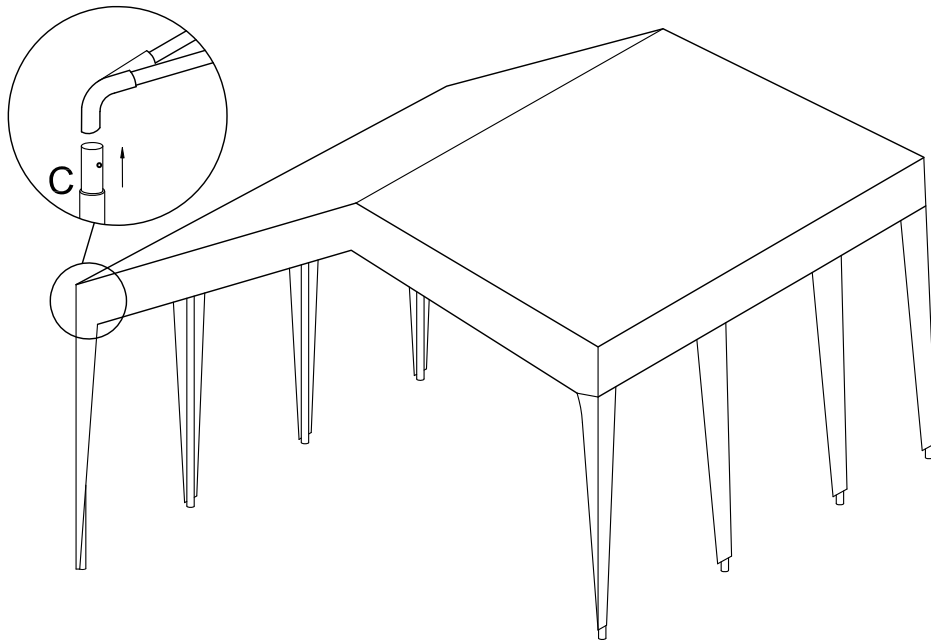

6

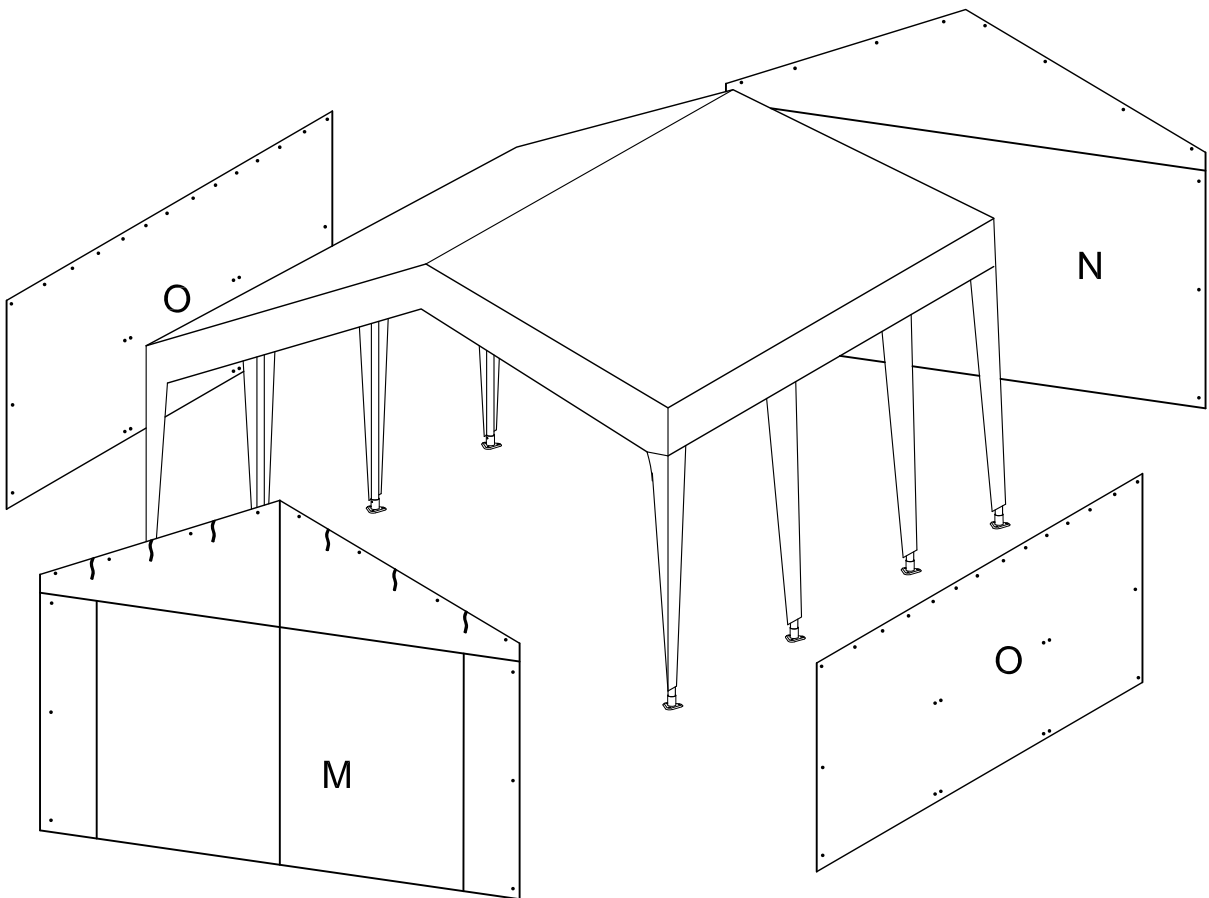

7

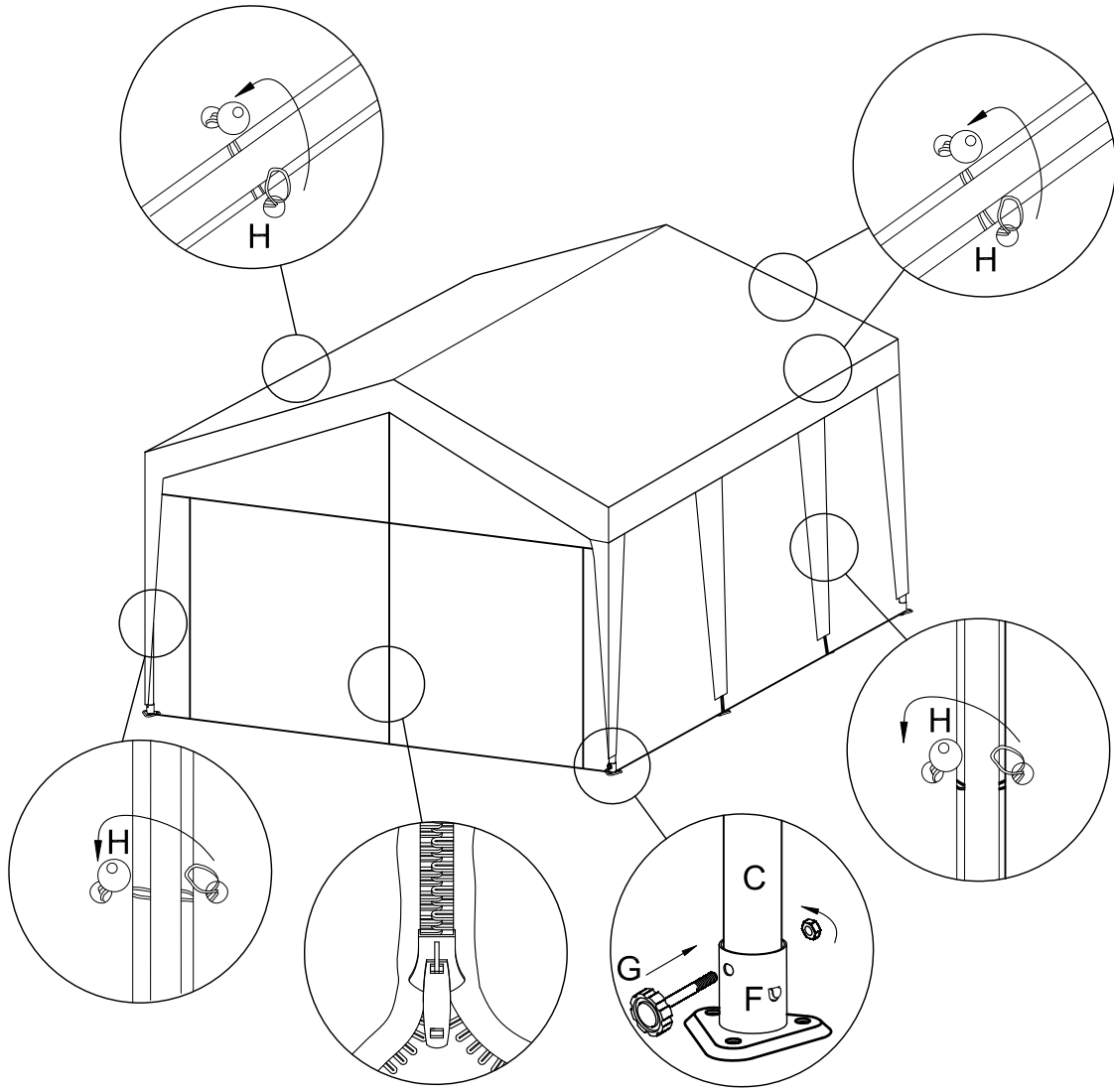

8

