

In-Car Receiver

DSX-B700/DSX-B700W/DSX-B710D



Use this manual if you encounter any problems, or have any questions.

Getting Started

[Guide to Parts and Controls](#)

Resetting the Unit

- [Resetting the Unit](#)

- [Setting the Area/Region \(DSX-B700\(EUR\)\)](#)

- [Setting the Display Language \(DSX-B700\(E\)\)](#)

[Switching the FM/AM Tuning Step \(DSX-B700\(E\)/DSX-B700\(IN\)\)](#)

[Setting the Clock](#)

[Checking the Battery Voltage](#)

Preparing a BLUETOOTH Device

- [Preparing a Bluetooth® Device](#)

- [Pairing and Connecting with a BLUETOOTH Device](#)

- [Connecting with a Paired BLUETOOTH Device](#)

[Connecting with an iPhone/iPod \(BLUETOOTH Auto Pairing\)](#)

[Connecting a USB Device](#)

[Connecting Other Portable Audio Device](#)

Radio

[Listening to the Radio](#)

Using Radio Data System (RDS)

[Setting AF and TA \(DSX-B700\(EUR\)/DSX-B710D\)](#)

[Selecting Program Types \(PTY\)](#)

SiriusXM Radio (DSX-B700(UC))

[Listening to the SiriusXM Radio](#)

[Selecting Channels for SiriusXM](#)

[Selecting Channels from Categories](#)

[Setting a Parental Control](#)

DAB/DAB+ Radio (DSX-B710D)

[Listening to the DAB/DAB+ Radio](#)

Receiving DAB

[Receiving DAB](#)

[Searching for a Station by Station Name](#)

[Searching for a Station by Name \("Quick-BrowZer™"\)](#)

[Searching for a Station by Station Group](#)

[Updating the Station List \(Auto tune\)](#)

[Setting DAB Announcements](#)

[Selecting Program Types \(PTY\)](#)

Playback

[Playing a USB Device](#)

[Playing a BLUETOOTH Device](#)

Searching and Playing Tracks

[Repeat Play and Shuffle Play](#)

[Searching a Track by Name \("Quick-BrowZer"\)](#)

[Searching by Skipping Items \(Jump mode\)](#)

Pandora® (DSX-B700(UC)/DSX-B700W)

[About Pandora®](#)

[Setting up Pandora®](#)

[Streaming Pandora®](#)

Available Operations in Pandora®

[“Thumbs” Feedback](#)

[Using the Station List](#)

[Bookmarking](#)

Handsfree Calling

[Preparing a Mobile Phone](#)

[Receiving a Call](#)

Making a Call

[Making a Call](#)

[Making a Call from the Phonebook](#)

[Making a Call from the Call History](#)

[Making a Call by Phone Number Input](#)

[Making a Call by Redial](#)

[Making a Call by Voice Tags](#)

[Available Operations during Call](#)

Useful Functions

“Sony | Music Center” with iPhone/Android™ Smartphone

[“Sony | Music Center” with iPhone/Android™ Smartphone](#)

[Establishing the “Sony | Music Center” Connection](#)

[Selecting the Source or Application](#)

[Using Voice Recognition \(Android Smartphone Only\)](#)

[Using “Siri Eyes Free”](#)

Settings

[Basic Setting Operation](#)

[General Setup \(GENERAL\)](#)

[Sound Setup \(SOUND\)](#)

[Display Setup \(DISPLAY\)](#)

[BLUETOOTH Setup \(BLUETOOTH\)](#)

[“Sony | Music Center” Setup \(SONY APP\)](#)

Additional Information

[Canceling the Demonstration Mode](#)

[Updating the Firmware](#)

[Precautions](#)

[Maintenance](#)

[Specifications](#)

[Copyrights](#)

Troubleshooting

[Troubleshooting](#)

General

- [No power is being supplied to the unit. \(DSX-B700\(UC\)/DSX-B700\(E\)/DSX-B700\(IN\)/DSX-B700W\).](#)
- [No sound or the sound is very low.](#)
- [No beep sound.](#)
- [The contents of the memory have been erased.](#)
- [Preset stations and correct time are erased. / The fuse has blown. / Makes a noise when the position of the ignition is switched.](#)
- [During playback or reception, the demonstration mode starts.](#)
- [The display disappears from/does not appear in the display window.](#)
- [The display disappears while the unit is operating. \(DSX-B700\(E\)/DSX-B700\(IN\)\).](#)
- [The display/illumination flashes.](#)
- [The operation buttons do not function.](#)
- [The clock set automatically is not accurate.](#)

Radio

- [The radio reception is poor. / Static noise occurs.](#)
- [The stations cannot be received.](#)

[Preset tuning is not possible.](#)

[65 MHz to 74 MHz in FM3 cannot be tuned in. \(DSX-B700\(EUR\)\).](#)

RDS

[PTY displays \[- - - - -\].](#)

[RDS services cannot be received \(when \[AREA\] is set to \[RUSSIA\]\). \(DSX-B700\(EUR\)\).](#)

[The SEEK starts after a few seconds of listening. \(DSX-B700\(EUR\)/DSX-B710D\).](#)

[No traffic announcements. \(DSX-B700\(EUR\)/DSX-B710D\).](#)

[Program service name flashes. \(DSX-B700\(EUR\)/DSX-B710D\).](#)

DAB/DAB+ Radio reception (DSX-B710D)

[DAB stations cannot be received.](#)

[No traffic announcements.](#)

USB playback

[You cannot play items via a USB hub.](#)

[A USB device takes longer to play.](#)

[The sound is intermittent.](#)

[The audio file cannot be played.](#)

[Operations for skipping an album, skipping items \(Jump mode\), and searching a track by name \("Quick-BrowZer"\) cannot be performed.](#)

[The sound cannot be output during playback in Android mode.](#)

BLUETOOTH

[The connecting device cannot detect this unit.](#)

[Connection is not possible.](#)

[The name of the detected device does not appear.](#)

[No ringtone.](#)

[The talker's voice cannot be heard.](#)

[A call partner says that the volume is too low or high.](#)

[Echo or noise occurs in phone call conversations.](#)

[The phone is not connected.](#)

[The phone sound quality is poor.](#)

[The volume of the connected audio device is low \(high\).](#)

[The sound skips during playback of a BLUETOOTH audio device.](#)

- [The connected BLUETOOTH audio device cannot be controlled.](#)
- [Some functions do not work.](#)
- [A call is answered unintentionally.](#)
- [Pairing failed due to a timeout.](#)
- [Cannot pair.](#)
- [BLUETOOTH function cannot operate.](#)
- [No sound is output from the car speakers during handsfree call.](#)
- [“Siri Eyes Free” is not activated.](#)

“Sony | Music Center” operation

- [Application name is mismatched with the actual application in “Sony | Music Center”.](#)
- [While running the “Sony | Music Center” application via BLUETOOTH, the display automatically switches to \[BT AUDIO\].](#)
- [The “Sony | Music Center” application is automatically disconnected when the display switches to \[IPOD\].](#)
- [The “Sony | Music Center” connection is automatically disconnected when the USB mode of the unit is changed to \[ANDROID\].](#)

Pandora® operation (DSX-B700(UC)/DSX-B700W)

- [Pandora® connection is not possible.](#)

Messages

- [General](#)
- [USB Device Playback](#)
- [RDS Operation \(DSX-B700\(EUR\)/DSX-B710D\)](#)
- [DAB/DAB+ Radio Reception \(DSX-B710D\)](#)
- [BLUETOOTH Function](#)
- [“Sony | Music Center” Operation](#)
- [Pandora® Operation \(DSX-B700\(UC\)/DSX-B700W\)](#)
- [SiriusXM Operation \(DSX-B700\(UC\)\)](#)
- [Steering Wheel Remote Control Operation](#)
- [Firmware Update Operation](#)

[Customer Support Websites](#)

[About the “Support by Sony” App](#)

In-Car Receiver
DSX-B700/DSX-B700W/DSX-B710D

Guide to Parts and Controls

Main unit

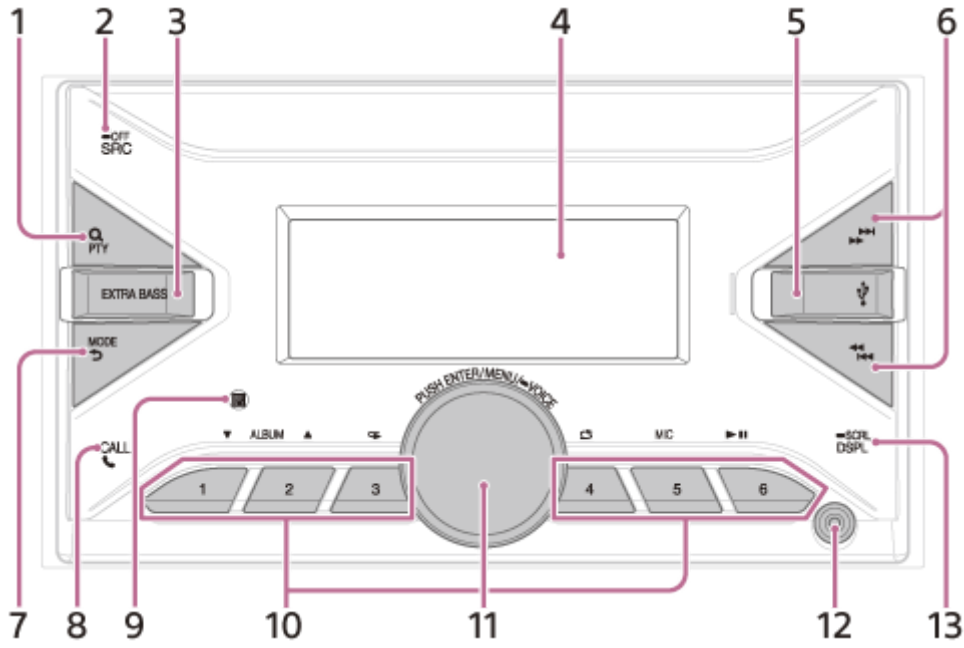

Remote commander (DSX-B700(UC)/DSX-B700(E)/DSX-B700(IN)/DSX-B700W)

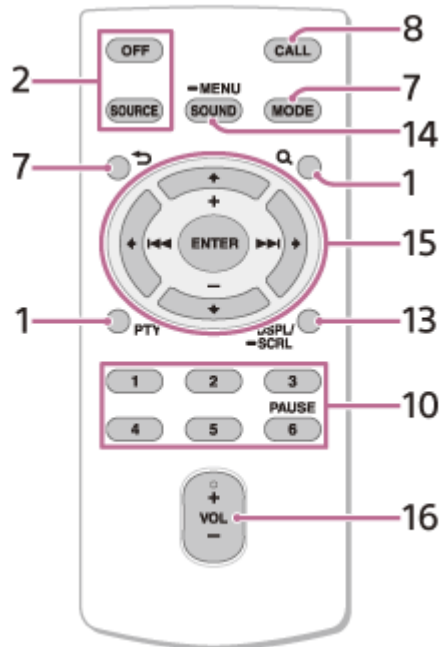

The VOL (volume) + button has a tactile dot.

Remove the insulation film before use.



1. **Q** (browse)
During playback:
Enters the browse mode.
(Not available when a USB device in Android mode or iPod is connected.)
During DAB reception (DSX-B710D):
Enters the browse mode.
PTY (program type)
During FM reception:
Selects PTY in RDS.
During DAB reception (DSX-B710D):
Press twice within 2 seconds to select PTY.
Press and hold for more than 2 seconds to perform an auto tune to update the station list.
2. SRC (source)
Turns on the power.
Changes the source.
OFF
Press and hold for 1 second to turn the source off and display the clock.
Press and hold for more than 2 seconds to turn off the power and the display.
If the unit is turned off and the display disappears, operation by the remote commander is not available (DSX-B700(UC)/DSX-B700(E)/DSX-B700(IN)/DSX-B700(W)).
3. EXTRA BASS
Reinforces bass sound in synchronization with the volume level. Press to change the EXTRA BASS setting: [1], [2], [OFF].
4. Display window
5. USB port
6. **⏮ / ⏭** (SEEK -/+)
During radio reception:
Tunes in radio stations automatically. Press and hold to tune manually.
During DAB reception (DSX-B710D):
Selects a station. Press and hold to search for a station group.
(Available only when [SEEK BY] is set to [STATION GP].)
⏮ / ⏭ (previous/next)
⏪ / ⏩ (fast-reverse/fast-forward)
7. MODE
↶ (back)
Returns to the previous display.
8. CALL **☎**
Enters the call menu. Receives/ends a call.
Press and hold for more than 2 seconds to switch the BLUETOOTH signal.
9. Receptor for the remote commander
10. Number buttons (1 to 6)
Receives preset radio stations. Press and hold to preset stations.
During DAB reception (DSX-B710D):
Receives preset DAB stations or radio stations.
Press and hold to preset DAB stations or radio stations.
ALBUM **▼ / ▲**
Skips an album for audio device. Press and hold to skip albums continuously.
(Not available when a USB device in Android mode or iPod is connected.)
Press **▲** to thumbs up, or **▼** to thumbs down in Pandora® (DSX-B700(UC)/DSX-B700(W)).
↶ (repeat)
(Not available when a USB device in Android mode is connected.)
↻ (shuffle)
(Not available when a USB device in Android mode is connected.)

MIC (microphone)

▶|| (play/pause)

11. Control dial

Adjusts the volume.

PUSH ENTER

Enters the selected item.

Press SRC (source), rotate then press to change the source (timeout in 2 seconds).

MENU

Opens the setup menu.

● VOICE

Press and hold for more than 2 seconds to activate voice dial, voice recognition (Android smartphone only), or the Siri function (iPhone only).

12. AUX input jack

13. DSPL (display)

Changes display items.

● SCRL (scroll)

Press and hold to scroll a display item.

14. SOUND

Opens the SOUND menu directly.

● MENU

Press and hold to open the setup menu.

15. ◀ / ▲ / ▼ / ▶ (left/up/down/right)

Selects a setup item, etc.

ENTER

Enters the selected item.

Press and hold for more than 2 seconds to establish or terminate the “Sony | Music Center” function.

◀◀ / ▶▶ (previous/next)

+/- (album +/-)

16. VOL (volume) +/-

In-Car Receiver

DSX-B700/DSX-B700W/DSX-B710D

Resetting the Unit

Before operating the unit for the first time, after replacing the car battery, or changing the connections, you must reset the unit.

- 1 Press and hold DSPL (display) and CALL  for more than 2 seconds.**

Note

- Resetting the unit will erase the clock setting and some stored contents.

In-Car Receiver

DSX-B700/DSX-B700W/DSX-B710D

Setting the Area/Region (DSX-B700(EUR))

After resetting the unit, the area/region setting display appears.

1 Press ENTER while [AREA] is displayed.

The area/region currently set appears.

2 Rotate the control dial to select [EUROPE] or [RUSSIA], then press it.

3 Rotate the control dial to select [YES] or [NO], then press it.

If the setting area/region is changed, the unit is reset, then the clock is displayed.

This setting can be configured in the general setup menu.

Related Topic

- [General Setup \(GENERAL\)](#)

In-Car Receiver

DSX-B700/DSX-B700W/DSX-B710D

Setting the Display Language (DSX-B700(E))

After resetting the unit, the display language setting display appears.

1 Press ENTER while [LANGUAGE] is displayed.

The display language currently set appears.

2 Rotate the control dial to select [ENGLISH] or [SPANISH], then press it.

The setting is complete and the clock is displayed.

This setting can be configured in the general setup menu.

Related Topic

- [General Setup \(GENERAL\)](#)

In-Car Receiver

DSX-B700/DSX-B700W/DSX-B710D

Switching the FM/AM Tuning Step (DSX-B700(E)/DSX-B700(IN))

Set the FM/AM tuning step of your country. This setting appears **only while the source is off and the clock is displayed**.

- 1** Press MENU, rotate the control dial to select [GENERAL], then press it.
- 2** Rotate the control dial to select [TUNER STEP], then press it.
- 3** Rotate the control dial to select from [50K/9K], [100K/10K] or [200K/10K], then press it.

Setting the Clock

- 1 Press MENU, rotate the control dial to select [GENERAL], then press it.**
- 2 Rotate the control dial to select [CLOCK], then press it.**
- 3 Rotate the control dial to select [MANUAL], then press it.**
The hour indication flashes.
- 4 Rotate the control dial to set the hour and minute.**
To move the digital indication, press **◀◀ / ▶▶** (SEEK -/+).
- 5 After setting the minute, press MENU.**
The setup is complete and the clock starts.

To display the clock

Press DSPL (display).

To set the clock automatically

Select [AUTO <RDS>] in step 3.

For DSX-B710D:

Select [AUTO <DAB>] in step 3.

In-Car Receiver

DSX-B700/DSX-B700W/DSX-B710D

Checking the Battery Voltage

You can check the current battery voltage. (Not available while the source is off and the clock is displayed.)

- 1 Press DSPL (display) repeatedly until the battery voltage display appears.**

In-Car Receiver
DSX-B700/DSX-B700W/DSX-B710D

Preparing a Bluetooth® Device

You can enjoy music, or perform handsfree calling depending on the BLUETOOTH compatible device such as a smartphone, mobile phone and audio device (hereafter “BLUETOOTH device” if not otherwise specified). For details on connecting, refer to the operating instructions supplied with the device. Before connecting the device, turn down the volume of this unit; otherwise, loud sound may result.

In-Car Receiver
DSX-B700/DSX-B700W/DSX-B710D

Pairing and Connecting with a BLUETOOTH Device

When connecting a BLUETOOTH device for the first time, mutual registration (called “pairing”) is required. Pairing enables this unit and other devices to recognize each other. This unit can connect two BLUETOOTH devices (two mobile phones, or a mobile phone and an audio device).



- 1 Place the BLUETOOTH device within 1 m (3 ft) of this unit.**
- 2 Press MENU, rotate the control dial to select [BLUETOOTH], then press it.**
- 3 Rotate the control dial to select [PAIRING], then press it.**
- 4 Rotate the control dial to select [DEVICE 1]* or [DEVICE 2]*, then press it.**
Ⓜ (BLUETOOTH) flashes while the unit is in pairing standby mode.
* [DEVICE 1] or [DEVICE 2] will be changed to the paired device name after pairing is complete.
- 5 Perform pairing on the BLUETOOTH device so it detects this unit.**
- 6 Select your model name shown in the display of the BLUETOOTH device.**
Repeat from step 2 if your model name does not appear.
- 7 If passkey* input is required on the BLUETOOTH device, input [0000].**
When pairing is made, Ⓜ (BLUETOOTH) stays lit.
* Passkey may be called “Passcode”, “PIN code”, “PIN number” or “Password”, etc., depending on the device.
- 8 Select this unit on the BLUETOOTH device to establish the BLUETOOTH connection.**
📱 (mobile phone) or 🎧 (audio) lights up when the connection is made.

Note

- While connecting to a BLUETOOTH device, this unit cannot be detected from another device. To enable detection, enter the pairing mode and search for this unit from another device.

To start playback

Press SRC (source) to select [BT AUDIO].

To disconnect the paired device

Perform steps 2 to 4 to disconnect after this unit and the BLUETOOTH device are paired.

Related Topic

- [Playing a BLUETOOTH Device](#)

5-004-923-11(4) Copyright 2019 Sony Corporation

In-Car Receiver
DSX-B700/DSX-B700W/DSX-B710D

Connecting with a Paired BLUETOOTH Device

To use a paired device, connection with this unit is required. Some paired devices will connect automatically.





1 Press **MENU**, rotate the control dial to select **[BLUETOOTH]**, then press it.



2 Rotate the control dial to select **[BT SIGNAL]**, then press it.

Make sure that  (BLUETOOTH) lights up.

3 Activate the **BLUETOOTH** function on the **BLUETOOTH** device.

4 Operate the **BLUETOOTH** device to connect to this unit.

 (mobile phone) or  (audio) lights up.

Icon in the display	Detail
 (mobile phone)	Lights up when handsfree calling is available by enabling the HFP (Handsfree Profile).
 (audio)	Lights up when the audio device is playable by enabling the A2DP (Advanced Audio Distribution Profile).

To connect the last-connected device from this unit

Activate the BLUETOOTH function on the BLUETOOTH device.

To connect with the audio device, press **SRC** (source) to select **[BT AUDIO]** and press  (play/pause).

To connect with the mobile phone, press **CALL** (only available when there is no audio device or mobile phone connected to the unit).

Hint

- With BLUETOOTH signal on: when the ignition is turned to on, this unit reconnects automatically to the last-connected mobile phone.

Note

- While streaming BLUETOOTH audio, you cannot connect from this unit to the mobile phone. Connect from the mobile phone to this unit instead.

To capture your voice during handsfree calling

You need to install the microphone (supplied).

5-004-923-11(4) Copyright 2019 Sony Corporation

In-Car Receiver
DSX-B700/DSX-B700W/DSX-B710D

Connecting with an iPhone/iPod (BLUETOOTH Auto Pairing)

When an iPhone/iPod with iOS5 or later installed is connected to the USB port, the unit is paired and connected with the iPhone/iPod automatically. To enable BLUETOOTH Auto Pairing, make sure [AUTO PAIR] in [BLUETOOTH] is set to [ON].

1 Activate the BLUETOOTH function on the iPhone/iPod.

2 Connect the iPhone/iPod to the USB port.

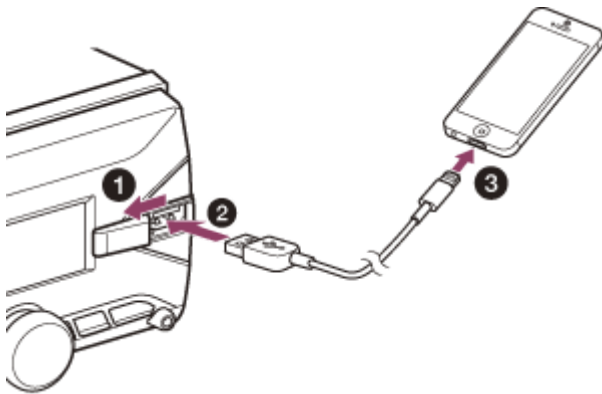

Make sure that  (BLUETOOTH) lights up on the display of the unit.

Note

- BLUETOOTH Auto Pairing is not possible if the unit is already connected to two BLUETOOTH devices. In this case, disconnect one of the devices, then connect the iPhone/iPod again.
- If BLUETOOTH Auto Pairing is not established, perform pairing and make the BLUETOOTH connection with the iPhone/iPod, as with other BLUETOOTH device.

Related Topic

- [BLUETOOTH Setup \(BLUETOOTH\)](#)
- [Preparing a Bluetooth® Device](#)
- [Pairing and Connecting with a BLUETOOTH Device](#)
- [Connecting with a Paired BLUETOOTH Device](#)

In-Car Receiver

DSX-B700/DSX-B700W/DSX-B710D

Connecting a USB Device

1 Turn down the volume on the unit.

2 Connect the **USB** device to the unit.

To connect an iPod/iPhone, use the USB connection cable for iPod (not supplied).

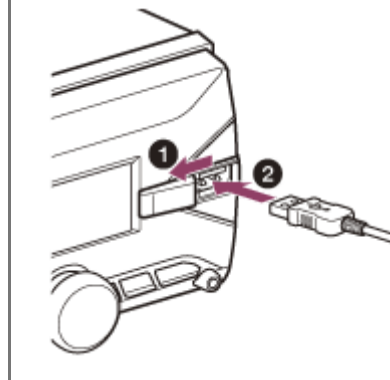

In-Car Receiver
DSX-B700/DSX-B700W/DSX-B710D

Connecting Other Portable Audio Device

- 1 Turn off the portable audio device.
- 2 Turn down the volume on the unit.
- 3 Connect the portable audio device to the AUX input jack (stereo mini jack) on the unit with a connecting cord (not supplied)*.

* Be sure to use a straight type plug.

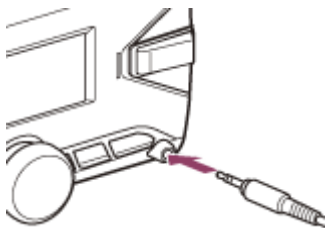

- 4 Press SRC (source) to select [AUX].

To match the volume level of the connected device to other sources

Start playback of the portable audio device at a moderate volume, and set your usual listening volume on the unit. Press MENU, then select [SOUND] → [AUX VOLUME].

Related Topic

- [Sound Setup \(SOUND\)](#)

In-Car Receiver

DSX-B700/DSX-B700W/DSX-B710D

Listening to the Radio

Make sure that the tuning step is properly set according to your area/region (DSX-B700(E)/DSX-B700(IN)). Press SRC (source) to select [RADIO].

To preset stations automatically (BTM)

1. Press MODE to change the band*.
2. Press MENU, rotate the control dial to select [GENERAL], then press it.
3. Rotate the control dial to select [BTM], then press it.

The unit presets stations in order of frequency on the number buttons.

* The following bands can be selected:

DSX-B700(UC)/DSX-B700(E)/DSX-B700(IN)/DSX-B700W: FM1, FM2, FM3, AM1, AM2.

DSX-B700(EUR)/DSX-B710D: FM1, FM2, FM3, AM/LW.

To tune to a station

1. Press MODE to change the band*.
2. Perform tuning.

To tune manually

Press and hold **◀◀ / ▶▶** (SEEK -/+) to locate the approximate frequency, then press **◀◀ / ▶▶** (SEEK -/+) repeatedly to finely adjust to the desired frequency.

To tune automatically

Press **◀◀ / ▶▶** (SEEK -/+).

Scanning stops when the unit receives a station.

* The following bands can be selected:

DSX-B700(UC)/DSX-B700(E)/DSX-B700(IN)/DSX-B700W: FM1, FM2, FM3, AM1, AM2.

DSX-B700(EUR)/DSX-B710D: FM1, FM2, FM3, AM/LW.

To preset a station

While receiving the station that you want to preset, press and hold a number button (1 to 6) until [MEMORY] appears.

To receive preset stations

Select the band, then press a number button (1 to 6).

Related Topic

- [Switching the FM/AM Tuning Step \(DSX-B700\(E\)/DSX-B700\(IN\)\)](#)
- [General Setup \(GENERAL\)](#)

In-Car Receiver

DSX-B700/DSX-B700W/DSX-B710D

Setting AF and TA (DSX-B700(EUR)/DSX-B710D)

Alternative Frequencies (AF) continuously retune the station to the strongest signal in a network, and Traffic Announcement (TA) provides current traffic information or traffic programs (TP) if received.

- 1 Press MENU, rotate the control dial to select [GENERAL], then press it.
- 2 Rotate the control dial to select [AF/TA], then press it.
- 3 Rotate the control dial to select [AF-ON], [TA-ON], [AF/TA-ON] or [AF/TA-OFF], then press it.

To preset RDS stations with the AF and TA setting

You can preset RDS stations along with an AF/TA setting. Set AF/TA, then preset the station with BTM or manually. If you preset manually, you can also preset non-RDS stations.

To receive emergency announcements

With AF or TA on, emergency announcements will automatically interrupt the currently selected source.

To adjust the volume level during a traffic announcement

Level will be stored into memory for subsequent traffic announcements, independently from the regular volume level.

To stay with one regional program (REGIONAL)

When the AF and REGIONAL functions are on, you will not be switched to another regional station with a stronger frequency. If you leave this regional program's reception area, set [REGIONAL] in [GENERAL] to [REG-OFF] during FM reception.

(This function does not work in the UK and some other areas.)

Local Link function (UK only)

This function enables you to select other local stations in the area, even if they are not preset on your number buttons. During FM reception, press a number button (1 to 6) on which a local station is preset. Within 5 seconds, press again a number button of the local station. Repeat this procedure until the local station is received.

Related Topic

- [General Setup \(GENERAL\)](#)

In-Car Receiver
DSX-B700/DSX-B700W/DSX-B710D

Selecting Program Types (PTY)

- 1 Press PTY during FM reception.
- 2 Rotate the control dial to select [PTY MUSIC] or [PTY TALK], then press it.
The unit starts to search for a station broadcasting the selected program type.

Type of programs

DSX-B700(E)/DSX-B700(IN)/DSX-B700(EUR)/DSX-B710D:

PTY TALK	NEWS (News), AFFAIRS (Current Affairs), INFO (Information), SPORT (Sport), EDUCATE (Education), DRAMA (Drama), CULTURE (Culture), SCIENCE (Science), VARIOUS (Varied), WEATHER (Weather), FINANCE (Finance), CHILDREN (Children's Programmes), SOCIAL (Social Affairs), RELIGION (Religion), PHONE IN (Phone In), TRAVEL (Travel), LEISURE (Leisure), DOCUMENT (Documentary)
PTY MUSIC	POP M (Pop Music), ROCK M (Rock Music), EASY M (Easy Listening Music), LIGHT M (Light Classical Music), CLASSICS (Serious Classical Music), OTHER M (Other Music), JAZZ (Jazz Music), COUNTRY (Country Music), NATION M (National Music), OLDIES (Oldies Music), FOLK M (Folk Music)

DSX-B700(UC)/DSX-B700W:

PTY TALK	NEWS (News), INFORM (Information), SPORTS (Sports), TALK (Talk), LANGUAGE (Foreign Language), REL TALK (Religious Talk), PERSONLTY (Personality), PUBLIC (Public), COLLEGE (College), HABL ESP (Spanish Talk), WEATHER (Weather)
PTY MUSIC	ROCK (Rock), CLS ROCK (Classic Rock), ADLT HIT (Adult Hits), SOFT RCK (Soft Rock), TOP 40 (Top 40), COUNTRY (Country), OLDIES (Oldies), SOFT (Soft), NOSTALGA (Nostalgia), JAZZ (Jazz), CLASSICL (Classical), R & B (Rhythm and Blues), SOFT R&B (Soft Rhythm and Blues), REL MUSC (Religious Music), MUSC ESP (Spanish Music), HIP HOP (Hip-Hop)

In-Car Receiver

DSX-B700/DSX-B700W/DSX-B710D

Listening to the SiriusXM Radio

To activate your SiriusXM Subscription

Only SiriusXM brings you more of what you love to listen to, all in one place. Get over 140 channels, including commercial-free music plus the best sports, news, talk, comedy and entertainment. Welcome to the world of satellite radio. A SiriusXM Connect Vehicle Tuner and Subscription are required. For more information, visit www.siriusxm.com

After installing your SiriusXM Connect Vehicle Tuner and antenna (aerial), press SRC (source) to select [SIRIUS XM]. You should be able to hear the SiriusXM preview channel on Channel 1. After verifying that you can hear the preview channel, select Channel 0 to find the Radio ID of your tuner. In addition, the Radio ID is located on the bottom of the SiriusXM Connect Vehicle Tuner and its packaging. You will need this number to activate your subscription. Write the number down for reference.

Note

- The SiriusXM Radio ID does not include the letters I, O, S or F.

In the USA, you can activate online or by calling SiriusXM Listener Care:

- Online: Visit www.siriusxm.com/activatenow
- Phone: Call 1-866-635-2349

In Canada, you can activate online or by calling SiriusXM Listener Care:

- Online: Visit www.siriusxm.ca/activatexm
- Phone: Call 1-877-438-9677

As part of the activation process, the SiriusXM satellites will send an activation message to your tuner. When your radio detects that the tuner has received the activation message, your radio will display: [SUBSCRIP UPDATED - PRESS ENTER TO CONTINUE]. Once subscribed, you can tune to channels in your subscription plan.

Note

- The activation process usually takes 10 to 15 minutes, but may take up to an hour.
- Your radio will need to be turned on and receiving the SiriusXM signal to receive the activation message.

In-Car Receiver

DSX-B700/DSX-B700W/DSX-B710D

Selecting Channels for SiriusXM

- 1 Press **Q** (browse).
- 2 Rotate the control dial to select [CHANNEL], then press it.
- 3 Rotate the control dial to select the desired channel, then press it.

To select channels with rapid browse mode

Press and hold **↑** (up) or **↓** (down) of remote commander for more than 2 seconds after [CHANNEL] selected, then press ENTER.

In-Car Receiver

DSX-B700/DSX-B700W/DSX-B710D

Selecting Channels from Categories

- 1 Press **Q** (browse).
- 2 Rotate the control dial to select [CATEGORY], then press it.
- 3 Rotate the control dial to select the desired category, then press it.
The channel list appears.
- 4 Rotate the control dial to select the desired channel, then press it.

To preset channels

While receiving the channel that you want to preset, press and hold a number button (1 to 6) until [MEMORY] appears.

To receive the preset channel, press MODE to select the Band you want ([SXM1], [SXM2] or [SXM3]), then press a number button (1 to 6). (Each Band can preset up to 6 channels.)

Setting a Parental Control

The parental control feature allows you to limit the access to SiriusXM channels with mature content. When enabled, the parental control feature requires you to enter a passcode to tune to the locked channels. Information on setting up the passcode and locking channels can be found below.

- 1 Press **MENU** and rotate the control dial.
- 2 Select **[GENERAL]** → **[PARENTAL]** → **[LOCK SELECT]** → **[LOCK-ON]**.
- 3 Enter the passcode by rotating the control dial on the unit or pressing **↑ / ↓** (up/down) on the remote commander.

To move the entry position, press **◀◀ / ▶▶** (SEEK -/+) on the unit or **← / →** (left/right) on the remote commander.
The initial passcode is [0000].
- 4 After entering the passcode, press **ENTER**.

To unlock the channels

1. Press **MENU** and rotate the control dial.
2. Select **[GENERAL]** → **[PARENTAL]** → **[LOCK SELECT]** → **[LOCK-OFF]**.

To change the passcode

1. Press **MENU** and rotate the control dial.
2. Select **[GENERAL]** → **[PARENTAL]** → **[CODE EDIT]**.
3. Enter the current passcode on the current passcode input display, then press **ENTER**.
The initial passcode is [0000].
4. Enter your new 4-digit passcode on the new passcode input display, then press **ENTER**.

To change display items

Press **DSPL** (display) repeatedly until the desired display items appear.

In-Car Receiver

DSX-B700/DSX-B700W/DSX-B710D

Listening to the DAB/DAB+ Radio

Press SRC (source) to select [DAB/DAB+]. When the DAB source is selected for the first time after replacing the car battery or changing the connections, the auto tune starts automatically. Allow the auto tune to finish. (If interrupted, the auto tune will start again the next time you select the DAB source.) If no DAB station is preset by the auto tune, perform an auto tune manually.

Hint

- Set [ANT-PWR] to [ON] (default) or [OFF] depending on the type of DAB antenna (aerial).

Related Topic

- [General Setup \(GENERAL\)](#)

In-Car Receiver

DSX-B700/DSX-B700W/DSX-B710D

Receiving DAB

DAB (Digital Audio Broadcasting) is a transmission system on terrestrial networks. DAB stations bundle radio programs (“stations”) into a station group, and each station contains one or more components. The same station can sometimes be received on different frequencies.

In-Car Receiver

DSX-B700/DSX-B700W/DSX-B710D

Searching for a Station by Station Name

Before operation, make sure that [SEEK BY] in [GENERAL] is set to [A-Z].

- 1 Press **MODE** to select [DAB1], [DAB2] or [DAB3].
 - 2 Press **⏮ / ⏭** (SEEK -/+) to switch to the previous/next station.
-

Related Topic

- [General Setup \(GENERAL\)](#)

In-Car Receiver

DSX-B700/DSX-B700W/DSX-B710D

Searching for a Station by Name (“Quick-BrowZer™”)

You can display a list of stations for easy searching.

1 During DAB reception, press **Q** (browse).

The unit enters “Quick-BrowZer” mode, and the list of stations appears.

2 Rotate the control dial to select the desired station, then press it.

Reception starts.

To exit the “Quick-BrowZer” mode

Press  (back).

In-Car Receiver

DSX-B700/DSX-B700W/DSX-B710D

Searching for a Station by Station Group

Before operation, make sure that [SEEK BY] in [GENERAL] is set to [STATION GP].

- 1 Press **MODE** to select [DAB1], [DAB2] or [DAB3].
- 2 Press **◀◀ / ▶▶** (SEEK -/+) to search for a station within a station group; press and hold **◀◀ / ▶▶** (SEEK -/+) to search for different station groups.

Scanning stops when the unit receives a station/station group. Search until the desired station is received.

Related Topic

- [General Setup \(GENERAL\)](#)

In-Car Receiver
DSX-B700/DSX-B700W/DSX-B710D

Updating the Station List (Auto tune)

1 Press MENU, rotate the control dial to select [GENERAL], then press it.

2 Rotate the control dial to select [AUTO TUNE], then press it.

The unit updates the list of stations.

Alternatively, press and hold  (browse) to start the auto tune.

To preset a station

While receiving the station that you want to preset, press and hold a number button (1 to 6) until [MEMORY] appears.

To receive preset stations

After selecting the desired band, press a number button (1 to 6).

In-Car Receiver

DSX-B700/DSX-B700W/DSX-B710D

Setting DAB Announcements

If you enable DAB announcements, DAB announcements can interrupt the currently selected source.

- 1 Press MENU, rotate the control dial to select [GENERAL], then press it.
- 2 Rotate the control dial to select [ANNOUNCE], then press it.
- 3 Rotate the control dial to select [ANNC-ON] or [ANNC-OFF], then press it.

Note

- During a DAB announcement, the volume is adjusted to the level set for TA in RDS.

To listen to the same or similar program even during weak reception

Set [SOFTLINK] to [ON].

[-FM] is added to the end of the FM program name when the corresponding FM program is being received.

“Hard Link” follows the same program, and “Soft Link” follows a similar program.

SOFT LINK	DAB/FM
OFF	Hard Link only
ON	Hard Link/Soft Link

Related Topic

- [Setting AF and TA \(DSX-B700\(EUR\)/DSX-B710D\)](#)
- [General Setup \(GENERAL\)](#)

In-Car Receiver

DSX-B700/DSX-B700W/DSX-B710D

Selecting Program Types (PTY)

Use PTY to display or search for a desired program type.

- 1 Press PTY twice within 2 seconds to select PTY.**
- 2 Rotate the control dial until the desired program type appears, then press it.**

The unit lists all stations in the selected program type.
- 3 Rotate the control dial until the desired station appears, then press it.**

Reception starts.

Type of programs

NEWS (News), AFFAIRS (Current Affairs), INFO (Information), SPORT (Sport), EDUCATE (Education), DRAMA (Drama), ARTS (Culture), SCIENCE (Science), TALK (Varied), POP (Pop Music), ROCK (Rock Music), EASY (Easy Listening Music), CLASSICS (Light Classical Music), CLASSICS (Serious Classical Music), OTHER M (Other Music), WEATHER (Weather), FINANCE (Finance), CHILDREN (Children's Programmes), FACTUAL (Social Affairs), RELIGION (Religion), PHONE IN (Phone In), TRAVEL (Travel), LEISURE (Leisure), JAZZ (Jazz Music), COUNTRY (Country Music), NATION M (National Music), OLDIES (Oldies Music), FOLK (Folk Music), DOCUMENT (Documentary)

In-Car Receiver

DSX-B700/DSX-B700W/DSX-B710D

Playing a USB Device

In these Operating Instructions, “iPod” is used as a general reference for the iPod functions on an iPod and iPhone, unless otherwise specified by the text or illustrations.

For details on the compatibility of your iPod, see “[About iPod](#)” or visit the support site.

AOA (Android Open Accessory) 2.0, MSC (Mass Storage Class) and MTP (Media Transfer Protocol) type USB devices* compliant with the USB standard can be used. Depending on the USB device, the Android mode or MSC/MTP mode can be selected on the unit.

Some digital media players or Android smartphones may require setting to MTP mode.

* e.g., a USB flash drive, digital media player, Android smartphone

Note

- For details on the compatibility of your USB device, visit the support site.
- Smartphones with Android OS 4.1 or higher installed support Android Open Accessory 2.0 (AOA 2.0). However, some smartphones may not fully support AOA 2.0 even if Android OS 4.1 or higher is installed. For details on the compatibility of your Android smartphone, visit the support site.
- Playback of the following files is not supported.
MP3/WMA/AAC/FLAC:
 - copyright-protected files
 - DRM (Digital Rights Management) files
 - Multi-channel audio files
MP3/WMA/AAC:
 - lossless compression files

Before making a connection, select the USB mode (Android mode or MSC/MTP mode) depending on the USB device.

1. Connect a USB device to the USB port.

Playback starts.

If a device is already connected, to start playback, press SRC (source) to select [USB] ([IPOD] appears in the display when the iPod is recognized).

2. Adjust the volume on this unit.

To stop playback

Press and hold OFF for 1 second.

To remove the device

Stop playback, then remove the device.

Caution for iPhone

When you connect an iPhone via USB, phone call volume is controlled by the iPhone, not the unit. Do not inadvertently increase the volume on the unit during a call, as a sudden loud sound may result when the call ends.

Related Topic

- [Precautions](#)
- [Connecting a USB Device](#)
- [General Setup \(GENERAL\)](#)
- [Customer Support Websites](#)

5-004-923-11(4) Copyright 2019 Sony Corporation

In-Car Receiver
DSX-B700/DSX-B700W/DSX-B710D

Playing a BLUETOOTH Device

You can play contents on a connected device that supports BLUETOOTH A2DP (Advanced Audio Distribution Profile).



- 1 **Make BLUETOOTH connection with the audio device.**
See “[Connecting with a Paired BLUETOOTH Device](#)”.

To select the audio device, press MENU, then select [BLUETOOTH] → [AUDIO DEV].

- 2 **Press SRC (source) to select [BT AUDIO].**

- 3 **Operate the audio device to start playback.**

- 4 **Adjust the volume on this unit.**

Note

- Depending on the audio device, information such as title, track number/time and playback status may not be displayed on this unit.
- Even if the source is changed on this unit, playback of the audio device does not stop.
- [BT AUDIO] does not appear in the display while running the “Sony | Music Center” application via the BLUETOOTH function.

To match the volume level of the BLUETOOTH device to other sources

Start playback of the BLUETOOTH audio device at a moderate volume, and set your usual listening volume on the unit. Press MENU, then select [SOUND] → [BTA VOLUME].

Related Topic

- [Connecting with a Paired BLUETOOTH Device](#)
- [Sound Setup \(SOUND\)](#)
- [BLUETOOTH Setup \(BLUETOOTH\)](#)

In-Car Receiver

DSX-B700/DSX-B700W/DSX-B710D

Repeat Play and Shuffle Play

Not available when a USB device in Android mode is connected.

1 During playback, press  (repeat) or  (shuffle) repeatedly to select the desired play mode.

Available play modes differ depending on the selected sound source.

In-Car Receiver

DSX-B700/DSX-B700W/DSX-B710D

Searching a Track by Name (“Quick-BrowZer”)

Not available when a USB device in Android mode or iPod is connected.

1 During USB playback, press **Q** (browse)* to display the list of search categories.

When the track list appears, press **↶** (back) repeatedly to display the desired search category.

* During USB playback, press and hold **Q** (browse) for more than 2 seconds to directly return to the beginning of the category list.

2 Rotate the control dial to select the desired search category, then press it.

3 Rotate the control dial to select the desired track, then press it.

Playback starts.

To exit the “Quick-BrowZer” mode

Press **Q** (browse).

In-Car Receiver

DSX-B700/DSX-B700W/DSX-B710D

Searching by Skipping Items (Jump mode)

Not available when a USB device in Android mode or iPod is connected.

- 1** During USB playback, press **Q** (browse).
- 2** Press **▶▶** (SEEK +).
- 3** Rotate the control dial to select the item.
The list is jumped in steps of 10% of the total number of items.
- 4** Press **ENTER** to return to the “Quick-BrowZer” mode.
The selected item appears.
- 5** Rotate the control dial to select the desired item, then press it.
Playback starts.

In-Car Receiver

DSX-B700/DSX-B700W/DSX-B710D

About Pandora®

Pandora® is available to stream music through your iPhone and Android smartphone. You can control Pandora® on a BLUETOOTH connected iPhone/Android smartphone from this unit.

Pandora® is only available in certain countries.

Please visit

<http://www.pandora.com/legal>

for more information.

In-Car Receiver

DSX-B700/DSX-B700W/DSX-B710D

Setting up Pandora®

- 1 Check the compatibility of your mobile device by visiting the support site.
 - 2 Download the latest version of the Pandora® application from your smartphone's app store. A list of compatible devices can be found at www.pandora.com/everywhere/mobile
-

Related Topic

- [Customer Support Websites](#)

In-Car Receiver

DSX-B700/DSX-B700W/DSX-B710D

Streaming Pandora®

1 Make BLUETOOTH connection with the audio device.

To select the audio device, press MENU, then select [BLUETOOTH] → [AUDIO DEV].

2 Press SRC (source) to select [PANDORA].

3 Launch Pandora® application on your mobile device.

4 Press ►|| (play/pause) to start playback.

If the device number appears

Make sure that the same numbers are displayed (e.g., 123456) in this unit and the mobile device, then press ENTER on this unit and select [Yes] on the mobile device.

When activating the BLUETOOTH function

You can adjust the volume level.

Press MENU, then select [SOUND] → [BTA VOLUME].

Related Topic

- [Connecting with a Paired BLUETOOTH Device](#)
- [Sound Setup \(SOUND\)](#)
- [BLUETOOTH Setup \(BLUETOOTH\)](#)

In-Car Receiver

DSX-B700/DSX-B700W/DSX-B710D

“Thumbs” Feedback

“Thumbs Up” or “Thumbs Down” feedback allows you to personalize stations.

1 During playback, press ▲ (Thumbs Up) or ▼ (Thumbs Down).

In-Car Receiver

DSX-B700/DSX-B700W/DSX-B710D

Using the Station List

The station list allows you to easily select a desired station.

- 1** During playback, press **Q** (browse).
- 2** Press **▶▶** (SEEK +) to select the sorting order [STATION SORT BY DATE] or [STATION SORT BY A TO Z].
- 3** Rotate the control dial to select the desired station, then press it.
Playback starts.

In-Car Receiver

DSX-B700/DSX-B700W/DSX-B710D

Bookmarking

The track currently being played can be bookmarked and stored in your Pandora® account.

- 1 During playback, press MODE.**

5-004-923-11(4) Copyright 2019 Sony Corporation

In-Car Receiver
DSX-B700/DSX-B700W/DSX-B710D

Preparing a Mobile Phone

To use a mobile phone, connect it with this unit. You can connect two mobile phones to the unit.



Related Topic

- [Preparing a Bluetooth® Device](#)

In-Car Receiver

DSX-B700/DSX-B700W/DSX-B710D

Receiving a Call

- 1 Press CALL when a call is received with a ringtone.**

The phone call starts.

Note

- The ringtone and talker's voice are output from the front speakers. To select the speakers for handsfree calling, press MENU, then select [BLUETOOTH] → [VOICE-OUT].

To reject the call

Press and hold OFF for 1 second.

To end the call

Press CALL again.

Related Topic

- [BLUETOOTH Setup \(BLUETOOTH\)](#)

In-Car Receiver
DSX-B700/DSX-B700W/DSX-B710D

Making a Call

You can make a call from the phonebook or call history when a mobile phone supporting PBAP (Phone Book Access Profile) is connected. When two mobile phones are connected to the unit, select either phone.

In-Car Receiver

DSX-B700/DSX-B700W/DSX-B710D

Making a Call from the Phonebook

1 Press CALL.

When two mobile phones are connected to the unit, rotate the control dial to select either phone, then press it.

2 Rotate the control dial to select [PHONE BOOK], then press it.**3 Rotate the control dial to select an initial from the initial list, then press it.****4 Rotate the control dial to select a name from the name list, then press it.****5 Rotate the control dial to select a phone number from the number list, then press it.**

The phone call starts.

In-Car Receiver

DSX-B700/DSX-B700W/DSX-B710D

Making a Call from the Call History

1 Press CALL.

When two mobile phones are connected to the unit, rotate the control dial to select either phone, then press it.

2 Rotate the control dial to select [RECENT CALL], then press it.

A list of the call history appears.

3 Rotate the control dial to select a name or phone number from the call history, then press it.

The phone call starts.

In-Car Receiver

DSX-B700/DSX-B700W/DSX-B710D

Making a Call by Phone Number Input

1 Press CALL.

When two mobile phones are connected to the unit, rotate the control dial to select either phone, then press it.

2 Rotate the control dial to select [DIAL NUMBER], then press it.

3 Rotate the control dial to enter the phone number, and lastly select [] (space), then press ENTER*.

The phone call starts.

* To move the digital indication, press **◀◀ / ▶▶** (SEEK -/+).

Note

- [] appears instead of [#] on the display.

In-Car Receiver

DSX-B700/DSX-B700W/DSX-B710D

Making a Call by Redial

1 Press CALL.

When two mobile phones are connected to the unit, rotate the control dial to select either phone, then press it.

2 Rotate the control dial to select [REDIAL], then press it.

The phone call starts.

In-Car Receiver
DSX-B700/DSX-B700W/DSX-B710D

Making a Call by Voice Tags

You can make a call by saying the voice tag stored in a connected mobile phone that has a voice dialing function.

1 Press CALL.

When two mobile phones are connected to the unit, rotate the control dial to select either phone, then press it.

2 Rotate the control dial to select [VOICE DIAL], then press it.

Alternatively, press and hold VOICE for more than 2 seconds (only available for the first mobile phone connected to the unit).

3 Say the voice tag stored on the mobile phone.

Your voice is recognized, and the phone call starts.

To cancel voice dialing

Press VOICE.

In-Car Receiver
DSX-B700/DSX-B700W/DSX-B710D

Available Operations during Call

To adjust the ringtone volume

Rotate the control dial while receiving a call.

To adjust the talker's voice volume

Rotate the control dial during a call.

To adjust the volume for the other party (Mic gain adjustment)

Press MIC.

Adjustable volume levels: [MIC-LOW], [MIC-MID], [MIC-HI].

To reduce echo and noise (Echo Canceler/Noise Canceler Mode)

Press and hold MIC.

Settable mode: [EC/NC-1], [EC/NC-2].

To switch between handsfree mode and handheld mode

During a call, press MODE to switch the phone call audio between the unit and mobile phone.

Note

- Depending on the mobile phone, this operation may not be available.

In-Car Receiver
DSX-B700/DSX-B700W/DSX-B710D

“Sony | Music Center” with iPhone/Android™ Smartphone

Downloading the latest version of “Sony | Music Center” application is required from the App Store for iPhone or from Google Play for Android smartphone.

Note

- For your safety, follow your local traffic laws and regulations, and do not operate the application while driving.
- “Sony | Music Center” is an app for controlling Sony audio devices which are compatible with “Sony | Music Center”, by your iPhone/Android smartphone.
- What you can control with “Sony | Music Center” varies depending on the connected device.
- To make use of “Sony | Music Center” features, see the details on your iPhone/Android smartphone.
- For further details on “Sony | Music Center”, visit the following URL: <http://www.sony.net/smcqa/>
- Visit the website below and check the compatible iPhone/Android smartphone models.
For iPhone: visit the App Store
For Android smartphone: visit Google Play

In-Car Receiver

DSX-B700/DSX-B700W/DSX-B710D

Establishing the “Sony | Music Center” Connection

1 Make the BLUETOOTH connection with iPhone/Android smartphone.

To select the audio device, press MENU, then select [BLUETOOTH] → [AUDIO DEV].

2 Launch the “Sony | Music Center” application.

3 Press MENU, rotate the control dial to select [SONY APP], then press it.

Connection to iPhone/Android smartphone starts.

For details on the operations on iPhone/Android smartphone, refer to the help of the application.

If the device number appears

Make sure that the number is displayed (e.g., 123456), then select [Yes] on the iPhone/Android smartphone.

To terminate connection

Press MENU, rotate the control dial to select [SONY APP], then press it.

Related Topic

- [BLUETOOTH Setup \(BLUETOOTH\)](#)
- [Connecting with a Paired BLUETOOTH Device](#)

In-Car Receiver
DSX-B700/DSX-B700W/DSX-B710D

Selecting the Source or Application

You can operate to select the desired source or application on iPhone/Android smartphone.

To select the source

Press SRC (source) repeatedly. Alternatively, press SRC (source), rotate the control dial to select the desired source, then press ENTER.

To display the source list

Press SRC (source).

To make sound and display settings

You can adjust the settings relating to sound and display via iPhone/Android smartphone.

For details on settings, refer to the help of the application.

In-Car Receiver
DSX-B700/DSX-B700W/DSX-B710D

Using Voice Recognition (Android Smartphone Only)

- 1 Press and hold VOICE to activate voice recognition.
- 2 Say the desired voice command into the microphone.

To deactivate voice recognition

Press VOICE.

Note

- Voice recognition may not be available in some cases.
- Voice recognition may not work properly depending on the performance of the connected Android smartphone.
- Operate under conditions where noise such as engine sound is minimized during voice recognition.

In-Car Receiver
DSX-B700/DSX-B700W/DSX-B710D

Using “Siri Eyes Free”

“Siri Eyes Free” allows you to use an iPhone handsfree by simply speaking into the microphone. This function requires you to connect an iPhone to the unit via BLUETOOTH. Availability is limited iPhone 4s or later. Make sure that your iPhone is running the latest iOS version. You must complete BLUETOOTH registration and connection configurations for the iPhone with the unit in advance.

To select the iPhone, press MENU, then select [BLUETOOTH] → [AUDIO DEV].

- 1 Activate the Siri function on the iPhone.**
For details, refer to the operating instructions supplied with the iPhone.
- 2 Press and hold VOICE for more than 2 seconds.**
The voice command display appears.
- 3 After the iPhone beeps, speak into the microphone.**
The iPhone beeps again, then Siri starts responding.

To deactivate “Siri Eyes Free”

Press VOICE.

Note

- The iPhone may not recognize your voice depending on usage conditions. (For example, if you are in a moving car.)
- “Siri Eyes Free” may not function properly, or the response time may lag in locations where iPhone signals are difficult to receive.
- Depending on the iPhone’s operating condition, “Siri Eyes Free” may not function properly, or may quit.
- If you play a track with an iPhone using the BLUETOOTH audio connection, when the track starts playback via BLUETOOTH, “Siri Eyes Free” automatically quits and the unit switches to the BLUETOOTH audio source.
- When “Siri Eyes Free” is activated during audio playback, the unit may switch to the BLUETOOTH audio source even if you do not specify a track to play.
- When connecting the iPhone to the USB port, “Siri Eyes Free” may not function properly, or may quit.
- When connecting the iPhone to the unit via USB, do not activate Siri with the iPhone. “Siri Eyes Free” may not function properly, or may quit.
- There is no audio sound while “Siri Eyes Free” is activated.

Related Topic

- [Preparing a Bluetooth® Device](#)
- [BLUETOOTH Setup \(BLUETOOTH\)](#)

In-Car Receiver

DSX-B700/DSX-B700W/DSX-B710D

Basic Setting Operation

You can set items in the following setup categories: General setup (GENERAL), Sound setup (SOUND), Display setup (DISPLAY), BLUETOOTH setup (BLUETOOTH), "Sony | Music Center" setup (SONY APP).

- 1 Press MENU.**
- 2 Rotate the control dial to select the setup category, then press it.**
The items that can be set differ depending on the source and settings.
- 3 Rotate the control dial to select the options, then press it.**

To return to the previous display

Press  (back).

In-Car Receiver

DSX-B700/DSX-B700W/DSX-B710D

General Setup (GENERAL)

AREA (area) (DSX-B700(EUR))

Specifies the area/region to use this unit: [EUROPE], [RUSSIA].

If the area/region currently set is changed, this unit is reset, then the clock is displayed.

(Available only while the source is off and the clock is displayed.)

LANGUAGE (language) (DSX-B700(E))

Changes the display language: [ENGLISH], [SPANISH].

DEMO (demonstration)

Activates the demonstration: [ON], [OFF].

CLOCK (clock)

Sets the clock: [AUTO <RDS>], [MANUAL].

For DSX-B710D:

Sets the clock: [AUTO <DAB>], [MANUAL].

TUNER STEP (tuner step) (DSX-B700(E)/DSX-B700(IN))

Sets the FM/AM tuning step of your country: [50K/9K], [100K/10K], [200K/10K].

(Available only while the source is off and the clock is displayed.)

BEEP (beep)

Activates the beep sound: [ON], [OFF].

AUTO OFF (auto off)

Shuts off automatically after a certain time when the unit is turned off and the clock is displayed (i.e. press and hold OFF for 1 second): [ON] (30 minutes), [OFF].

STEERING (steering)

Registers/resets the setting of the steering wheel remote control. (Available only while the source is off and the clock is displayed.)

Item	Detail
------	--------

Item	Detail
STR CONTROL (steering control)	Selects the input mode of the connected remote control. To prevent a malfunction, be sure to match the input mode with the connected remote control before use. [CUSTOM] (custom) Input mode for the steering wheel remote control. [PRESET] (preset) Input mode for the wired remote control excluding the steering wheel remote control. (Automatically selected when [RESETCUSTOM] is performed.)
EDIT CUSTOM (edit custom)	Registers the functions (SOURCE, ATT (attenuate), VOL (volume) +/-, SEEK +/-, VOICE, ON HOOK, OFF HOOK) to the steering wheel remote control: <ol style="list-style-type: none"> ➊ Rotate the control dial to select the function you want to assign to the steering wheel remote control, then press it. ➋ While [REGISTER] is blinking, press and hold the button on the steering wheel remote control you want to assign the function to. When registration is complete, [REGISTERED] is displayed. ➌ To register other functions, repeat steps ➊ and ➋. (Available only when [STR CONTROL] is set to [CUSTOM].)
RESETCUSTOM (reset custom)	Resets the registered functions of the steering wheel remote control: [YES], [NO]. (Available only when [STR CONTROL] is set to [CUSTOM].)

Note

- While making settings, only button operation on the unit is available. For safety, park your car before making this setting.
- If an error occurs while registering, all the previously-registered information remains. Restart registration from the function where the error occurred.
- This function may not be available on some vehicles. For details on the compatibility of your vehicle, visit the support site.

USB AUTOPLY (USB auto play)

Activates the USB auto play: [ON], [OFF].

USB MODE (USB mode)

Changes the USB mode: [ANDROID], [MSC/MTP].
(Available only when the USB source is selected.)

AF/TA (alternative frequencies/traffic announcement) (DSX-B700(EUR)/DSX-B710D)

Selects the alternative frequencies (AF) and traffic announcement (TA) setting: [AF-ON], [TA-ON], [AF/TA-ON], [AF/TA-OFF].

REGIONAL (regional) (DSX-B700(EUR)/DSX-B710D)

Restricts reception to a specific region: [ON], [OFF].
(Available only when FM is received.)

BTM (best tuning memory)

Presets stations automatically.
(Available only when the radio is selected.)

PARENTAL (parental) (DSX-B700(UC))

Sets the parental lock to [ON], [OFF], and edits the passcode.
(Available only when SiriusXM is selected.)

SXM SIGNAL (SiriusXM signal) (DSX-B700(UC))

Displays the current status of the SiriusXM signal strength: [NO SIGNAL] (signal level 0), [WEAK] (signal level 1), [GOOD] (signal level 2), [EXCELLENT] (signal level 3).
(Available only when SiriusXM is selected.)

SXM RESET (SiriusXM reset) (DSX-B700(UC))

Initializes the SiriusXM Connect Vehicle Tuner settings (preset channels/parental lock): [YES], [NO].
(Available only when SiriusXM is selected.)

SEEK BY (seek by) (DSX-B710D)

Sets the search mode for DAB station: [A-Z] (Search by station name), [STATION GP] (Search by station group).
(Available only when DAB source is selected.)

ANNOUNCE (announcement) (DSX-B710D)

Enables broadcast announcements: [ON], [OFF].
(Available when any source is selected.)

SOFTLINK (soft link) (DSX-B710D)

Searches for and tunes to the similar program automatically when the signal of the current program is too weak to receive: [ON], [OFF].
(Available only when DAB source is selected.)

ANT-PWR (antenna power) (DSX-B710D)

Supplies power to the DAB antenna (aerial) input terminal: [ON], [OFF].
(Available only when the unit is turned off or DAB source is selected.)

AUTO TUNE (auto tune) (DSX-B710D)

Performs an auto tune to update the list of stations in "Quick-BrowZer" mode.
(Available only when DAB source is selected.)

FIRMWARE (firmware)

(Available only while the source is off and the clock is displayed.)
Checks/updates the firmware version. For details, visit the support site.

Item	Detail
------	--------

Item	Detail
FW VERSION (firmware version)	Displays current firmware version.
FW UPDATE (firmware update)	Enters firmware update process: [YES], [NO]. Updating the firmware takes a few minutes to complete. During the update, do not turn the ignition to the OFF position, nor remove the USB device.

Related Topic

- [Customer Support Websites](#)

In-Car Receiver
DSX-B700/DSX-B700W/DSX-B710D

Sound Setup (SOUND)

This setup menu is not available when the source is off and the clock is displayed.

EQ10 PRESET (EQ10 preset)

Selects an equalizer curve from 10 equalizer curves or off.

Area/model	Equalizer curve name
DSX-B700(UC)/DSX-B700(EUR)/DSX-B700W/DSX-B710D	[OFF], [R&B], [ROCK], [POP], [HIP-HOP], [EDM], [JAZZ], [SOUL], [COUNTRY], [KARAOKE]*, [CUSTOM]
DSX-B700(E)	[OFF], [R&B], [ROCK], [POP], [HIP-HOP], [EDM], [JAZZ], [REGUETON], [SALSA], [KARAOKE]*, [CUSTOM]
DSX-B700(IN)	[BOLLYWOOD], [R&B], [ROCK], [POP], [HIP-HOP], [EDM], [JAZZ], [REGUETON], [KARAOKE]*, [CUSTOM], [OFF]

The equalizer curve setting can be memorized for each source.

* [KARAOKE] reduces the vocal sound but cannot fully remove it during playback. Also, using a microphone is not supported.

EQ10 CUSTOM (EQ10 custom)

Sets [CUSTOM] of EQ10.

Setting the equalizer curve: [B1] – [B10] (32 Hz, 63 Hz, 125 Hz, 250 Hz, 500 Hz, 1 kHz, 2 kHz, 4 kHz, 8 kHz, 16 kHz).

The volume level is adjustable in 1 dB steps, from -6 dB to +6 dB.

BALANCE (balance)

Adjusts the sound balance: [RIGHT-15] – [CENTER] – [LEFT-15].

FADER (fader)

Adjusts the relative level: [FRONT-15] – [CENTER] – [REAR-15].

SUBWOOFER (subwoofer)

Item	Detail
SUBW LEVEL (subwoofer level)	Adjusts the subwoofer volume level: [+6 dB] – [0 dB] – [-6 dB]. ([ATT] is displayed at the lowest setting.)
SUBW PHASE (subwoofer phase)	Selects the subwoofer phase: [NORMAL], [REVERSE].
LPF FREQ (low pass filter frequency)	Selects the subwoofer cut-off frequency: [80Hz], [100Hz], [120Hz].

HPF FREQ (high pass filter frequency)

Selects the front/rear speaker cut-off frequency: [OFF], [80Hz], [100Hz], [120Hz].

AUX VOLUME (AUX volume)

Adjusts the volume level for each connected auxiliary device: [+18 dB] – [0 dB] – [-8 dB]. This setting negates the need to adjust the volume level between sources. (Available only when the AUX is selected.)

BTA VOLUME (BLUETOOTH audio volume)

Adjusts the volume level for each connected BLUETOOTH device: [+6 dB] – [0 dB] – [-6 dB]. This setting negates the need to adjust the volume level between sources.

(Available only when the BT audio, application or Pandora® (DSX-B700(UC)/DSX-B700W) is selected.)

Display Setup (DISPLAY)

BLACK OUT (black out) (DSX-B700(E)/DSX-B700(IN))

Turns off the illumination automatically if no operation is performed for 5 seconds when any source is selected: [ON], [OFF].

To turn the light back on, press any button on the unit or the remote commander.

DIMMER (dimmer)

Change the display brightness: [OFF], [ON], [AUTO], [CLK] (clock). ([AUTO] is available only when the illumination control lead is connected, and the head lights are turned on.)

- To set this function to be active only during a fixed period, select [CLK], then set the start and end times.
- To set the brightness when the dimmer function is activated, set [DIMMER] to [ON], then adjust [BRIGHTNESS].
- To set the brightness when the dimmer function is deactivated, set [DIMMER] to [OFF], then adjust [BRIGHTNESS].

The brightness setting is stored and applied when the dimmer function is activated or deactivated.

BRIGHTNESS (brightness)

Adjusts the display brightness. The brightness level is adjustable: [1] – [10].

BUTTON-C (button color)

Sets a preset color or customized color for the buttons.

Item	Detail
COLOR (color)	Selects from 15 presets colors, 1 customized color.
CUSTOM-C (custom color)	Registers a customized color for the buttons. RGB RED, RGB GREEN, RGB BLUE Adjustable color range: [0] – [32] ([0] cannot be set for all color ranges).

SOUND SYNC (sound synchronization)

Activates the synchronization of the illumination with the sound: [ON], [OFF].

(Not available when no source is selected and the clock is displayed.)

AUTO SCROLL (auto scroll)

Scrolls long items automatically: [ON], [OFF].

(Not available when the AUX or radio is selected.)

In-Car Receiver

DSX-B700/DSX-B700W/DSX-B710D

BLUETOOTH Setup (BLUETOOTH)

PAIRING (pairing)

Connects up to two BLUETOOTH devices: [DEVICE 1], [DEVICE 2].

[DEVICE 1] or [DEVICE 2] will be changed to the paired device name after pairing is complete.

AUDIO DEV (audio device)

Selects the audio device. [*] appears on the device paired with [DEVICE 1] or the current A2DP compatible audio device.

RINGTONE (ringtone)

Select the source of the ringtone output from the speakers: [1] (ringtone preset in this unit), [2] (ringtone from the mobile phone*).

* Depending on the mobile phone, this setting may not be available.

AUTO ANSWER (auto answer)

Sets this unit to answer an incoming call automatically: [OFF], [1] (about 3 seconds), [2] (about 10 seconds).

AUTO PAIR (auto pairing)

Start BLUETOOTH pairing automatically when iOS device version 5.0 or later is connected via USB: [ON], [OFF].

BT SIGNAL (BLUETOOTH signal)

Activates/deactivates the BLUETOOTH function.

BT INITIAL (BLUETOOTH initialize)

Initializes all the BLUETOOTH related settings (pairing information, device information, etc.): [YES], [NO].

When disposing the unit, initialize all the settings.

(Available only while the source is off and the clock is displayed.)

VOICE-OUT (voice output)

Selects the speakers for handsfree calling:

[VOICE FRONT] (front speakers), [VOICE REAR] (rear speakers), [VOICE ALL] (all speakers).

(Available only while the source is off and the clock is displayed.)

In-Car Receiver
DSX-B700/DSX-B700W/DSX-B710D

“Sony | Music Center” Setup (SONY APP)

Establish and terminate “Sony | Music Center” function (connection).

In-Car Receiver
DSX-B700/DSX-B700W/DSX-B710D

Canceling the Demonstration Mode

You can cancel the demonstration display which appears when the source is off and the clock is displayed.

1 Press **MENU**, rotate the control dial to select **[GENERAL]**, then press it.

2 Rotate the control dial to select **[DEMO]**, then press it.

3 Rotate the control dial to select **[DEMO-OFF]**, then press it.

The setting is complete.

4 Press  (**back**) twice.

The display returns to normal reception/play mode.

In-Car Receiver

DSX-B700/DSX-B700W/DSX-B710D

Updating the Firmware

To update the firmware, visit the support site, then follow the online instructions.

Note

- Using a USB device (not supplied) is required for updating the firmware. Store the updater in the USB device, and connect the device to the USB port, then perform the update operation.
- Updating the firmware takes a few minutes to complete. During the update, do not turn the ignition to the OFF position, nor remove the USB device.

Related Topic

- [Customer Support Websites](#)

In-Car Receiver
 DSX-B700/DSX-B700W/DSX-B710D

Precautions

- Cool off the unit beforehand if your car has been parked in direct sunlight.
- Do not leave audio devices brought in inside the car, or it may cause malfunction due to high temperature in direct sunlight.
- Power antenna (aerial) extends automatically.

To maintain high sound quality

Do not splash liquid onto the unit.

Playback order of audio files

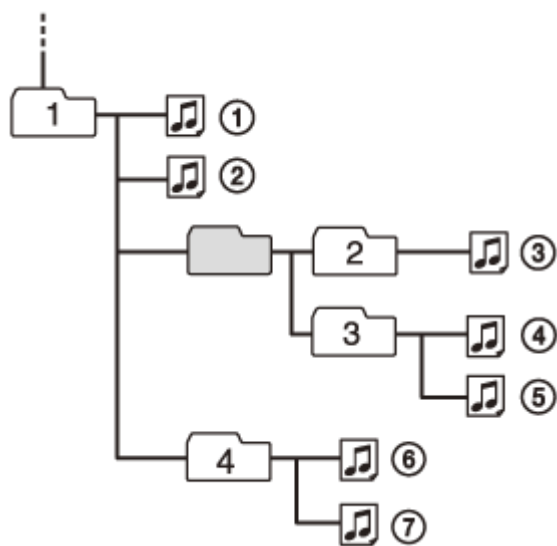

 : Folder (album)  : Audio file (track)

About iPod

- You can connect to the following iPod models. Update your iPod devices to the latest software before use.

Compatible iPhone/iPod models

Compatible Model	Bluetooth®	USB
iPhone XR	✓	✓
iPhone Xs max	✓	✓
iPhone Xs	✓	✓
iPhone X	✓	✓
iPhone 8	✓	✓
iPhone 8 Plus	✓	✓
iPhone 7	✓	✓
iPhone 7 Plus	✓	✓

Compatible Model	Bluetooth®	USB
iPhone SE	✓	✓
iPhone 6s	✓	✓
iPhone 6s Plus	✓	✓
iPhone 6	✓	✓
iPhone 6 Plus	✓	✓
iPhone 5s	✓	✓
iPhone 5c	✓	✓
iPhone 5	✓	✓
iPhone 4s	✓	✓
iPod touch (6th generation)	✓	✓
iPod touch (5th generation)	✓	✓
iPod nano (7th generation)		✓

- Use of the Made for Apple badge means that an accessory has been designed to connect specifically to the Apple product(s) identified in the badge, and has been certified by the developer to meet Apple performance standards. Apple is not responsible for the operation of this device or its compliance with safety and regulatory standards. Please note that the use of this accessory with an Apple product may affect wireless performance.

If you have any questions or problems concerning your unit that are not covered in this manual, consult your nearest Sony dealer.

In-Car Receiver
DSX-B700/DSX-B700W/DSX-B710D

Maintenance

Replacing the lithium battery (CR2025) of the remote commander (DSX-B700(UC)/DSX-B700(E)/DSX-B700(IN)DSX-B700W)

When the battery becomes weak, the range of the remote commander becomes shorter.

CAUTION

Danger of explosion if battery is incorrectly replaced. Replace only with the same or equivalent type.

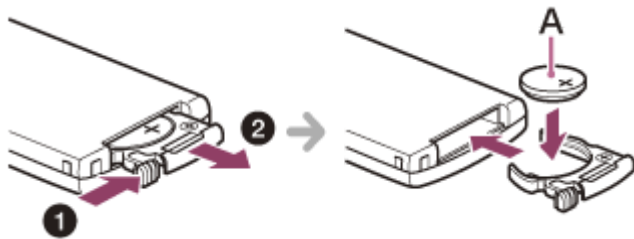

A: Lithium battery (CR2025) + side up

Note

- Keep the lithium battery out of the reach of children. Should the battery be swallowed, immediately consult a doctor.

In-Car Receiver
 DSX-B700/DSX-B700W/DSX-B710D

Specifications

FOR THE CUSTOMERS IN THE USA. NOT APPLICABLE IN CANADA, INCLUDING IN THE PROVINCE OF QUEBEC.

POUR LES CLIENTS AUX ÉTATS-UNIS. NON APPLICABLE AU CANADA, Y COMPRIS LA PROVINCE DE QUÉBEC.

AUDIO POWER SPECIFICATIONS



CTA2006 Standard
 Power Output: 20 Watts RMS × 4 at 4 Ohms < 1% THD+N
 SN Ratio: 80 dBA (reference: 1 Watt into 4 Ohms)

Tuner section

DSX-B700(UC)/DSX-B700W:

FM

Tuning range	87.5 MHz – 107.9 MHz
Usable sensitivity	7 dBf
Signal-to-noise ratio	73 dB
Separation	50 dB at 1 kHz

AM

Tuning range	530 kHz – 1,710 kHz
Sensitivity	26 µV

DSX-B700(EUR):

FM

Tuning range	When [AREA] is set to [EUROPE]: 87.5 MHz – 108.0 MHz When [AREA] is set to [RUSSIA]: FM1/FM2: 87.5 MHz – 108.0 MHz (at 50 kHz step) FM3: 65 MHz – 74 MHz (at 30 kHz step)
Usable sensitivity	7 dBf
Signal-to-noise ratio	73 dB
Separation	50 dB at 1 kHz

AM/LW

Tuning range	531 kHz – 1,602 kHz (AM) 153 kHz – 279 kHz (LW)
Sensitivity	26 μ V (AM) 50 μ V (LW)

DSX-B700(E)/DSX-B700(IN):**FM**

Tuning range	87.5 MHz – 108.0 MHz (at 50 kHz step) 87.5 MHz – 108.0 MHz (at 100 kHz step) 87.5 MHz – 107.9 MHz (at 200 kHz step)
FM tuning step	50 kHz/100 kHz/200 kHz switchable
Usable sensitivity	7 dBf
Signal-to-noise ratio	73 dB
Separation	50 dB at 1 kHz

AM

Tuning range	531 kHz – 1,602 kHz (at 9 kHz step) 530 kHz – 1,710 kHz (at 10 kHz step)
AM tuning step	9 kHz/10 kHz switchable
Sensitivity	26 μ V

DSX-B710D:**DAB/DAB+**

Tuning range	174.928 MHz – 239.200 MHz
Antenna (aerial) terminal	External antenna (aerial) connector

FM

Tuning range	87.5 MHz – 108.0 MHz
Usable sensitivity	7 dBf
Signal-to-noise ratio	73 dB
Separation	50 dB at 1 kHz

AM/LW

Tuning range	531 kHz – 1,602 kHz (AM) 153 kHz – 279 kHz (LW)
Sensitivity	26 μ V (AM) 50 μ V (LW)

USB player section

Interface	USB (Full speed)
Maximum current	1 A
Maximum number of recognizable folders and files	Folders (albums): 256 Files (tracks) per folder: 256
Compatible Android Open Accessory protocol (AOA)	2.0
Corresponding codec	MP3 (.mp3) Bit rate: 8 kbps – 320 kbps (Supports VBR (Variable Bit Rate)) Sampling rate: 16 kHz – 48 kHz WMA (.wma) Bit rate: 32 kbps – 192 kbps (Supports VBR (Variable Bit Rate)) Sampling rate: 32 kHz, 44.1 kHz, 48 kHz AAC (.m4a, .mp4) Bit rate: 16 kbps – 320 kbps (stereo) Sampling rate: 8 kHz – 48 kHz FLAC (.flac) Bit depth: 16 bit, 24 bit Sampling rate: 44.1 kHz, 48 kHz
Supported file system	FAT16, FAT32

Wireless communication

Communication System	BLUETOOTH Standard version 3.0
Output	BLUETOOTH Standard Power Class 2 (Max. Conducted +1 dBm)
Maximum communication range*1	Line of sight approx. 10 m (33 ft)
Frequency band	2.4 GHz band (2.4000 GHz – 2.4835 GHz)
Modulation method	FHSS
Compatible BLUETOOTH Profiles*2	A2DP (Advanced Audio Distribution Profile) 1.3 AVRCP (Audio Video Remote Control Profile) 1.3 HFP (Handsfree Profile) 1.6 PBAP (Phone Book Access Profile) SPP (Serial Port Profile)
Corresponding codec	SBC (.sbc), AAC (.m4a)

*1 The actual range will vary depending on factors such as obstacles between devices, magnetic fields around a microwave oven, static electricity, reception sensitivity, antenna (aerial) performance, operating system, software application, etc.

*2 BLUETOOTH standard profiles indicate the purpose of BLUETOOTH communication between devices.

Power amplifier section

Output	Speaker outputs
Speaker impedance	4 Ω – 8 Ω
Maximum power output	55 W × 4 (at 4 Ω)

General

Power requirements	12 V DC car battery (negative ground (earth))
--------------------	---

Rated current consumption	10 A
Dimensions	Approx. 178 mm × 100 mm × 177 mm (7 1/8 in × 4 in × 7 in) (w/h/d)
Mounting dimensions	Approx. 182 mm × 111 mm × 159 mm (7 1/4 in × 4 3/8 in × 6 3/8 in) (w/h/d)
Mass	Approx. 1.0 kg (2 lb 4 oz)
Package contents	Main unit (1) Remote commander (1): RM-X231 (DSX-B700(UC)/DSX-B700(E)/DSX-B700(IN)/DSX-B700W) Parts for installation and connections (1 set)
Optional accessories/equipment	SiriusXM Connect Vehicle Tuner: SXV100, SXV200, SXV300 (DSX-B700(UC)) Cable for steering wheel remote input: RC-SR1

Ask the dealer for detailed information.

Design and specifications are subject to change without notice.

In-Car Receiver
DSX-B700/DSX-B700W/DSX-B710D

Copyrights



SiriusXM Connect Vehicle Tuner and Subscription sold separately.

www.siriusxm.com

Sirius, XM and all related marks and logos are trademarks of Sirius XM Radio Inc. All rights reserved.

The Bluetooth® word mark and logos are registered trademarks owned by the Bluetooth SIG, Inc. and any use of such marks by Sony Corporation is under license. Other trademarks and trade names are those of their respective owners.

Windows Media is either a registered trademark or trademark of Microsoft Corporation in the United States and/or other countries.

This product is protected by certain intellectual property rights of Microsoft Corporation. Use or distribution of such technology outside of this product is prohibited without a license from Microsoft or an authorized Microsoft subsidiary.

Apple, iPhone, iPod, iPod nano, iPod touch, and Siri are trademarks of Apple Inc., registered in the U.S. and other countries. App Store is a service mark of Apple Inc.

IOS is a trademark or registered trademark of Cisco in the U.S. and other countries and is used under license.

PANDORA, the PANDORA logo, and the Pandora trade dress are trademarks or registered trademarks of Pandora Media, LLC. Used with permission.

Google, Google Play and Android are trademarks of Google LLC.

In-Car Receiver

DSX-B700/DSX-B700W/DSX-B710D

Troubleshooting

Do the following before you request a repair service.

- Read the relevant instruction and troubleshooting topics in this Help Guide.
- Issues may be resolved by updating the software. When you install the “Support by Sony” app on your smartphone, you can get software update information conveniently.
- Visit our customer support home page.

If none of the above works, consult your nearest Sony dealer.

In-Car Receiver
DSX-B700/DSX-B700W/DSX-B710D

No power is being supplied to the unit. (DSX-B700(UC)/DSX-B700(E)/DSX-B700(IN)/DSX-B700W)

- If the unit is turned off and the display disappears, the unit cannot be operated with the remote commander.
 - Turn on the unit.

In-Car Receiver

DSX-B700/DSX-B700W/DSX-B710D

No sound or the sound is very low.

- The position of the fader control [FADER] is not set for a 2-speaker system.
- The volume of the unit and/or connected device is very low.
 - Increase the volume of the unit and connected device.

5-004-923-11(4) Copyright 2019 Sony Corporation

In-Car Receiver

DSX-B700/DSX-B700W/DSX-B710D

No beep sound.

-
- An optional power amplifier is connected and you are not using the built-in amplifier.

In-Car Receiver
DSX-B700/DSX-B700W/DSX-B710D

The contents of the memory have been erased.

- The power supply leads or battery has been disconnected or not connected properly.

In-Car Receiver

DSX-B700/DSX-B700W/DSX-B710D

Preset stations and correct time are erased. / The fuse has blown. / Makes a noise when the position of the ignition is switched.

-
- The leads are not matched correctly with the car's accessory power connector.

5-004-923-11(4) Copyright 2019 Sony Corporation

In-Car Receiver

DSX-B700/DSX-B700W/DSX-B710D

During playback or reception, the demonstration mode starts.

-
- If no operation is performed for 5 minutes with [DEMO-ON] set, the demonstration mode starts.
 - Set [DEMO-OFF].
-
-

Related Topic

- [General Setup \(GENERAL\)](#)

In-Car Receiver

DSX-B700/DSX-B700W/DSX-B710D

The display disappears from/does not appear in the display window.

- The dimmer is set to [DIMMER-ON].
 - The display disappears if you press and hold OFF.
 - Press OFF on the unit until the display appears.
-
-

Related Topic

- [Display Setup \(DISPLAY\)](#)

In-Car Receiver
DSX-B700/DSX-B700W/DSX-B710D

The display disappears while the unit is operating. (DSX-B700(E)/DSX-B700(IN))

- [BLACK OUT] (black out) is set to [B.OUT-ON].
-

Related Topic

- [Display Setup \(DISPLAY\)](#)

In-Car Receiver
DSX-B700/DSX-B700W/DSX-B710D

The display/illumination flashes.

- The power supply is not sufficient.
 - Check that the car battery supplies enough power to the unit. (The power requirement is 12 V DC.)

5-004-923-11(4) Copyright 2019 Sony Corporation

In-Car Receiver

DSX-B700/DSX-B700W/DSX-B710D

The operation buttons do not function.

- The connection is not correct.
 - Press and hold DSPL (display) and CALL  for more than 2 seconds to reset the unit.
The contents stored in memory are erased.
For your safety, do not reset the unit while you are driving.
-
-

Related Topic

- [Resetting the Unit](#)

In-Car Receiver

DSX-B700/DSX-B700W/DSX-B710D

The clock set automatically is not accurate.

- The clock data on radio waves is not accurate.
 - Press MENU, set [CLOCK] in [GENERAL] to [MANUAL], then adjust the clock manually.
-
-

Related Topic

- [Setting the Clock](#)

In-Car Receiver

DSX-B700/DSX-B700W/DSX-B710D

The radio reception is poor. / Static noise occurs.

- Connect the antenna (aerial) firmly.

5-004-923-11(4) Copyright 2019 Sony Corporation

In-Car Receiver

DSX-B700/DSX-B700W/DSX-B710D

The stations cannot be received.

- The tuning step setting has been erased.
 - Set the tuning step again. (DSX-B700(E)/DSX-B700(IN))
-
-

Related Topic

- [Switching the FM/AM Tuning Step \(DSX-B700\(E\)/DSX-B700\(IN\)\)](#)

In-Car Receiver

DSX-B700/DSX-B700W/DSX-B710D

Preset tuning is not possible.

- The broadcast signal is too weak.

5-004-923-11(4) Copyright 2019 Sony Corporation

In-Car Receiver

DSX-B700/DSX-B700W/DSX-B710D

65 MHz to 74 MHz in FM3 cannot be tuned in. (DSX-B700(EUR))

- [AREA] is set to [EUROPE].
 - Set [AREA] to [RUSSIA].
-
-

Related Topic

- [General Setup \(GENERAL\)](#)

5-004-923-11(4) Copyright 2019 Sony Corporation

In-Car Receiver

DSX-B700/DSX-B700W/DSX-B710D

PTY displays [- - - - -].

- The current station is not an RDS station.
- RDS data has not been received.
- The station does not specify the program type.

5-004-923-11(4) Copyright 2019 Sony Corporation

In-Car Receiver

DSX-B700/DSX-B700W/DSX-B710D

RDS services cannot be received (when [AREA] is set to [RUSSIA]). (DSX-B700(EUR))

- FM3 is selected.
 - Select FM1 or FM2.

- RDS services are unavailable in the current region.

5-004-923-11(4) Copyright 2019 Sony Corporation

In-Car Receiver
DSX-B700/DSX-B700W/DSX-B710D

The SEEK starts after a few seconds of listening. (DSX-B700(EUR)/DSX-B710D)

- The station is non-TP or has weak signal.
 - Deactivate TA.
-

Related Topic

- [Setting AF and TA \(DSX-B700\(EUR\)/DSX-B710D\)](#)
- [General Setup \(GENERAL\)](#)

In-Car Receiver

DSX-B700/DSX-B700W/DSX-B710D

No traffic announcements. (DSX-B700(EUR)/DSX-B710D)

- Activate TA.
 - The station does not broadcast any traffic announcements despite being TP.
 - Tune in another station.
-

Related Topic

- [Setting AF and TA \(DSX-B700\(EUR\)/DSX-B710D\)](#)
- [General Setup \(GENERAL\)](#)

In-Car Receiver

DSX-B700/DSX-B700W/DSX-B710D

Program service name flashes. (DSX-B700(EUR)/DSX-B710D)

- Program service name flashes.
 - Press **◀◀ / ▶▶** (SEEK -/+) while the program service name is flashing. [PI SEEK] appears and the unit starts searching for another frequency with the same PI (program identification) data.

In-Car Receiver
DSX-B700/DSX-B700W/DSX-B710D

DAB stations cannot be received.

- See [NO STATION] for details.
-

Related Topic

- [DAB/DAB+ Radio Reception \(DSX-B710D\)](#)

5-004-923-11(4) Copyright 2019 Sony Corporation

In-Car Receiver

DSX-B700/DSX-B700W/DSX-B710D

No traffic announcements.

- Disable DAB announcements.
 - Traffic announcements are disabled while DAB announcements are enabled.
-
-

Related Topic

- [Setting DAB Announcements](#)

5-004-923-11(4) Copyright 2019 Sony Corporation

In-Car Receiver
DSX-B700/DSX-B700W/DSX-B710D

You cannot play items via a USB hub.

- This unit cannot recognize USB devices via a USB hub.

5-004-923-11(4) Copyright 2019 Sony Corporation

In-Car Receiver

DSX-B700/DSX-B700W/DSX-B710D

A USB device takes longer to play.

- The USB device contains files with a complicated tree structure.

5-004-923-11(4) Copyright 2019 Sony Corporation

In-Car Receiver

DSX-B700/DSX-B700W/DSX-B710D

The sound is intermittent.

- The sound may be intermittent at a high-bit-rate.
- DRM (Digital Rights Management) files may not be playable in some cases.

5-004-923-11(4) Copyright 2019 Sony Corporation

In-Car Receiver
DSX-B700/DSX-B700W/DSX-B710D

The audio file cannot be played.

- USB device formatted with file systems other than FAT16 or FAT32 are unsupported.*

* This unit supports FAT16 and FAT32, but some USB device may not support all of these FAT. For details, refer to the operating instruction of each USB device or contact the manufacturer.

In-Car Receiver

DSX-B700/DSX-B700W/DSX-B710D

Operations for skipping an album, skipping items (Jump mode), and searching a track by name (“Quick-BrowZer”) cannot be performed.

- These operations cannot be performed when a USB device in Android mode or iPod is connected.
 - Set [USB MODE] to [MSC/MTP].
 - Remove the iPod.

 - The USB mode of the device is not set to the appropriate mode.
 - Make sure that the USB mode of the device is set to MSC/MTP mode.
-

Related Topic

- [General Setup \(GENERAL\)](#)

In-Car Receiver
DSX-B700/DSX-B700W/DSX-B710D

The sound cannot be output during playback in Android mode.

- While the unit is in Android mode, the sound outputs only from the Android smartphone.
 - Check the status of the audio playback application on the Android smartphone.
 - Playback may not perform properly depending on the Android smartphone.

5-004-923-11(4) Copyright 2019 Sony Corporation

In-Car Receiver

DSX-B700/DSX-B700W/DSX-B710D

The connecting device cannot detect this unit.

- Before the pairing is made, set this unit to pairing standby mode.
 - While connected to two BLUETOOTH devices, this unit cannot be detected from another device.
 - Disconnect either connection and search for this unit from another device.
 - When the device pairing is made, set the BLUETOOTH signal output to on.
-

Related Topic

- [Pairing and Connecting with a BLUETOOTH Device](#)

5-004-923-11(4) Copyright 2019 Sony Corporation

In-Car Receiver

DSX-B700/DSX-B700W/DSX-B710D

Connection is not possible.

-
- The connection is controlled from one side (this unit or BLUETOOTH device), but not both.
 - Connect to this unit from a BLUETOOTH device or vice versa.

5-004-923-11(4) Copyright 2019 Sony Corporation

In-Car Receiver

DSX-B700/DSX-B700W/DSX-B710D

The name of the detected device does not appear.

-
- Depending on the status of the other device, it may not be possible to obtain the name.

5-004-923-11(4) Copyright 2019 Sony Corporation

In-Car Receiver

DSX-B700/DSX-B700W/DSX-B710D

No ringtone.

- Adjust the volume by rotating the control dial while receiving a call.
 - Depending on the connecting device, the ringtone may not be sent properly.
 - Set [RINGTONE] to [1].
 - The speakers are not connected to the unit.
 - Connect the speakers to the unit. To select the speakers for ringtone, press MENU, then select [BLUETOOTH] → [VOICE-OUT].
-

Related Topic

- [BLUETOOTH Setup \(BLUETOOTH\)](#)

In-Car Receiver

DSX-B700/DSX-B700W/DSX-B710D

The talker's voice cannot be heard.

- The speakers are not connected to the unit.
 - Connect the speakers to the unit. To select the speakers for talker's voice, press MENU, then select [BLUETOOTH] → [VOICE-OUT].
-

Related Topic

- [BLUETOOTH Setup \(BLUETOOTH\)](#)

In-Car Receiver
DSX-B700/DSX-B700W/DSX-B710D

A call partner says that the volume is too low or high.

- Adjust the volume accordingly using mic gain adjustment.
-

Related Topic

- [Available Operations during Call](#)

5-004-923-11(4) Copyright 2019 Sony Corporation

In-Car Receiver

DSX-B700/DSX-B700W/DSX-B710D

Echo or noise occurs in phone call conversations.

- Lower the volume.
 - Set EC/NC Mode to [EC/NC-1] or [EC/NC-2].
 - If the ambient noise other than the phone call sound is loud, try reducing this noise.
E.g.: If a window is open and road noise, etc., is loud, shut the window. If an air conditioner is loud, lower the air conditioner.
-

Related Topic

- [Available Operations during Call](#)

In-Car Receiver

DSX-B700/DSX-B700W/DSX-B710D

The phone is not connected.

-
- When BLUETOOTH audio is played, the phone is not connected even if you press CALL.
 - Connect from the phone.
-
-

Related Topic

- [Sound Setup \(SOUND\)](#)

In-Car Receiver

DSX-B700/DSX-B700W/DSX-B710D

The phone sound quality is poor.

- Phone sound quality depends on reception conditions of mobile phone.
 - Move your car to a place where you can enhance the mobile phone's signal if the reception is poor.

5-004-923-11(4) Copyright 2019 Sony Corporation

In-Car Receiver

DSX-B700/DSX-B700W/DSX-B710D

The volume of the connected audio device is low (high).

- Volume level will differ depending on the audio device.
 - Adjust the volume of the connected audio device or this unit.

5-004-923-11(4) Copyright 2019 Sony Corporation

In-Car Receiver

DSX-B700/DSX-B700W/DSX-B710D

The sound skips during playback of a BLUETOOTH audio device.

- Reduce the distance between the unit and the BLUETOOTH audio device.
- If the BLUETOOTH audio device is stored in a case which interrupts the signal, remove the audio device from the case during use.
- Several BLUETOOTH devices or other devices which emit radio waves are in use nearby.
 - Turn off the other devices.
 - Increase the distance from the other devices.
- The playback sound stops momentarily when the connection between this unit and the mobile phone is being made. This is not a malfunction.

In-Car Receiver

DSX-B700/DSX-B700W/DSX-B710D

The connected BLUETOOTH audio device cannot be controlled.

- Check that the connected BLUETOOTH audio device supports AVRCP.

5-004-923-11(4) Copyright 2019 Sony Corporation

In-Car Receiver
DSX-B700/DSX-B700W/DSX-B710D

Some functions do not work.

-
- Check if the connecting device supports the functions in question.

5-004-923-11(4) Copyright 2019 Sony Corporation

In-Car Receiver

DSX-B700/DSX-B700W/DSX-B710D

A call is answered unintentionally.

- The connecting phone is set to answer a call automatically.

5-004-923-11(4) Copyright 2019 Sony Corporation

In-Car Receiver

DSX-B700/DSX-B700W/DSX-B710D

Pairing failed due to a timeout.

- Depending on the connecting device, the time limit for pairing may be short.
 - Try completing the pairing within the time.

5-004-923-11(4) Copyright 2019 Sony Corporation

In-Car Receiver

DSX-B700/DSX-B700W/DSX-B710D

Cannot pair.

-
- The unit may not be able to pair with a previously paired BLUETOOTH device after initializing the unit if the pairing information of the unit is on the BLUETOOTH device. In this case, delete the pairing information of the unit from the BLUETOOTH device, and then pair them again.

In-Car Receiver

DSX-B700/DSX-B700W/DSX-B710D

BLUETOOTH function cannot operate.

-
- Turn off the unit by pressing and holding OFF for more than 2 seconds, then turn the unit on again.

5-004-923-11(4) Copyright 2019 Sony Corporation

In-Car Receiver

DSX-B700/DSX-B700W/DSX-B710D

No sound is output from the car speakers during handsfree call.

-
- If the sound is output from the mobile phone, set the mobile phone to output the sound from the car speakers.

In-Car Receiver

DSX-B700/DSX-B700W/DSX-B710D

“Siri Eyes Free” is not activated.

- Perform the handsfree registration for an iPhone that supports “Siri Eyes Free”.
- Set the Siri function on the iPhone to on.
- Cancel the BLUETOOTH connection with the iPhone and the unit, and reconnect.

5-004-923-11(4) Copyright 2019 Sony Corporation

In-Car Receiver

DSX-B700/DSX-B700W/DSX-B710D

Application name is mismatched with the actual application in “Sony | Music Center”.

- Launch the application again from the “Sony | Music Center” application.

5-004-923-11(4) Copyright 2019 Sony Corporation

In-Car Receiver
DSX-B700/DSX-B700W/DSX-B710D

While running the “Sony | Music Center” application via BLUETOOTH, the display automatically switches to [BT AUDIO].

- The “Sony | Music Center” application or BLUETOOTH function has failed.
- Run the application again.

5-004-923-11(4) Copyright 2019 Sony Corporation

In-Car Receiver

DSX-B700/DSX-B700W/DSX-B710D

The “Sony | Music Center” application is automatically disconnected when the display switches to [IPOD].

- The “Sony | Music Center” application on iPhone/iPod does not support iPod playback.
 - Change the source of the unit to other than [IPOD], then establish the “Sony | Music Center” connection.
-

Related Topic

- [Establishing the “Sony | Music Center” Connection](#)

In-Car Receiver

DSX-B700/DSX-B700W/DSX-B710D

The “Sony | Music Center” connection is automatically disconnected when the USB mode of the unit is changed to [ANDROID].

- The Android smartphone is not supporting playback in Android mode.
 - Set the USB mode of the unit to [MSC/MTP], then establish the “Sony | Music Center” connection.
-
-

Related Topic

- [Establishing the “Sony | Music Center” Connection](#)

In-Car Receiver

DSX-B700/DSX-B700W/DSX-B710D

Pandora® connection is not possible.

-
- Shut down the Pandora® application on the mobile device, and then launch it again.

5-004-923-11(4) Copyright 2019 Sony Corporation

In-Car Receiver
DSX-B700/DSX-B700W/DSX-B710D

General

The following messages may appear or flash during operation.

INVALID

- The selected operation could be invalid.

READ: Now reading information.

- Wait until reading is complete and playback starts automatically. This may take some time depending on the file organization.

_ (underscore): The character cannot be displayed.

In-Car Receiver

DSX-B700/DSX-B700W/DSX-B710D

USB Device Playback

HUB NO SUPPORT: USB hubs are not supported.

IPOD STOP: iPod playback has finished.

- Operate your iPod/iPhone to start playback.

NOT SUPPORT ANDROID MODE

- A USB device not supporting AOA (Android Open Accessory) 2.0 is connected to the unit while [USB MODE] is set to [ANDROID].
 - Set [USB MODE] to [MSC/MTP].

USB ERROR: The USB device cannot be played.

- Connect the USB device again.

USB NO DEVICE: A USB device is not connected or recognized.

- Make sure the USB device or USB cable is securely connected.

USB NO MUSIC: There is no playable file.

- Connect a USB device containing playable files.

USB NO SUPPORT: The USB device is not supported.

- For details on the compatibility of your USB device, visit the support site.

USB OVERLOAD: The USB device is overloaded.

- Disconnect the USB device, then press SRC (source) to select another source.
- The USB device has a fault, or an unsupported device is connected.

Related Topic

- [General Setup \(GENERAL\)](#)
- [Specifications](#)

In-Car Receiver

DSX-B700/DSX-B700W/DSX-B710D

RDS Operation (DSX-B700(EUR)/DSX-B710D)

NO AF: No alternative frequencies.

- Press **◀◀ / ▶▶** (SEEK -/+) while the program service name is flashing. The unit starts searching for another frequency with the same PI (program identification) data ([PI SEEK] appears).

NO PI: No program identification. The selected station has no PI (program identification) data.

- Select another station.

NO TP: No traffic programs.

- The unit will continue searching for available TP stations.

In-Car Receiver

DSX-B700/DSX-B700W/DSX-B710D

DAB/DAB+ Radio Reception (DSX-B710D)

NO INFO

- There is no label information for the current DAB station.

NO STATION: The DAB signal cannot be received.

- Perform an auto tune.
- Check the connection of the DAB antenna (aerial).
- Check that [ANT-PWR] is set to [ON].

RECEIVING

- The DAB source is selected and the unit is waiting to receive a station.
-
-

Related Topic

- [General Setup \(GENERAL\)](#)
- [Updating the Station List \(Auto tune\)](#)

In-Car Receiver

DSX-B700/DSX-B700W/DSX-B710D

BLUETOOTH Function

BT AUDIO NO DEVICE: A BLUETOOTH audio device is not connected or recognized.

- Make sure a BLUETOOTH audio device is securely connected, or the BLUETOOTH connection is established with the BLUETOOTH audio device.

ERROR: The selected operation could not be performed.

- Wait for a while, then try again.

NO DEVICE: A mobile phone with HFP (Handsfree Profile) is not connected or recognized.

- Make sure a mobile phone with HFP is securely connected, or the BLUETOOTH connection is established with mobile phone with HFP.

NO INFO: The phone number is hidden by the caller.

NO SUPPORT: The selected operation is not allowed or supported.

- Make sure the BLUETOOTH device is supporting HFP (Handsfree Profile).

UNKNOWN: A name or phone number cannot be displayed.

In-Car Receiver
DSX-B700/DSX-B700W/DSX-B710D

“Sony | Music Center” Operation

APP -----: A connection with the application is not established.

- Make the “Sony | Music Center” connection again.

APP DISPLAY: A screen setting display of the application is open.

- Exit the screen setting display of the application to enable button operation.

APP LIST: The contents list of the USB/iPod is open.

- Exit the list of the application to enable button operation.

APP MENU: A setting display of the application is open.

- Exit the setting display of the application to enable button operation.

APP NO DEVICE: The device with the application installed is not connected or recognized.

- Make the BLUETOOTH connection and establish the “Sony | Music Center” connection again.

APP SOUND: A sound setting display of the application is open.

- Exit the sound setting display of the application to enable button operation.

OPEN SONY APP: The “Sony | Music Center” application is not running.

- Launch the application.

SONY APP DISCNCTED: The application is disconnected.

- Make the “Sony | Music Center” connection.

Related Topic

- [Establishing the “Sony | Music Center” Connection](#)

In-Car Receiver

DSX-B700/DSX-B700W/DSX-B710D

Pandora® Operation (DSX-B700(UC)/DSX-B700W)

PANDORA BOOKMARK ERROR: Bookmarking failed.

- Wait for a while, then try again.

LOG IN ERROR: You are not logged into your Pandora® account.

- Disconnect the device, log into your Pandora® account, then connect the device again.

PANDORA NO DEVICE: The BLUETOOTH device is not connected or recognized.

- Make sure the BLUETOOTH device is securely connected, or the BLUETOOTH connection is established with the BLUETOOTH device. Then, select the Pandora® source again.

PANDORA NO STATIONS: No stations on your account.

- Create the station on the mobile device.

NOT ALLOWED: The selected operation is not allowed.

- “Thumbs” feedback is not allowed.
 - Wait until the commercial ends.
 - Some functions, such as Shared Station, do not permit feedback. Wait until the next track begins, or select another station on the list.
- Bookmark is not allowed.
 - Wait until the commercial ends.
 - Select another track or station, then try it again.

PANDORA UNAVAILABLE: Pandora® is not available outside your country or the selected station is no longer available or expired.

- Select another station.

PANDORA ERROR: The selected operation could not be performed or the Pandora® server is under maintenance.

- Wait for a while, then try again.

PANDORA NOT FOUND: Pandora® is not on your device or is not running.

- Make sure the Pandora® application is installed and running properly. Then, select the Pandora® source again.

PANDORA BAD NETWORK: The network connection is unstable or lost.

- Make the network connection again on the device, or wait until the network connection is established.

SKIP LIMIT: Skipping tracks is not allowed.

- Wait until the commercial ends, next track begins, or select another station on the list. Pandora® limits the number of skips allowed on their service.

THUMBS ERROR: “Thumbs” feedback failed.

- Wait for a while, then try again.

PANDORA UPDATE APP: An old version of Pandora® is connected.

- Update the Pandora® application to the latest version.

5-004-923-11(4) Copyright 2019 Sony Corporation

In-Car Receiver

DSX-B700/DSX-B700W/DSX-B710D

SiriusXM Operation (DSX-B700(UC))

CHANNEL LOCKED

- The channel that you have requested is locked by the radio parental control feature.

CHANNEL NOT AVAILABLE

- The channel that you have requested is not a valid SiriusXM channel or the channel that you were listening to is no longer available.
- You may also see this message briefly when first connecting a new SiriusXM Connect Vehicle Tuner. Visit www.siriusxm.com in the USA or www.siriusxm.ca in Canada for SiriusXM channel lineup information.

CHANNEL NOT SUBSCRIBED

- The channel that you have requested is not included in your SiriusXM subscription package or the channel that you were listening to is no longer included in your SiriusXM subscription package. If you have questions about your subscription package or would like to subscribe to this channel, please contact SiriusXM. In the USA, visit www.siriusxm.com or call 1-866-635-2349. In Canada, visit www.siriusxm.ca or call 1-877-438-9677.

CHECK ANTENNA

- The radio has detected a fault with the SiriusXM antenna (aerial).
- The antenna (aerial) cable may be either disconnected or damaged.
 - Verify that the antenna (aerial) cable is connected to the SiriusXM Connect Vehicle Tuner.
 - Inspect the antenna (aerial) cable for damage and kinks.
 - Replace the antenna (aerial) if the cable is damaged. SiriusXM products are available at your local car audio retailer or online at <https://shop.siriusxm.com/all-parts/>

CHECK TUNER

- The radio is having difficulty communicating with the SiriusXM Connect Vehicle Tuner.
- The tuner may be disconnected or damaged.
 - Verify that the SiriusXM Connect Vehicle Tuner cable is securely connected to the radio.

INCORRECT PASS CODE ENTERED

- The entered passcode is incorrect.
 - Enter the correct passcode.
 - If you forget your passcode, perform [SXM RESET] in [GENERAL]. Note that performing [SXM RESET] will initialize all the SiriusXM settings and stored contents in the SiriusXM Connect Vehicle Tuner.

NO SIGNAL

- SiriusXM Connect Vehicle Tuner is having difficulty receiving the SiriusXM satellite signal.
 - Verify that your vehicle is outdoors with a clear view of the sky.
 - Verify that the SiriusXM magnetic mount antenna (aerial) is mounted on a metal surface on the outside of the vehicle.

- Move the SiriusXM antenna (aerial) away from any obstructions.
- Inspect the antenna (aerial) cable for damage and kinks.
- Consult the SiriusXM Connect Vehicle Tuner installation manual for more information on antenna (aerial) installation.
- Replace the antenna (aerial) if the cable is damaged. SiriusXM products are available at your local car audio retailer or online at <https://shop.siriusxm.com/all-parts/>

SUBSCRIP UPDATED - PRESS ENTER TO CONTINUE

- The radio has detected a change in your SiriusXM subscription status.
 - Press ENTER to clear the message.
If you have questions about your subscription, please contact SiriusXM. In the USA, visit www.siriusxm.com or call 1-866-635-2349.
In Canada, visit www.siriusxm.ca or call 1-877-438-9677.

Related Topic

- [Setting a Parental Control](#)
- [General Setup \(GENERAL\)](#)

5-004-923-11(4) Copyright 2019 Sony Corporation

In-Car Receiver

DSX-B700/DSX-B700W/DSX-B710D

Steering Wheel Remote Control Operation

ERROR: An error occurred during the function registration.

- Register again from the function where the error occurred.

TIMEOUT: The function registration failed due to a timeout.

- Try completing the registration while [REGISTER] is blinking (about 6 seconds).
-

Related Topic

- [General Setup \(GENERAL\)](#)

In-Car Receiver

DSX-B700/DSX-B700W/DSX-B710D

Firmware Update Operation

FILE ERROR: The updater is not stored in the USB device.

- Store the updater in the USB device, then try again.

UPDATE ERROR PRESS ENTER: Firmware update is not completed properly.

- Press ENTER to clear the message, then try again.
During the update, do not turn the ignition to the OFF position, nor remove the USB device.
-

Related Topic

- [Updating the Firmware](#)

In-Car Receiver
DSX-B700/DSX-B700W/DSX-B710D

Customer Support Websites

You can access the following customer support websites to get support information about your system.

For customers in the USA/Canada/Latin America:

<https://www.sony.com/am/support>

For customers in European countries:

<https://www.sony.eu/support>

For customers in other countries/regions:

<https://www.sony-asia.com/support>

For customers in the USA

If you have any questions/problems regarding this product, try the following:

1. Read Troubleshooting in this Help Guide.
2. Please contact (U.S.A. only);
Call 1-800-222-7669
URL <https://www.SONY.com>

For customers in European countries

Register your product online now at:

<https://www.sony.eu/mysony>

In-Car Receiver

DSX-B700/DSX-B700W/DSX-B710D

About the “Support by Sony” App

When you install the “Support by Sony” app on your smartphone, you can get software update information conveniently.

“Support by Sony” app - Find information and get notifications about your product:



- ✓ News & Alerts
- ✓ Software updates
- ✓ Tutorials
- ✓ Tips & Tricks

<https://sony.net/SBS>

Visit the “Support by Sony” website at sony.net/SBS, and bookmark the model name of the unit, “DSX-B700”, “DSX-B700W” or “DSX-B710D”, when you visit the website.