



# Beyond Audio, **HiFi ROSE**

Advanced All-In-One Network Streamer **RS520**



rose

Beyond Audio, **HiFi ROSE**







rose

## Advanced All-In-One Network Streamer RS520

- Reference Grade All-in-One Network Streamer
- Network Streamer + DAC + Class AD Amplifier with next generation GaN FET
- High-Resolution Music Playback available(DSD512, PCM32bit/768kHz)
- A Femto Clock provides Ultra Precision
- The Special Linear Power Supply Configuration minimizes electrical noise

|             |             |                        |                    |               |                               |
|-------------|-------------|------------------------|--------------------|---------------|-------------------------------|
| Hi-Res      | DSD         | Native DSD 512         | In/Out Port        | Speaker       | 2ch 250W(8Ω)                  |
|             | PCM         | 32bit / 768kHz         |                    | USB Audio In  | USB B Type 2.0                |
| In/Out Port | Digital In  | Optical, Coaxial, eARC | Network Connection | USB Audio Out | USB A Type 3.0                |
|             | Digital Out | Optical, Coaxial       |                    | Ethernet      | 10/100/1000 BASE-T            |
|             | Analog In   | Line In                |                    | WiFi          | Optional_dongle (2.4GHz/5GHz) |
|             | Analog Out  | Pre-out_RCA            |                    | Bluetooth     | Optional_dongle               |
|             | HDMI Out    | 4K                     |                    |               |                               |

**Connectivity** Bluetooth, DLNA, Airplay, Spotify Connect, Roon Ready

**Design** 346\*328\*127mm / 8.1 kg / 12.6" Wide viewing angle touch screen / Color : Black, Silver



## Integrated Amplifier - With Gallium Nitride Amplifier built in RA180

- Class AD Amplifier with next generation GaN FET
- Multi Output Component
- Designed to play up to the Super Twitter Realm
- Balanced Power Supply
- PHONO Amplifier with Variable EQ

|             |                   |   |
|-------------|-------------------|---|
| In/Out Port | Analog In         | Line1, Line2, Line3(Bypass), Balanced, Phono(MM/MC) |
|             | Analog Out        | Sub Woofer  |
| Speaker     | Stereo(A/B)       | 4ch 200W(8Ω)  |
|             | Stereo(A), BTL(B) | Stereo(A): 4ch 200W(8Ω) / BTL(B) : 2ch 400W(8Ω)     |
|             | BTL(A/B)          | BTL(A) : 2ch 400W(8Ω) / BTL(B) : 2ch 400W(8Ω)       |

**Design** 430\*391\*124 mm / 16.7 kg / High Purity Aluminum / Color: Silver



## Complete HiFi Network Streamer RS250A

- Reference Grade All-in-One Network Streamer
- Network Streamer + DAC
- High-Resolution Music Playback available(DSD512, PCM32bit/768kHz)
- A Femto Clock provides Ultra Precision
- The Special Linear Power Supply Configuration minimizes electrical noise

|             |             |                  |                    |               |                                 |
|-------------|-------------|------------------|--------------------|---------------|---------------------------------|
| Hi-Res      | DSD         | Native DSD 512   | In/Out Port        | Headphone Out | 3.5mm                           |
|             | PCM         | 32bit / 768kHz   |                    | USB Audio In  | USB B Type 2.0                  |
| In/Out Port | Digital In  | Optical, Coaxial | Network Connection | USB Audio Out | USB A Type 3.0                  |
|             | Digital Out | Optical, Coaxial |                    | Ethernet      | 10/100/1000 BASE-T              |
|             | Analog In   | Line In          |                    | WiFi          | 802.11 a/b/g/n/ac (2.4GHz/5GHz) |
|             | Analog Out  | Pre-out_RCA      |                    | Bluetooth     | V4.0 / V3.0+HS                  |
|             | HDMI Out    | 4K               |                    |               |                                 |

**Connectivity** Bluetooth, DLNA, Airplay, Spotify Connect, Roon Ready

**Design** 278\*231\*83 mm / 3.2 kg / 8.8" Wide viewing angle touch screen / Color : Black, Silver



## High Performance Network Streamer RS150 Series

- Flagship Network Streamer
- Network Streamer + DAC
- High-tech DAC design for pure sound with low noise and low distortion
- High-Resolution Music Playback available(DSD512, PCM32bit/768kHz)
- A Femto Clock provides Ultra Precision
- The Special Linear Power Supply Configuration minimizes electrical noise

|             |             |  |                    |               |                    |
|-------------|-------------|--|--------------------|---------------|--------------------|
| Hi-Res      | DSD         | Native DSD 512                                 | In/Out Port        | HDMI Out      | 4K                 |
|             | PCM         | 32bit / 768kHz                                 |                    | USB Audio In  | USB B Type 2.0     |
| In/Out Port | Digital In  | Optical, Coaxial, AES/EBU, HDMI ARC, USB Audio | Network Connection | USB Audio Out | USB A Type 3.0     |
|             | Digital Out | Optical, Coaxial, AES/EBU, I2S-DVI, I2S-RJ45   |                    | Ethernet      | 10/100/1000 BASE-T |
|             | Analog In   | Line In  |                    | WiFi          | Optional_dongle    |
|             | Analog Out  | Pre-out_XLR, Pre-out_RCA                       |                    | Bluetooth     | Optional_dongle    |
|             |             |  |                    |               |                    |

**Connectivity** Bluetooth, DLNA, Airplay, Spotify Connect, Roon Ready

**Design** 430\*318\*124 mm / 11 kg / 14.9" Wide viewing angle touch screen / Color : Black, Silver



## HiFi Network Streamer RS201 Series

- Reference Grade All-in-One Network Streamer
- Network Streamer + DAC + AMP
- Built-in High-Performance Power Amplifier(50W\*2ch)
- High-Resolution Music Playback available(DSD256, PCM32bit/384kHz)
- A Femto Clock provides High Precision
- Digital equipment, PreAmplifier connection available
- Awarded the world's three major design awards(Reddot, GOOD DESIGN, PIN-UP)

|             |             |                |                    |                                 |                      |
|-------------|-------------|----------------|--------------------|---------------------------------|----------------------|
| Hi-Res      | DSD         | Native DSD 256 | In/Out Port        | Headphone Out                   | 3.5mm                |
|             | PCM         | 32bit / 384kHz | AMP                | USB Out                         | USB A Type 3.0 / 2.0 |
| In/Out Port | Digital In  | Optical        | Network Connection | AMP                             | 50W X 2CH(4Ω)        |
|             | Digital Out | Optical        |                    | Ethernet                        | 10/100/1000 BASE-T   |
|             | Analog In   | Line In        | WiFi               | 802.11 a/b/g/n/ac (2.4GHz/5GHz) |                      |
|             | Analog Out  | Pre-out RCA    | Bluetooth          | V4.0 / V3.0+HS                  |                      |
|             | HDMI Out    | 4K             |                    |                                 |                      |

**Connectivity** Bluetooth, DLNA, Airplay, Spotify Connect, Roon Ready

**Design** 278\*231\*85 mm / 2.3 kg / 8.8" Wide viewing angle touch screen / Color : Silver



## HiFi Media Player RS301

- High-end All-in-One Speaker
- Network Streamer + DAC + AMP + SPEAKER
- 3-Way full-range speaker configuration
- High-Resolution Music Playback available(DSD256, PCM32bit/384kHz)
- Powerful sound playback with dual passive woofer engine design(Patented technology)
- Awarded the world's three major design awards(Reddot, PIN-UP, iF)

**Connectivity** Ethernet, WiFi, Bluetooth, DLNA, Airplay

**Rear** Micro USB, USB A Type, USB B Type, Micro SD, Headphone, AUX

**Design** 360\*122\*119 mm / 1.9 kg / 5" IPS touch panel / Color : Silver



## Premium Media Player RS350

- Casual All-in-One Speaker
- Network Streamer + DAC + AMP + SPEAKER
- 3-Way full-range speaker configuration
- Playback of various file formats available(Music, Video, Image)
- Powerful sound playback with dual passive woofer engine design(Patented technology)

**Connectivity** WiFi, Bluetooth, DLNA, Airplay

**Rear** Micro USB, USB A Type, Micro SD, Headphone

**Design** 364\*123\*123 mm / 1.5 kg / 5" IPS touch panel / Color : White



## HiFi ROSE CD Drive RSA780 Series

- USB-isolator Adopted to block motion noise
- USB-B Type Port Adopted for HiFi Audio
- 900g weight for CD playback without external shaking
- Minimized Motion Noise by applying Insulators
- Provides CD Ripping Features

**Rear** USB B Type

**Design** 152\*152\*25 mm / 0.9 kg / Color : Silver





# Innovative ROSE OS System



## Spotify Connect

Spotify Connect allows you to play and wirelessly control Spotify music on your ROSE OS over a network. With the Spotify Connect function, you can enjoy a variety of music with HiFi sound quality on your ROSE device.



## Hi-Res Audio

HiFi ROSE devices are certified with a 'High-Resolution Audio' license from the JAS (Japan Audio Society).



## TIDAL

Enjoy music streaming and videos with TIDAL's unique features. Supports MQA full decoding, so you can enjoy TIDAL Masters catalogue.



## 4K Video

You can enjoy high-definition videos on YouTube, TIDAL, and Bugs, and play video files in various formats.



## Qobuz

Enjoy music streaming with Qobuz's various functions. Support for Hi-Res Audio (24bit/192kHz) means you can enjoy high-resolution music.



## MQA

RS520 includes MQA technology, which enables you to play back MQA audio files and streams, delivering the sound of the original master recording.



## Roon Ready

ROSE OS is fully compatible with Roon Core, with Roon Ready certification in compliance with all requirements of Roon Labs. You can enjoy HiFi sound quality on your ROSE device with the powerful music management capabilities of Roon.



## ROSE Radio

Enjoy Rose Radio, which consists of about 30,000 radio channels from 200 countries around the world. Channels are organized into various categories, and you can easily search for channels with filters of genre/region/language.



## Bugs

Listen to high-resolution music on Bugs. Easily connects existing functions, including login, playlists, and playback.



## ROSE Tube

You can enjoy all content and music on YouTube.



## Radio

Listen to various Internet radio channels from around the world. Keep track of your favorite channels.



## CD Player

Play CDs by connecting an external USB CD-ROM.



## ROSE Podcast

Listen to various podcasts from around the world.



## CD Ripping

Rip CDs by connecting an external USB CD-ROM and save them on a storage device.



## Clock

Various design clock functions are provided, such as alarms and weather information.



## Music Library

Manage your music files under various categories, such as albums, artists, and genres.



## Apple Music App

Enjoy curated playlists divided by Apple Music's own musical tastes. You can enjoy various tracks in Apple Music.



## My Playlist

Create your own playlist. You can also register your friends and share it with them.

---

## ROSE Connect Remote Application

A dedicated Remote App is provided that allows users to conveniently control and smartly manage their ROSE device. The Remote App is supported on various platforms, including the iPhone, iPad, Android phone, and PCs.

---

### Control

You can freely and conveniently control various HiFi ROSE functions wirelessly.

**Control** You can control a variety of functions remotely including Music, ROSE Tube, TIDAL, Qobuz, Bugs, Radio, Podcasts, Apple Music and CD Play.

**Remote** ROSE Connect includes the remote control function.

**Search** You can conveniently search for a variety of music in the Media Library.

---

### Streaming

You can simply and easily play music stored on your phone on your ROSE device. Enjoy a lossless, high-quality streaming service.

---

### Playlist

You can create your own playlist.

Make a playlist on Music and ROSE Tube and check it out at Home - My Music.

---

### Share with Friends

You can share your playlists with your friends or listen to music recommended by them. Communicate with your friends through music.

---

### Media Library

Scan the music in your local memory to organize it into various categories.



# **OWNER'S MANUAL**

RS520 Product User Manual

# Table of Contents

|  |    |
|--|----|
| <b>Safety Precautions</b>  | 14 |
| 1. Warnings  | 14 |
| 2. Precautions   | 15 |
| <b>Components List</b>   | 16 |
| <b>Location / Function of Buttons and Ports</b>  | 17 |
| 1. Front Side of the Product   | 17 |
| 2. Rear Side of the Product  | 18 |
| 3. Remote Control  | 19 |
| <b>How to Install the Product</b>  | 20 |
| 1. Intended Product Design and Recommended Installation Location   | 20 |
| 2. How to Connect the Power Cord   | 21 |
| 3. How to Properly Connect the Rear Ports and Cables   | 22 |
| 3-1. How to Connect the Analog Output Port to a Power Amplifier or AV Receiver   |    |
| 3-2. How to Connect the Analog Input Port to Audio Device  |    |
| 3-3. How to Connect the Analog Input/Output Port to Audio Device<br>(TV or Devices That Provide Digital Input/Output Capabilities) |    |
| 3-4. How to Connect USB Audio Output Port to External DAC  |    |
| 3-5. How to Connect USB Audio Input  |    |
| 3-6. How to Connect eARC Input   |    |
| 3-7. How to Connect to HDMI Output   |    |
| 3-8. How to Connect Trigger Input/Output to IR Receiver  |    |
| 3-9. How to Connect Speaker L/R Output   |    |
| 4. External Memory (USB Flash Drive) and SATA Storage Devices  | 32 |
| 5. How to Connect SSD  | 33 |
| 5-1. How to Insert SSD   |    |
| 5-2. How to Format After Installing SSD  |    |
| 5-3. How to Copy Files Through the Network   |    |
| 6. Network Connection  | 35 |
| 6-1. Ethernet Connection (Wired)   |    |
| 6-2. WiFi Connection (Wireless)  |    |
| 7. How to Pair with the Bluetooth Remote Control   | 37 |
| 8. How to Connect to RoonReady   | 37 |
| <b>Default Settings</b>  | 39 |
| 1. Power Button  | 39 |
| 2. Input / Output Settings   | 39 |

- 2-1. Input
  - 2-1-1. RS520
  - 2-1-2. LINE IN (L/R)
  - 2-1-3. COAX IN
  - 2-1-4. OPT IN
  - 2-1-5. USB IN
- 2-2. OUTPUT
  - 2-2-1. USB DAC
    - 2-2-1-1. MQA Type
    - 2-2-1-2. PCM Resampling Frequency
    - 2-2-1-3. DSD Mode
    - 2-2-1-4. Software Volume Control
    - 2-2-1-5. How to Calibrate the Lower 8 Bits of a 32-bit Sound Source
    - 2-2-1-6. OUTPUT Gain
  - 2-2-2. HDMI
    - 2-2-2-1. PCM Resampling Frequency
    - 2-2-2-2. DSD Mode
    - 2-2-2-3. HDMI Passthrough
    - 2-2-2-4. Software Volume Control
    - 2-2-2-5. How to Calibrate the Lower 8 Bits of a 32-bit Sound Source
    - 2-2-2-6. OUTPUT Gain
  - 2-2-3. Digital
    - 2-2-3-1. MQA Type
    - 2-2-3-2. PCM Resampling Frequency
    - 2-2-3-3. DSD Mode
    - 2-2-3-4. Software Volume Control
    - 2-2-3-5. How to Calibrate the Lower 8 Bits of a 32-bit Sound Source
  - 2-2-4. Unbalanced (L/R)
    - 2-2-4-1. Pre-Out Level Settings
    - 2-2-4-2. Software Volume Control
    - 2-2-4-3. How to Calibrate the Lower 8 Bits of a 32-bit Sound Source
    - 2-2-4-4. FIR Interpolation Filter
    - 2-2-4-5. PCM Resampling Frequency
    - 2-2-4-7. DSD Mode

**Playback** \_\_\_\_\_ 53

**1. Default Playback** \_\_\_\_\_ 53

**2. Media Library** \_\_\_\_\_ 53

- 2-1. Activate Media Scanning
- 2-2. After Media Scanning

**Supplementary Information** \_\_\_\_\_ 55

**1. Firmware Update** \_\_\_\_\_ 55

- 1-1. How to Run OTA Update
- 1-2. Update Via Settings Menu
- 1-3. How to Install the Firmware When the XMOS/Audio MCU Update Pop-Up Occurs

**2. MQA (Master Quality Authenticated)** \_\_\_\_\_ 59

**3. Factory Reset** \_\_\_\_\_ 59

**Product Specifications** \_\_\_\_\_ 60

**1. Specifications** \_\_\_\_\_ 60

**2. Analog Audio Specifications** \_\_\_\_\_ 61

**Warranty** \_\_\_\_\_ 62

**FAQ** \_\_\_\_\_ 63

# Safety Precautions

## 1. Warnings

---







- Do not apply excessive force to the product, throw it, or impact it with a sharp object.
- When used by children, a parent or guardian should tell them how to use the product correctly and make sure that they are using it correctly.
- Use within a temperature range of 0 - 40 °C and do not use in hot or humid conditions. Install the product in a well-ventilated area, not an enclosed space. The product may break, corrode, overheat, or catch fire in an environment below 0°C or in a sealed environment with a high temperature, such as a sauna. Moisture or liquid can also damage the surface of the product and its circuit components.
- Be sure to use a genuine power cable provided by ROSE. Any other cable may cause operational errors or damage (decreased performance) to the product.
- Do not spill dirt or liquid on the product. It may damage the components and circuits. If the product gets wet, do not turn it on. Contact your nearest service center. However, free repairs are not available in this case.
- Do not connect antennas or accessories that are not certified by ROSE to the product, and do not place the product on objects that may interfere with radio waves (steel desk, microwave oven, etc.).
- The product is sensitive to radio waves, so performance may deteriorate when used around steel, electromagnetic wave devices, etc.
- How to replace the fuse: After removing the power cord from the main body, remove the fuse and replace it with a fuse of the same specification.
- The label for this product is located on the bottom of the product.

## 2. Precautions

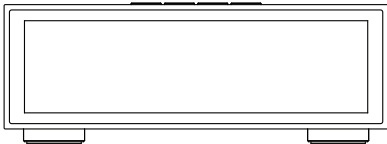
---

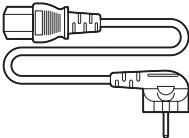
- The contents of the owner's manual are described based on the default settings of the product.
- Some contents of this manual may be changed without prior notice to the user in order to improve product performance.
- The features and additional services of the product may vary depending on the country, software specifications, and policy changes of the service provider.
- Repairs due to user negligence or product failure may erase user data (music files, video files, etc.). ROSE is not responsible for any damage or loss of data.
- If you use Bluetooth and 2.4GHz band wireless LAN together, the WiFi connection may be slow or audio playback through Bluetooth may not work properly due to signal interference. If you are using them at the same time, it is recommended to use wireless LAN connections in the 5GHz band.
- Do not use chemical solutions (alcohol, thinners, solvents, etc.) or detergent to clean the product. Rubbing the product with a chemical solution can create heat and cause the product to catch fire. When cleaning the product, wipe it with a soft cloth or towel.
- Do not disassemble, modify or repair the product on your own. If you do, you will no longer qualify for free repairs. If a malfunction occurs because of this, contact an authorized service center for repairs.
- Only programs provided by the manufacturer are available. Transferring independently created files or user-modified files to the product can cause operational errors or cause serious problems with the product. ROSE is not responsible for any problems that arise in this case.
- If the touch screen is damaged, do not touch it with your hands. Contact the service center immediately, as it may cause injury.
- Install the product close to an outlet so that it is easy to remove the plug from the outlet.
- For HDMI and USB cables, it is recommended to purchase certified products. Otherwise, a connection error may occur, which may cause problems with the audio and output screens. Also, if you are using an HDMI cable extension, be sure to connect it using the HDMI repeater (signal amplifier) device.

# Components List

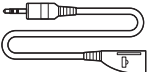
|   |                                  |   |
|---|----------------------------------|---|
| 1 | Main Device                      |    |
| 2 | Bluetooth Remote Control         |    |
| 3 | Power Cable                      |    |
| 4 | User Manual                      |    |
| 5 | SSD Mounting Screws              |  |
| 6 | AAA Batteries for Remote Control |  |
| 7 | External IR Receiver             |  |



# Location / Function of Buttons and Ports

## 1. Front Side of the Product

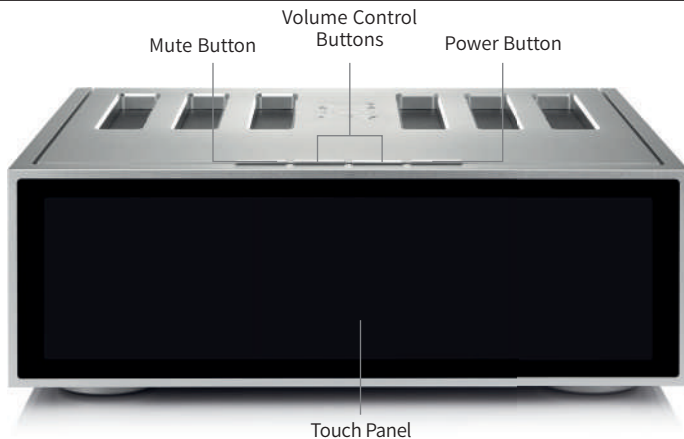

|                               |   |
|-------------------------------|---|
| <b>Power Button</b>           | <ul style="list-style-type: none"><li>· By pressing the power button, you can turn the power on or off and enter or exit standby mode.</li><li>· When the power button is pressed, the ROSE logo is displayed on the LCD screen within 5 seconds and the home screen is displayed when the boot is complete.</li></ul> <p>※ For detailed functions, refer to <i>Initial Settings – Power Button (page 39)</i></p> |
| <b>Volume Control Buttons</b> | <p>You can adjust the volume level by pressing the volume +/- buttons. Volume can be adjusted from 0 to 99 in 100 steps.</p> <p>⚠ <b>Caution:</b> Please note that listening to music at high volume for a long time may cause hearing damage.</p>  |
| <b>Touch Panel</b>            | <p>You can move the screen by touching it several times.</p>  |
| <b>Mute Button</b>            | <p>You can disable/enable the sound by pressing the mute button.</p>  |

## 2. Rear Side of the Product

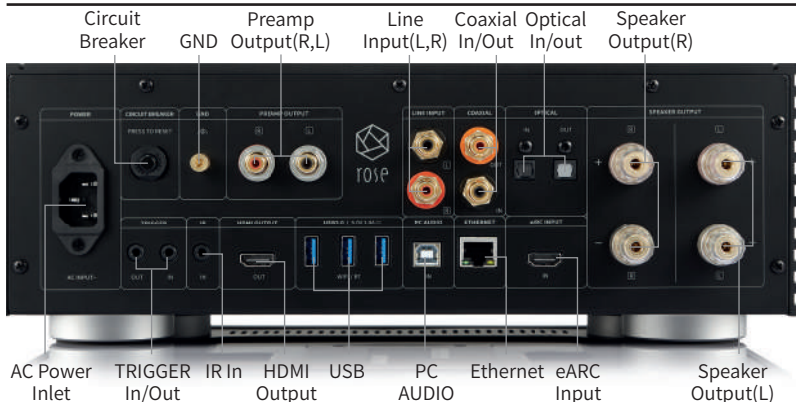

|                            |   |  |
|----------------------------|---|--|
| <b>AC Power Inlet</b>      | <b>AC INPUT ~</b>   | Connect the AC power cable here.   |
| <b>Circuit Breaker</b>     |  | A power circuit breaker is employed to improve the conductivity of the input electricity, and the resolution of the sound quality is improved by securing a wide passage for the input electricity.  |
| <b>GND</b>                 |   | This is a port that connects the external device to the ground.  |
| <b>USB Audio In</b>        | -   | You can use this product as a USB DAC of your computer after connecting the PC audio port on the back to the computer using a USB type B cable.  |
| <b>Optical In</b>          | -   | Connect the optical cable to this port to receive digital signals (44.1 - 192 kHz).  |
| <b>Optical Out</b>         | -   | Connect the optical cable to this port to output digital signals (44.1 - 192 kHz).   |
| <b>Speaker Output(L/R)</b> |   | It is composed of 2ch stereo and outputs 250 W (8 Ω) for each channel.   |
| <b>Analog In</b>           | -   | Connect the RCA cable to this port to receive analog signals (Max: 9.0 dBu / 2.2 Vrms).  |
| <b>Analog Out</b>          | -   | Connect the RCA cable to this port to output analog signals (Max: 9.0 dBu / 2.2 Vrms).   |
| <b>Ethernet</b>            | -   | Connect the LAN cable to this port.  |
| <b>USB 3.0</b>             | 5V 1.0A =<br>USB 3.0  | You can connect a USB storage device to play music files, or connect a CD-ROM to use the ripping function.   |
| <b>HDMI</b>                | -   | You can connect the HDMI cable to play the video output (up to 3840x2160 / 60 Hz) signal on your TV or monitor.  |
| <b>eARC</b>                |   | Connect the eARC output (HDMI) port of the TV to the eARC input (HDMI) port of this device.  |
| <b>Coaxial In</b>          | -   | Connect the coaxial cable to the terminal to receive digital signals (44.1 - 192 kHz).   |
| <b>Coaxial Out</b>         | -   | Connect the coaxial cable to the terminal to output digital signals (44.1 - 192 kHz).  |
| <b>Trigger Input Port</b>  | -   | This is a function that automatically turns on the set without operation through the remote control when DC 3.3 - 12 V power is supplied from an external device.<br><b>( Caution: It will be switched back on when the trigger input for this set is powered off with power applied. Be sure to turn off the power of the external device as well.)</b> |
| <b>Trigger Output Port</b> |   | After pressing the power button on this set, the DC 12 V power is output as a trigger out at the time the main screen booting is completed.<br>(This function is for synchronizing power with external devices.)   |
| <b>IR In</b>               |   | Connect the external IR cable to the IR IN port of this product, and place it in a place where remote control reception is well received.  |

## 3. Remote Control

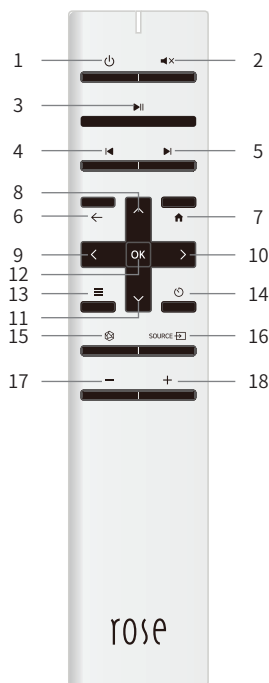

|    | Function                         | Note   |
|----|----------------------------------|--|
| 1  | Power On/Off                     | Sleep Mode On/Off  |
| 2  | Mute                             |  |
| 3  | Play / Pause Current Song        |  |
| 4  | Play Previous Song               |  |
| 5  | Play Next song                   |  |
| 6  | Go Back                          |  |
| 7  | Go to the Home Screen            |  |
| 8  | Move Focus Up                    |  |
| 9  | Move Focus Left                  |  |
| 10 | Move Focus Right                 |  |
| 11 | Move Focus Down                  |  |
| 12 | Select Current Focus             |  |
| 13 | Option Key                       | Works only when playing songs and videos with sub-options (favorite, queue, subscribe) in the list |
| 14 | Sleep Timer                      |  |
| 15 | Go to Favorites Menu             | Go to the favorites menu set on this device  |
| 16 | Go to External Input/Output Menu | Go to Input/Output page  |
| 17 | Volume Down                      | Press and hold to adjust the volume down   |
| 18 | Volume Up                        | Press and hold to adjust the volume up   |

※ The battery life of the Bluetooth remote control is about 3 - 4 months on average, and if the power is low due to battery consumption, the Bluetooth remote control may malfunction. In this case, replace the battery before use.

# Product Installation

## 1. Intended Product Design and Recommended Installation Location

- This product is designed to be used on a table or shelf.
- This product can malfunction during cold or hot weather. (Operating temperature: 0 to 40°C, Storage temperature: -10 to 50°C)
- If the product is installed in a small space, be sure to provide adequate ventilation. A longer operating life is ensured when electronics are properly ventilated and maintained so that they do not overheat more than necessary. Do not install this product directly on a device that generates a lot of heat, such as a power amplifier.
- The figure below shows the minimum ventilation requirements required for the product.
- Keep a space of at least 2.5 cm on each side of this product to prevent airflow from clogging.
- Secure a depth of 35 cm for airflow and cabling.

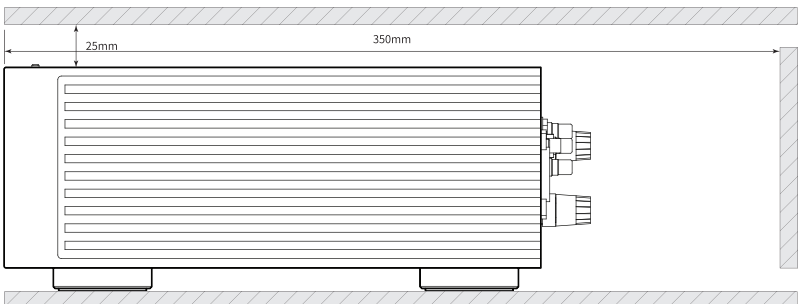
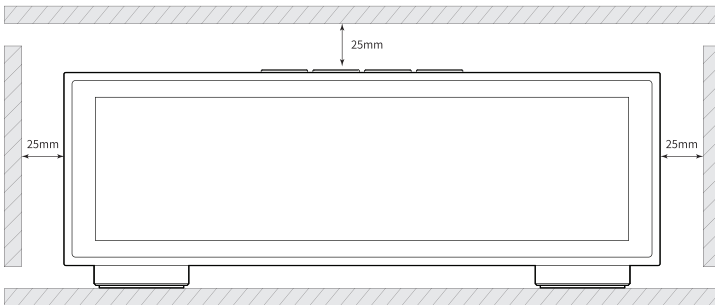

## 2. How to Connect the Power Cord

- This product includes a removable power cord. Please connect the power cord after all connections are complete. Connect the power cord to the AC inlet port of the product first and then connect the power cord to a wall outlet.

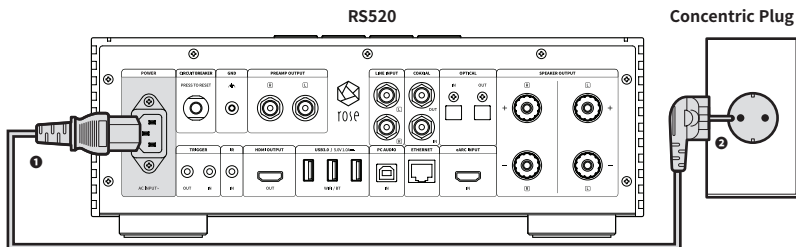

**⚠ Caution :** Always disconnect the power cord from the outlet side first

# 3. How to Properly Connect the Rear Ports and Cables

## 3-1. How to Connect the Analog Output Port to a Power Amplifier or AV Receiver

- As shown in the figure below, the analog audio output of this product can be connected to the analog input of a power amplifier or AV receiver.
- The analog audio output volume adjustment for this product can be selected as “Variable” and “Fixed” through the pre-out level settings.

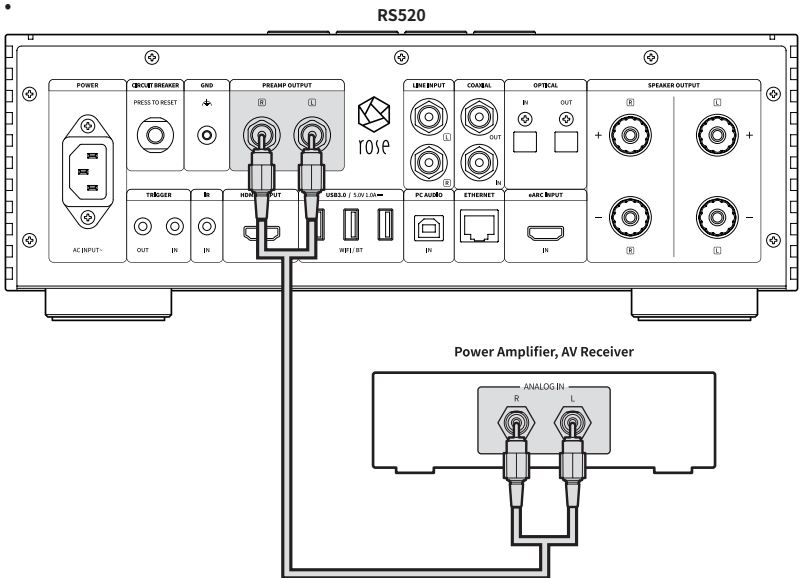

**⚠ Caution:** Before connecting this product to a power amplifier, set the volume of this product to mute or to level 5 or lower and then connect using an RCA cable. If the product is playing music and the volume is turned up, a loud shock sound may be produced when the cable is connected.

## 3-2. How to Connect the Analog Input Port to Audio Device

- As shown in the figure below, you can connect the analog output of an external device such as a CD player to the analog line audio input of this device.
- When using an analog audio input as a source, you must switch the input source to ANALOG IN in the Input/Output Settings. You can change the input/output settings from the home screen, settings, settings on the Rose Connect app, and the remote control.

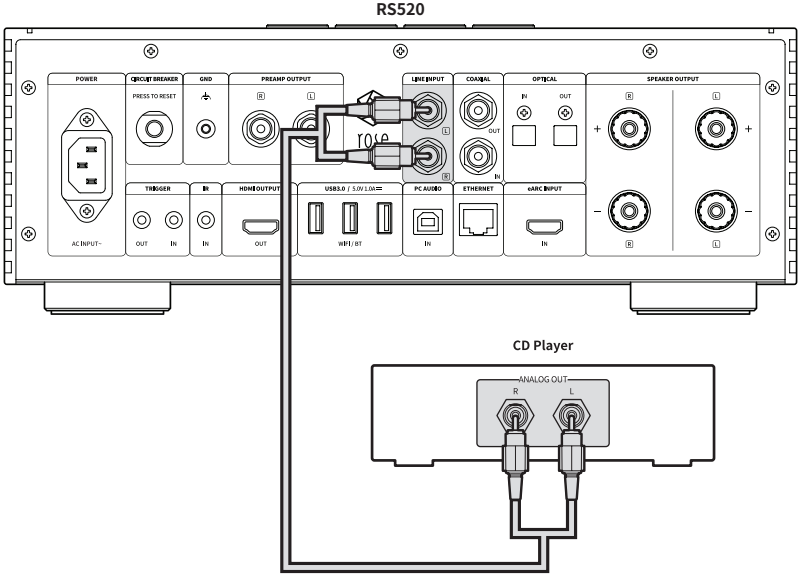

### 3-3. How to Connect the Analog Input/Output Port to Audio Device (TV or Devices That Provide Digital Input/Output Capabilities)

- As shown in the figure below, you can connect the digital input/output device of an external device to the digital (optical/coaxial) input/output port of this product.
- This product can reproduce linear PCM signals with sampling frequencies of 44.1, 48, 88.2, 96, 176.4, and 192kHz.
- When using a digital input as a source, you must switch the input source to OPTICAL IN or COAXIAL IN in the Input/Output Settings.
- To export digital output, you must enable the output mode as OPT OUT or COAX OUT in the Input/Output Settings.
- You can change the input/output settings from the home screen, settings, settings in the Rose Connect app, and the remote control.

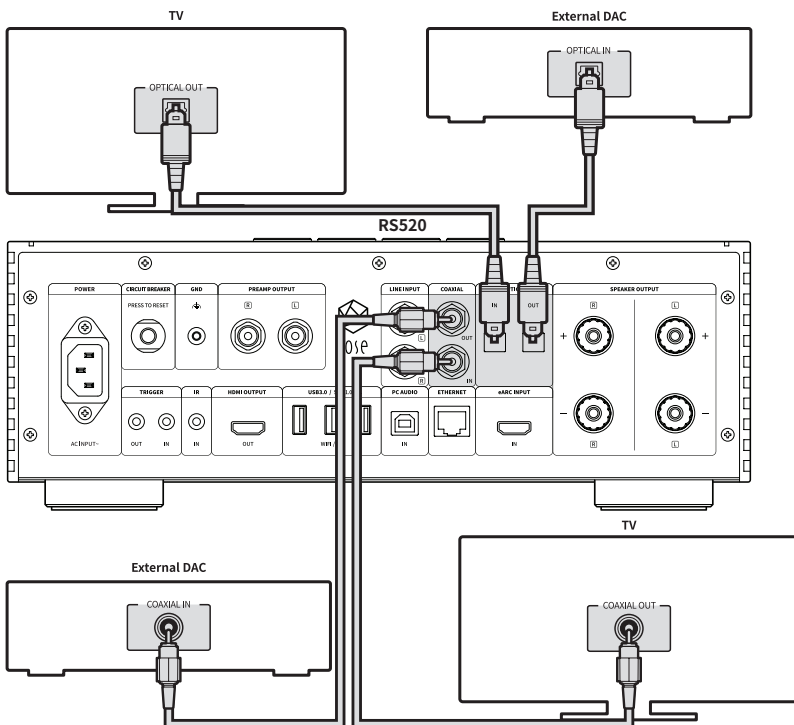



**⚠ Caution:** Do not input signals other than linear PCM signals such as Dolby Digital, DTS, AAC, etc. to this device. Otherwise, noise may be generated and the speaker may be damaged.

### 3-4. How to Connect USB Audio Output Port to External DAC

- You can connect an external DAC to the USB port of this product.
- After connecting the external USB DAC to the USB 3.0 port of this product, you must enable the output device as an external USB DAC in the Input/Output Settings.

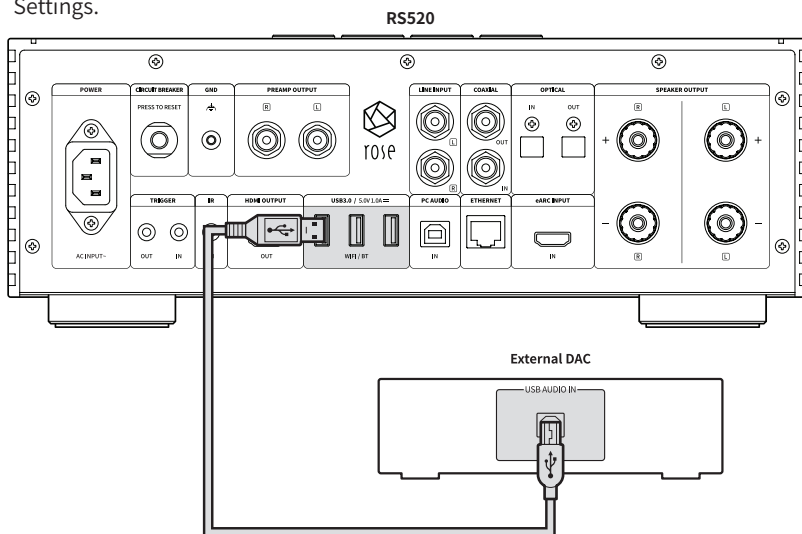

※ This product complies with the USB Audio Class 2.0 specification.

## 3-5. How to Connect USB Audio Input

- Connect the device as shown in the figure below.

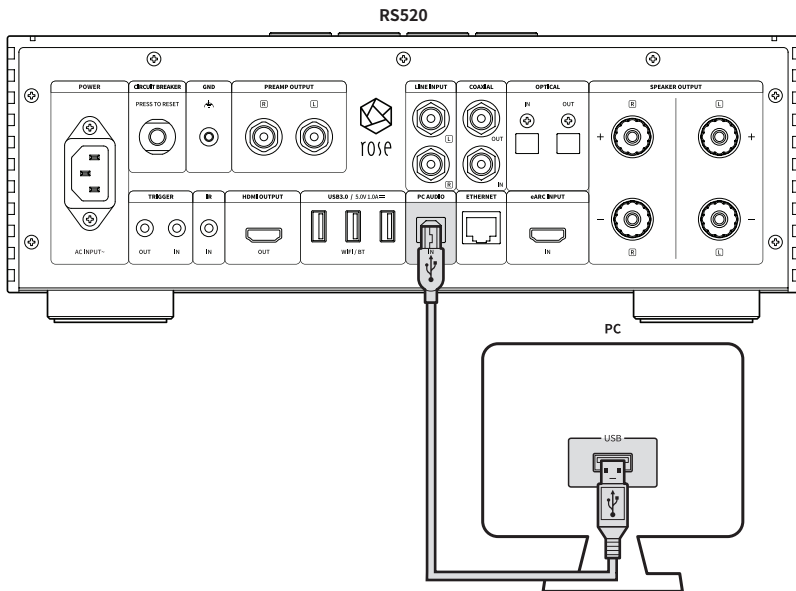

- **3-5-1.** Download Rose\_UsbAudio\_[VERSION] from the ROSE website ([www.hifirose.com](http://www.hifirose.com)).
- **3-5-2.** If you unzip the downloaded Rose\_UsbAudio\_[VERSION] file and run Rose\_UsbAudio\_[VERSION], you will see the following screen. Select Next.

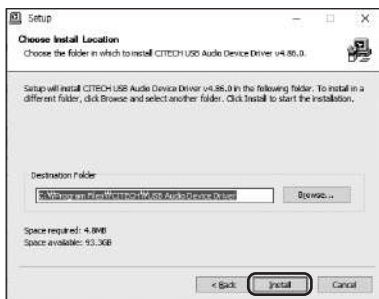

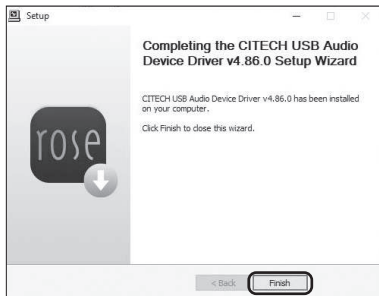
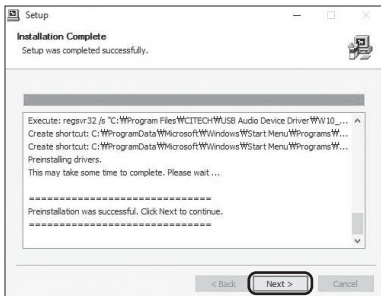

- **3-5-3.** UsReboot after installing UsbAudio sound, universal serial bus controller
- **3-5-4.** After driver installation is complete, if you switch the source to USB input in the Input/Output Settings, RS520-DAC appears on the PC as shown below.

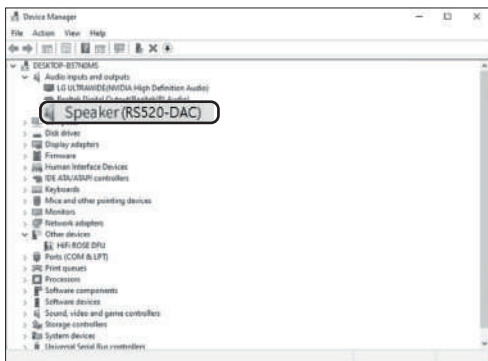

- **3-5-5.** When you set the sound device to RS520-DAC in the system tray area of your PC, you are ready to use the USB input.

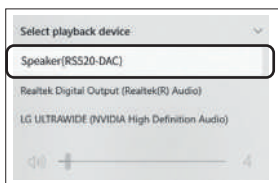

## 3-6. How to Connect eARC Input

- You can connect the TV to the eARC IN (HDMI) port of this product as shown in the figure below.
- When you connect a TV or eARC output external device to the eARC input port of this product, you can output sound through the speaker output or PRE OUT port. When setting the output to the PRE OUT port, you must connect it to the input (LINE INPUT) port of the external amplifier device.
- If the TV does not have an eARC port, please connect it to the ARC port.
- ※ eARC supported audio format: LPCM up to 192kHz / 24 bit (It does not support Dolby and DTS.)

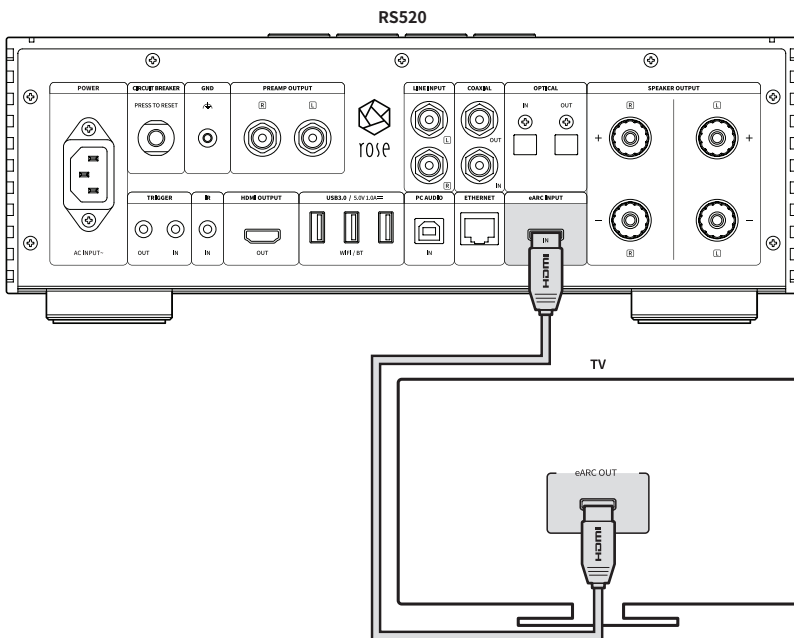

## 3-7. How to Connect to HDMI Output

- As shown in the figure below, you can connect a TV to the HDMI port of this product.
- By connecting this product to a TV, video output (up to 3840x2160 / 60 Hz) signals can be played back.

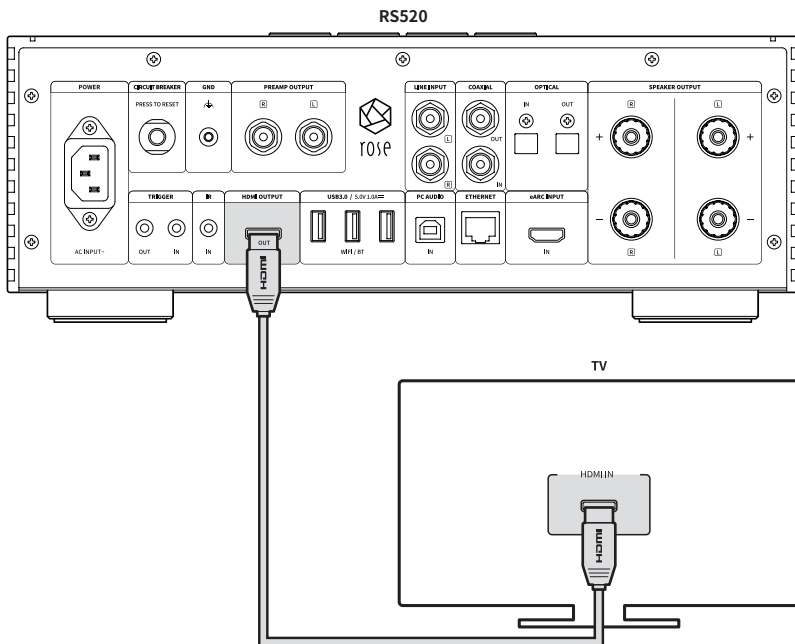

## 3-8. How to Connect the Trigger Input/Output to IR Receiver

### 3-8-1. Trigger Input/Output Ports and Pinouts

- The trigger function can control the power by linking the product and the source device
- If you are using a source device with a trigger output terminal, you can use the trigger function by connecting it to the trigger input port of this product with a monaural mini terminal cable.

**⚠ Caution:** The power available for this product is DC 3.3 - 12 V, so be sure to check the power supply of the external device. Applying power that does not meet the specifications may cause serious damage to the product.

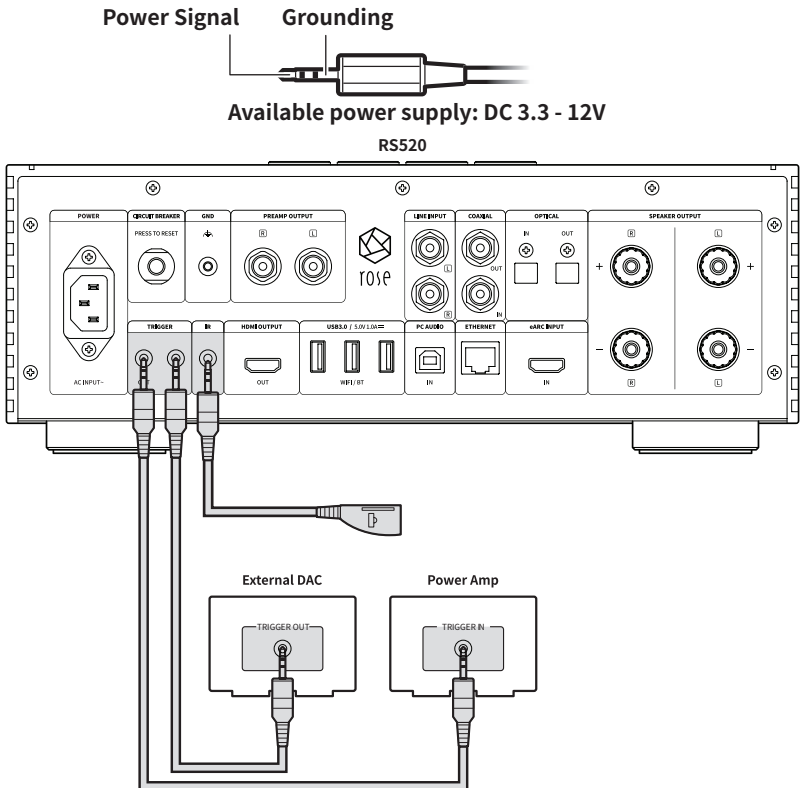

### 3-8-2. External IR Input Terminal and Pinout

- This product does not have an internal IR receiver. After inserting the IR receiver module provided as an accessory into the IR IN port located on the rear side, please place it in a location where remote control reception works well.
- The IR external receiver uses a 3.5 mm stereo mini phone plug. Refer to the following figure for the pinout.

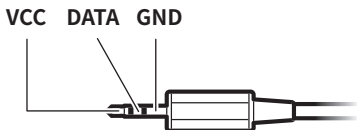

### 3-9. How to Connect Speaker L/R Output

- It is composed of 2ch stereo and outputs a maximum of 250 W (8 Ω) for each channel.
- For the speaker configuration, it is recommended to use 2 full-range speakers, each with 250 W output or more.

※ **Caution** : *outputting loud sound on a low output speaker may cause serious damage to the speaker*

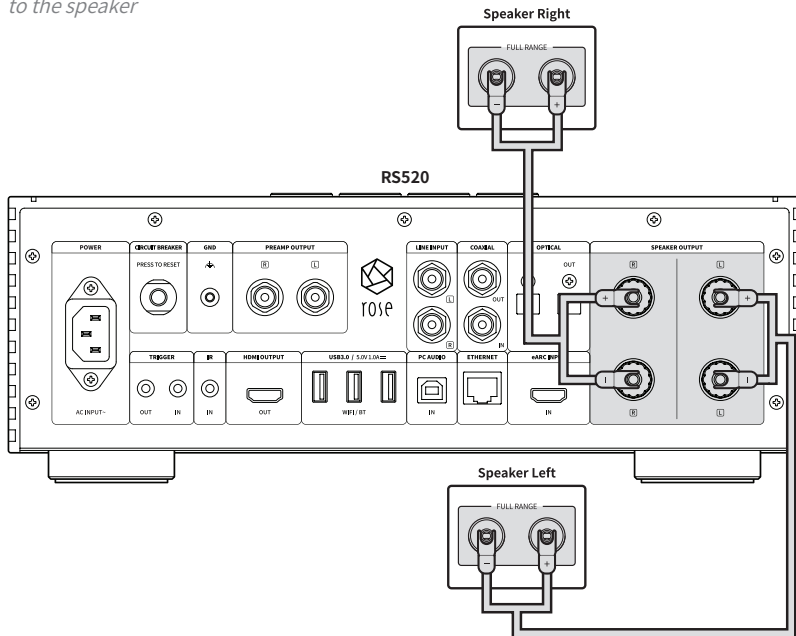

## 4. External Memory (USB Flash Drive) and SATA Storage Devices

---

- You can connect USB and SATA storage devices to this product.
- If you are using SATA to connect storage devices, it is recommended to use an SSD.
- USB storage devices are compatible up to 10TB and SATA storage devices up to 4TB.
  - ※ *SSDs can be purchased separately, and only the 7mm thick standard is available.*
  - ※ *Only Samsung SSDs have been tested for compatibility, and some SSDs (made by Intel) may not work properly.*

## 5. How to Connect SSD

---

### 5-1. How to Insert SSD

---

- **5-1-1.** Remove the screws (2 pcs) from the SSD cover on the bottom of the main body.
- **5-1-2.** Slide the cover in the direction marked OPEN to remove the SSD cover.

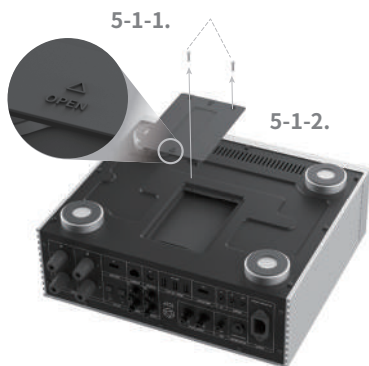



- **5-1-3.** Install the SSD in line with the port on the SSD cover.
- **5-1-4.** Fix the SSD to the SSD cover with the SSD mounting screws (4 pcs).

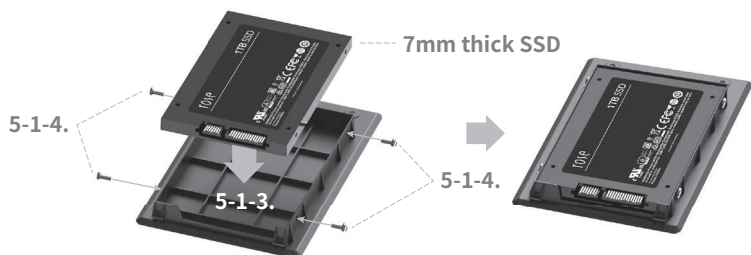

- **5-1-5.** Assemble the SSD cover with the SSD installed on the main body.
- **5-1-6.** Slide the cover in the direction marked LOCK and re-fasten the screws (2 pcs).

5-1-6.

5-1-5.

## 5-2. How to Format After Installing SSD

- You can format the SSD connected to this product in the SSD Format menu in Storage Settings.

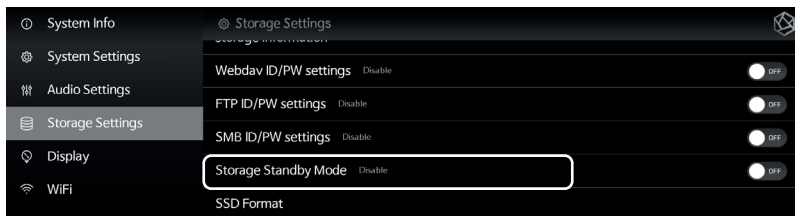

## 5-3. How to Copy Files Through the Network

- Set SMB ID/PW in Storage Settings.

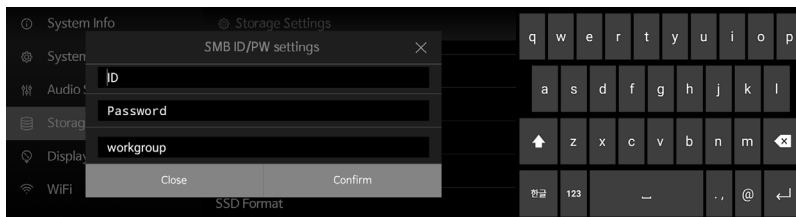

- After entering \\Rose IP on your PC, enter the ID/PW you set in SMB to view the storage associated with this product and copy files directly from your PC.

※ To connect to SMB of this product from your PC, both devices must be connected to the same network.

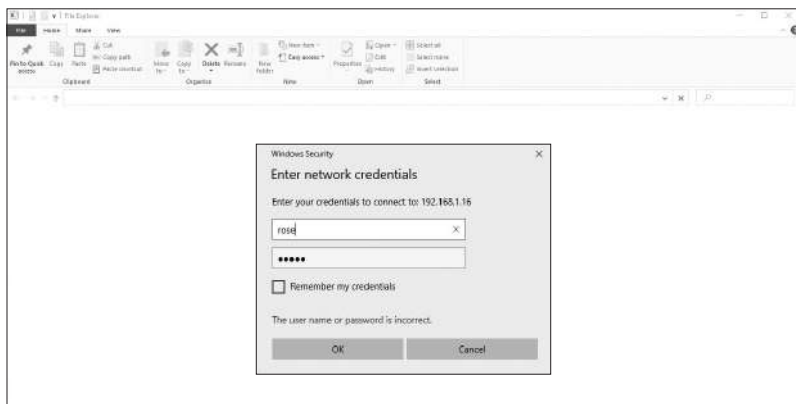
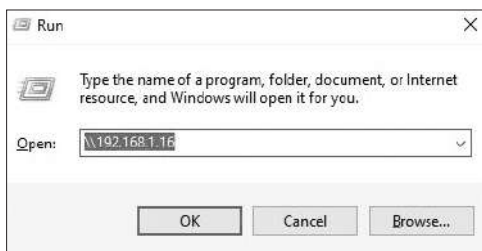

# 6. Network Connection

- This product can connect to wired/wireless networks

## 6-1. Ethernet Connection (Wired)

- After connecting the LAN cable to the rear Ethernet port, select ON in the Settings - Ethernet menu to connect to the network.
- If connected normally, the IP address and other information are automatically obtained.

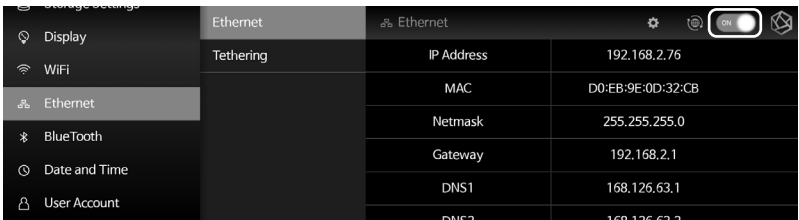

- **6-1-1.** After Ethernet connection, you can use this product for Wi-Fi tethering. Once you have entered your network name and password and enabled the tethering feature, you can connect to this Wi-Fi tethering using your password on another device.

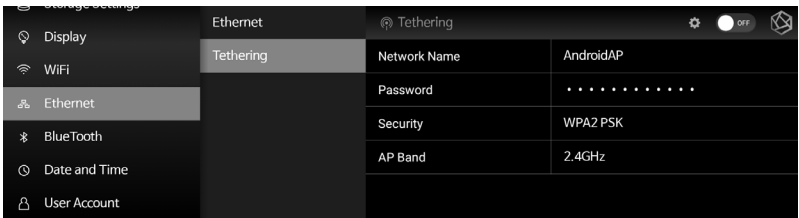

## 6-2. WiFi Connection (Wireless)

- When you turn on the function in the Settings - Wi-Fi menu, the currently available SSID is displayed. Select the desired SSID and connect to the network.

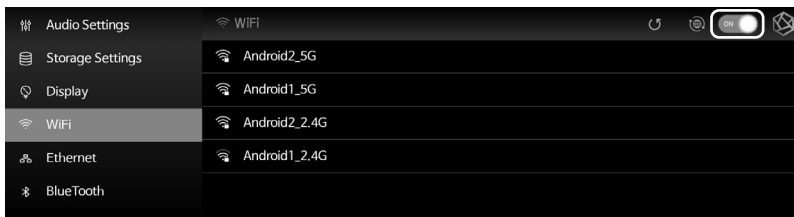

※ You can remotely control this product by installing the ROSE Connect Premium application available on Google Play Store and App Store on your smartphone.

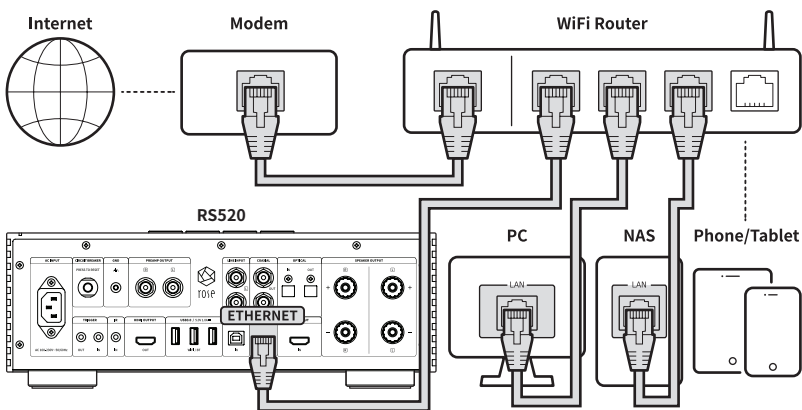

※ To control this product from the mobile application (ROSE Connect Premium), the product and smartphone must be connected to the same network. (You can configure one network by using a wireless network extender, bridge, etc.)

## 7. How to Pair with the Bluetooth Remote Control

- **7-1.** Press the Home (🏠) and Option (⌘) buttons on the remote control at the same time for about 5 seconds.
- **7-2.** When the white LED of the remote control turns on, activate the Bluetooth switch to ON in the Settings - Bluetooth menu on the main device and select Search Peripheral Devices (🔍):
- **7-3.** After selecting ROSE RCU from the Available Device List, if you select ROSE RCU from Registered Devices, the light will change to gold and the pairing is completed

## 8. How to Connect to Roon Ready

- To use Roon, you must first create an account by accessing the website (<http://roonlabs.com>). Download RoonCore and install the software on your PC.
- You can see a variety of music available on RoonCore.

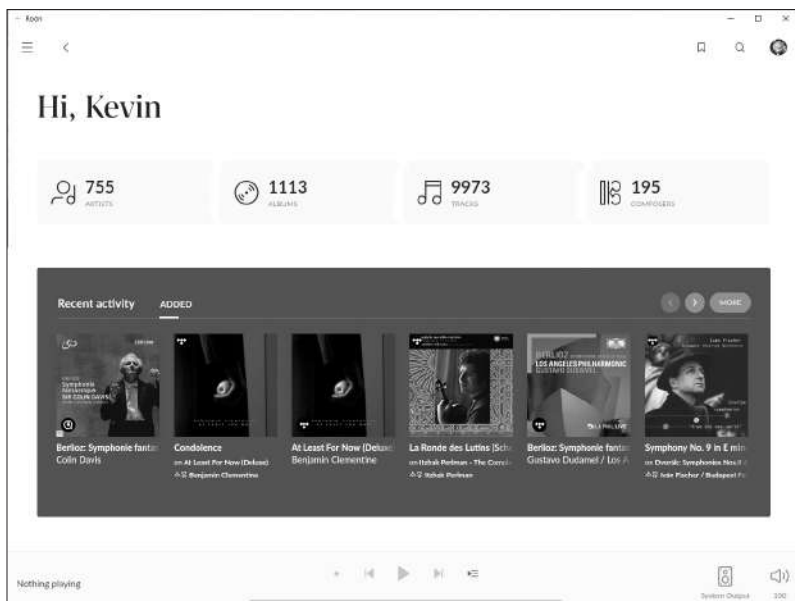

- From Settings - Audio, select this product from Select Audio.

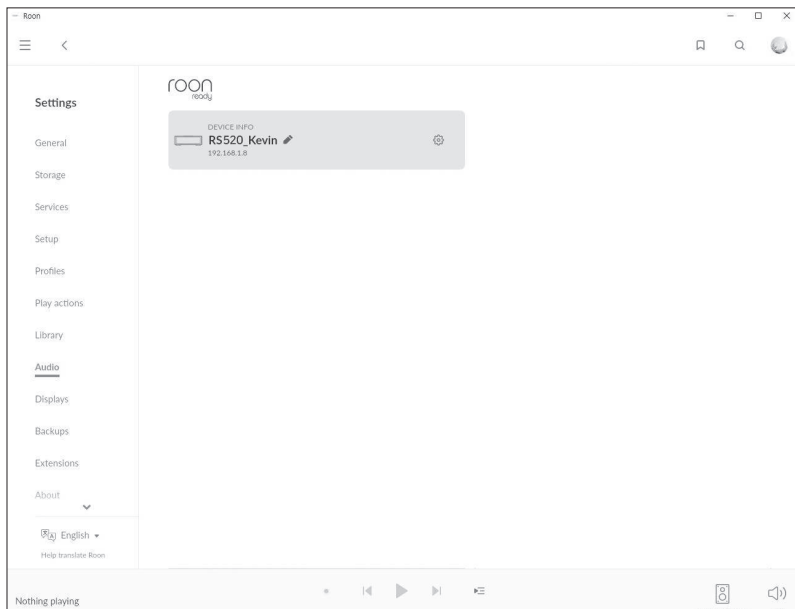

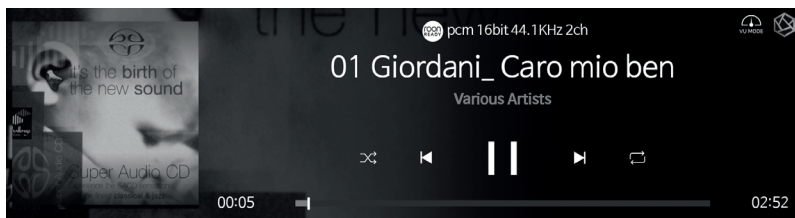

- Once the connection with ROSE is complete, you can control and listen to the music by running the music in Roon.



※ To control this product from Roon, your PC and product must be connected to the same network.

# Default Settings

## 1. Power Button

- **1-1.** You can turn this product on and off by pressing the power button briefly.
  - 1-1-1.** If you press the power button briefly, the product enters standby mode when power is on, and the product is turned on when power is off.
  - 1-1-2.** If you press the power button during booting, the product turns off.
- **1-2.** Press the power button for 3 seconds to display the[LCD OFF|Shutdown|Restart] menu.
  - 1-2-1.** LCD OFF(  ): The sound continues to play and only the screen is turned off. If you press the power button again while the LCD screen is off, the screen turns on.
    - ※ *This function allows you to turn off only the screen while using the product.*
  - 1-2-2.** Shutdown(  ): The system will shut down.
  - 1-2-3.** Restart(  ): Move to the Home screen after turning the product off and on
    - ※ *If you touch anywhere on the screen other than the menu, the command will be canceled.*
- **1-3.** Press the power button for 5 seconds to force a reboot.

## 2. Input / Output Settings

- Tap the Input/Output Settings icon from the main screen to go to the Input/Output Settings menu.

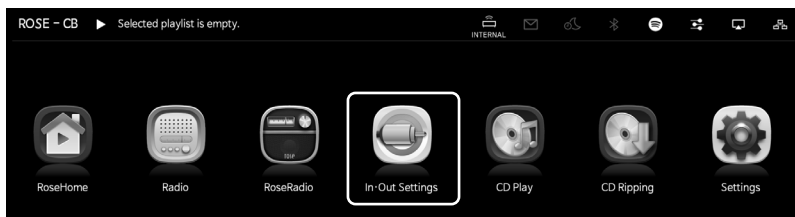

## 2-1. INPUT

---

- You can select the input by tapping the icon in the Input Setting menu. When enabled, this icon changes to a gold color and a check mark appears.

※ *Only one input can be selected at a time.*

### 2-1-1. RS520

---

- Set this product to Internal mode. You can select it when using a storage device or streaming source as the default mode when starting for the first time.
- When an external input is in use, it is automatically selected when playing music from a storage device or a streaming source.



### 2-1-2. LINE IN (L/R)

---

- When using an analog audio input as a source, select LINE IN as the input source in the Input/Output Settings.

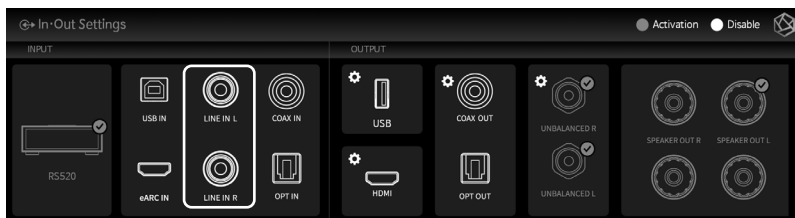



### 2-1-3. COAX IN

- When using the coaxial input as the source, select COAX IN as the input source in the Input/Output Settings.



### 2-1-4. OPT IN

- When using the optical input as the source, select OPT IN as the input source in the Input/Output Settings.



### 2-1-5. USB IN

- When connecting this product to your PC and using it as a USB DAC, select USB IN as the source in the Input/Output Settings.

※ Refer to *How to Install the Product - How to Connect USB Audio Input*.



## 2-2. OUTPUT

- You can enable/disable the output settings by selecting the icon in the Output Settings menu
- When enabled, this icon changes to a gold color and a check mark appears. Only one output among USB, HDMI, and internal DAC can be selected.

### 2-2-1. USB DAC

- If you select USB after connecting a USB DAC, a list of connected USB DACs appears. Select the USB DAC to use from the list.

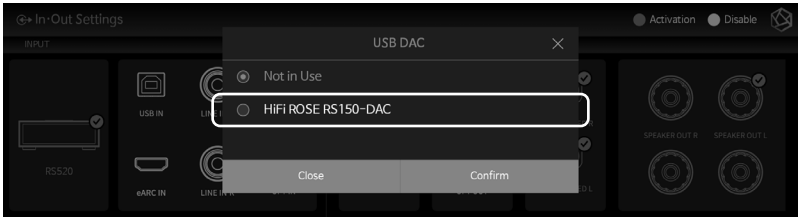

- When USB DAC is selected, the model name of the selected USB DAC appears and becomes available.



- If you select the USB DAC setting icon, the following USB DAC Setting screen appears.

## 2-2-1-1. MQA Type

---

- This is the menu to set the MQA playback mode. You can choose authenticator or decoder mode. Only the original sound or decoded audio data can be exported as digital output, not fully decoded audio data.

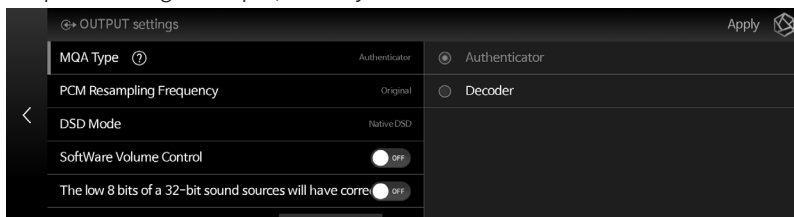

## 2-2-1-2. PCM Resampling Frequency

---

- This is the menu to set the sampling frequency. If you want to output the original sound, select the Original Sampling Rate. If you want to use the resampling function, select the desired sampling rate (48kHz, 96kHz, 192kHz, etc.)

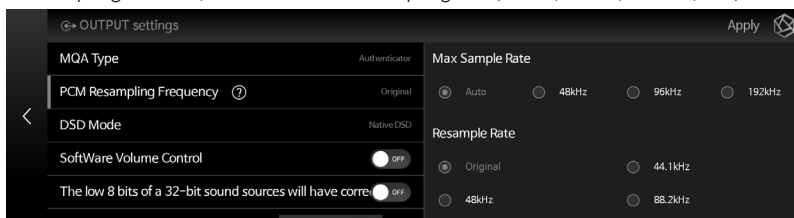

## 2-2-1-3. DSD Mode

---

- This is a menu that determines the transmission format (Native, DOP, PCM) of the audio sample to be delivered to the DAC when playing the DSD sound source. If you select USB DAC, you can play DSD sound sources by selecting Native, DOP, or DSD to PCM depending on whether the connected DAC supports it.

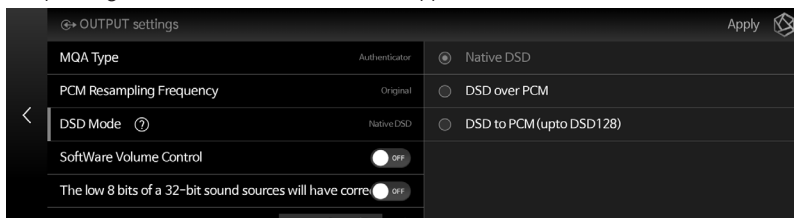

## 2-2-1-4. SoftWare Volume Control

- You can adjust the playback volume of digital audio data using the ROSE Volume Control software.
- **Caution 1.** This function is not available in Native DSD and DSD over PCM mode. It is applied after changing to DSD to PCM (up to DSD128) mode.
- **Caution 2.** For digital output, MQA stream is only supported when the volume is at maximum. If the volume is smaller than the maximum, MQA stream is not supported.

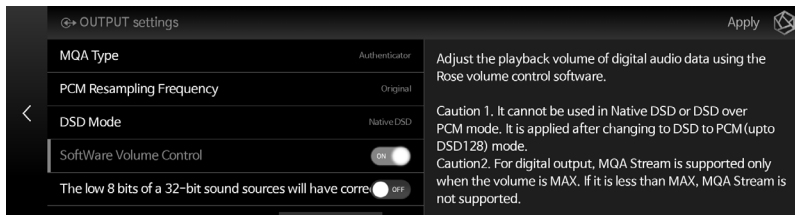

## 2-2-1-5. How to Calibrate the Lower 8 Bits of a 32-bit Sound Source

- Some DACs may cause noise when playing 32-bit sound sources with high sampling rates. In this case, this feature can be used to reduce noise by correcting the lower 8 bits.

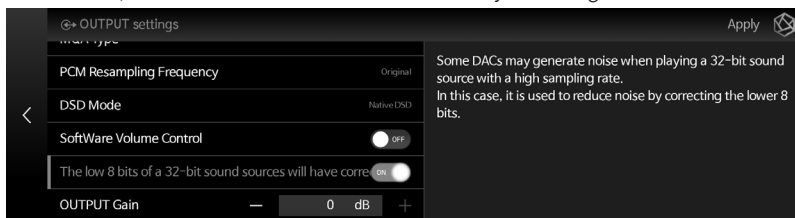

## 2-2-1-6. OUTPUT Gain

- This is a menu to adjust the gain value of the digital output. If distortion occurs when connecting to an external receiver or DAC, adjust the output gain value appropriately.

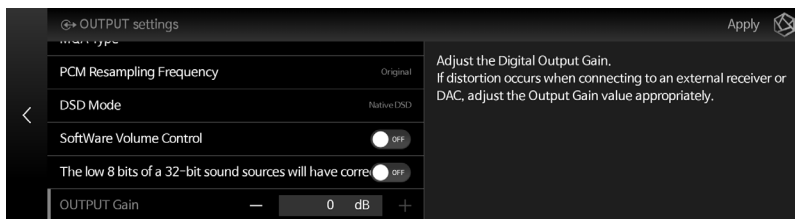

## 2-2-2. HDMI

- This is a menu where you can configure HDMI settings.



- If you select the HDMI Setting icon, the HDMI Setting screen appears as shown below.

### 2-2-2-1. PCM Resampling Frequency

- This is the menu to set the sampling frequency. If you want to output the original sound, select the Original Sampling Rate. If you want to use the resampling function, select the desired sampling rate (48kHz, 96kHz, 192kHz, etc.)

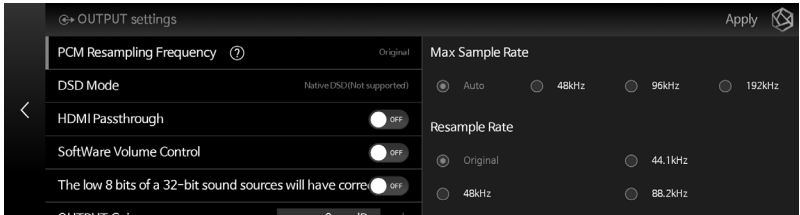

### 2-2-2-2. DSD Mode

This is a menu that determines the transmission format (Native, DOP, PCM) of the audio sample to be delivered to the DAC when playing the DSD sound source. For HDMI output, only DSD to PCM is possible.

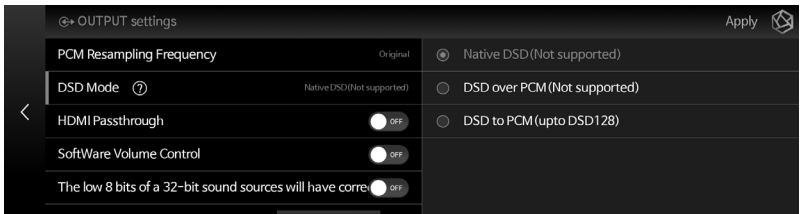

### 2-2-2-3. HDMI Passthrough

- This is a function to bypass HD audio format such as surround sound source to the audio receiver through HDMI without decoding.

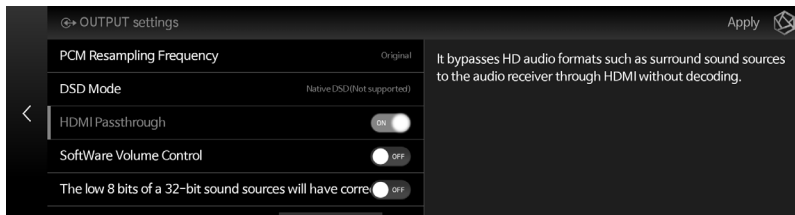

### 2-2-2-4. SoftWare Volume Control

- You can adjust the playback volume of digital audio data using the ROSE Volume Control software.
- **Caution 1.** This function is not available in Native DSD and DSD over PCM mode. It is applied after changing to DSD to PCM (up to DSD128) mode.
- **Caution 2.** For digital output, MQA stream is only supported when the volume is at maximum. If the volume is smaller than the maximum, MQA stream is not supported.

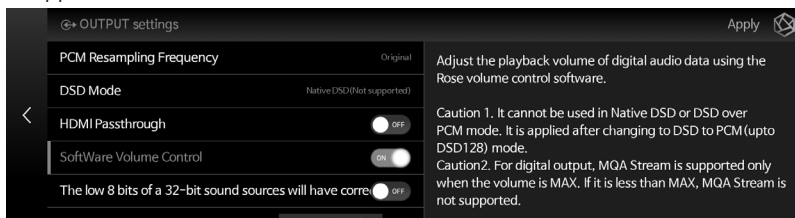

### 2-2-2-5. How to Calibrate the Lower 8 Bits of a 32-bit Sound Source

- Some DACs may cause noise when playing 32-bit sound sources with high sampling rates. In this case, this feature can be used to reduce noise by correcting the lower 8 bits.

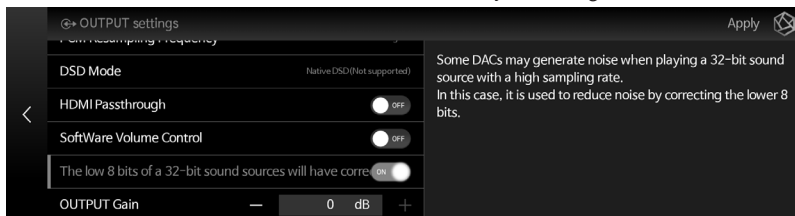

## 2-2-2-6. Output Gain

---

- This is a menu to adjust the gain value of the digital output. If distortion occurs when connecting to an external receiver or DAC, adjust the output gain value appropriately

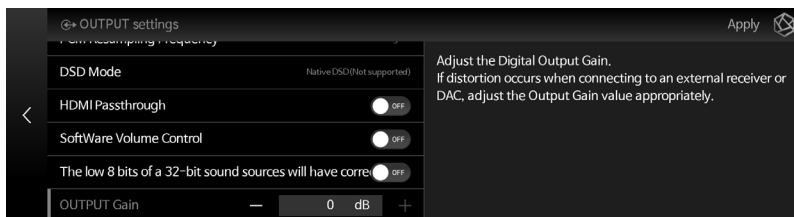

## 2-2-3. Digital

---

- You can configure coaxial output and optical output.



- If you select the digital setting icon, the digital output setting screen appears as follows.

### 2-2-3-1. MQA Type

---

- This is the menu to set the MQA playback mode. You can choose authenticator or decoder mode. Only the original sound or decoded audio data can be exported as digital output, not fully decoded audio data.

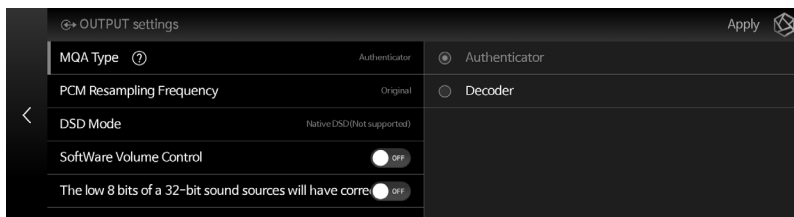

## 2-2-3-2. PCM Resampling Frequency

- This is the menu to set the sampling frequency. If you want to output the original sound, select the Original Sampling Rate, and if you want to use the resampling function, select the desired sampling rate (48kHz, 96kHz, 192kHz, etc.)

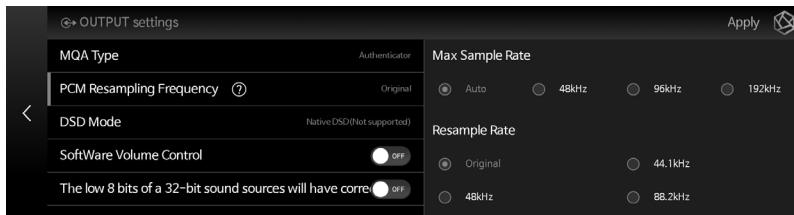

## 2-2-3-3. DSD Mode

- This is a menu that determines the transmission format (Native, DOP, PCM) of the audio sample to be delivered to the DAC when playing the DSD sound source.
- In Native mode, the analog output can play up to DSD512, but the digital output does not produce sound.
- Analog output does not produce sound when set to DOP mode, and only outputs up to DSD64 when set to optical and coaxial modes are supported.
- When set to DSD to PCM mode, only outputs up to DSD128 are supported.

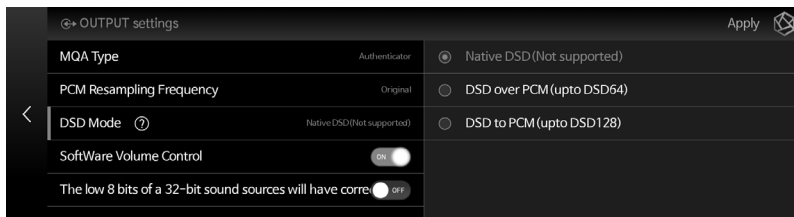



## 2-2-3-4. SoftWare Volume Control

- You can adjust the playback volume of digital audio data using the ROSE Volume Control software.
- **Caution 1.** This function is not available in Native DSD and DSD over PCM mode. It is applied after changing to DSD to PCM (up to DSD128) mode.
- **Caution 2.** For digital output, MQA stream is only supported when the volume is at maximum. If the volume is smaller than the maximum, MQA stream is not supported.

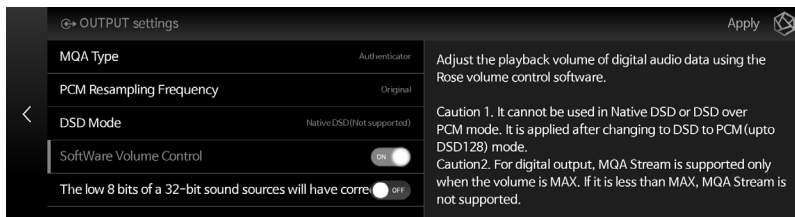

## 2-2-3-5. How to Calibrate the Lower 8 Bits of a 32-bit Sound Source

- Some DACs may cause noise when playing 32-bit sound sources with high sampling rates. In this case, this feature can be used to reduce noise by correcting the lower 8 bits.

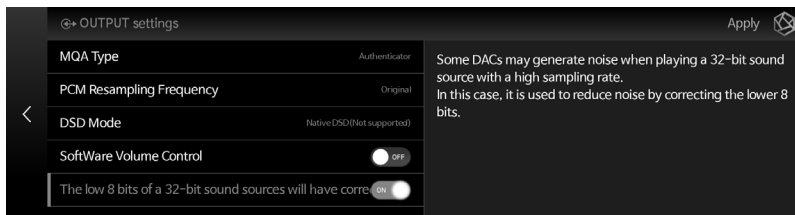

## 2-2-4. Unbalanced (L/R)

- This is a menu to set analog output.



- If you select the analog setting icon, the analog output setting screen appears as follows.

### 2-2-4-1. Pre-Out Level Settings

This is a function of fixing the pre-out output level. Without using this product's volume control function, you can fix the output level of this product with an input within the allowable range of the connected amplifier.

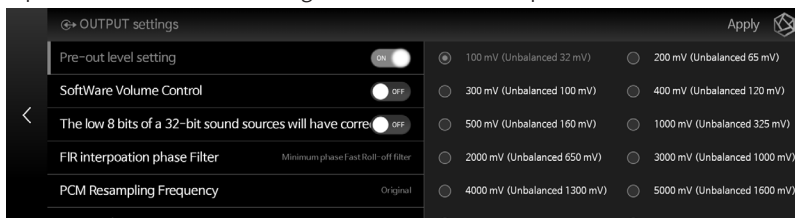

## 2-2-4-2. SoftWare Volume Control

- You can adjust the playback volume of digital audio data using the ROSE Volume Control software.
- **Caution 1.** This function is not available in Native DSD and DSD over PCM mode. It is applied after changing to DSD to PCM (up to DSD128) mode.
- **Caution 2.** For digital output, MQA stream is only supported when the volume is at maximum. If the volume is smaller than the maximum, MQA stream is not supported.

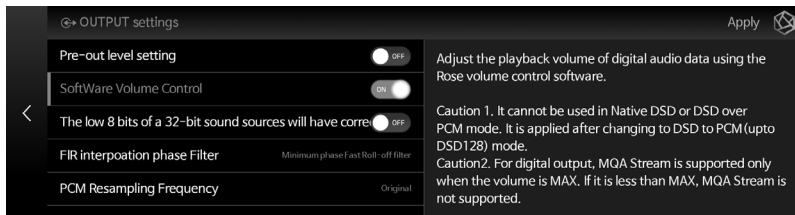

## 2-2-4-3. How to Calibrate the Lower 8 Bits of a 32-bit Sound Source

- Some DACs may cause noise when playing 32-bit sound sources with high sampling rates. In this case, this feature can be used to reduce noise by correcting the lower 8 bits.

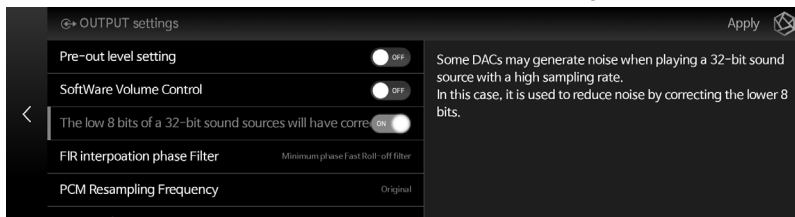

## 2-2-4-4. FIR Interpolation Filter

- Even when the user selects a specific filter, “Minimum phase slow roll-off filter” is automatically selected to provide the best audio quality during MQA playback.
- The FIR filter only applies to PCM data, not to DSD.

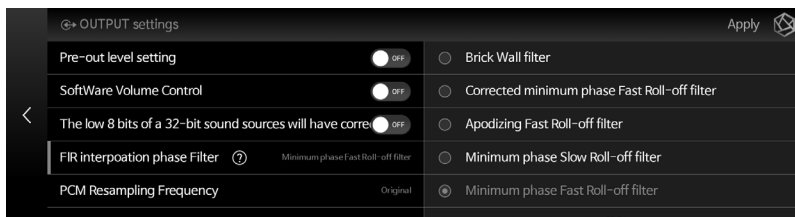

## 2-2-4-5. PCM Resampling Frequency

---

- This is the menu to set the sampling frequency.
- If you want to output the original sound, select the Original Sampling Rate, and if you want to use the resampling function, select the desired sampling rate (48kHz, 96kHz, 192kHz, etc.).

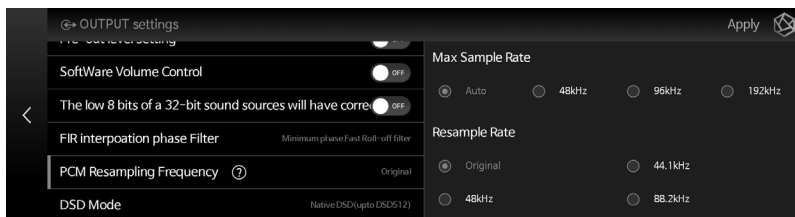

## 2-2-4-6. DSD Mode

---

- This is a menu that determines the transmission format (Native, DOP, PCM) of the audio sample to be delivered to the DAC when playing the DSD sound source.
- In Native mode, the analog output can play up to DSD512, but the digital output does not produce sound.
- Analog output does not produce sound when set to DOP mode, and only outputs up to DSD64 when set to optical and coaxial modes are supported.
- When set to DSD to PCM mode, only outputs up to DSD128 are supported.

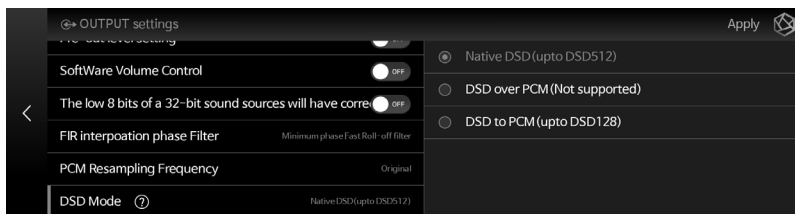

# Playback

## 1. Default Playback

- You can play music and video files by connecting a USB storage device to the USB port on the back of the product.
- SATA HDD/SSD can be installed at the bottom of this product.  
※ *Thickness: 2.5 inch / 7 mm*
- Enter the Music/Video - Folder tab to play the music files in the storage device.

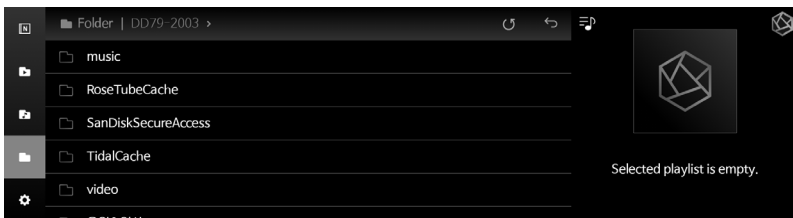

## 2. Media Library

- You can scan sound sources in storage media or network shared folders and save them as a library (DB).

### 2-1. Activate Media Scanning

- When you connect a new storage device to the USB port on the back of the device, a pop-up will appear informing you that the new storage has been detected.

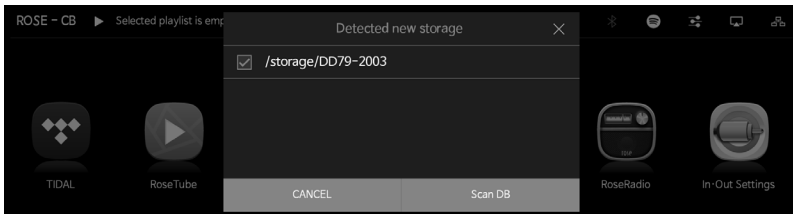

- When you select Scan DB button in the pop-up notifying that new storage has been detected, media scanning for the connected storage device starts. (Depending on storage capacity, media scanning may vary in time.)
- During DB scan, a loading image with “Now analyzing media” is displayed at the bottom left of the main home page of this product.

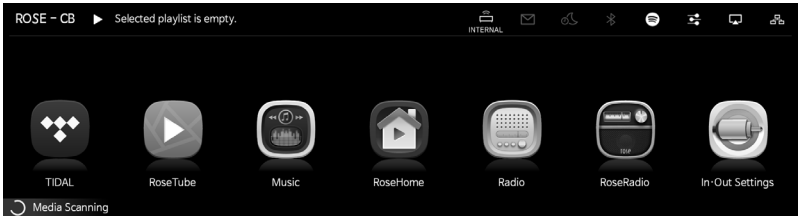

- After DB scan is completed, album art and list of music and video are displayed and can be played.
- You can also add/research/delete DB through the Music/Video and Settings menu.



## 2-2. After Media Scanning

---

- The album list is displayed with album art, and you can play the entire track included in the album.
- You can sort and play by album, artist, genre, composer.
- You can search by the artist or album name you want.
- You can use the Playlist/Favorite feature to save your favorite songs and albums.

# Supplementary Information

## 1. Firmware Update

### 1-1. How to Run OTA Update

- If the latest version of the update is available while connected to the network, a system update pop-up will be displayed.

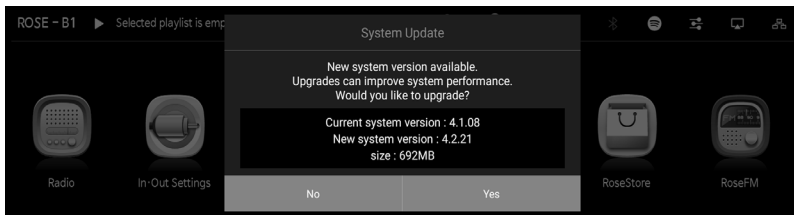

- When you select Yes button in the system update pop-up, the OTA update will proceed

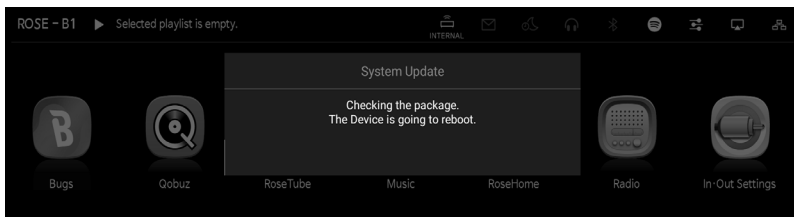
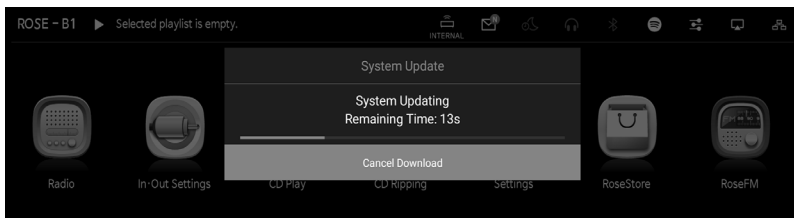

- After rebooting, the software system update is complete.

**⚠ Caution:** Forcibly removing power during an update may cause problems

## 1-2. Update Via Settings Menu

- If a newer version update is available, Update button will be displayed in the system version information in the Settings menu.



- When you select Update button, a system update pop-up is displayed.

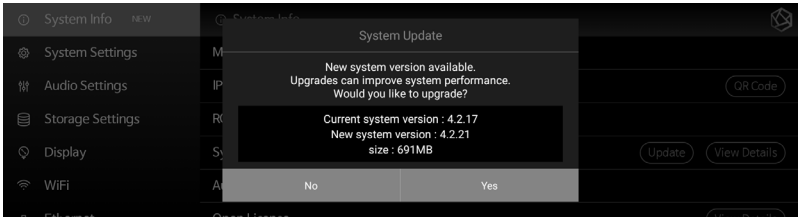

- When you select Yes button in the system update pop-up, the OTA update will proceed.

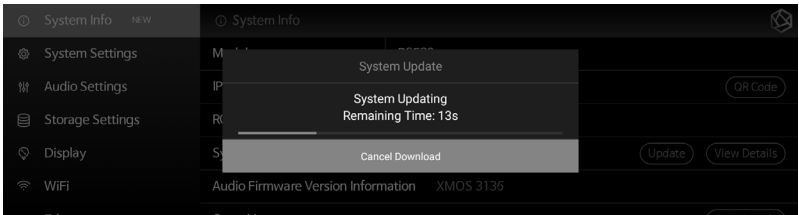

- After rebooting, the software system update is complete.

⚠ **Caution:** Forcibly removing power during an update may cause problems.



## 1-3. How to Install the Firmware When the XMOS/Audio MCU Update Pop-Up Occurs

---

- If there is an XMOS/Audio MCU update after the system update, the update pop-up is automatically disposed and you can proceed with the update.
- Updates can occur in the following cases:

### 1-3-1. When Only XMOS Update Is Available

---

- It automatically reboots after running the XMOS update.

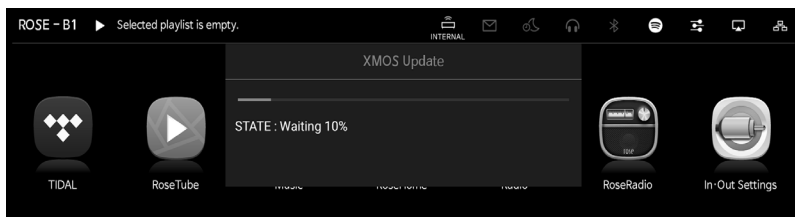

### 1-3-2. When Only Audio MCU Update Is Available

---

- It automatically reboots after running the MCU update.



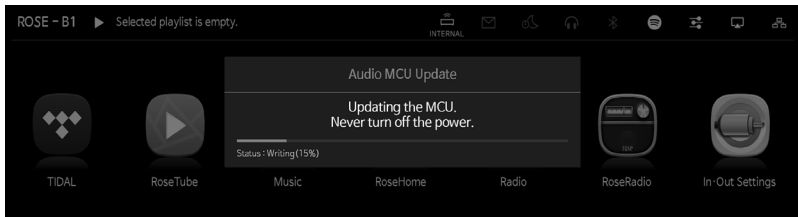

### 1-3-3. When Both XMOS/Audio MCU Updates Are Available

- After completing the XMOS update, the Audio MCU update is automatically executed. It will then automatically reboot.

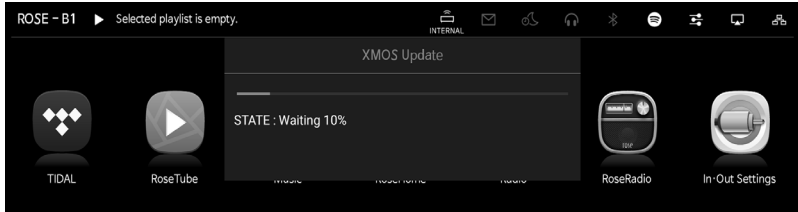
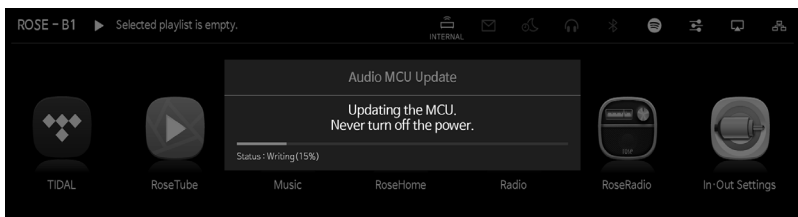

**⚠ Caution:** Do not remove power by force during an update, as this may cause problems.

## 2. MQA (Master Quality Authenticated)

---



- MQA, which delivers the sound of the original master recording, is an award-winning British technology. The master MQA file indicates that it has been duly certified and is available in small enough capacity to stream or download.
- RS520 includes MQA technology, which allows you to play MQA audio files and streams to deliver the sound quality of the original master recording.
- A green or blue dot next to the 'MQA' logo indicates that this device is playing an MQA sound source with the same quality as the source level sound. “MQA Studio” indicates that the device is playing an MQA Studio file approved by the artist/producer in the studio or verified by the copyright owner.
- MQA and Sound Wave devices are registered trademarks of MQA, Ltd. © 2016

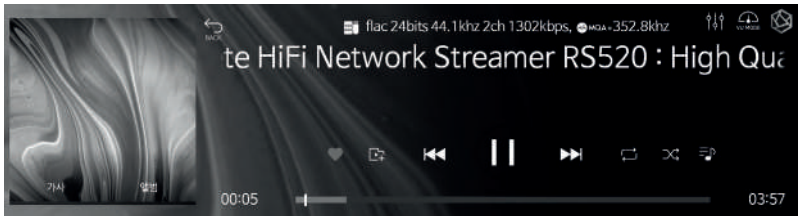

## 3. Factory Reset

---

- Factory reset is recommended when this product does not work or Internet firmware upgrade fails. Upon factory reset, all custom settings including DB scan data, settings and saved data from each application, applications installed through ROSE Store, Wi-Fi network settings, shared files, and saved playlists will be reset. It is necessary to reset these data after factory reset.
- This product can be factory reset or restored to the initial setting.
- You can revert to the initial settings in the Settings - System Settings - Factory Reset menu option.

# Product Specifications

## 1. Specifications

| Part               |                  | Specifications   |
|--------------------|------------------|--|
| OS                 |                  | Customized Android 7.1   |
| Design             | Size             | 346(W) x 328(D) x 127(H)mm   |
|                    | Weight           | 8.1kg  |
|                    | Display          | 12.6" TFT LCD & Capacitive Touch Screen (eDP)  |
| CPU                | Hexa Core CPU    | Dual-core Cortex-A72 up to 1.8GHz<br>Quad-core Cortex-A53 up to 1.4GHz   |
| GPU                |                  | Mali-T864 GPU, OpenGL ES1.1/2.0/3.0/3.1,<br>OpenVG1.1, OpenCL, DX11  |
| Memory             |                  | LPDDR4 4GByte  |
| DAC Chip           |                  | ES9038PRO(ESS) 8-Channel Audio DAC   |
| Network Connection | Ethernet         | 10/100/1000 BASE-T   |
|                    | WiFi             | 802.11ac Dualband USB Wireless LAN Card (Dongle)   |
|                    | Bluetooth        | V4.2 (USB Dongle)  |
| Audio Service      | Streaming        | Airplay / DLNA / Roon Ready / Spotify Connect / Bluetooth  |
|                    | Music Service    | TIDAL / Qobuz / Bugs / ROSE Tube / Internet Radio / ROSE Podcast / Apple Music   |
| In/Output          | Audio Input      | Optical x 1, Coaxial x 1, Analog-In x 1, USB DAC x 1,eARCx1  |
|                    | Audio Output     | Optical x 1, Coaxial x 1, Analog-Out x 1   |
|                    | Video Output     | HDMI 2.0 x 1(up to 3840 x 2160 / 60Hz)   |
|                    | Media Connection | File System : NTFS / exfat / FAT32<br>Network Protocol : SMBv1, SMBv2 / FTP / WebDav<br>Storage Interface : USB3.0 x 2, SATA x 1   |
| Supported Codec    | Audio            | MQA, WAV, FLAC, AIFF, WMA, MP3, OGG, APE, DFF, DSF, AAC, CDA, AMR, APE, EC3, E-EC3, MID, MPL, MP2, MPC, MPGA, M4A, ALAC<br>PCM : 8kHz~768kHz(8/16/24/32bit per Sample)<br>Native DSD : DSD64(2.8MHz)/DSD128(5.6MHz)/<br>DSD256(11.2MHz)/ DSD512(22.4MHz) |
|                    | Video            | ASF, AVI, MKV, MP4, WMV, MPEG-1, MPEG-2, MPEG-4 H.263, H.264, H.265, VC-1, VP9, VP8, MVC, H.264/AVC, Base/Main/High/High10 profile @ level5.1 up to 4Kx2K @ 30fps<br>H.265/HEVC, Main/Main10 profile @ level 5.1 High-tier up to 4Kx2K @ 60fps           |

|                               |                          |  |
|-------------------------------|--------------------------|--|
| <b>Power</b>                  | <b>Input Voltage</b>     | AC100-240V 50/60Hz   |
|                               | <b>Power Consumption</b> | 150W   |
|                               | <b>Circuit Breaker</b>   | 6A Thermal Circuit Breaker   |
| <b>Update</b>                 |                          | SW update via internet, USB OTA, ROSE Store  |
| <b>Remote Control Feature</b> | <b>Remote Controller</b> | 38kHz Infrared Ray(Within 10m of Operating Distance), Bluetooth Remote Control               |
|                               | <b>Remote App</b>        | ROSE Connect (Android, iOS) / Google PlayStore, App Store                                    |
| <b>Accessory</b>              |                          | Power Cord x 1, Bluetooth Remote Controller x 1 (AAA Battery x 2), Manual x 1, SSD Screw x 4 |

## 2. Analog Audio Specifications

|                              |                |  |
|------------------------------|----------------|--|
| <b>Output Power</b>          | -              | 250W + 250W @ 8Ω, 4Ω                           |
| <b>Sensitivity</b>           | <b>Line in</b> | 2Vrms  |
|                              | <b>Pre Out</b> | 2Vrms  |
| <b>Power Bandwith</b>        | <b>-3dB</b>    | 10Hz ~85kHz, 8Ω, 200W                          |
| <b>THD+N</b>                 | <b>Pre Out</b> | 0.00033%, 1kHz, 600Ω, 2Vrms                    |
|                              | <b>Speaker</b> | 0.007% @ 50W, 0.01% @ 100W, 0.1% @ 250W, x2/8Ω |
| <b>Damping Factor</b>        | <b>1kHz</b>    | 150  |
| <b>Input Impedance</b>       | -              | 100kΩ  |
| <b>Output Impedance</b>      | -              | 50mΩ   |
| <b>Frequency Response</b>    | <b>+1/-3dB</b> | 10Hz ~ 83kHz                                   |
| <b>Signal-to-Noise Ratio</b> | <b>Pre Out</b> | 124dB, 1kHz, 600Ω, 2Vrms                       |
|                              | <b>Speaker</b> | 109dB, 1kHz, 8Ω, 250W                          |

# Warranty

|                          |  |
|--------------------------|--|
| <b>Model Name</b>        | RS520                                  |
| <b>Purchase Date</b>     | 20      Year      Month      Date      |
| <b>Place of Purchase</b> | Shop Name                              |
|                          | Contact Address                        |
| <b>Serial No</b>         |  |
| <b>Contact Address</b>   |  |
| <b>Warranty Period</b>   | Until 1 year from the date of purchase |

- Name of the Company Received the Conformity Assessment: CI TECH Co., Ltd.
- Manufacturer/Country of Manufacture: CI TECH Co., Ltd. / Republic of Korea
- Identification Code of the Certified Company: SYH
- Certification No.: R-R-SYH-520

### **Q. The product does not turn on.**

- After disconnecting the power cord from the outlet, wait for about 10 seconds, then plug it back in and turn on the power.

### **Q. Which one should I use, Ethernet or Wi-Fi?**

- In an environment where Ethernet connection is possible, using Ethernet will help you enjoy more stable music.

### **Q. Can I watch the video played on the ROSE device on the TV and listen to the music through a separate speaker?**

1. Refer to 3-7 (page 29) and connect the HDMI port of the ROSE device to the TV.
2. Change the external input of the TV to match the HDMI port of the ROSE device.
3. Connect with the equipment you want to connect (DAC, amplifier, speaker, etc.).
4. Enable the audio output you want to connect in the Input/Output Settings of your ROSE device.  
※ The video signal is transmitted via the HDMI cable even if the output is not set to the HDMI port.
5. Play the music and video you want on your ROSE device.
6. When playing music, music information is automatically displayed on your TV.
7. When playing the video, change the TV button on the upper right of the RS520 screen to "ON".

### **Q. I logged in from the ROSE device after registering as a member on the Hi-Fi ROSE website, but the message "Member not found" appears.**

- For Hi-Fi Rose products, the account used on the Internet homepage and the account used on the ROSE device (or ROSE application) are separate. Please use the device after registering as a member using the ROSE device (or ROSE application).

- How to sign up for membership on ROSE devices: ROSE device > Settings > User Account > Log in > Sign up

How to sign up for membership in RoseConnectPremium: RoseConnectPremium > Settings > My Page > Sign up

### **Q. The output is fixed to HDMI in the input/output setting of the RS520, so I can't change it to another output.**

- Turn off the device, unplug the power cord, wait about 10 seconds, and then connect it again.

- If the same problem still occurs after turning the power back on, you can try factory reset. (See page 59.)

- If the problem is not resolved even after factory reset, please contact the distributor in the country where the purchase was made.

### **Q. I am trying to access the NAS over the network from my ROSE device, but I am getting a "network error".**

- Set the minimum SMB to SMB 1 in the NAS settings.

### **Q. Can I use the ROSE device as Roon Core?**

- The ROSE device is a Roon Ready product but cannot be used as a Roon Core.

### **Q. I played music, but there is no sound from the device.**

- Please check the volume.

- Please check the cable you connected.

- Make sure that the input and output you want to use are enabled in Input/Output Settings of the device.

### **Q. Do ROSE devices provide an equalizer (EQ)?**

- RS520 and RS201 models provide an equalizer.

### **Q. I can't connect my ROSE device to the RoseConnectPremium application.**

- You need to verify that the ROSE device and the smartphone running ROSE application are on the same network. The IP address displayed on the ROSE device and the IP address displayed on the registration screen of the ROSE application must be the same except for the last digit.

E.g. ROSE device > Settings > System Information > IP address > 192.168.2.63

ROSE application > Register ROSE > RoseConnect IP > 192.168.2.89

## **Check Before Contacting the Service Center**

---

- If touch does not work while using the device, or the screen stops working, you must restart the device. Press and hold the power button for more than 5 seconds to force reboot.
- When the product is used for a long time in a confined space that does not meet the installation conditions (page 20), heat may be generated, which may make the product hot and affect the life and performance of the product.
- When Internet connection is unstable or weak, or when Internet usage is high, sound may be cut off while listening. Also, wireless Internet reception may be delayed or not received due to the nature of wireless communication. Move to another location and try to connect again.
- Content files are optimized according to product characteristics, design standards, and the needs of operators.
- Therefore, even the same content may differ in volume or sound tone from different manufacturers and models.
- Exchange and Return Due to Product Defects
  - For initial defects of the product that occurred without the cause attributable to the consumer within 15 days of receiving the product, if the defect is confirmed by collecting the product, it can be exchanged or returned with a new product.
- Make sure you have a box with a genuine serial number and all accessories. If the box and accessories are damaged or lost, you may not be able to apply for exchange or return.
- Exchange and Return Due to Customer's Change of Mind
  - If the product and accessories are not opened, they can be exchanged or returned within 7 days of receipt.
- For exchange or return requests due to change of mind, please contact the agency where you purchased the product.

**Contact Us: <https://eng.hifirose.com/QnA>**

---

- You can get the phone number and location information of the nearest service center from the Customer Service Center or website.

**Product Website: [www.hifirose.com](http://www.hifirose.com)**

---

- Get news about the latest events and new product information from ROSE through the newsletter

