

Integrated Amplifier **RA180**

- With Gallium Nitride Amplifier built in



rose





Integrated Amplifier - With Gallium Nitride Amplifier built in RA180

- Class AD Amplifier with next generation GaN FET
- Multi Output Component
- Designed to play up to the Super Twitter Realm
- Balanced Power Supply
- PHONO Amplifier with Variable EQ

Design 430*350*110 mm / 16.7 kg / High Purity Aluminum / Color: Silver



In/Out Port	Analog In	Line1, Line2, Line3(Bypass), Balanced, Phono(MM/MC)
	Analog Out	Sub Woofer
Speaker	Stereo(A/B)	4ch 200W(8Ω)
	Stereo(A), BTL(B)	Stereo(A): 4ch 200W(8Ω) / BTL(B) : 2ch 400W(8Ω)
	BTL(A/B)	BTL(A) : 2ch 400W(8Ω) / BTL(B) : 2ch 400W(8Ω)

High Performance Network Streamer RS150 Series

- Flagship Network Streamer
- Network Streamer + DAC
- High-tech DAC design for pure sound with low noise and low distortion
- High-Resolution Music Playback available(DSD512, PCM32bit/768kHz)
- A Femto Clock provides Ultra Precision
- The Special Linear Power Supply Configuration minimizes electrical noise

Connectivity Bluetooth, DLNA, Airplay, Spotify Connect, Roon Ready
Design 430*300*110 mm / 11 kg / 14.9° Wide viewing angle touch screen / Color: Black, Silver



Hi-Res	DSD	Native DSD 512	In/Out Port	HDMI Out	4K
	PCM	32bit / 768kHz		USB Audio In	USB B Type 2.0
In/Out Port	Digital In	Optical, Coaxial, AES/EBU, HDMI ARC, USB Audio	Network Connection	USB Audio Out	USB A Type 3.0
	Digital Out	Optical, Coaxial, AES/EBU, I2S-DVI, I2S-RJ45		Ethernet	10/100/1000 BASE-T
	Analog In	Line In		Wi-Fi	Optional_dongle
	Analog Out	Pre-out XLR, Pre-out RCA		Bluetooth	Optional_dongle

Complete HiFi Network Streamer RS250

- Reference Grade All-in-One Network Streamer
- Network Streamer + DAC
- High-Resolution Music Playback available(DSD512, PCM32bit/768kHz)
- A Femto Clock provides Ultra Precision
- The Special Linear Power Supply Configuration minimizes electrical noise

Connectivity Bluetooth, DLNA, Airplay, Spotify Connect, Roon Ready
Design 278*202*76 mm / 3.2 kg / 8.8" Wide viewing angle touch screen / Color: Silver

Hi-Res	DSD	Native DSD 512	In/Out Port	Headphone Out	3.5mm
	PCM	32bit / 768kHz		USB Audio In	USB B Type 2.0
In/Out Port	Digital In	Optical, Coaxial	Network Connection	USB Audio Out	USB A Type 3.0
	Digital Out	Optical, Coaxial		Ethernet	10/100/1000 BASE-T
	Analog In	Line In		Wi-Fi	802.11 a/b/g/n/ac (2.4GHz/5GHz)
	Analog Out	Pre-out, RCA		Bluetooth	V4.0 / V3.0+HS
	HDMI Out	4K			

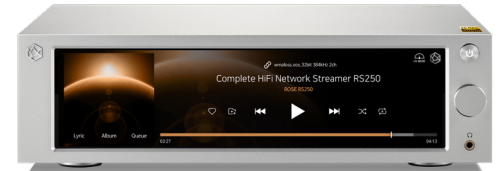

HiFi Network Streamer RS201 Series

- Reference Grade All-in-One Network Streamer
- Network Streamer + DAC + AMP
- Built-in High-Performance Power Amplifier(50W*2ch)
- High-Resolution Music Playback available(DSD256, PCM32bit/384kHz)
- A Femto Clock provides High Precision
- Digital equipment, PreAmplifier connection available
- Awarded the world's three major design awards(Reddot, GOOD DESIGN, PIN-UP)

Connectivity Bluetooth, DLNA, Airplay, Spotify Connect, Roon Ready
Design 278*202*76 mm / 2.3 kg / 8.8" Wide viewing angle touch screen / Color: Silver

Hi-Res	DSD	Native DSD 256	In/Out Port	Headphone Out	3.5mm
	PCM	32bit / 384kHz		USB Out	USB A Type 3.0 / 2.0
In/Out Port	Digital In	Optical	Network Connection	AMP	50W X 2CH(4Ω)
	Digital Out	Optical		Ethernet	10/100/1000 BASE-T
	Analog In	Line In		Wi-Fi	802.11 a/b/g/n/ac (2.4GHz/5GHz)
	Analog Out	Pre-out, RCA		Bluetooth	V4.0 / V3.0+HS
	HDMI Out	4K			



HiFi Media Player RS301

- High-end All-in-One Speaker
- Network Streamer + DAC + AMP + SPEAKER
- 3-Way full-range speaker configuration
- High-Resolution Music Playback available(DSD256, PCM32bit/384kHz)
- Powerful sound playback with dual passive woofer engine design(Patented technology)
- Awarded the world's three major design awards(Reddot, PIN-UP, iF)

Connectivity Ethernet, Wi-Fi, Bluetooth, DLNA, Airplay

Rear Micro USB, USB A Type, USB B Type, Micro SD, Headphone, AUX

Design 360*110*94 mm / 1.9 kg / 5" IPS touch panel / Color: Silver



Premium Media Player RS350

- Casual All-in-One Speaker
- Network Streamer + DAC + AMP + SPEAKER
- 3-Way full-range speaker configuration
- Playback of various file formats available(Music, Video, Image)
- Powerful sound playback with dual passive woofer engine design(Patented technology)

Connectivity Wi-Fi, Bluetooth, DLNA, Airplay

Rear Micro USB, USB A Type, Micro SD, Headphone

Design 364*110*98 mm / 1.5 kg / 5" IPS touch panel / Color: White



HiFi ROSE CD Drive RSA780 Series

- USB-isolator Adopted to block motion noise
- USB-B Type Port Adopted for HiFi Audio
- 900g weight for CD playback without external shaking
- Minimized Motion Noise by applying Insulators
- Provides CD Ripping Features

Rear USB B Type

Design 152*152*24 mm / 0.9 kg / Color: Silver



Innovative ROSE OS System



Hi-Res Audio

HiFi ROSE devices are certified with a 'High-Resolution Audio' license from the JAS (Japan Audio Society).



Spotify Connect

Spotify Connect allows you to play and wirelessly control Spotify music on your ROSE OS over a network. With the Spotify Connect function, you can enjoy a variety of music with HiFi sound quality on your ROSE device.



Roon Ready

ROSE OS is fully compatible with Roon Core, with Roon Ready certification in compliance with all requirements of Roon Labs. You can enjoy HiFi sound quality on your ROSE device with the powerful music management capabilities of Roon.



4K Video

You can enjoy high-definition videos on YouTube, TIDAL, and Bugs, and play video files in various formats.



TIDAL

Enjoy music streaming and videos with TIDAL's unique features. Supports MQA Full Decoder, so you can enjoy high-resolution music.



Qobuz

Enjoy music streaming with Qobuz's various functions. Support for Hi-Res Audio(24bit/192kHz) means you can enjoy high-resolution music.



MQA

Supports MQA's Full Decoder. Enjoy studio mastering sound quality.



Music

Manage your music files under various categories, such as albums, artists, and genres. Create your own playlist. You can also register your friends and share it with them.



Bugs

Listen to high-resolution music on Bugs. Easily connects existing functions, including login, playlists, and playback.



Radio

Listen to various Internet radio channels from around the world. Keep track of your favorite channels.



Clock

Various design clock functions are provided, such as alarms and weather information.



ROSE Tube

You can enjoy all content and music on YouTube.



ROSE Podcast

Listen to various podcasts from around the world.



CD Player

Play CDs by connecting an external USB CD-ROM.



CD Ripping

Rip CDs by connecting an external USB CD-ROM and save them on a storage device.

ROSE Connect Remote Application

A dedicated Remote App is provided that allows users to conveniently control and smartly manage their ROSE device. The Remote App is supported on various platforms, including the iPhone, iPad, Android phone, and PCs.

Control

You can freely and conveniently control various HiFi ROSE functions wirelessly.

Control You can control a variety of functions remotely including Music, ROSE Tube, TIDAL, Qobuz, Bugs, Radio, Podcasts, and CD Ripping.

Remote ROSE Connect includes the remote control function.

Search You can conveniently search for a variety of music in the Media Library.

Streaming

You can simply and easily play music stored on your phone on your ROSE device. Enjoy a lossless, high-quality streaming service.

Playlist

You can create your own playlist. Make a playlist on Music and ROSE Tube and check it out at Home - My Music.

Share with Friends

You can share your playlists with your friends or listen to music recommended by them. Communicate with your friends through music.

Media Library

Scan the music in your local memory to organize it into various categories.

GET IT ON
Google Play



Download on the
App Store

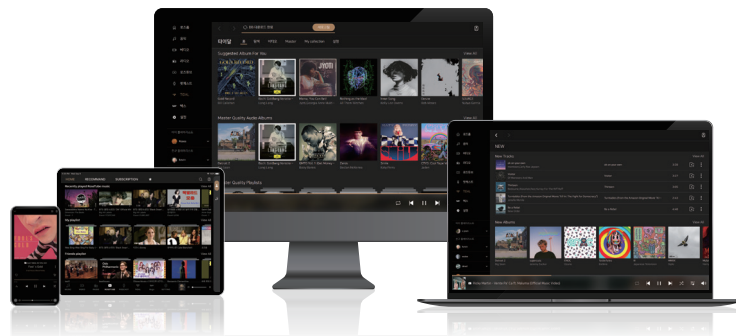

OWNER'S MANUAL

RA180 Product Owner's Manual

Table of Contents

Safety Precautions	12
1. Warnings	12
2. Precautions	12
Components List	14
Location / Function of Buttons and Ports	15
1. Front Side of the Product	15
2. Rear Side of the Product	18
3. Remote Control	20
Product Installation	22
1. Product Design Method and Recommended Installation Location	22
2. How to Connect the Power Cord	23
3. How to Properly Connect the Rear Ports and Cables	24
3-1. Connecting the Analog Input Port to the Power Amplifier	24
3-2. Connecting the Phono MM Compatible Input Port to an Audio Device	26
3-3. Connecting the Phono MC Compatible Input Port to an Audio Device	28
3-4. Subwoofer Output	30
3-5. Speaker A/B Output	31
3-6. Connecting the Speaker A/B Output When the BTL Mode Switch is Off	32
3-7. Connecting the Speaker A/B Output When the BTL Mode Switch is Set to Bi-Amp A / BTL B	34
3-8. Connecting the Speaker A/B Output When BTL Mode Switch is Set to BTL A / BTL B	36
3-9. How to Connect Connectors and Cables	38

4. Mobile Wi-Fi Settings	39
4-1. Main Home Screen	39
4-2. How to Register a Device	40
4-3. Device Search	42
5. Bypass · Power Amplifier Mode	46
5-1. How to Use Bypass · Power Amplifier Mode	47
Product Specifications	48
1. Specifications	48
Appendix	50
1. Bass Control Function of the Preamplifier	50
2. Treble Control Function of the Preamplifier	52
3. HPF Control Function of the H/F Crossover	54
4. Gain Control Function of the H/F Crossover	56
5. Subsonic ON/OFF Function	58
6. Phono Equalizer Curve	59
Warranty	60

Safety Precautions

1. Warnings

- Do not apply excessive force to the product, throw it, or strike it with sharp objects.
- When children use the product, parents must instruct them on how to use it correctly and make sure they do so.
- Use within a temperature range of 0 °C - 40 °C and do not use in hot or humid conditions. Install the product in a well-ventilated area, not an enclosed space, as product failure, corrosion, heat, or ignition may occur in an environment below 0 °C or in a sealed environment with a high temperature, such as a dry sauna. Moisture or liquid can also damage the surface of the product and its circuit components.
- Be sure to use a genuine power cable provided by ROSE. Any other cable may cause operational errors or damage (degradation of performance) to the product.
- To reduce the risk of fire or electric shock, do not expose the product to rain or moisture.
- Do not spill dirt or liquid on the product. It may damage the components and circuits. If the product gets wet, do not turn it on. Contact your nearest service center. However, free repairs are not available in this case.
- Protect the power cord from being stepped on or pinched. In particular, avoid pressing on the protruding parts of the product, such as plugs and outlets.
- Do not connect accessories not guaranteed by ROSE to the product, and do not place the product on any object that may interfere with radio waves (metal desk, microwave, etc.).
- Because the product is sensitive to radio waves, using it near steel or electromagnetic devices can lead to poor performance.

2. Precautions

- The contents of the owner's manual are described based on the default settings of the product.
- Some contents of this manual may be changed without prior notice to the user in order to improve product performance.
- The features and additional services of the product may vary depending on the country, software specifications, and policy changes of the service provider.
- Because the product is sensitive to radio waves, using it near steel or electromagnetic devices may lead to poor performance.
- Do not use chemical solutions (alcohol, thinners, solvents, etc.) or detergent to clean the product. Rubbing the product with a chemical solution can create heat and cause the product to catch fire. When cleaning the product, wipe it with a soft cloth or dry towel.
- Do not disassemble, modify or repair the product on your own. If you do, you will no longer qualify for free repairs. If a malfunction occurs because of this, contact an authorized service center for repairs.
- Install the product close to an outlet so that it is easy to remove the plug from the outlet.

- To completely disconnect the product from the AC main power source, unplug the power supply cord from the AC outlet.
- Do not use the product near water. Do not expose the product to a dripping or splashing environment and do not place objects containing liquids, such as vases, on the device.
- Do not block the ventilation openings. Install this product according to the product installation and orientation instructions.
- Unplug the product during lightning storms or when unused for long periods of time.
- **Precautions for Child Protection**
 - If one of the coin batteries inside the remote control is swallowed, it may cause serious burns or death within two hours.
 - Store new and used batteries out of the reach of children.

⚠ Caution

• Precautions for High-Temperature Parts During Set Operation

- These parts are for discharging the high temperature inside the set to the outside, and they may cause burns during the set operation. Be sure to turn off the power and wait for 30 minutes.

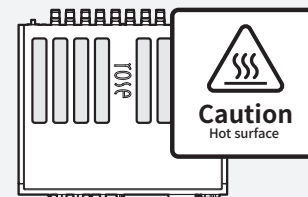



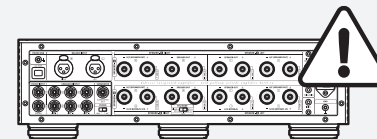

⚠ Caution

• Precautions for Electric Shock Caused by the Set

- When the volume is high, the speaker output is high, and high voltage and high current power flows. Be sure to turn off the power when touching or connecting.
- Do not touch with wet hands while the power is on.

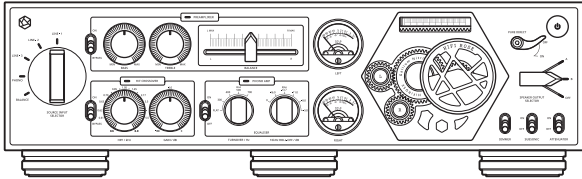

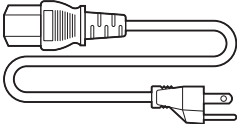
Components List

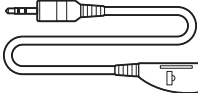
1	Main Device	 A detailed line drawing of the main device, a rectangular control unit with various knobs, buttons, and a large circular display on the right side. It has four feet at the bottom.
2	Remote Control (including battery)	 A line drawing of a remote control with a battery cover on the back. The battery cover is open, revealing five AA batteries. The number '101R' is printed on the back of the remote.
3	Power Cable	 A line drawing of a power cable with a three-pronged AC plug on one end and a specialized connector on the other.
4	User Manual	 A simple line drawing of a rectangular book cover with the word "MANUAL" printed in the center.
5	External IR Receiver	 A line drawing of an external IR receiver cable with a three-pronged AC plug on one end and a specialized connector on the other.

Location / Function of Buttons and Ports

1. Front Side of the Product

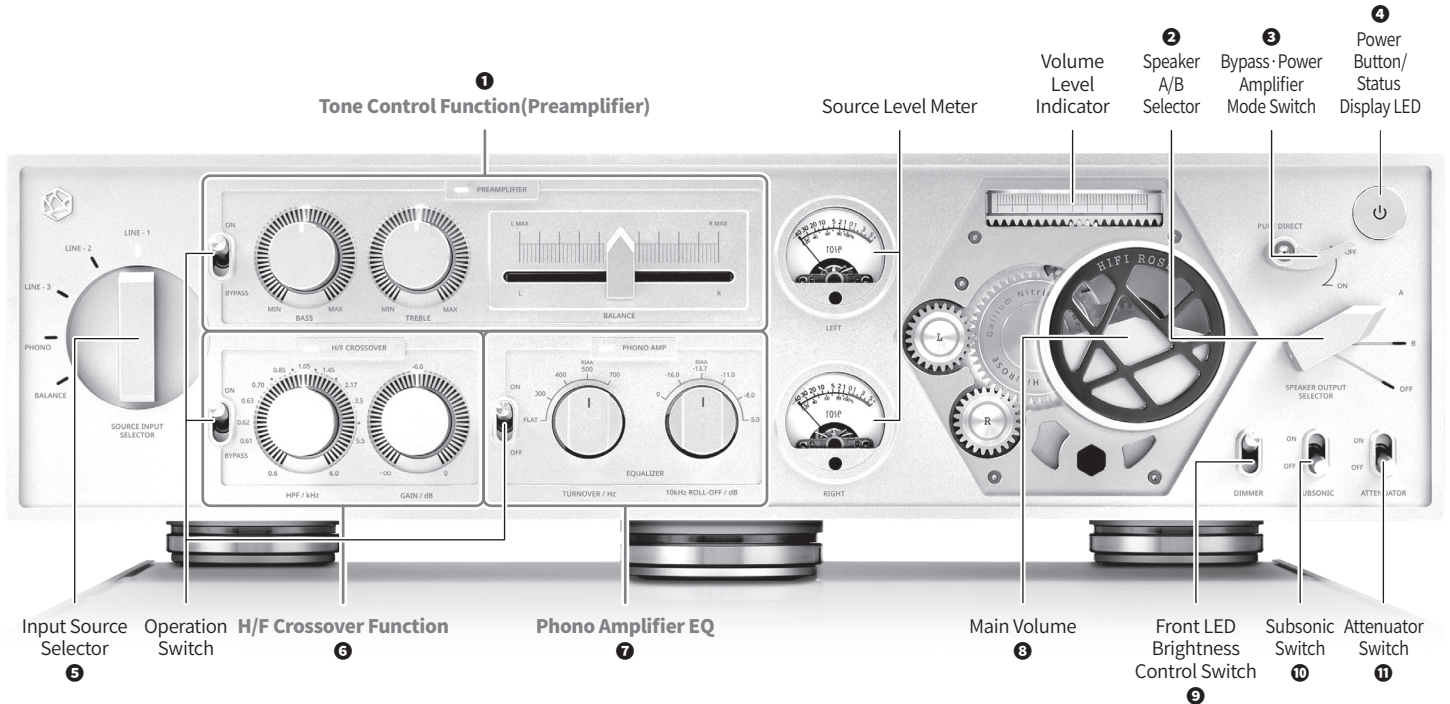

1	Tone Control	<ul style="list-style-type: none"> • TREBLE: Controls the frequency characteristics of the high frequency range. When the knob is set to the center position, a flat frequency characteristic is obtained. Turning it clockwise enhances the high-frequency range, and turning it counterclockwise attenuates the high-frequency range. • BASS: Controls the frequency characteristics of the low frequency range. When the knob is set to the center position, a flat frequency characteristic is obtained. Turning it clockwise enhances the low frequency range, and turning it counterclockwise attenuates the low frequency range. • BALANCE: Adjusts the volume balance between the left and right channels. Moving this switch to the left in frontal reference increases the left sound volume and moving it to the right increases the right sound volume. This switch should be set to the center position under normal conditions. <p>※ <i>The bass and treble knobs and the balance switch do not work when the bypass · power amplifier mode switch is turned on.</i></p> <p>※ <i>When the preamplifier is set to BYPASS, the bass and treble knobs other than the balance switch do not work.</i></p> <p>※ <i>Please refer to pages 50 - 53 for details.</i></p>
2	Speaker A/B Selector	Two sets of speakers can be connected, and the speaker can be selected by adjusting the switch.
3	Bypass-Power Amplifier Mode Switch	<p>When activated, the input signal bypasses the preamplifier stages such as balance, tone control, active crossover, and volume, and operates in power amplifier mode.</p> <p>※ <i>However, if the input signal is high, it may damage the speaker. Be sure to reduce the input signal before use.</i></p> <p>※ <i>To use this function, the source device must be connected to LINE 3.</i></p> <p>※ <i>Please refer to page 46 for details.</i></p>
4	Power Button / Status Display LED	<p>When the power button is pressed, the LED blinks, and when booting is complete, the LED turns off.</p> <p>※ <i>If there is no input signal for more than 1 hour, the power of this product is automatically turned off. If it is turned off automatically, turn it on again with the power button on the main body or the power button on the remote control to use it. (You can set the time in the automatic power off (APO) function of the mobile app.)</i></p>
5	Input Source Selector	Selects the input of devices such as DACs, CD players, and tuners connected to each input on the rear side. The input selector is compatible with a total of five external inputs: three line inputs, one balanced input, and one phono input. It is also driven by an electric motor, so it can be controlled remotely.
6	H/F Crossover (High Frequency)	<p>Enables clear treble sound reproduction by specializing and outputting only the high-frequency range and removing the low frequency range</p> <ul style="list-style-type: none"> • HPF: Cuts the frequency characteristics in the range of 600 Hz - 6 kHz and outputs the high-frequency range of the reference frequency excluding the low-frequency range of the reference frequency. Applies characteristics only to H/F speaker output when BTL mode is not used. It limits the amplifier's amplification range, which is good for clear treble sound reproduction. • GAIN: Adjusts the gain of the area set by HPF. You can adjust the treble to suit your listening environment. The active crossover function does not work when the Bypass · Power Amplifier Mode Switch switch is turned on or H/F crossover is set to BYPASS. <p>If the H/F crossover is BYPASS, the output ranges are set to 20 Hz - 50 kHz, 80 kHz@-3 dB, and 100 kHz@-6 dB, allowing the speaker to run in biamping mode.</p> <p>※ <i>Please refer to pages 54 - 57 for details.</i></p>

7	Phono Amplifier EQ	<p>This unit is equipped with a phono amplifier compatible with MM/MC cartridges, enabling high-level analog record playback by connecting only a turntable.</p> <table border="1" data-bbox="699 152 1198 600"> <thead> <tr> <th colspan="3" data-bbox="699 152 1198 221">EQ Setting Characteristics Table (of Some Representative Manufacturers)</th> </tr> <tr> <th data-bbox="699 221 858 258">Manufacture</th> <th data-bbox="858 221 970 258">Turnover</th> <th data-bbox="970 221 1198 258">Roll-off. (10kHz / dB)</th> </tr> </thead> <tbody> <tr> <td data-bbox="699 258 858 295">RIAA</td> <td data-bbox="858 258 970 295">500Hz</td> <td data-bbox="970 258 1198 295">-13.7</td> </tr> <tr> <td data-bbox="699 295 858 332">Decca LP</td> <td data-bbox="858 295 970 332">500Hz</td> <td data-bbox="970 295 1198 332">-13.7</td> </tr> <tr> <td data-bbox="699 332 858 369">TELDEC/AES</td> <td data-bbox="858 332 970 369">500Hz</td> <td data-bbox="970 332 1198 369">-11</td> </tr> <tr> <td data-bbox="699 369 858 406">NAB</td> <td data-bbox="858 369 970 406">500Hz</td> <td data-bbox="970 369 1198 406">-16</td> </tr> <tr> <td data-bbox="699 406 858 443">Columbia LP</td> <td data-bbox="858 406 970 443">500Hz</td> <td data-bbox="970 406 1198 443">-16</td> </tr> <tr> <td data-bbox="699 443 858 480">CCIR</td> <td data-bbox="858 443 970 480">300Hz</td> <td data-bbox="970 443 1198 480">-11</td> </tr> <tr> <td data-bbox="699 480 858 517">European 78s</td> <td data-bbox="858 480 970 517">300Hz</td> <td data-bbox="970 480 1198 517">FLAT</td> </tr> <tr> <td data-bbox="699 517 858 554">American 78s</td> <td data-bbox="858 517 970 554">300Hz</td> <td data-bbox="970 517 1198 554">-5</td> </tr> <tr> <td data-bbox="699 554 858 598">Columbia 78s</td> <td data-bbox="858 554 970 598">300Hz</td> <td data-bbox="970 554 1198 598">-16</td> </tr> </tbody> </table>	EQ Setting Characteristics Table (of Some Representative Manufacturers)			Manufacture	Turnover	Roll-off. (10kHz / dB)	RIAA	500Hz	-13.7	Decca LP	500Hz	-13.7	TELDEC/AES	500Hz	-11	NAB	500Hz	-16	Columbia LP	500Hz	-16	CCIR	300Hz	-11	European 78s	300Hz	FLAT	American 78s	300Hz	-5	Columbia 78s	300Hz	-16
EQ Setting Characteristics Table (of Some Representative Manufacturers)																																			
Manufacture	Turnover	Roll-off. (10kHz / dB)																																	
RIAA	500Hz	-13.7																																	
Decca LP	500Hz	-13.7																																	
TELDEC/AES	500Hz	-11																																	
NAB	500Hz	-16																																	
Columbia LP	500Hz	-16																																	
CCIR	300Hz	-11																																	
European 78s	300Hz	FLAT																																	
American 78s	300Hz	-5																																	
Columbia 78s	300Hz	-16																																	
8	Main Volume	The main volume is driven by an electric motor and can be adjusted remotely.																																	
9	Front LED Brightness Control Switch	Adjusts the brightness of the light on the front of the product in 3 steps.																																	
10	Subsonic Switch	<p>Cuts off ultra-low frequencies to prevent extra-low frequencies from negatively affecting the speaker when the switch is on. This function is especially effective when the record on the turntable around the speaker vibrates or the woofer shakes due to the ultra-low frequency vibration of the speaker.</p> <p>※ <i>When the bypass-power amplifier mode switch is set to ON, this switch does not work.</i> ※ <i>Please refer to page 58 for details.</i></p>																																	
11	Attenuator Switch	<p>Reduces the amount of output volume to a minimum level.</p> <p>This function is effective when you want to quickly turn down the volume when listening at a high volume, or when there is a risk of a shock sound from the speaker when changing the input selector.</p> <p>※ <i>When the bypass-power amplifier mode switch is set to ON, this switch does not work.</i></p>																																	

2. Rear Side of the Product

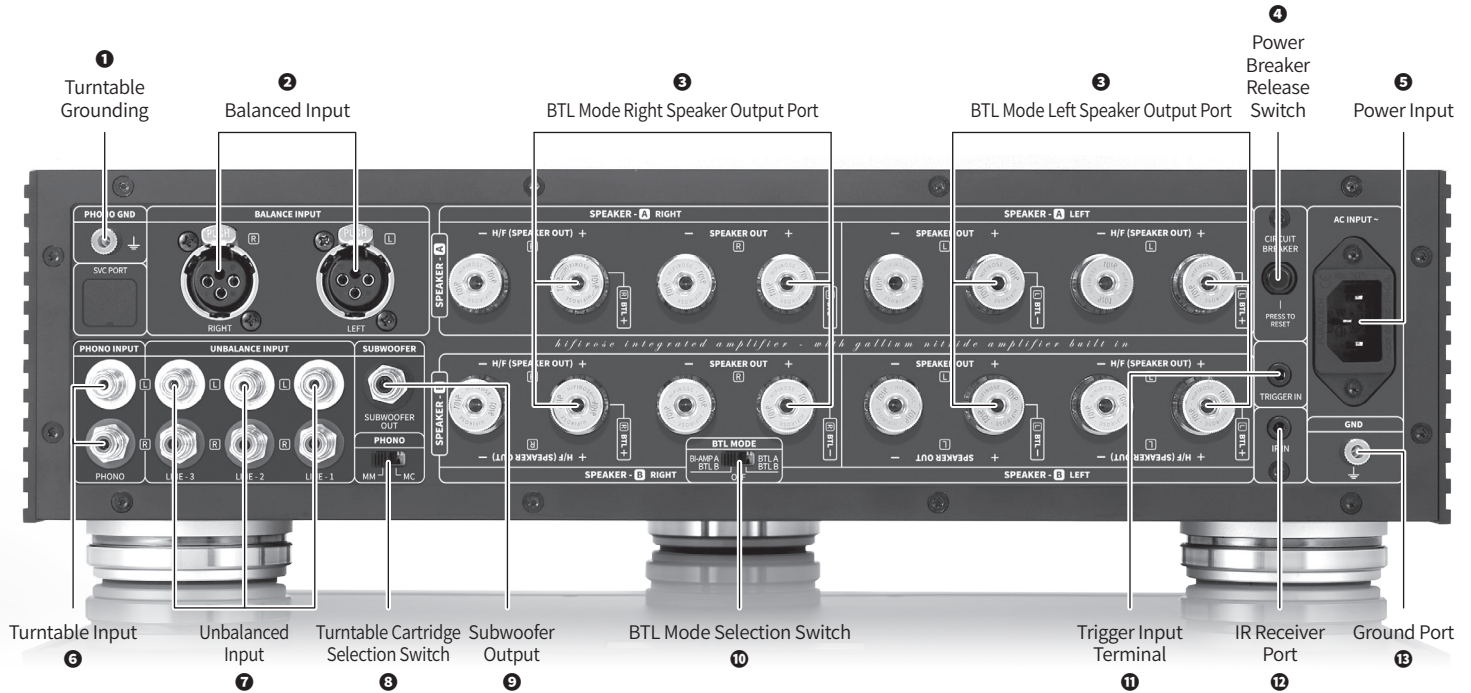

1	Turntable Grounding	When connecting the turntable, connect the ground line to reduce noise.
2	Balanced Input	This is a port that receives a balanced input (XLR) from an external source device, and the input sensitivity is 2 Vrms.
3	BTL Mode Speaker Output Port	By combining four mono amplifiers into two amplifier blocks, a 400 W (8 Ω) output per channel is possible.
4	Power Breaker Release Switch (Adopting a circuit breaker)	In order to improve the conductivity of the input electricity, a power circuit breaker was employed, and the sound quality resolution was improved by securing a wide passage for the input electricity.
5	Power Input Port	By adopting a Furutech terminal milled from pure copper optimized for audio, it transmits the input electricity without disturbing the purity.
6	Turntable Input	This is a port that receives RCA input from an external turntable device, and the input sensitivity is 5 mV in MM mode and 0.5 mV in MC mode. ※ <i>The phono (MM/MC) signal device is a device that receives a low audio signal and sends it out with a high output, so it is greatly affected by the signals of nearby external devices. Therefore, it is recommended that router devices such as Wi-Fi routers be kept at least 3 m away from this product.</i>
7	Unbalanced Input	This is a port that receives RCA input from an external source device, and the input sensitivity is 1 Vrms.
8	Turntable Cartridge Selection Switch	Changes the gain level of the equalizer amplifier. (Amplifier circuit required to reproduce analog records) • MM: Select an MM (moving magnet) cartridge with high output voltage. • MC: Select an MC (moving coil) cartridge with low output voltage. ※ <i>If you select MC while using an MM cartridge, you must be careful because the impedance increases the volume and produces an unbalanced sound without a high frequency.</i> ※ <i>The MC cartridge input signal is designed based on 0.5 mV. If you are using a turntable with a smaller output than this value, you may need to connect a separate step-up transformer. (A step-up transformer is not supplied with this product.)</i>
9	Subwoofer Output	This provides a rich low-pitched listening environment by connecting with an active subwoofer unit. ※ <i>Only active subwoofers (with separate built-in amplifiers) are compatible.</i>
10	BTL Mode Selection Switch	You can output three speakers with the BTL mode selection switch. • BI-AMP(A) / BTL(B) - A Speaker: Full Range L/R + Tweeter L/R output B Speaker: BTL L/R output • OFF: Full Range L/R + Tweeter L/R output for both A/B speakers • BTL: BTL L/R output for both A/B speakers
11	Trigger Input Terminal	This receives a 12 V trigger signal from a source device (DAC, CD player, turntable, preamplifier, etc.) and switches to the power-on state. ※ <i>See page 38 for details.</i>
12	IR Receiver Port	You can extend the operating range of the IR remote control by connecting the supplied IR receiver extension cord to this port.
13	Ground Port(⊥)	This is a port that connects the external device to the ground.

3. Remote Control

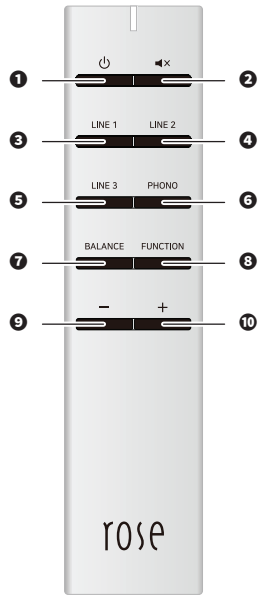

1	Power Button	Used to power the set on or off.
2	Mute Button	Used to mute music.
3	LINE 1	Move to the Line 1 input source position.
4	LINE 2	Move to the Line 2 input source position.
5	LINE 3	Move to the Line 3 input source position.
6	PHONO	Move to the phono input source position.
7	BALANCE	Move to the balanced input source position.
8	FUNCTION	-
9	-	Used to decrease the volume.
10	+	Used to increase the volume.

Product Installation

1. Product Design Method and Recommended Installation Location

- This product is designed to be used on a table or shelf.
- This product can malfunction during cold or hot weather. (Operating temperature: 0 - 40°C, Storage temperature: -10 - 50°C)
- If the product is installed in a small space, be sure to provide adequate ventilation. A longer operating life is ensured when electronics are properly ventilated and maintained so that they do not overheat more than necessary. Do not install this product directly on a device that generates a lot of heat.
- The figure below shows the minimum ventilation requirements required for the product.
- Keep a space of at least 2.5 cm on each side of this product to prevent airflow from clogging.
- Secure a depth of 45 cm for airflow and cabling.

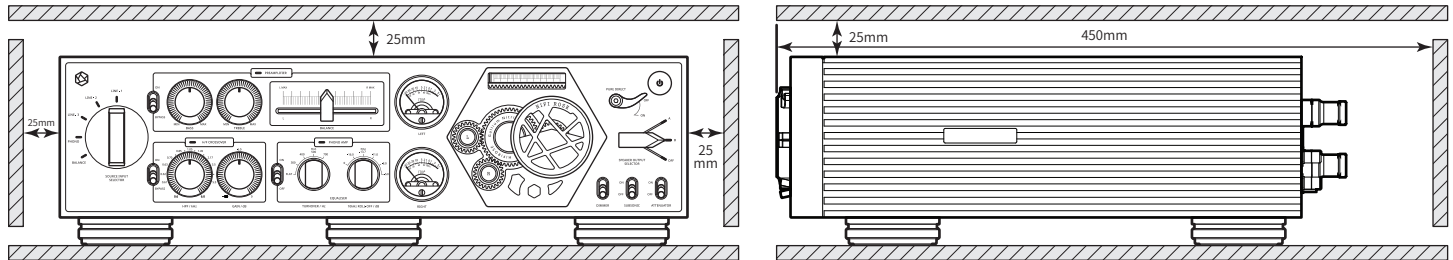

2. How to Connect the Power Cord

- This product includes a removable power cord. Please connect the power cord after connecting all the audio cables.

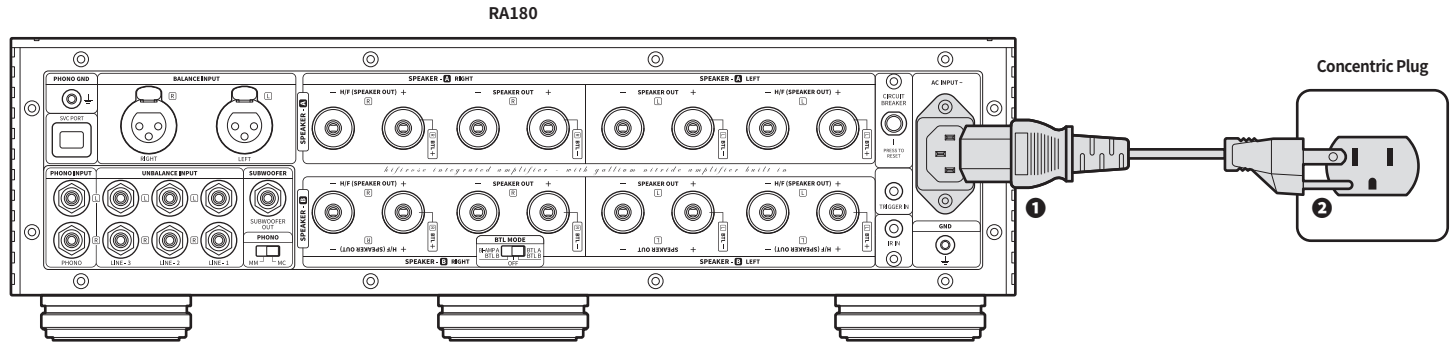

⚠ Caution: Always disconnect the power cord from the outlet side first.

3. How to Properly Connect the Rear Ports and Cables

3-1. Connecting the Analog Input Port to the Power Amplifier

- As shown in the figure below, you can connect the analog output port of the source device to the analog audio input (Balanced/Line 1 - 3) of this product.
- For the analog audio input sensitivity of Lines 1, 2, and 3 this product, export a maximum output of stereo 200 W (8 Ω) / BTL 400 W (8 Ω) at up to 1 Vrms (2.218 dBu).
- For the balance analog audio input sensitivity of this product, export a maximum output of stereo 200 W (8 Ω) / BTL 400 W (8 Ω) at up to 2 Vrms (8.23 dBu).
- After connecting the cables, connect the power cable. There may be a risk of electric shock.
⚠ Caution: *Before connecting this product to a power amplifier, set the volume of the product to mute or below level 5, and then connect it using an RCA cable. If you connect the cable while the product is playing music at a high volume, a loud shock sound may occur.*
- The XLR jack connection configuration polarity is shown below.

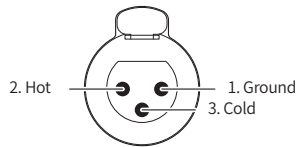

RA180

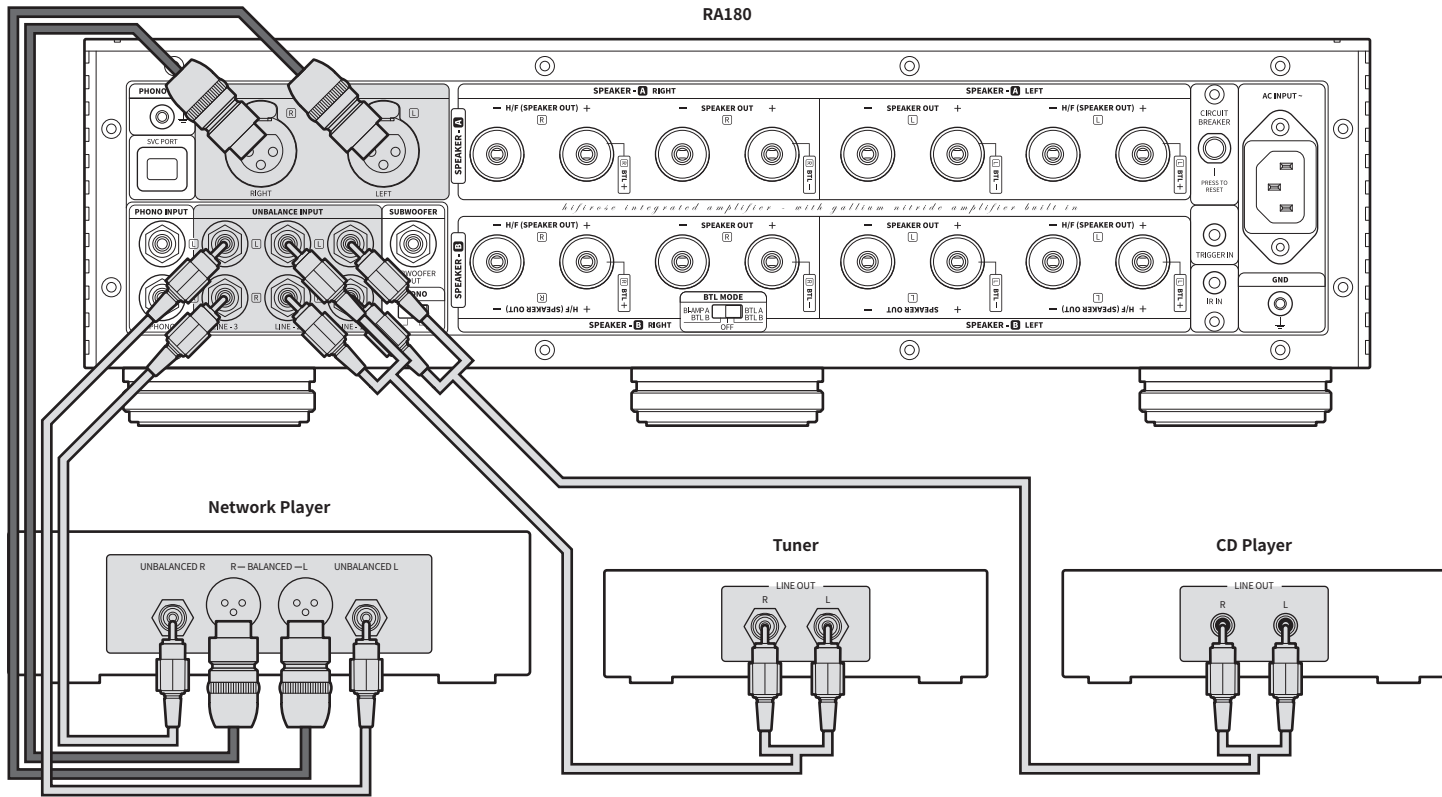

3-2. Connecting the Phono MM Compatible Input Port to an Audio Device

- You can connect the analog output of the turntable to the phono analog audio input (PHONO IN) of this unit, as shown in the following figure.
- When using the phono audio input as the source, you need to switch the input source to “PHONO” in the input settings. Input settings can be changed by remote control or manually.
- Although the default switch setting is MM mode (

- 26 -

RA180

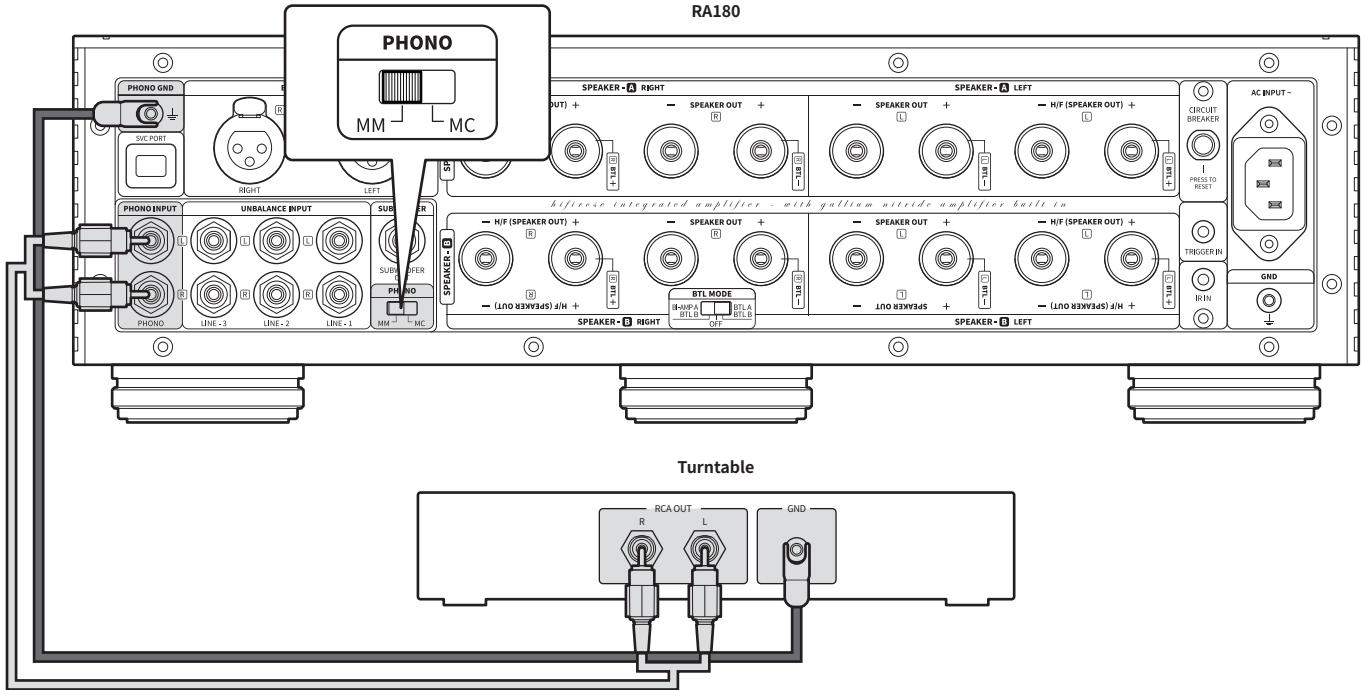

3-3. Connecting the Phono MC Compatible Input Port to an Audio Device

- You can connect the analog output of the turntable to the phono analog audio input (PHONO IN) of this unit, as shown in the following figure.
 - When using the phono audio input as the source, you need to switch the input source to “PHONO” in the input settings. Input settings can be changed by remote control or manually.
 - When using a phono product in MC mode, you need to change the rear phono mode switch () to MC.
 - In Phono MC mode, the input sensitivity is 0.5 mV (-63 dBu), and the maximum output is 200 W (8 Ω) for stereo / 400 W (8 Ω) for BTL.
 - If the input source of this product is set to “PHONO” and the volume is suddenly increased without a turntable connected, a humming noise may be heard from the speaker.
- ※ *The ground terminal (SIGNAL GND) of this product cannot be used for safety grounding. Connecting this terminal when there is a lot of noise may reduce the noise. Depending on your turntable, connecting the ground wire may have the opposite effect as it increases noise. In this case, there is no need to connect the ground wire.*

RA180

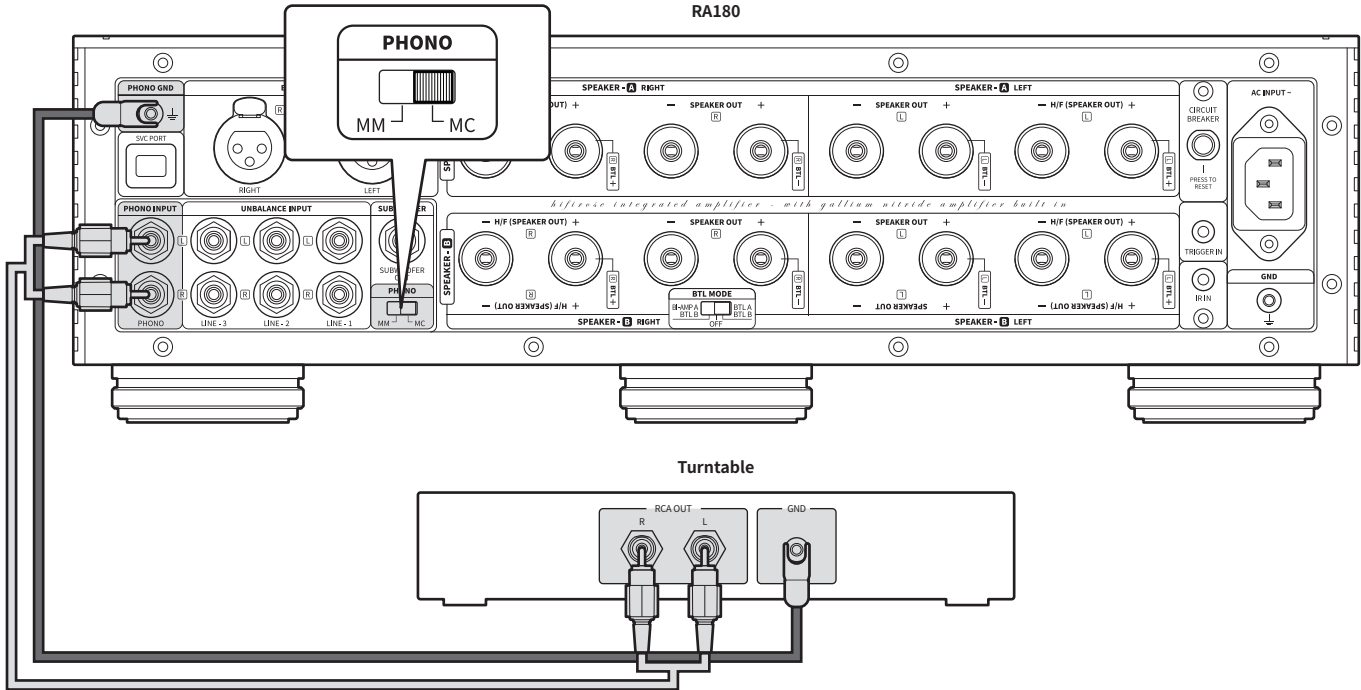

3-4. Subwoofer Output

- As shown in the figure below, you can connect an active woofer device to the subwoofer audio output of this product.
- The analog audio output of this product is up to 1 V (rms) / (2.218 dBu).

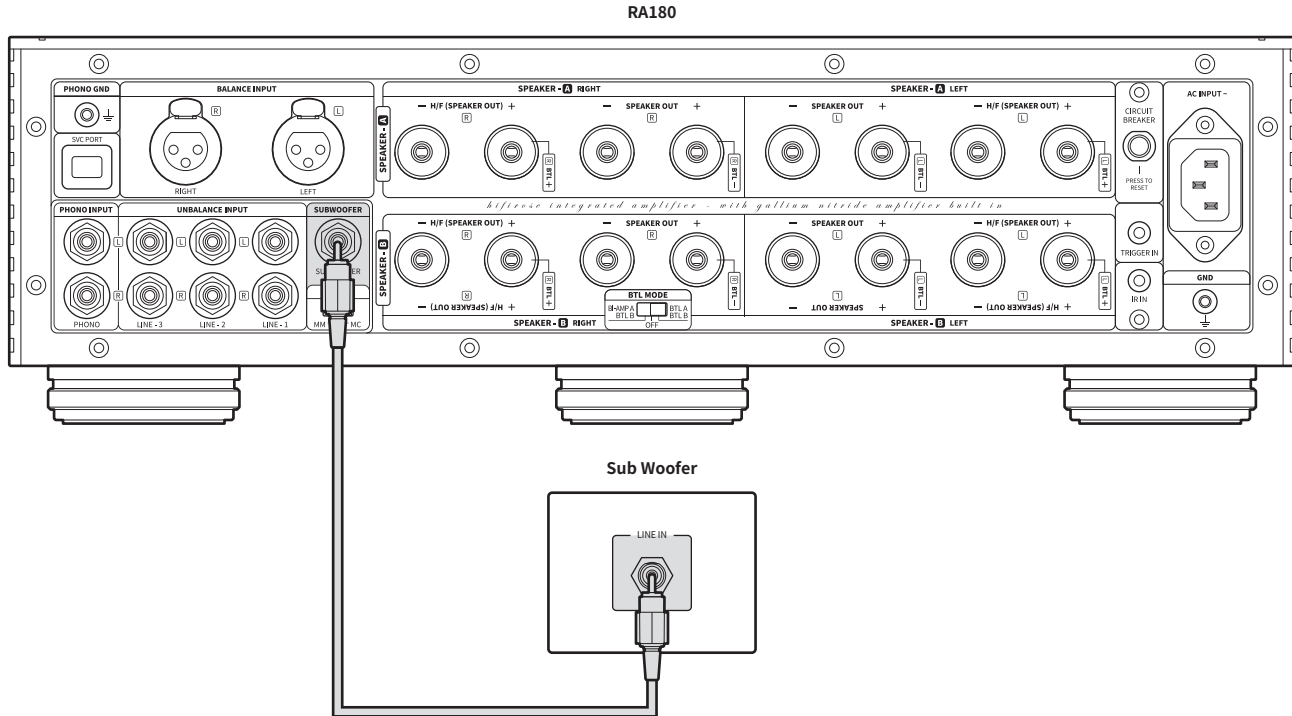

3-5. Speaker A/B Output

- As shown in the figure below, the speaker output of this product can be output to A or B, but simultaneous output is not possible.
- If you want to output to speaker A, set the speaker output selector switch on the front to A.
- If you want to output to speaker B, set the speaker output selector switch on the front to B.

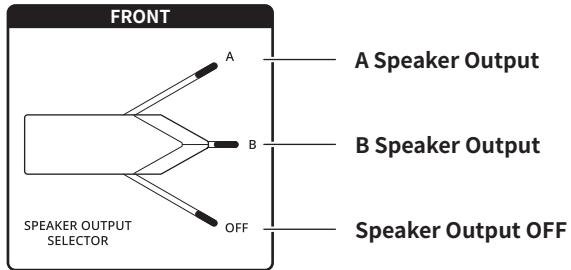

3-6. Connecting Speaker A/B Output When BTL Mode Switch Is Off

- When the switch is off, both A/B are composed of four channels in a stereo method, and each channel outputs a maximum of 200 W (8 Ω).
- When the switch is off, both A/B are composed of four channels in a stereo method, and each channel outputs a maximum of 200 W (8 Ω). (For speaker configuration, four full-range speakers (200 W or higher) and four super tweeter speakers (200 W or higher) are required. When you want to output to A or B speaker, you can change the speaker output selection switch on the front and listen to it with the desired speaker.)
- Speakers A and B are not output at the same time.

3-7. Connecting the Speaker A/B Output When the BTL Mode Switch Is Set to Bi-Amp A / BTL B

- When changing the BTL mode switch to BI-AMP A / BTL B mode, the speaker must be connected as shown in the figure below.
- A Mode consists of four channels in a stereo method, and outputs up to 200 W (8 Ω) for each channel.
(For speaker configuration, two full range speakers (200 W or higher) and two super tweeter speakers (200 W or higher) are required. If you set the speaker output selection switch on the front to A, you can output the speaker in Bi-Amp Mode.)
- B Mode consists of two channels in BTL method, and outputs up to 400 W (8 Ω) for each channel.
(For speaker configuration, two full range speakers (400 W or higher) are required. If you set the speaker output selection switch on the front to B, you can output the speaker in BTL Mode.)
- Speakers A and B are not output at the same time.

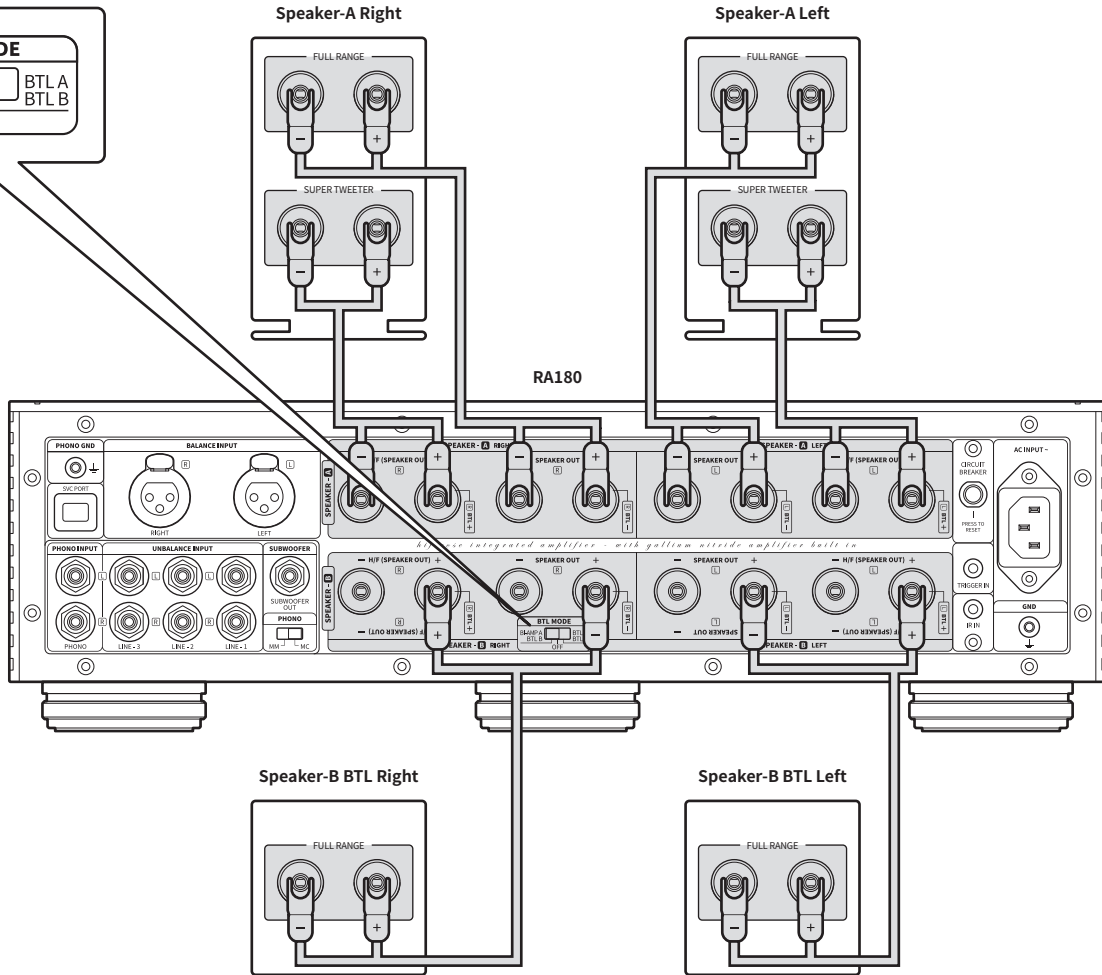
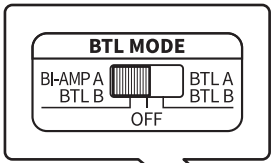

3-8. Connecting the Speaker A/B Output When BTL Mode Switch Is Set to BTL A / BTL B

- When changing the BTL mode switch to BTL A / BTL B mode, the speaker must be connected as shown in the figure below.
- BTL A/B Mode consists of two channels in BTL method, and outputs up to 400 W (8 Ω) for each channel.
(For speaker configuration, two full-range speakers (400 W or higher) are required. When you want to output to A or B speaker, you can change the speaker output selection switch on the front and listen with the desired speaker.)
- Speakers A and B are not output at the same time.

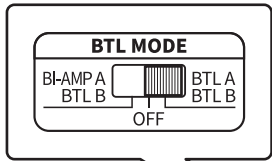

Speaker-A BTL Right

Speaker-A BTL Left

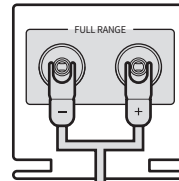
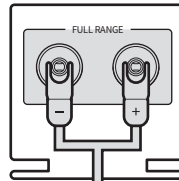

RA180

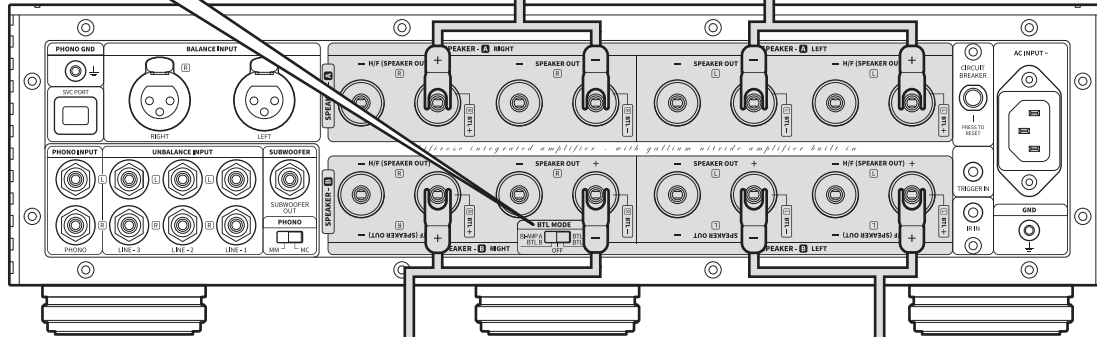

Speaker-B BTL Right

Speaker-B BTL Left

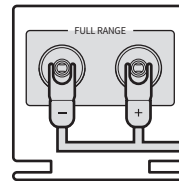
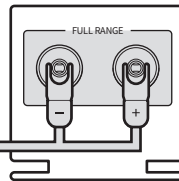

3-9. How to Connect Connectors and Cables

3-9-1. Trigger Input Terminal and Pinout

- The trigger function can control the power by linking the product and the source device.
- If you are using a source device with a trigger output terminal, you can use the trigger function by connecting it to the trigger input port of this product with a monaural mini terminal cable.

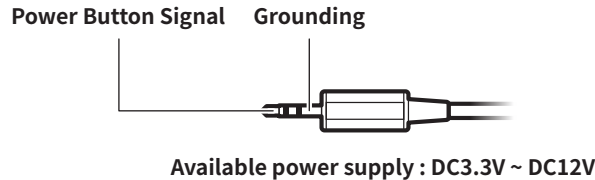

3-9-2. External IR Input Terminal and Pinout

- This is used when the product is installed on a table or shelf that is not visible from the outside, or when it is located in a place where communication with the internal IR is impossible.
- The IR external receiver uses a 3.5 mm stereo mini phone plug. Refer to the following figure for the pinout.

※ *When the external IR terminal is connected, the internal IR receiver of this device does not operate.*

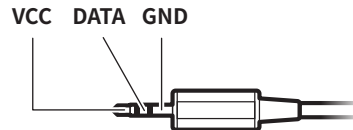

4. Mobile Wi-Fi Settings

4-1. Main Home Screen

- This is the screen that appears when you run AMP Connect for the first time. You can connect the amplifier to the network by selecting A. You can also select B to search for amplifiers with network connections.
 - The connection sequence is as follows.
 1. Search for the amplifier in the Wi-Fi settings of the mobile phone (tablet) and connect the amplifier.
 2. Connect the amplifier connected in the above step to the network (Wi-Fi).
 3. After connecting the amplifier to Wi-Fi, check that the mobile phone (tablet) and amplifier are connected to the same network (Wi-Fi).
- ⚠ **Caution:** *If the amplifier and the mobile phone (tablet) are not connected to the same network, the amplifier will not be searched.*

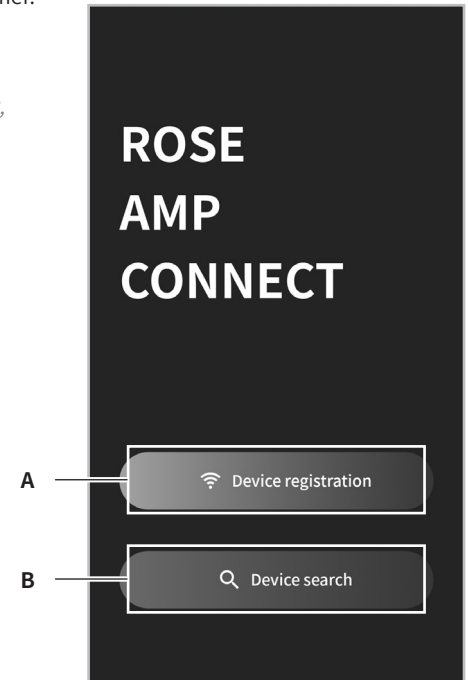

4-2. How to Register a Device

4-2-1.

This is the first screen to register the network of the amplifier. Please select “Next.”

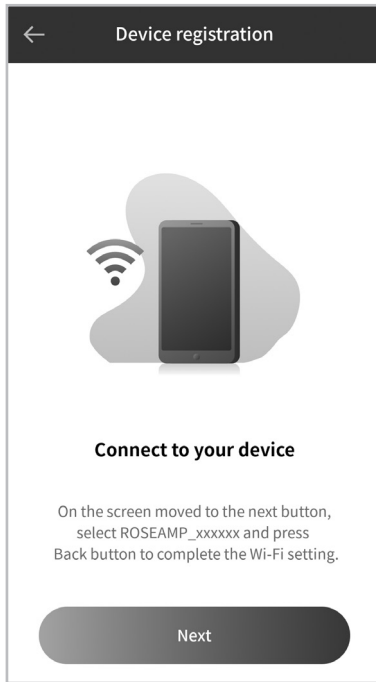

4-2-2.

If you press and release the power button of the amplifier to be connected for 5 seconds, the backlight blinks and it goes into the connection standby state, and the amplifier to be connected is displayed as ROSEAMP_XXXXXX on the Wi-Fi list. Select the amplifier that appears and select “Back” when the amplifier list is displayed as connected in the Wi-Fi list.

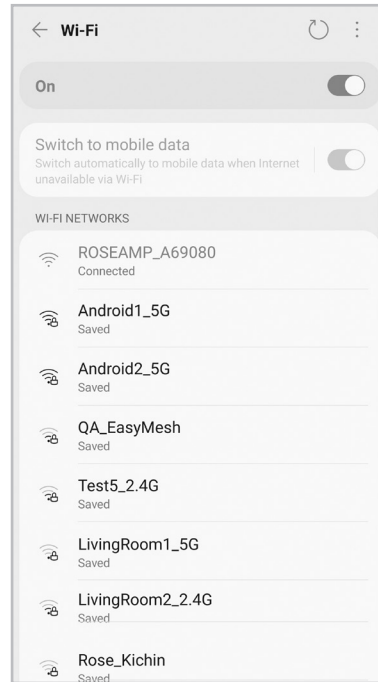

4-2-3.

Next is the screen to connect the network of the amplifier. Please connect the Wi-Fi to be used.

※ *The network of the amplifier does not support dual bands. Therefore, when connecting to a network with a frequency of 5 GHz, the network of the amplifier is not connected.*

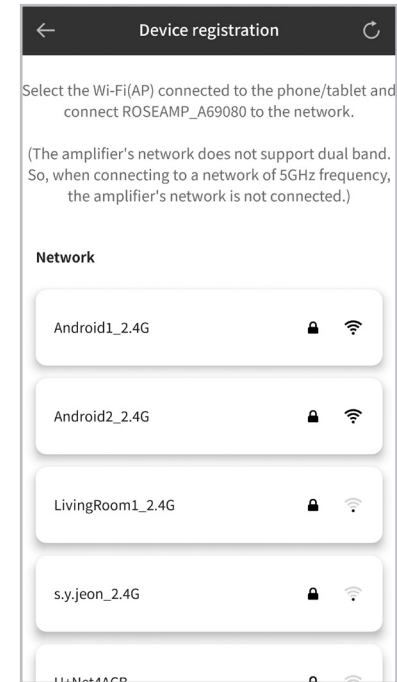

4-2-4.

This is the screen to check the network connection status of the amplifier.

- Check the Wi-Fi credentials of the amplifier.
- Check the Wi-Fi connection of the amplifier.
- Check the network status of the amplifier.

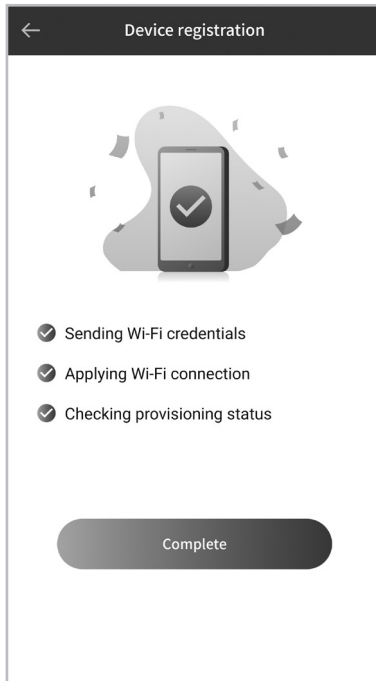

4-2-5.

Check that the device and the amplifier are on the same network.

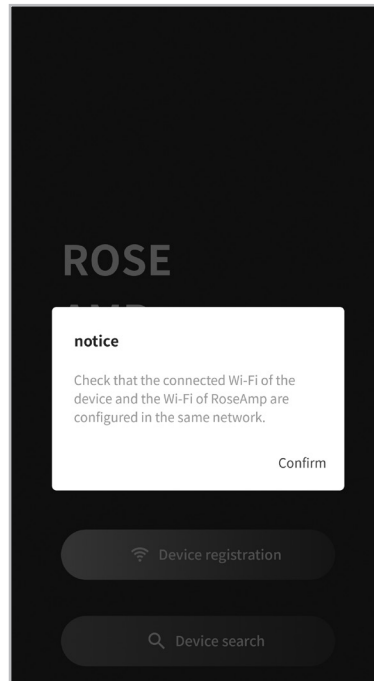

4-2-6.

This screen lists the amplifiers connected to the same Wi-Fi, and it is the screen that appears when you select B (Device Search) on the first screen.

For a detailed explanation, please refer to the following description. (4-3)

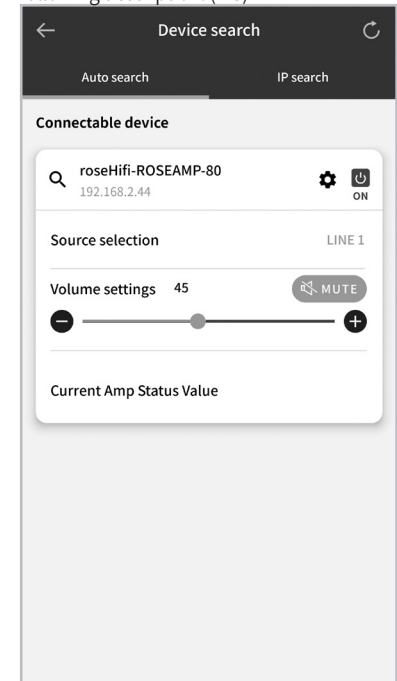

4-3. Device Search

4-3-1.

This is the screen for connecting by directly inputting the IP address of the amplifier connected to the Wi-Fi network.

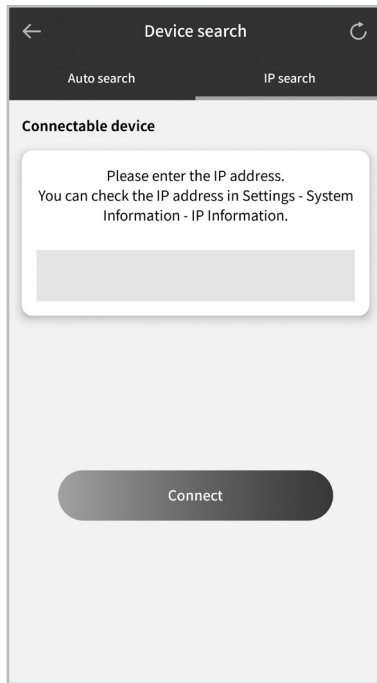

4-3-2. Device Connection Screen and Function Description

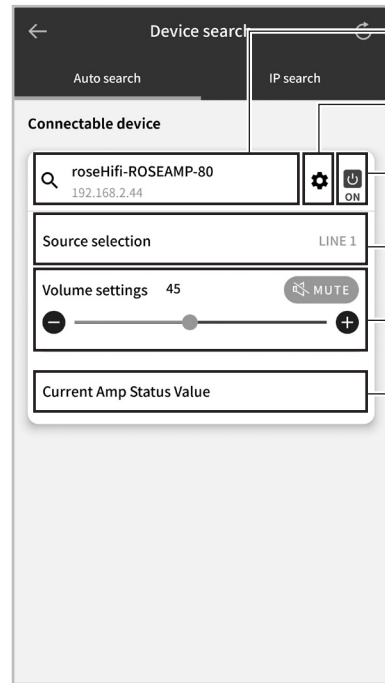

When you click the amp search function, the LED of the amplifier blinks for 10 seconds.

This shows the settings of the amplifier. (4-3-3. See further explanation.)

You can turn the amplifier power on/off.

You can select the output source of the amplifier. (4-3-8. See further explanation.)

You can adjust the amplifier volume.

This shows the detailed description value of the current amplifier. (4-3-9. See further explanation.)

4-3-3. Amplifier Settings

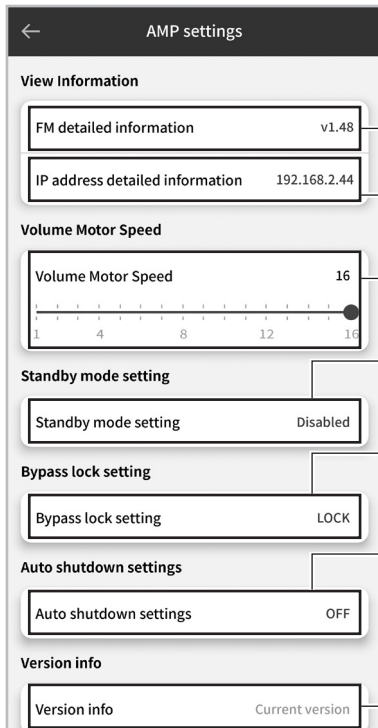

This shows the firmware version of the current amplifier. (4-3-4. See further explanation.)

This shows the IP address of the current amplifier. (4-3-5. See further explanation.)

This shows the current amp volume motor speed. You can adjust the speed.

This shows the current Wi-Fi mode. You can set the mode. (4-3-6. See further explanation.)

This shows the current bypass mode. You can set the mode. (5-1. See further explanation.)

You can set the time for the amplifier to automatically shut down after the set time has elapsed when there is no input signal to this product. (4-3-7. See further explanation.)

This shows the version information of the current amplifier. When there is an update, the update button is activated. If you select the activated update button, the update begins.

4-3-4. Detailed Firmware Version Information

If you select FW Details, the firmware details of the amplifier are displayed.

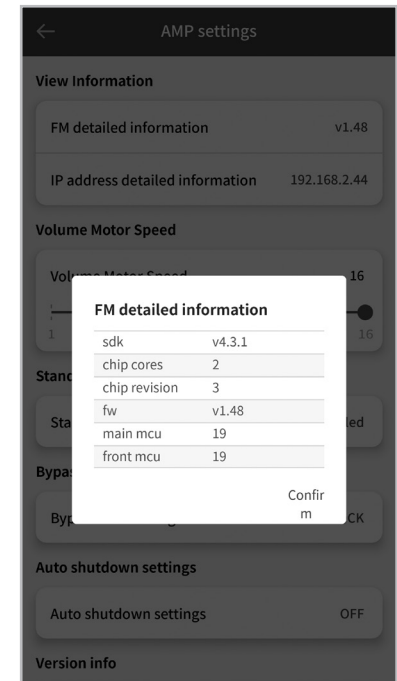

4-3-5. Detailed IP Information

If you select IP Details, the IP details of the amplifier are displayed.

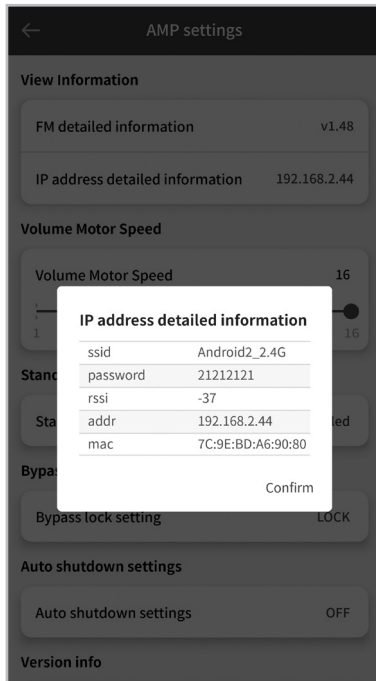

4-3-6. Wi-Fi ON/OFF Mode Setting

This shows the current Wi-Fi activation mode. You can set the mode.

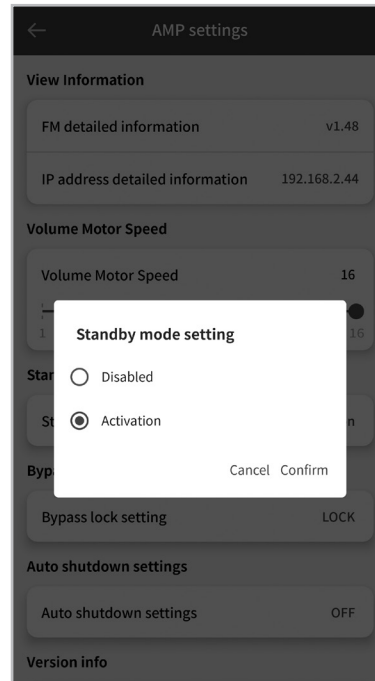

Deactivate

- This function deactivates the Wi-Fi function when the amplifier is powered off.
- After deactivation is set, power can only be turned on through a power switch or remote control. (Power cannot be turned on with the mobile app.)
- This is a mode to minimize power consumption. When Wi-Fi is deactivated, power consumption is less than 0.5W when the power is turned off.

Activate

- This function activates the Wi-Fi function when the amplifier is powered off.
- Power on/off is also possible on the mobile app after activation is set.
- Although this feature has the convenience of being able to turn the Wi-Fi function on and off freely even on a mobile device, power consumption when the feature is off is about 1.2 W, which is slightly more than when it is deactivated.

4-3-7. Auto Power Off (APO) Settings

You can set on/off and time for automatic power off (APO).

When turned off, the APO function is not used.

When turned on, the APO function is used, and if there is no input signal, the amplifier will automatically shut down after the set time.

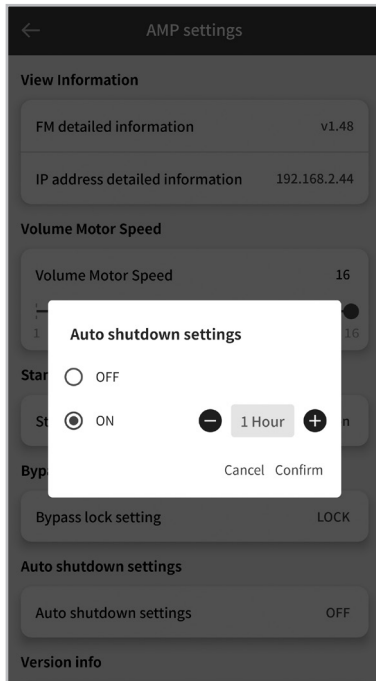

4-3-8. Input Source Selection Function Setting

You can change the output source of the amplifier, and you can change it to the desired output source by turning the wheel or selecting it.

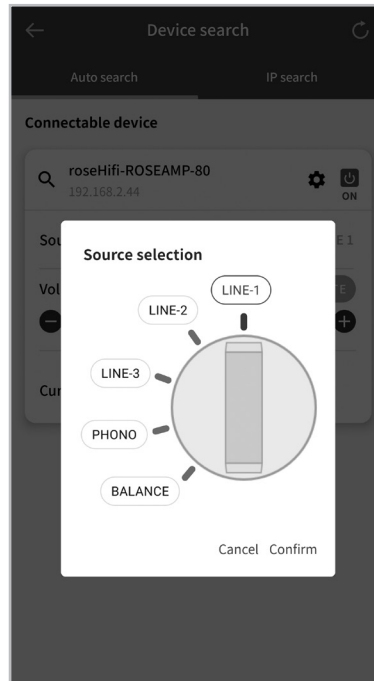

4-3-9. Amplifier Status Display

This shows the current status values of the amplifier.

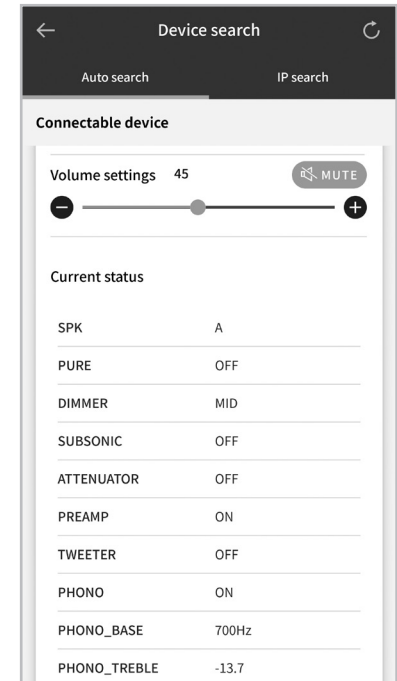

5. Bypass · Power Amplifier Mode

When the Bypass · Power Amplifier Mode switch on the front is turned on, the input source of Line 3 is connected to the power amplifier without going through the preamplifier.

⚠Caution: *At this time, if the signal from the input source is large, it may damage the speaker connected to the product.*

⚠ Caution

If the input level is high when switching to Bypass · Power Amplifier Mode, it may damage the speaker, so please pay attention to the warnings. The company is not responsible for any damage caused by negligence.

Please activate this function in the mobile app before use, and then switch the Bypass · Power Amplifier Mode switch on the main unit from OFF to ON.



Warning!

5-1. How to Use Bypass · Power Amplifier Mode

- To use the power amp mode by turning on Bypass · Power Amplifier Mode, activate the function in the following order.

※ To use this function, the source device must be connected to Line 3.

5-1-1.

In the mobile app, select “Unlock” from the bypass menu in the amplifier settings.

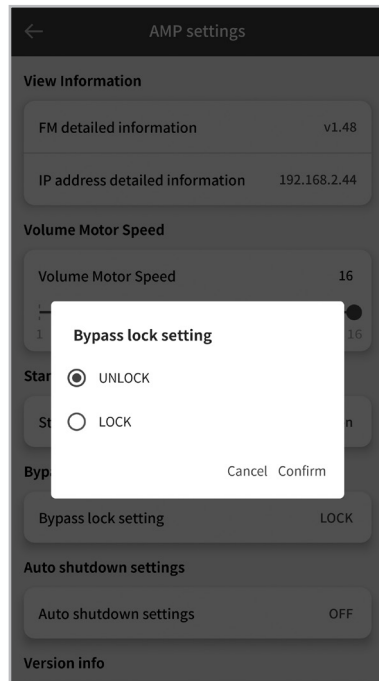

5-1-2.

After fully checking the the warning pop-up, select “OK.”

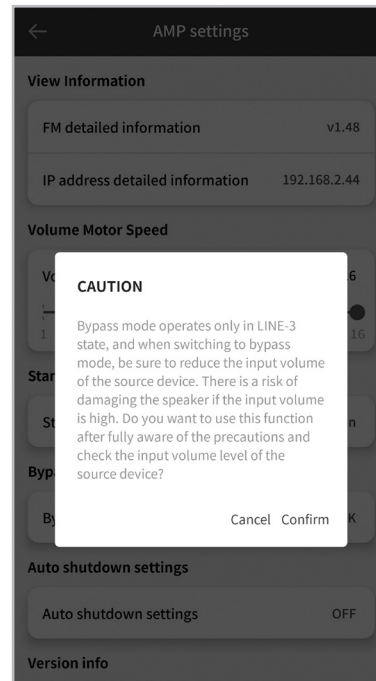

5-1-3.

Lastly, change the Bypass · Power Amplifier Mode switch on the main body to ON to activate this function.

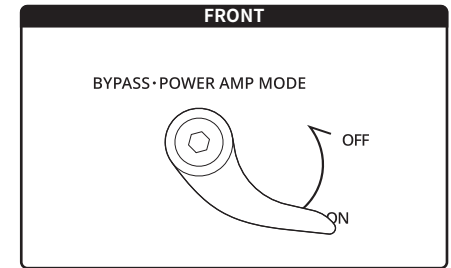

Caution

If the input level is high when switching to Bypass · Power Amplifier Mode, it may damage the speaker, so please pay attention to the warnings. The company is not responsible for any damage caused by negligence.

Please activate this function in the mobile app before use, and then switch the Bypass · Power Amplifier Mode switch on the main unit from OFF to ON.

Product Specifications

1. Specifications

* Maximum output per stereo channel

Item	Condition	Specifications	Measurement Standard
Amplifier Output	4Ω	200W x 4ch (800W)	
	8Ω	200W x 4ch (800W)	
	BTL Mode On	400W x 2ch (800W)	400W x 2ch
Input Sensitivity	Balance Input	2,000mV	200W x 4ch
	Unbalance(Line1,2,3) Input	1,000mV	200W x 4ch
	Phono(MM/MC) Input	5mV / 0.5mV	200W x 4ch
Impedance Input	Balance Input	44kΩ	
	Unbalance(Line1,2,3) Input	47kΩ	
	Phono(MM/MC) Input	47kΩ	
Bandwidth (0dB \pm 3dB/8Ω)	Speaker Output	10Hz ~ 90kHz	100W x 2ch
	H/F Speaker Output	10Hz ~ 90kHz	100W x 2ch
Frequency Respond (1W, 0 \pm 1dB/8Ω)	Speaker Output	10Hz ~ 90kHz	1W x 2ch
	H/F Speaker Output	10Hz ~ 90kHz	1W x 2ch
THD Measure	Balance & Unbalance(Line1,2,3) Input	0.005% (50W)	200W x 4ch
Damping Factor	Speaker & H/F Speaker Output	>150	200W x 2ch
Signal to Noise Ratio Measure (S/N)	BTL / Balanced, Unbalanced / Phono MM, MC	107dB / 105dB / 80dB(MM), 60dB(MC)	200W x 4ch
Impedance Output	Speaker Output	53mΩ	200W x 4ch
Subsonic Filter with On/Off Switch	-3dB	50Hz	1W x 4ch
Tone Control with On/Off Switch	Bass(100Hz) / Treble(10kHz)	\pm 15dB	1W x 2ch (Speaker Output)

X-Over with On/Off Switch	HPF(-3dB)	600Hz ~ 6kHz	1W x 2ch (H/F Speaker Output)
Phono	Turnover	Flat	
		300Hz (+7.7dB@100Hz)	
		400Hz (+11.7dB@100Hz)	
		500Hz (+13dB@100Hz)	RIAA
		700Hz (+14.5dB@100Hz)	
	Roll-off	Flat	
		1.6kHz (-16dB@10kHz)	
		2.1kHz (-13.7dB@10kHz)	RIAA
		3.18kHz (-11dB@10kHz)	
		3.4kHz (-8dB@10kHz)	
		6.36kHz (-5dB@10kHz)	
Design	Size	430(W) X 350(D) X 110(H) (Including feet : 430(W) X 391(D) X 130(H) mm)	
	Weight	16.7kg	
	Body	High Purity Aluminum	
Power	Power	SMPS (800W)	Maximum Output : 1100W
	Voltage	AC100-230V, 50/60Hz	Standby Mode Power Consumption < 0.5W
Audio In/Out on Rear	Trigger	Trigger Voltage Can Be Turned On : 3.3V ~12V	
Remote Control	IR Input	38kHz Infrared Ray (Within 10m of Operating Distance)	

※ Specifications and designs are subject to change without notice for quality improvement.

Appendix

1. Bass Control Function of the Preamp

- If you turn on the tone control on the front of the product and turn the bass knob to the left or right, the bass range is increased or attenuated (in 100 Hz increments), as shown in the figure below.
- It can be adjusted from -15 dB (attenuation) to +15 dB (increase) in 100 Hz/0 dB increments.

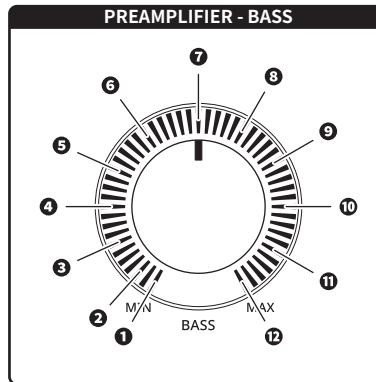

RMS Level

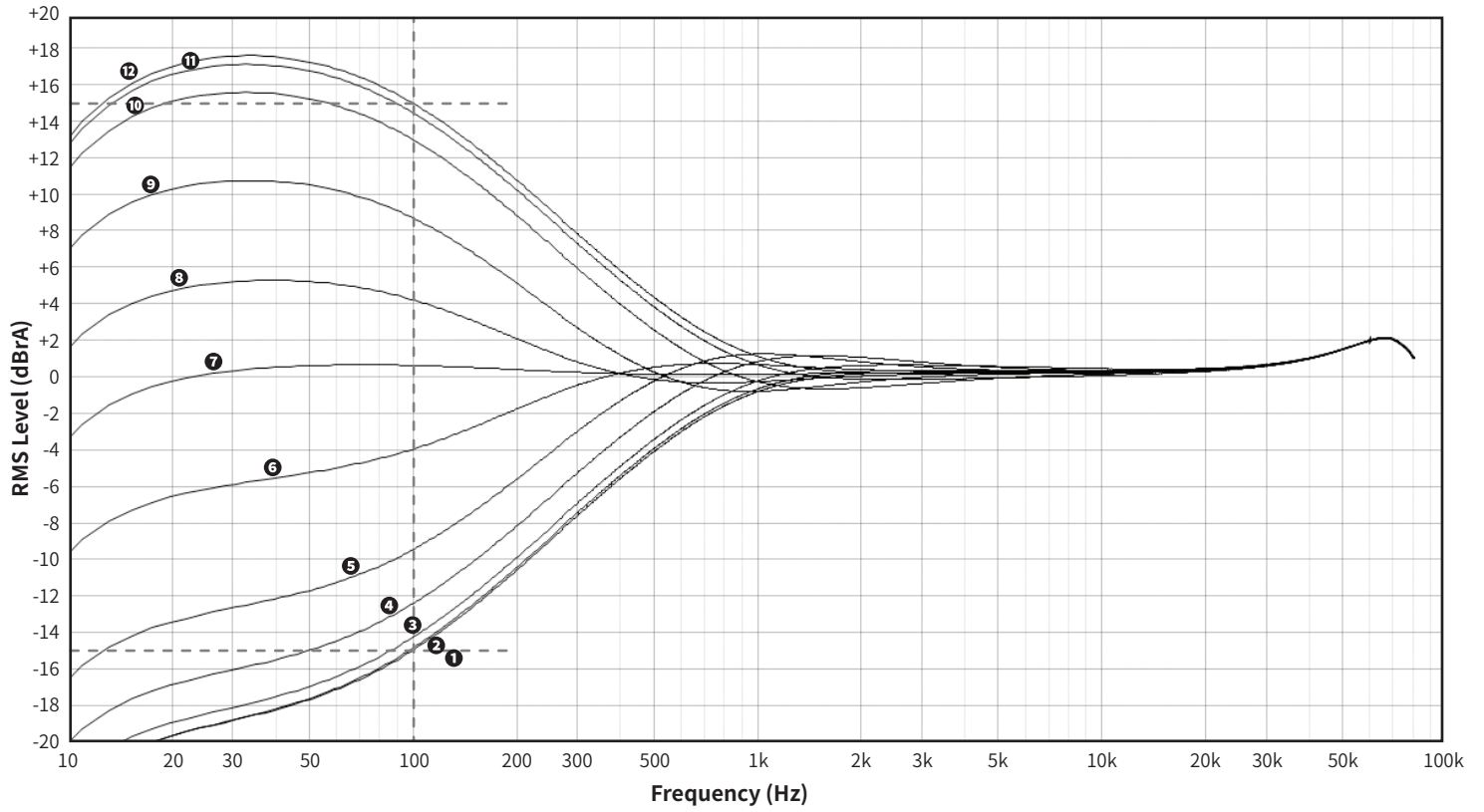

2. Treble Control Function of the Preamplifier

- If you turn on the tone control on the front of the product and turn the treble knob to the left or right, the treble range is increased or attenuated (in 10 kHz increments) as shown in the figure below.
- It can be adjusted from -15 dB (attenuation) to +15 dB (increase) in 10 kHz/0 dB increments.

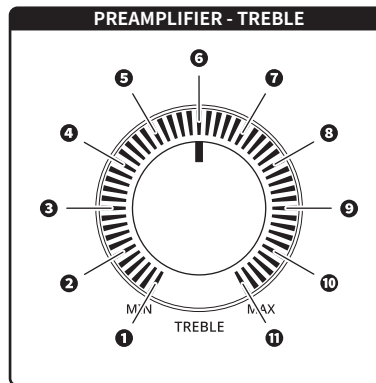

RMS Level

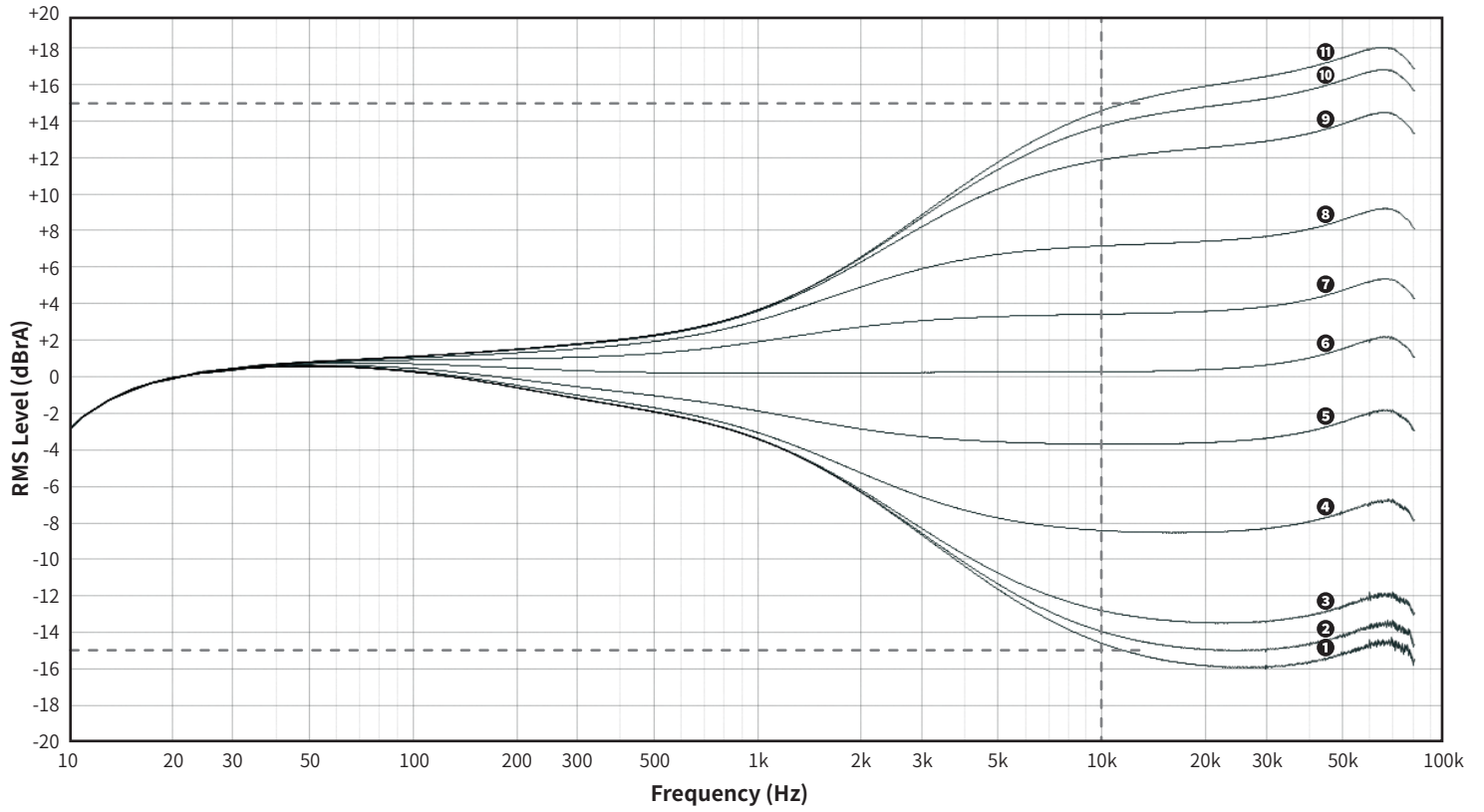

3. HPF Control Function of the H/F Crossover

- When using the bi-amping function, the frequency range sent to the treble area is changed so that the treble can be reproduced more faithfully.
- Speakers with a two-way or more structure have built-in networks inside.
If you set the frequency range below the built-in network crossover value, the network does not send low-range frequencies, so the speaker reproduces treble notes more faithfully.
- The treble frequency range can be varied from 0.58 kHz to 6 kHz based on -3 dB increments.

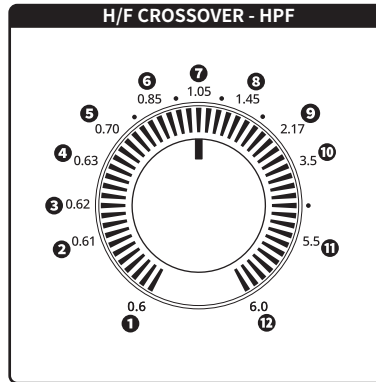

RMS Level

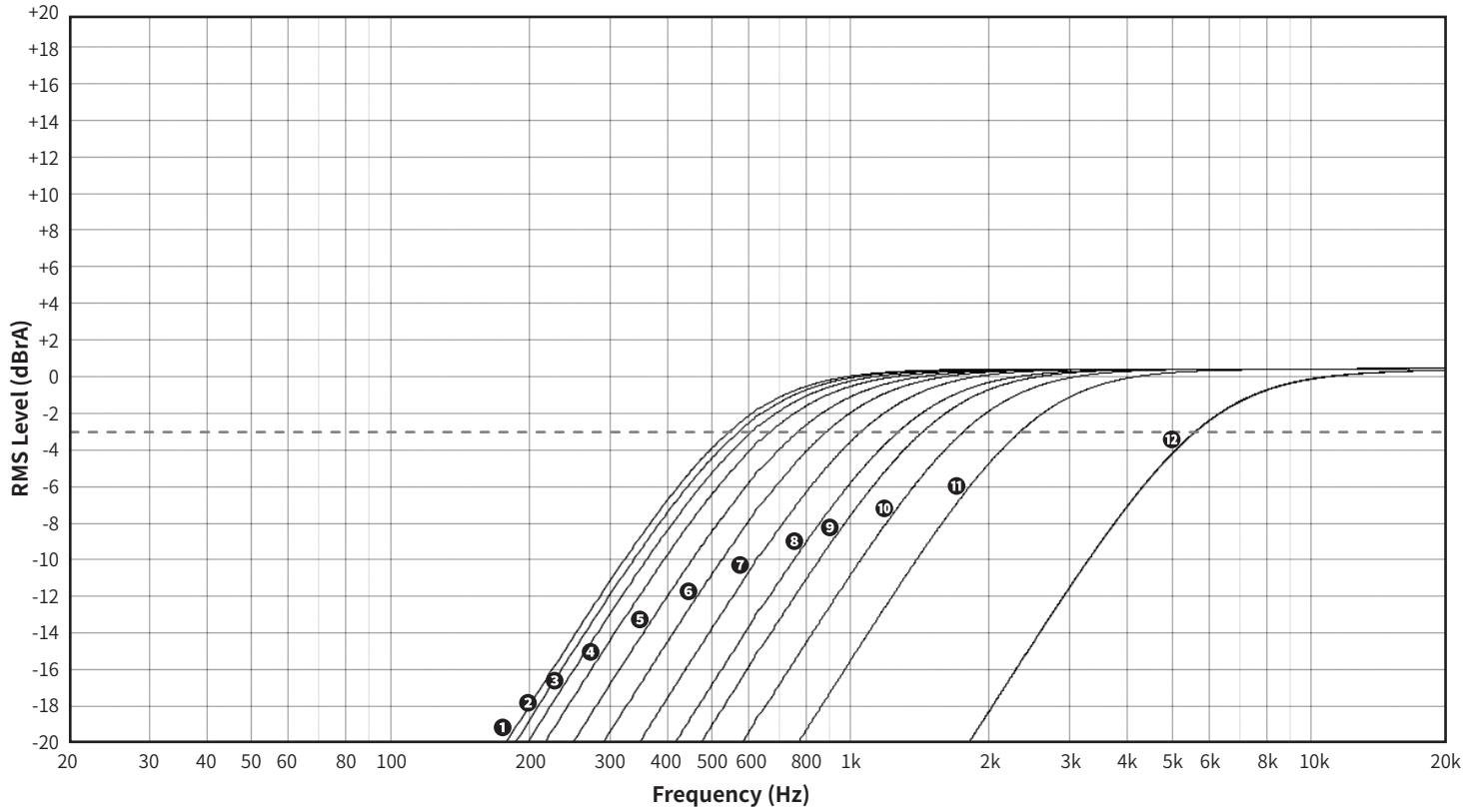

4. Gain Control Function of the H/F Crossover

- This function can attenuate signals in the input treble area when using the bi-amping function by up to -42 dBu.

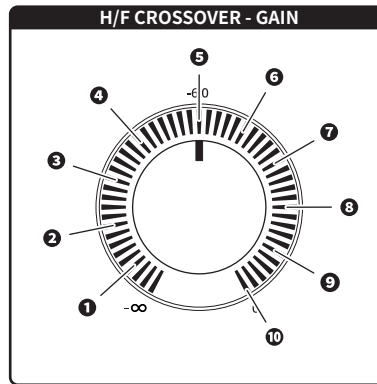

RMS Level

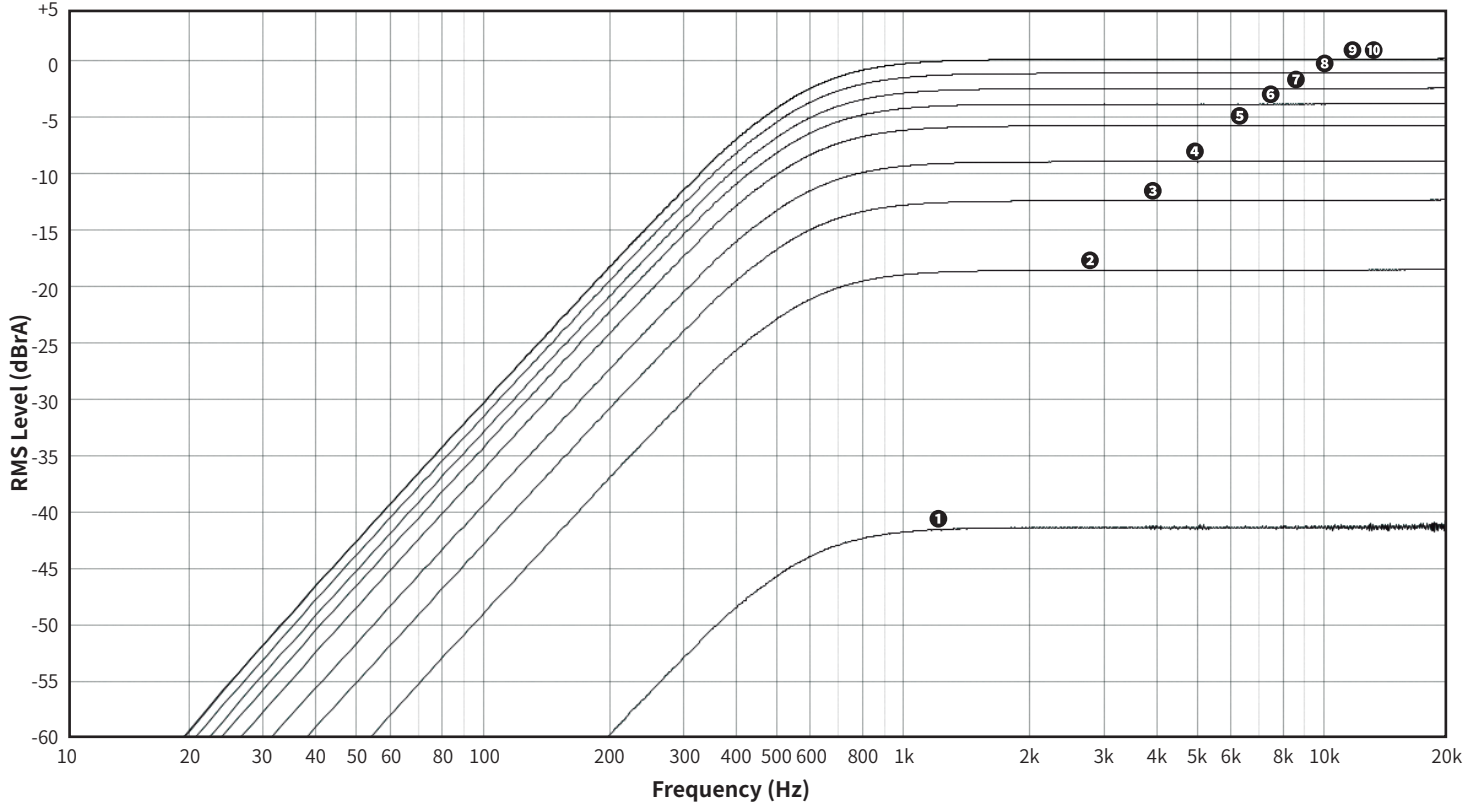

5. Subsonic ON/OFF Function

- When the front subsonic switch is turned on or off, the subsonic is cut based on 50 Hz.

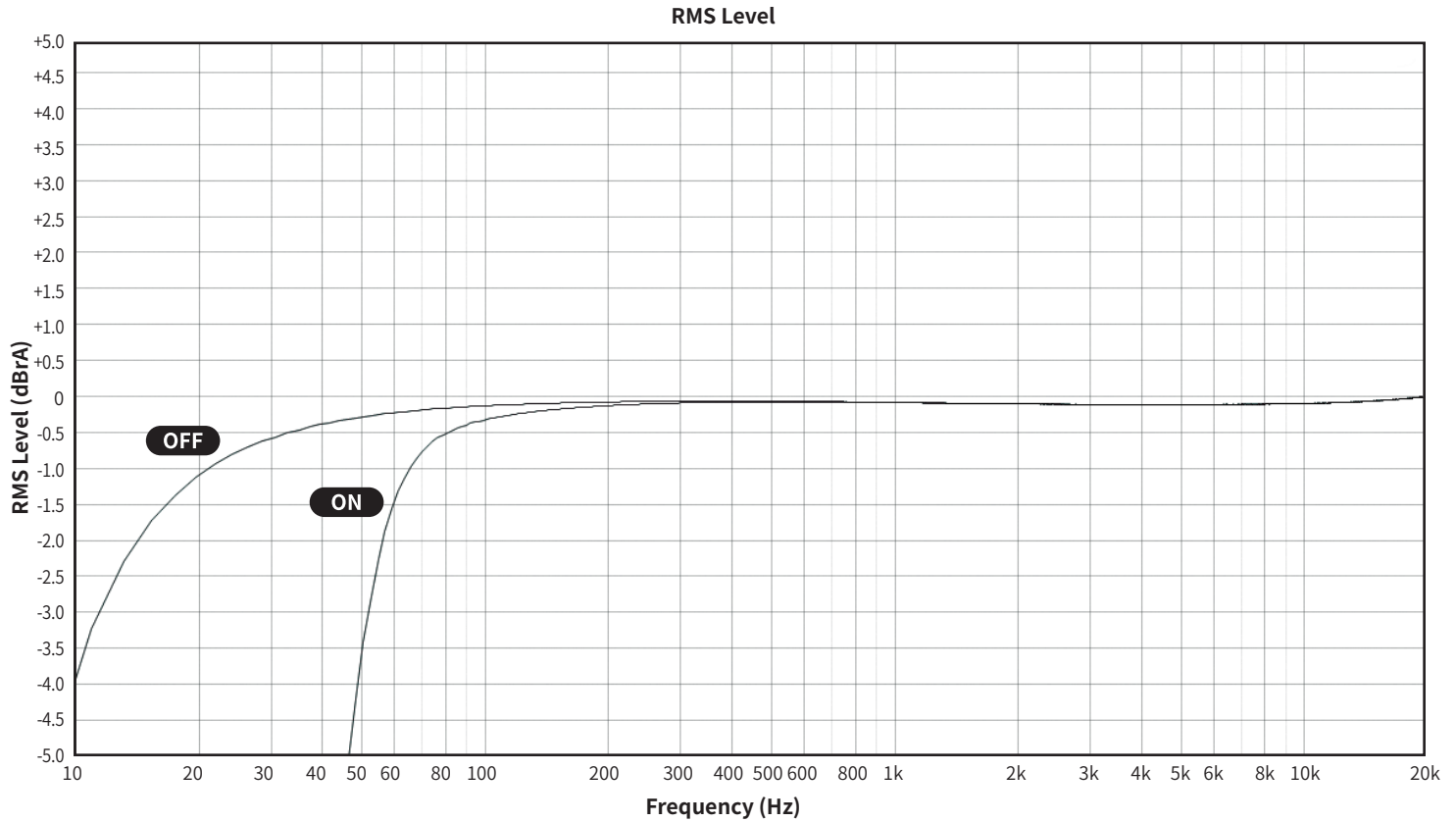

6. Phono Equalizer Curve

- In the case of phono records, since each record label has a different recording method for tape recorders, the low and high frequency characteristics for each record are different, so you need to set the frequency phono equalizer curve value according to the record.

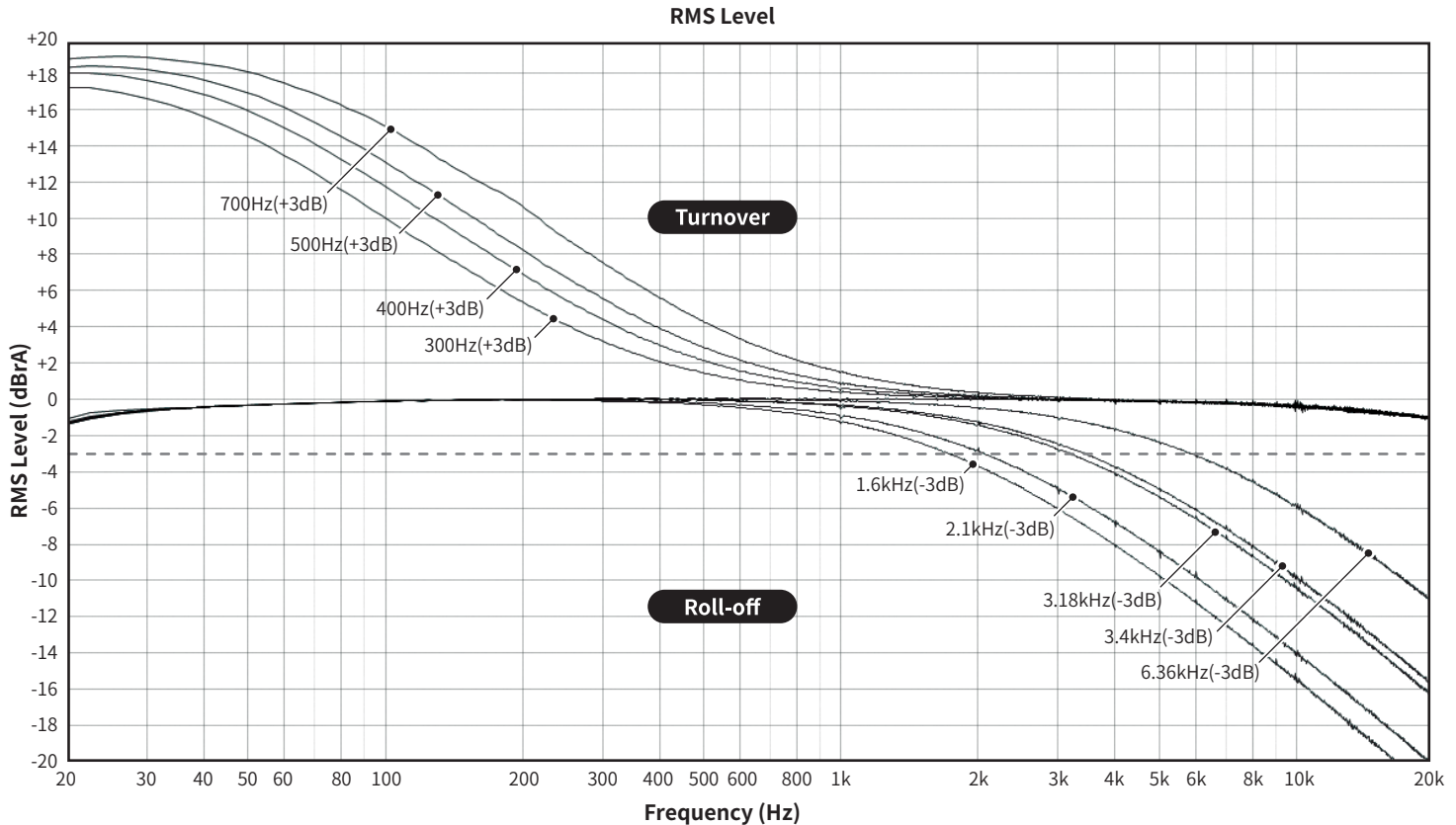

Warranty

Model Name	RA180
Purchase Date	DD / MM / 20YY
Place of Purchase	Shop Name
	Contact Address
Serial No.	
Contact Address	
Warranty Period	Until 1 year from the date of purchase

- Name of the Company that Received the Conformity Assessment: CI TECH Co., Ltd.
- Manufacturer/Country of Manufacture: CI TECH Co., Ltd. / Republic of Korea
- Identification Code of the Certified Company: SYH
- Certification No.: R-R-SYH-RA180

Check Before Contacting the Service Center

- If the switch does not work while the product is in use, it may be because it was exposed to severe static electricity. Please disconnect the power cord before starting again.
- When the product is used for a long time in a confined space that does not meet the product installation conditions (page 22), it may generate heat and become hot, affecting the life and performance of the product.
Always keep the ventilation openings on the top of the main body open so that heat dissipation inside is not disturbed.
- If the transmission is unstable or a transmission or reception failure occurs due to the nature of wireless Wi-Fi communication when using the mobile app, please move to another location and try to reconnect.
- If the main body does not turn on, the power cord may be unplugged. Please check the power plug.
- If there is no output sound, check the input source selector and output selector of the main unit, and check that the speaker connection status, the mute switch, and the volume control level are not “0.”
- If the remote control does not work, the battery may be empty. Replace it with a new battery.

Product Website: www.hifirose.com

- Get news about the latest events and new product information from ROSE through the newsletter.
- You can find an authorized dealer or reseller near you on the website.



* HiFi ROSE is a registered trademark.

