



DR590X-2CH
Manual



ENGLISH

www.blackvue.com

Table of Contents

Introduction	5
Important safety information	6
Overview	9
In the box	9
At a glance	10
Front camera	10
Rear camera	12
Removing and inserting the rear camera	12
Installation	13
Installing the BlackVue dashcam	13
Playing and Managing Videos	19
Playing and managing video files using your smartphone (Android/iOS)	19
Opening video files	19
BLACKVUE WI-FI screen composition	21
Playing video	22
Playing back videos	22
Identify video files by recording type	22
Checking the displayed time & GPS data	23
Real-time streaming video (Live View)	24
Managing videos	25
Managing videos in Wi-Fi	25
Copy to Internal Memory	25
Managing videos in INTERNAL MEMORY	26
Deleting videos	27
Creating a new folder	28
Deleting a folder	28
Copying and pasting videos	28
Moving videos	29
Renaming a video	29

Playing and managing video files using your computer (Windows/macOS)	30
Removing the microSD card	30
Opening video files in BlackVue Viewer	31
Viewer screen composition (Windows/macOS)	32
Playing video	33
Playing back videos	33
Identify video files by recording type	33
Checking the displayed time	33
Using BlackVue Viewer	34
Exploring the timeline and G-Sensor graph	35
Zoom options	36
Checking the GPS data	37
Managing videos	38
Capturing or printing a still image from video	38
Deleting videos	38
Exporting videos	39
Copying videos	40
Tips for optimal performance	41
Formatting the microSD card	41
Format using BlackVue Viewer (Windows)	41
Format using BlackVue Viewer (macOS)	42
Upgrading the firmware	44
Upgrading the firmware using an iOS or Android device (Firmware Over The Air)	44
Upgrading the firmware using a computer (Windows/macOS)	47
Changing settings	49
Changing settings using your smartphone (Android/iOS)	49
Basic settings	50
Time settings	51

Video settings	53
Resolution	53
Image quality	54
Enhanced night vision	54
Brightness (Front)	54
Brightness (Rear)	54
Recording settings	55
Normal recording	55
Parking mode recording	55
Rear camera recording in parking mode	56
Voice recording	56
Date & time display	56
Speed unit	56
Video segment length	56
Lock event files	56
Front camera rotation	57
Rear camera orientation	57
Sensitivity settings	58
G-Sensor (Normal mode) / G-Sensor (Parking mode)	59
Motion detection (Parking mode)	60
System settings	61
LED	61
Recording status	61
Front security (Normal mode)	61
Front security (Parking mode)	61
Rear security	61
LTE (Parking mode)	62
Wi-Fi (Parking mode)	62
Voice guidance	62
Impact detected in parking mode	62
Volume	62
Scheduled Reboot	62
Speed alert	62
Battery Protection (Optional - Hardwiring Power Cable installation only)	63
User text overlay	63
Wi-Fi settings	64
Login credentials	64
Wi-Fi auto turn off	64

Cloud settings	65
Enable Cloud Lite service	65
Push notification settings	66
FW Language	67
Changing settings using your computer (Windows/macOS) ..	68
BlackVue Viewer settings	69
Select language	69
Speed unit on map	69
Select map service	69
Picture-in-picture(PIP) playback	69
Firmware settings	70
Basic settings	71
Time settings	71
Video settings	72
Recording settings	73
Sensitivity settings	75
G-Sensor (Normal mode) / G-Sensor (Parking mode)	75
Motion detection (Parking mode)	76
Advanced sensitivity settings for normal and parking mode	76
System settings	78
LED	78
Voice guidance	79
Volume	79
Scheduled Reboot	79
Speed alert	80
Battery Protection (Hardwiring Power Cable installation only)	80
User text overlay	80
Wi-Fi settings	81
Login credentials	81
Wi-Fi auto turn off	81
Push notification settings	82
Applying the settings	82

About the Cloud Service	83
Connect to BLACKVUE CLOUD (Optional)	83
Optional accessories	88
Parking mode battery (Optional)	88
Power Magic Battery (B-112)	88
Power Magic Ultra Battery (B-124X).....	89
External connectivity module (Optional)	90
Troubleshooting	91
Changing / resetting direct Wi-Fi SSID and password	91
On-device Wi-Fi SSID and password reset.....	91
Change Wi-Fi SSID and password over the Cloud.....	92
Change the Wi-Fi password using BlackVue Viewer (Windows/macOS)	94
Product specifications.....	95
Recording time	97
Disposal and recycling information.....	98

Introduction

Thank you for purchasing this BlackVue dashcam made by Pittasoft Co., Ltd.

This instruction manual contains information on how to operate your dashcam.

Before using your dashcam, we recommend that you read through this manual to ensure correct usage.

To improve the performance of the product, the contents of this manual are subject to change without prior notice.

Note

- A formatted microSD card is provided with the BlackVue dashcam when you purchase the product. Insert the microSD card in the dashcam and power it up. The microSD card will be initialized.

Important safety information

For user safety and to avoid property damage, read through this manual and follow these safety instructions to use the product correctly.



DANGER

Failure to observe the following directions could result in death or property damage:

- **Do not disassemble, repair, or modify the product yourself.**
Doing so may cause fire, electric shock, or malfunction. For internal inspection and repair, contact the service center.
- **If any foreign matter gets inside the product, detach the power cord immediately.**
Contact the service center for repair.
- **Do not adjust the product while driving.**
Doing so may cause an accident. Stop or park your car in a safe place before installing and setting up the product.
- **Do not install the product in a location where the product can interfere with the driver's field of vision.**
Doing so may cause an accident.
- **Do not use a damaged or modified power cord. Only use the cords provided by the manufacturer.**
Damaged or modified power cords may cause an explosion, fire, or malfunction.
- **Do not operate the product with wet hands.**
Doing so may cause electric shock.
- **Do not install the product in an environment with high humidity, or combustible gases or liquids.**
Doing so may cause an explosion and/or fire.



WARNING Failure to observe the following directions could result in death or serious injury:

- **Do not leave the product near infants, children, or pets.**

There is a risk of them swallowing small components, and/or their saliva may get into the product, causing an explosion due to a short circuit.

- **Do not spray water or wax directly onto the product while cleaning the inside of the car.**

Doing so may cause fire, electric shock, or malfunction.

- **If smoke or an unusual smell is emitted from the power cord, detach the power cord immediately.**

Contact the service center or your distributor.

- **Keep the terminals of the power cord clean.**

Failure to do so may cause excessive heat and fire.

- **Use the correct input voltage.**

Failure to do so may cause explosion, fire, or malfunction.

- **Plug in the power cord firmly so that it cannot easily be disconnected.**

Failure to do so may cause fire.

- **Do not cover the product with any material.**

Doing so may cause external deformation of the product or fire. Use the product and peripherals in a well-ventilated location.

**CAUTION**

Failure to observe the following directions could result in injury or property damage:

- **Do not spray cleaning products directly onto the product.**
Doing so may cause discoloration, cracks, or malfunction.
- **If the product is used outside the optimal temperature range (-20°C – 85°C / -4°F – 185°F), performance can decline or malfunctions may occur.**
- **Make sure that the product is installed properly.**
If installed incorrectly, vibrations may cause the product to fall, and may cause physical injury.
- **When entering or exiting a tunnel, when directly facing into bright sunlight, or when recording at night without lighting the quality of recorded video may deteriorate.**
- **If the product is damaged or the power supply is cut due to an accident, video may not be recorded.**
- **Excessively tinted windshield glass can distort the recorded video or cause recorded video to be indistinct.**
- **Prolonged use of the product can increase the interior temperature and cause burns.**
- **microSD cards are consumables, so replace microSD cards after prolonged use.**
microSD cards may not record video correctly after extended use, so check the microSD card's recording capability periodically and replace as necessary.
- **Clean the lens regularly.**
Foreign material attached to the lens can affect the recording quality.
- **Do not remove the microSD card while the microSD card is saving or reading data.**
The data can be damaged or malfunctions may occur.
- **It is recommended that you install the software and firmware from the BlackVue downloads page (www.blackvue.com).**
- **It is recommended that you remove the power cord if the product (BlackVue dashcam/Parking Mode Hardwiring Kit) is not used for an extended period of time.**

In the box

Check the box for each of the following items before installing the BlackVue dashcam.

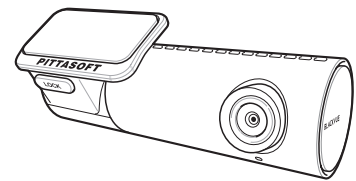

Front camera

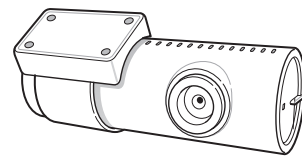

Rear camera

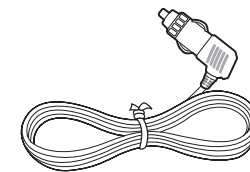

Cigarette lighter power cable

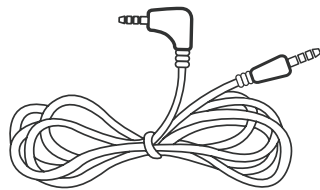

Rear camera connection cable



Quick start guide



Cable clips (5 EA)



microSD card



microSD card adapter

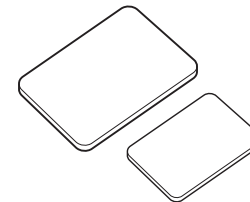

Double-sided tape for the Mounting Brackets

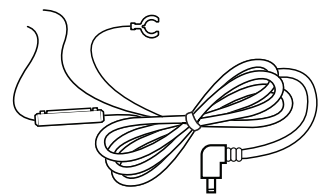

Hardwiring power cable (Optional)

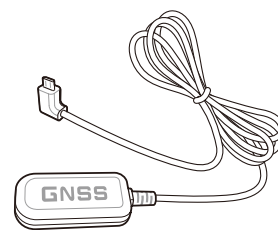

External GPS - USB Type (Optional)

Note

- The illustrations in this manual may differ from the product.
- To improve the performance of the product, the contents of this manual are subject to change without prior notice.
- For more information about the package components and accessories, visit the BlackVue website (www.blackvue.com).

➤ At a glance

The following diagrams explain each part of the BlackVue dashcam.

□ Front camera

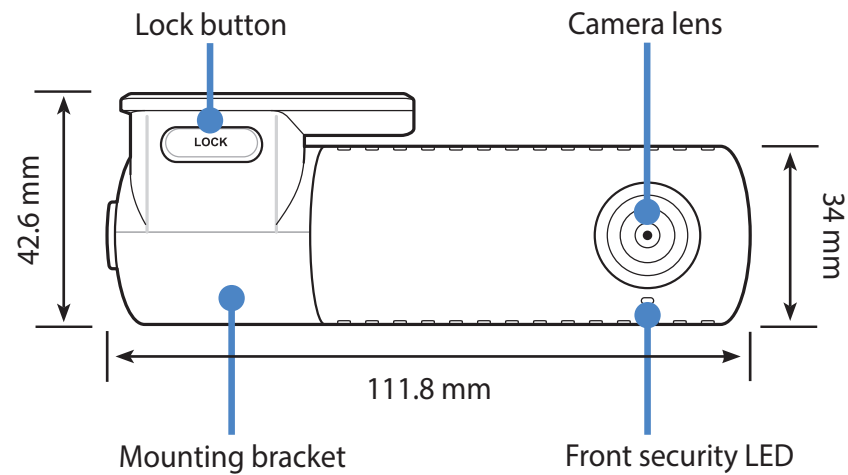

- : Lights on during (i) normal mode, (ii) an event is being recorded (impact detected), (ii) manual recording has started, or (iv) motion is detected in parking mode.
- ◻: Blinks slowly during parking mode motion detection standby.

Recording LED

- : Lights orange in normal mode.
- : Lights red when (i) an event is being recorded (impact detected), or (ii) manual recording has started.
- : Lights green in parking mode when motion is detected.

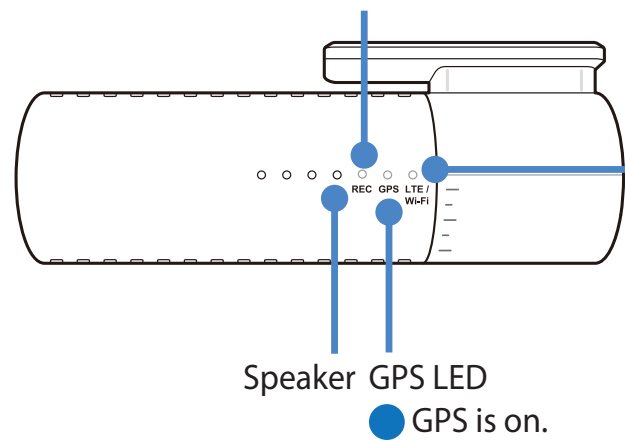

- : Lights yellow when Cloud is connected.
- : Lights white when Wi-Fi is connected.
- ⊙: Blinks quickly when LTE/Wi-Fi is turning off.

- : GPS is on.

□ Removing and inserting the front camera

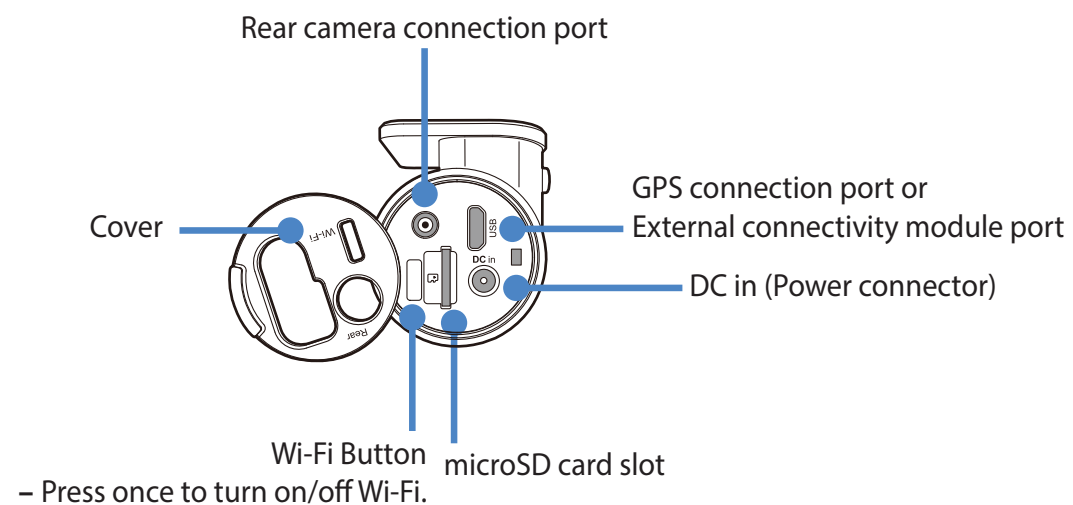

- To remove the dashcam from its bracket, press the LOCK button and pull the dashcam out of the mounting bracket.
- To insert the dashcam into its bracket, push the dashcam into the mounting bracket until it "clicks" in.

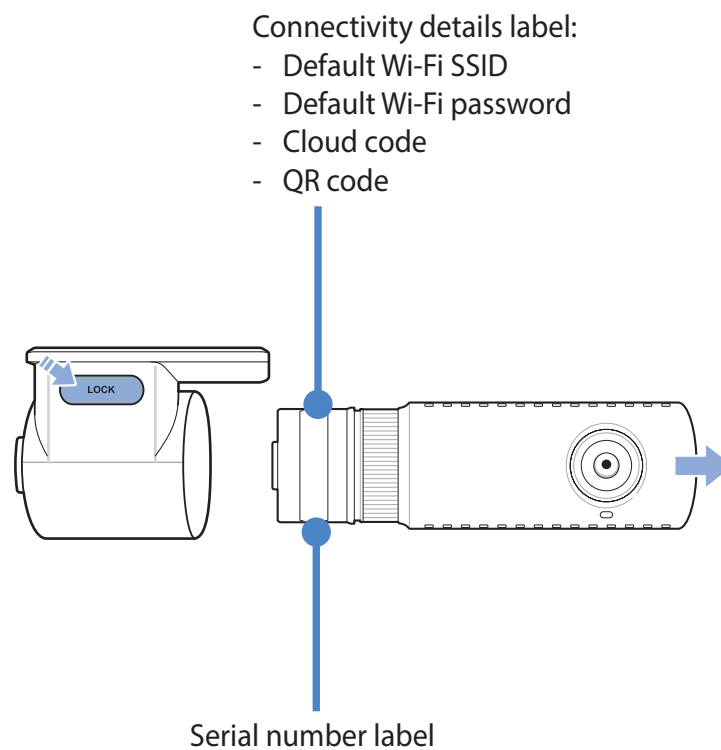

□ Rear camera

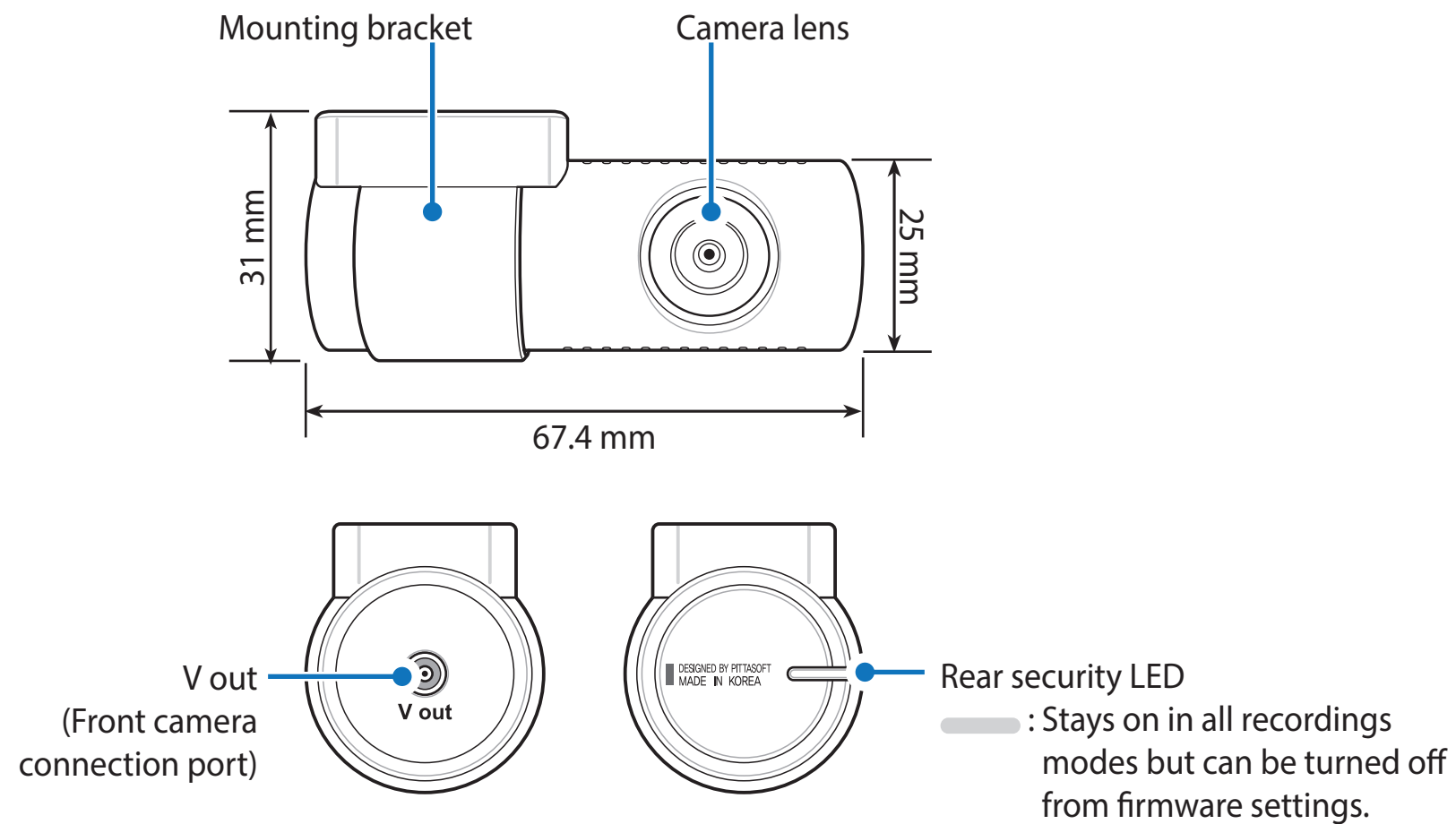

□ Removing and inserting the rear camera

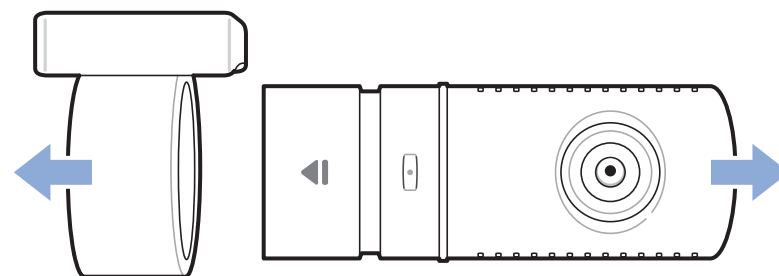

- To remove the rear camera from its bracket, hold the mounting bracket and pull the rear camera out.
- To insert the rear camera into its bracket, push the rear camera into the mounting bracket until it "clicks" in.

▶ Installing the BlackVue dashcam

Install the front camera behind the rear view mirror. Install the rear camera at the top of the back windshield. Remove any foreign matter and clean and dry the windshield before installation.

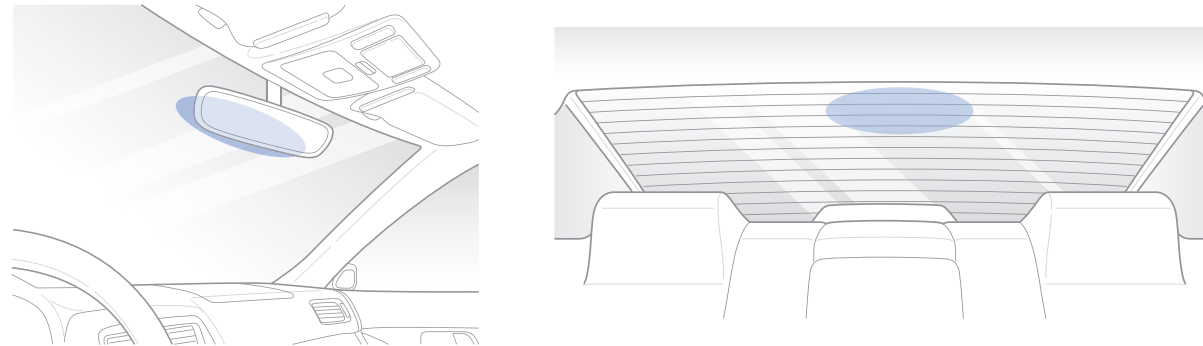

Warning

- Do not install the product in a location where it can obstruct the driver's field of vision.

1

Turn off the engine. Open the cover of the microSD card slot, gently push the card into the slot until it locks into place and close the cover.

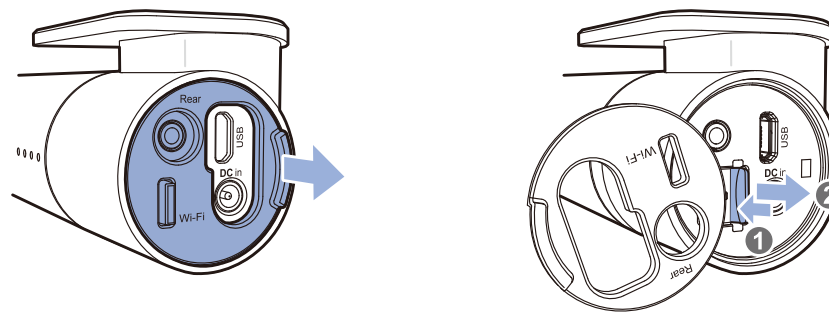

- 2** Peel off the protective film from the double-sided tape and attach the front camera to the windshield behind the rear-view mirror.

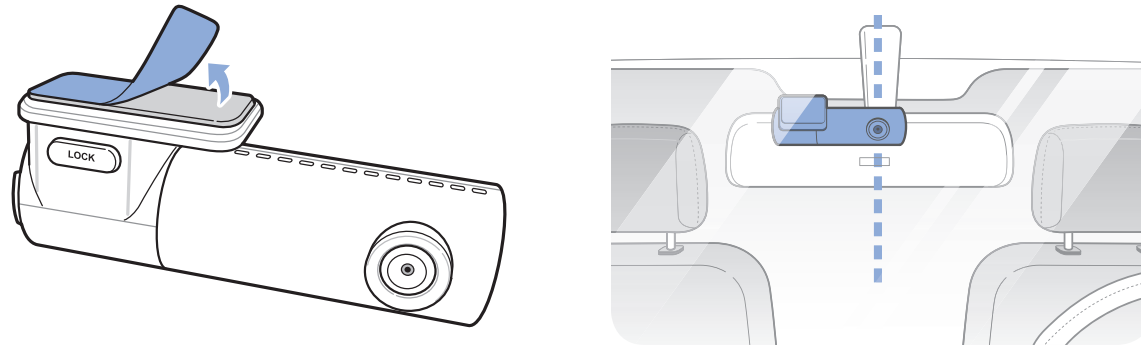

- 3** Adjust the angle of the lens by rotating the body of the front camera. We recommend pointing the lens slightly downwards ($\approx 10^\circ$ below horizontal), so as to record video with a 6:4 road to background ratio.

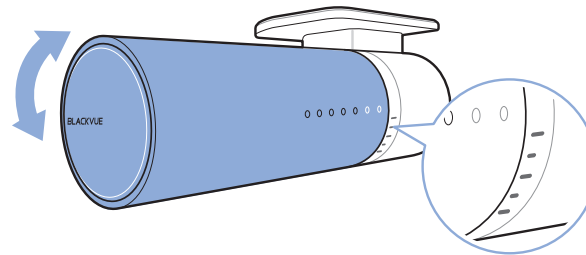

- 4** Peel off the protective film from the double-sided tape and attach the rear camera to the rear windshield. Adjust the angle of the lens by rotating the body of the rear camera.

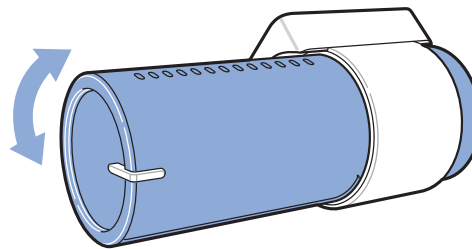

5 Connect the front camera ('Rear' port) and the rear camera ('V out') using the rear camera connection cable.

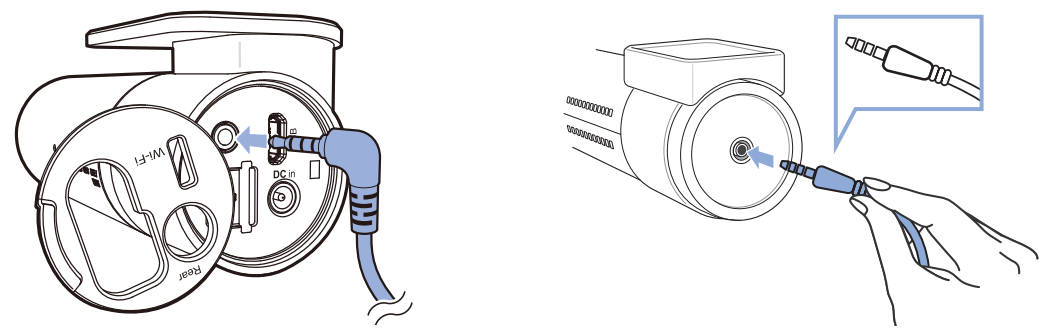

6 Use the pry tool to lift the edges of the rubber window sealing and molding and tuck in the rear camera connection cable.

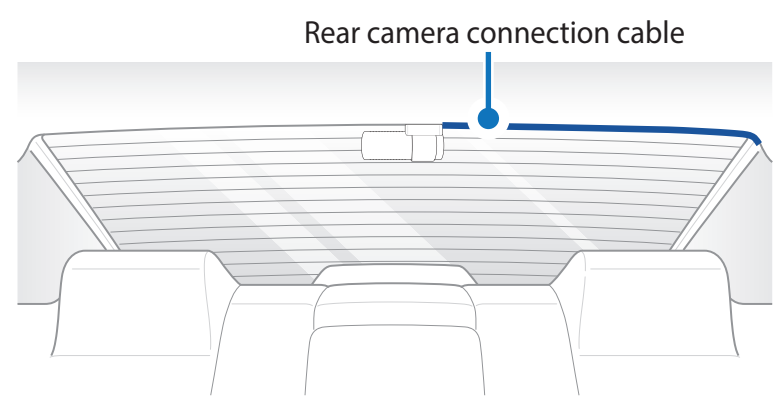

7 GPS receiver or connectivity module (Optional):
Plug in the GPS receiver or connectivity module and attach it in a corner of the windshield. Use the pry tool to tuck in the cable.

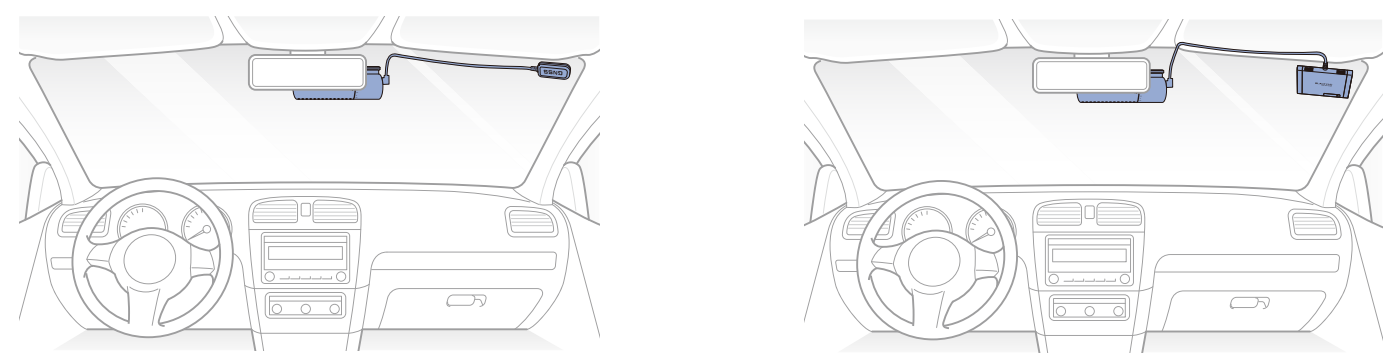

- 8 Plug the cigarette lighter power cable into the cigarette lighter socket and the front camera. Skip to 12 for Hardwiring Power Cable setup.
- 9 Use the pry tool to lift the edges of the windshield trim/molding and tuck in the power cord.

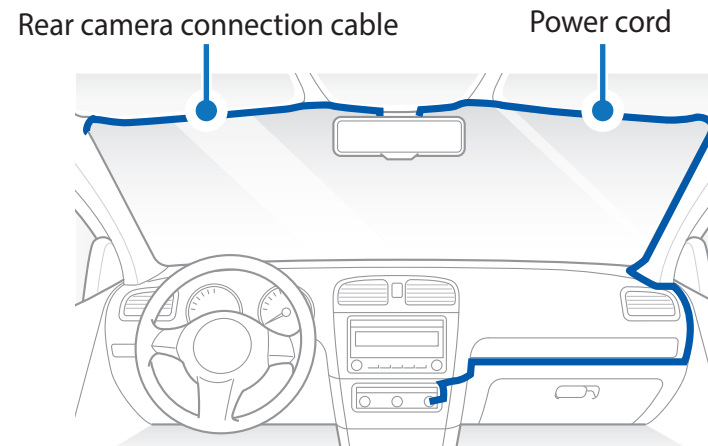

- 10 Turn on the engine. The BlackVue dashcam will power up and start recording. Video files are stored on the microSD card.
- 11 Turn off the engine. The dashcam will automatically stop recording and power down. To record in parking mode while the engine is off please connect the Hardwiring Power Cable (Optional) or install a **Power Magic Battery Pack** (sold separately). A **Hardwiring Power Cable** (Optional) uses the automotive battery to power your dashcam when the engine is off. A low voltage power cut-off function and a parking mode timer to protect the automotive battery from discharge is installed in the device. Settings can be changed in the BlackVue App or Viewer.
- 12 Locate the fuse box to connect the hardwiring power cable.

 **Note**

- Location of the fuse box differ by manufacturer or model. For details, refer to the vehicle owner's manual.

12-1 After removing fuse panel cover, find a fuse that powers on when engine is turned on (ex.cigarette lighter socket, audio, etc) and another fuse that remains powered on after the engine is turned off (ex.hazard light, interior light). Connect the ACC+ cable to a fuse that powers on after engine start, and BATT+ cable to a fuse that remains powered on after engine is turned off.

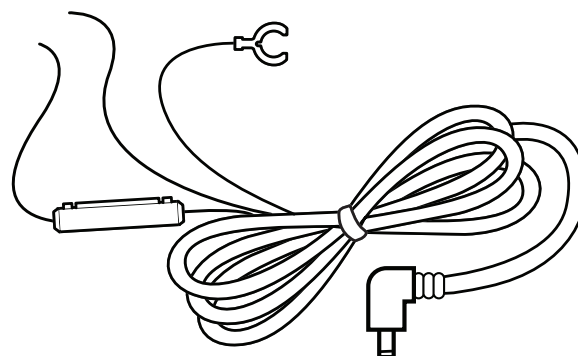

Note

- To use battery saver feature, connect the BATT+ cable to the hazard light fuse. Functions of fuse differ by manufacturer or model. For details, refer to the vehicle owner's manual.

12-2 Connect the GND cable to metal ground bolt.

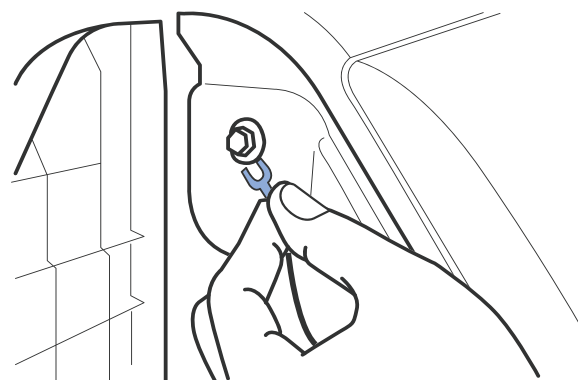

13 Connect the power cable to the DC in terminal of the front camera. BlackVue will power up and start recording. Video files are stored on the microSD card.

 **Note**

- Up to 50 event recordings (impact, manual) can be locked from being overwritten. By default, this feature is enabled. In the firmware settings, you can choose to either overwrite them with new event files when the event file storage is full or lock the 50 event files and save the new event files in loop recording storage. Please note that formatting the microSD card deletes all the recordings including the locked event files.
- The recording LED is on while recording (default setting) and the GPS LED is on when a GPS signal is received. There are 4 recording modes: Normal, Event, Parking and Manual. The dashcam starts recording in normal mode, switches to event mode when an impact is detected, and switches to parking mode when the vehicle is turned off (Hardwiring power cable, ACC+) or stationary for 5 minutes (Cigarette lighter power cable, G-sensor).
- When you run the dashcam for the first time the firmware is automatically loaded onto the microSD card. After the firmware has been loaded onto the microSD card you can customize settings using BlackVue Viewer on a computer.

▶ Playing and managing video files using your smartphone (Android/iOS)

▶ Opening video files

- 1 Search for the BlackVue app in the Google Play Store or Apple App Store and install it on your smartphone.
- 2 “Pair” your smartphone with the BlackVue dashcam via direct Wi-Fi:
 - a. Press the Wi-Fi button once to turn on Wi-Fi.
 - b. Go to your smartphone's **Settings** then select **Wi-Fi**, and make sure Wi-Fi is turned on.

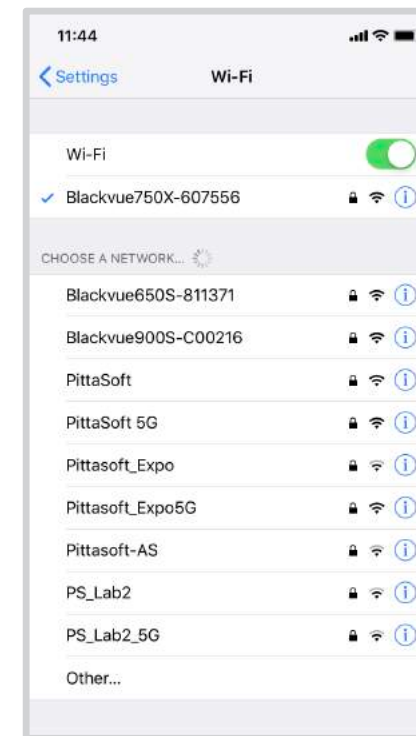
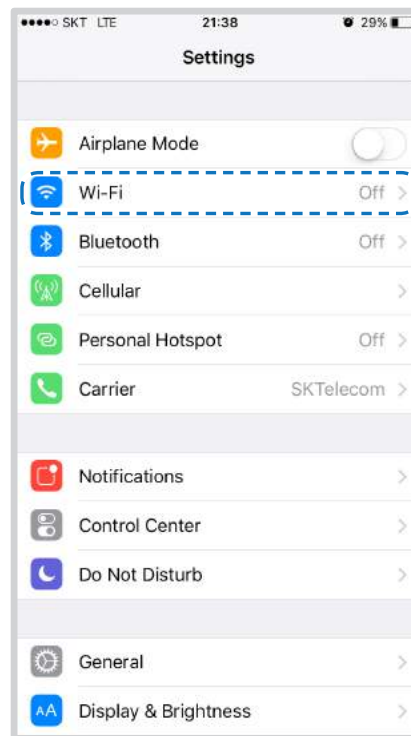
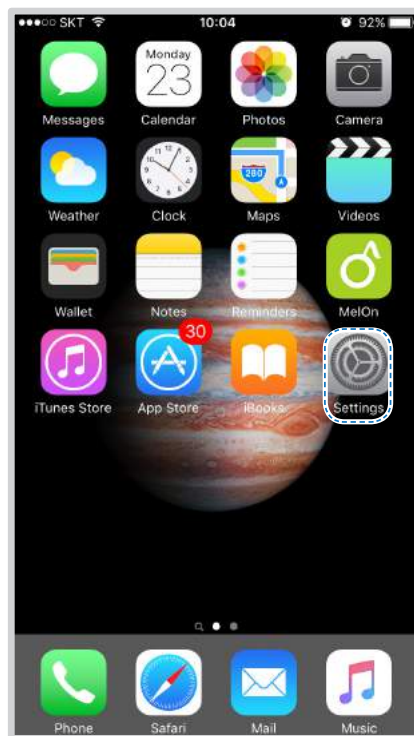

- c. Choose your BlackVue dashcam from the network list. The dashcam's default SSID begins with its model number (e.g. BlackVue590X-*****).
- d. Enter the password and tap join.
- * The default Wi-Fi SSID and password is labeled on the dashcam. To find them, unplug the cables and remove the front camera from its mount.
- e. Open the BlackVue app and select Wi-Fi.

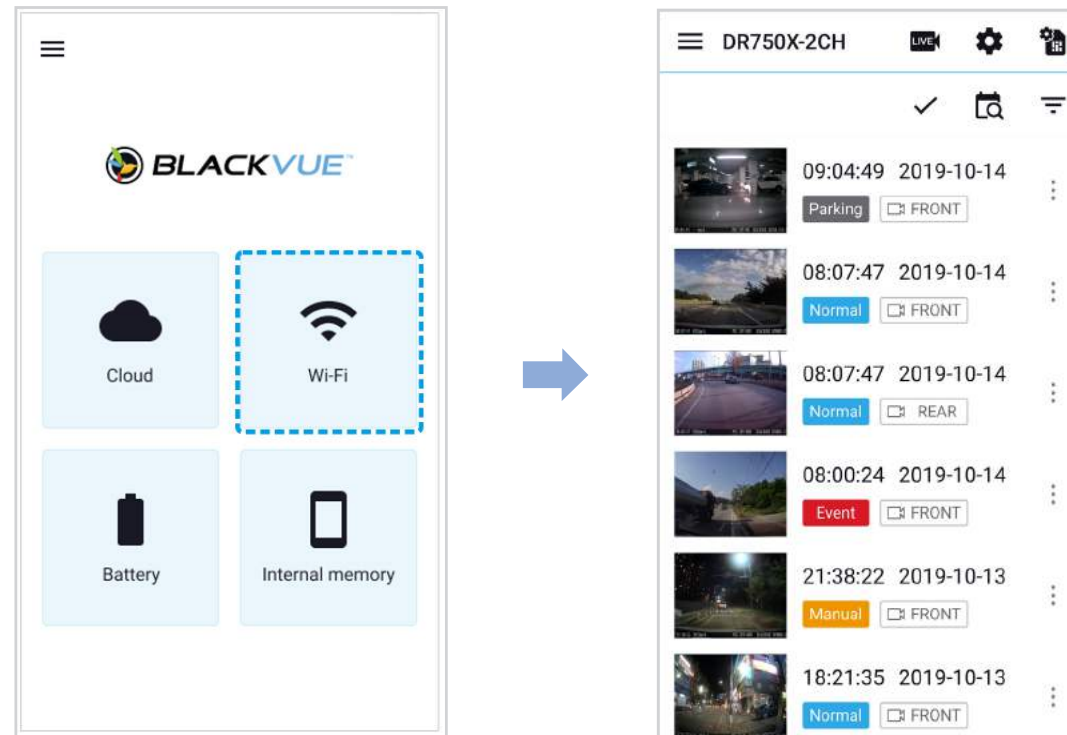

- f. Select the video file you want to play from the video list.

Note

- Direct Wi-Fi lets you directly connect your smartphone to your dashcam via Wi-Fi within a range of 10m.
- The BlackVue app is available for devices running Android 5.0 and higher, or iOS 9.0 and higher.
- You can change Wi-Fi SSID and password as described on page **92** and **94**.

▶ BLACKVUE WI-FI screen composition

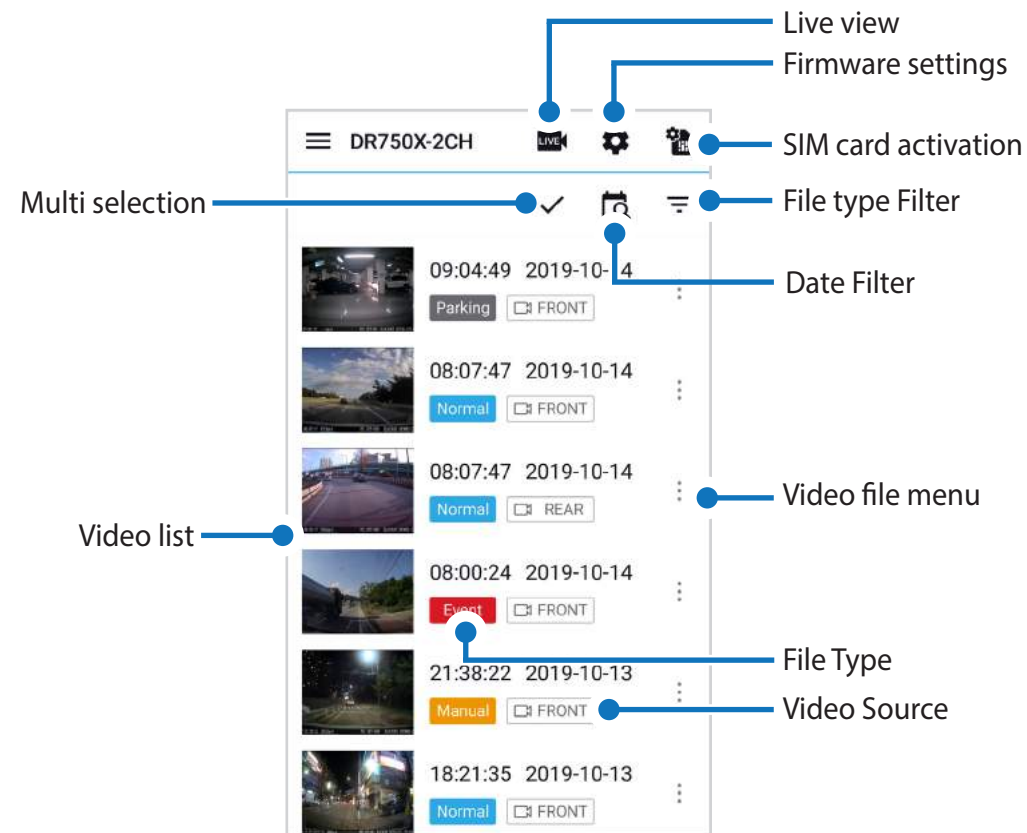

Note

- All images shown are for illustration purpose only. Actual app may differ from images shown.

Playing video

Playing back videos

Select the video file you want to play from the video list.

Scroll up/down the screen to refresh the video list.

Identify video files by recording type

Normal	Normal	The dashcam records in normal mode by default.
Event	Event	When the dashcam detects an impact while in normal or parking mode, it switches to event mode and saves an event recording beginning 5 seconds before the event trigger. Exceeding the set speed limit will also trigger an event recording.
Parking	Parking	In parking mode the dashcam continuously buffers video. When motion is detected in the dashcam's field of view, it saves a parking recording beginning 5 seconds before the motion detection.

Note

- The dashcam requires a constant power source to record in parking mode. See "**Optional accessories**" on **page 88** for more information.

☐ Checking the displayed time & GPS data

The time the video was recorded is displayed in the lower left corner of the video in the playback screen. If the displayed time in the recorded videos is incorrect please see **"Time settings" on page 51 or 71.**

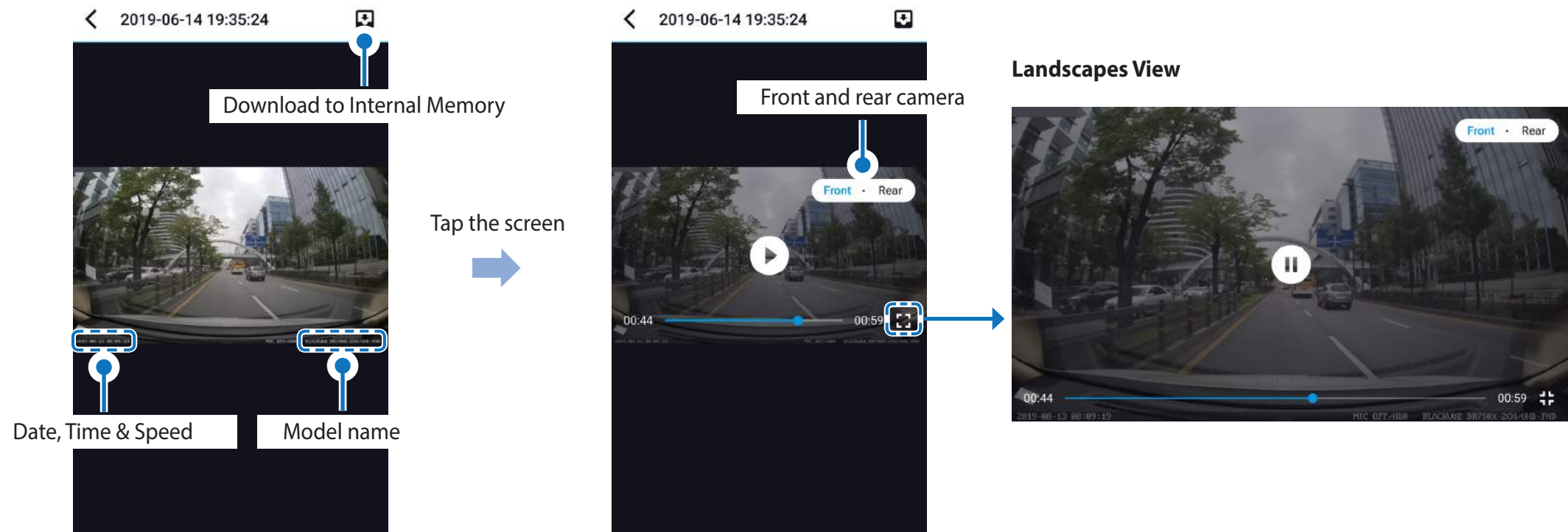

The vehicle's speed is displayed in the lower-left corner of the video.

Tap the screen to playback the video.

Rotate your smartphone to switch between portrait and landscape display modes.

You can switch the dashcam view by pressing the Front/Rear button.

➤ Real-time streaming video (Live View)

You can view in real-time the video currently being recorded by connecting your smartphone to the dashcam via direct Wi-Fi.

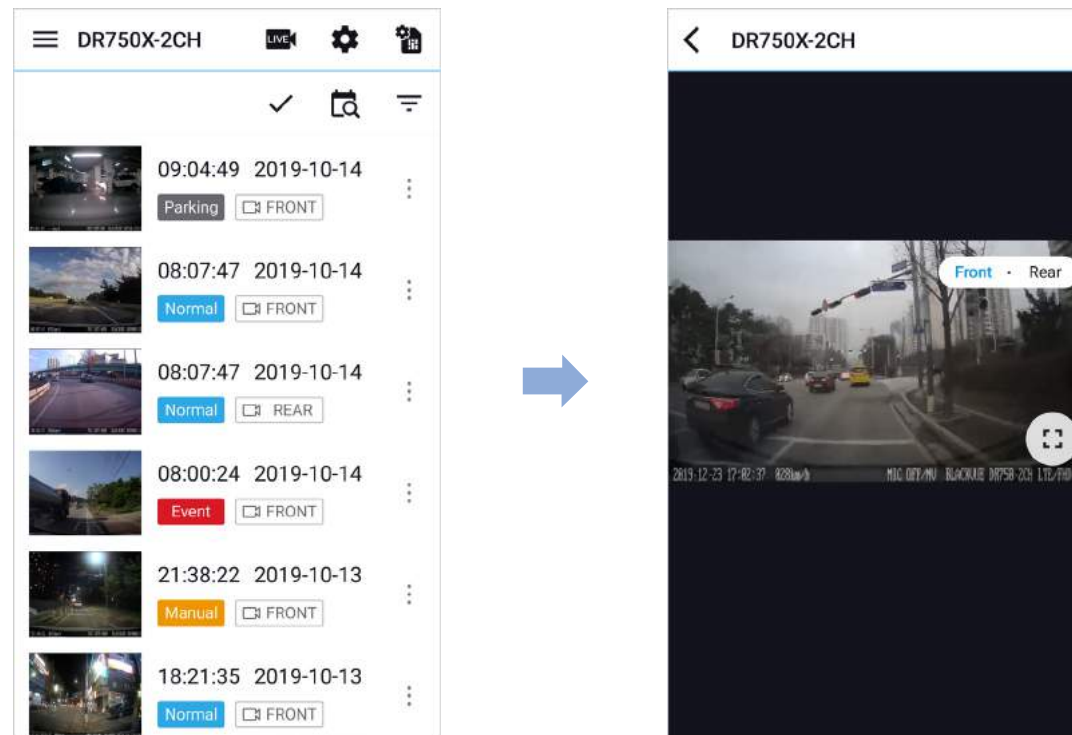

- 1 Go to your smartphone's **Settings** > **Wi-Fi** and connect to your dashcam.
- 2 Open the BlackVue app. Select **WI-FI** and tap the **LIVE** button.
- 3 Rotate your smartphone to switch between portrait and landscape display modes.
- 4 You can switch the dashcam view by pressing the Front/Rear button.

Note

- When watching Live View via direct Wi-Fi, map data isn't displayed because your smartphone can't access internet as long as it is connected to dashcam's Wi-Fi.

➤ Managing videos

☐ Managing videos in Wi-Fi

You can manage the recorded videos using the BlackVue app.

📝 Note

- When the microSD card fills up, the newest video files will start to replace the oldest video files (called loop recording) – so you will always have the most recent video files.

■ Copy to Internal Memory

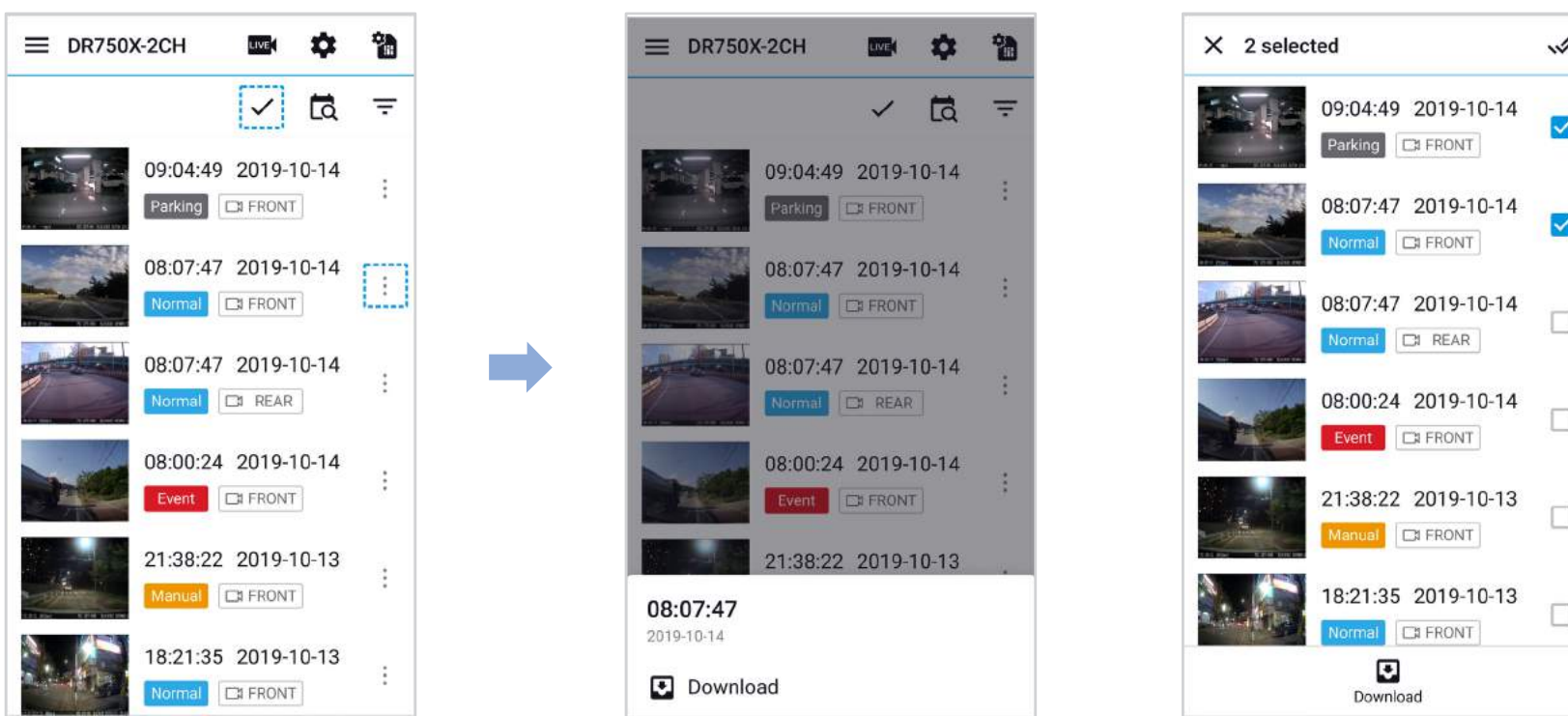

To copy individual files to your smartphone, tap  next to the video you want to copy. Select Download.

To copy multiple files to your smartphone in one go tap . Select which files to copy, or tap  to select all files. Select Download.

Managing videos in INTERNAL MEMORY

Open the BlackVue app and select INTERNAL MEMORY.

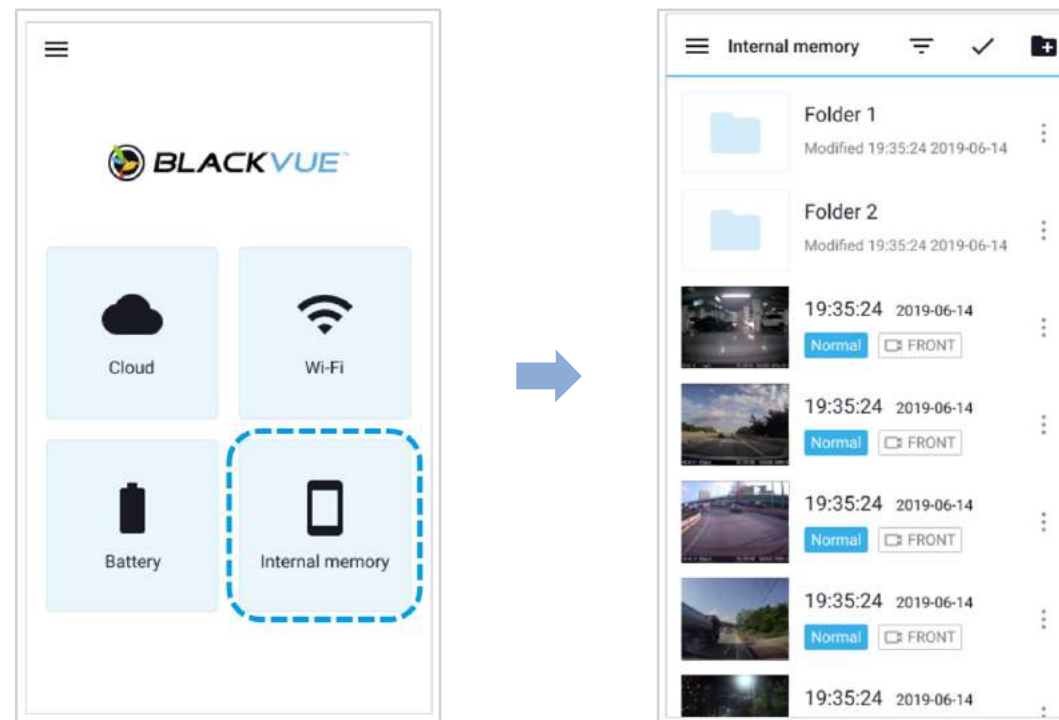

Tap  to see file options. You can delete, copy or move files, change the name of files.

■ Deleting videos

To delete multiple files from your smartphone in one go, tap ✓ and select **Delete**. Select which files to delete, or tap ✓✓ to select all files. Tap 🗑️ to delete the selected files.

To delete individual files, tap ⋮ next to the video you want to delete. Select **Delete**.

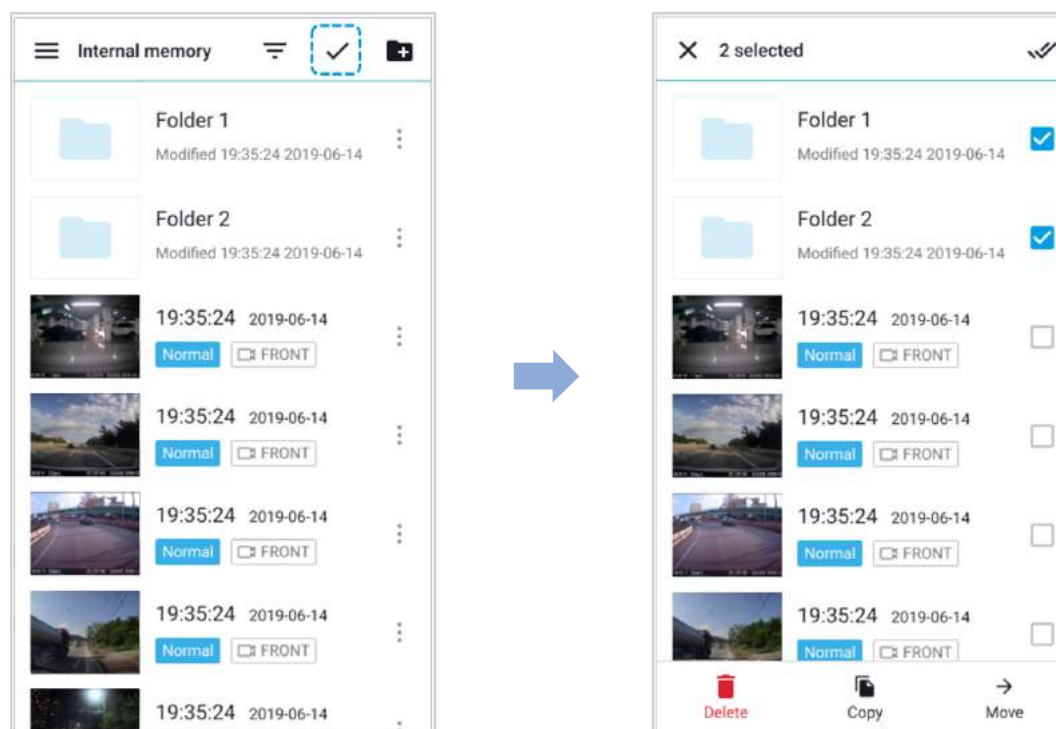

■ Creating a new folder

To create a new folder, tap . Enter a new folder name and press Add.

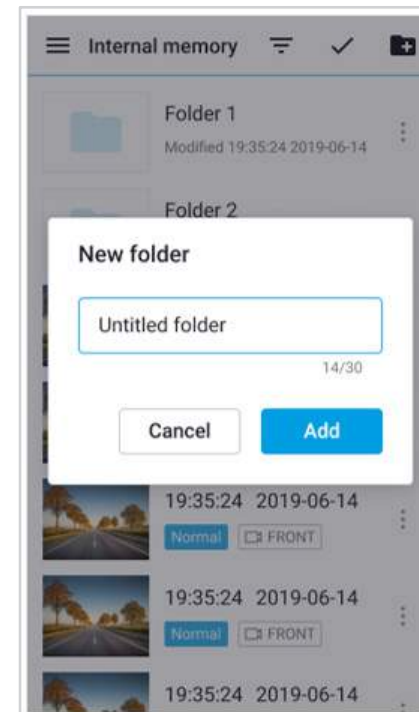
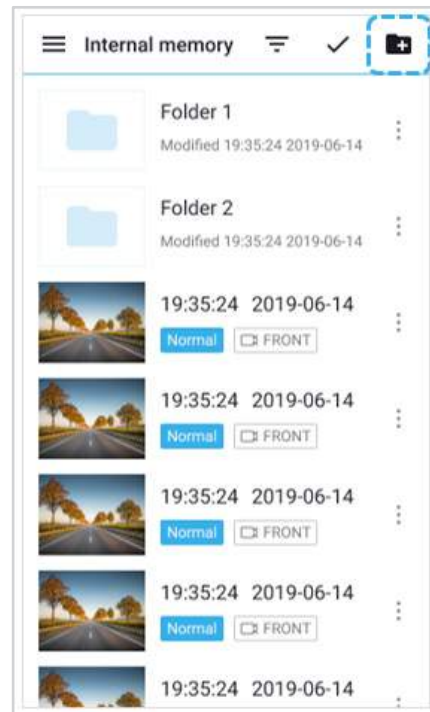

■ Deleting a folder

To delete a folder, tap  and select **Delete**.

■ Copying and pasting videos

To copy multiple files in one go, tap  and select **Copy**. Select which files to copy, or tap  to select all files.

Tap  to copy the selected files. Go to another folder and tap  to paste the selected files there.

To copy individual files, tap  next to the video you want to copy. Select **Copy**. Go to another folder and tap  to paste the file there.

■ Moving videos

To move multiple files in one go, tap ✓ at the top of the screen. Select which files to move, or tap ✓✓ to select all files.

Tap → and go to another folder and tap  to move the selected files there.

To move individual files, tap ⋮ next to the video you want to move. Select **Move**. Go to another folder and tap to move the file there.

■ Renaming a video

To rename a video, tap ⋮ next to the video you want to rename. Select **Change name**. Enter a new name and tap **OK**.

▶ Playing and managing video files using your computer (Windows/macOS)

➤ Removing the microSD card

- 1 Unplug the power cord to turn off the dashcam.
- 2 Open the cover of the microSD card slot.
- 3 To remove the microSD card, gently press on the card to release the lock then carefully pull the card out.
To insert the microSD card, gently push the card into the slot until it locks into place and close the cover.

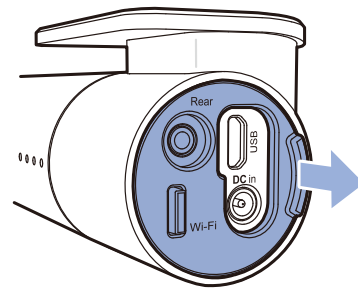

Open side cover

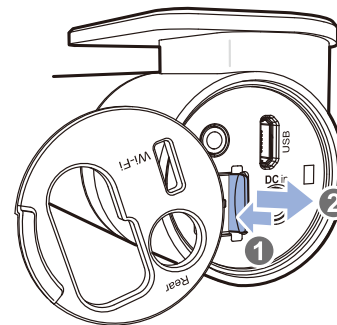

To remove

➤ Opening video files in BlackVue Viewer

- 1 Remove the microSD card from the dashcam.
- 2 Insert the card into the microSD card reader and connect it to a computer.

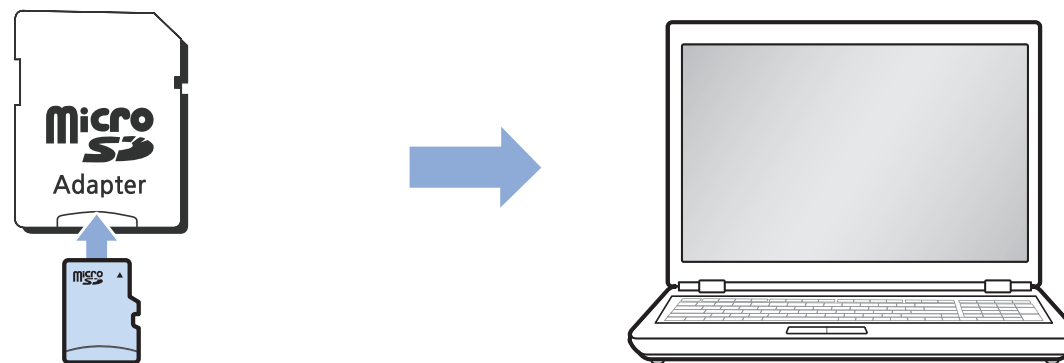

- 3 Download BlackVue Viewer from www.blackvue.com > **Support** > **Downloads** and install it on your computer.
- 4 Run BlackVue Viewer.
- 5 To play, select a video and click on the play button or double click the selected video.

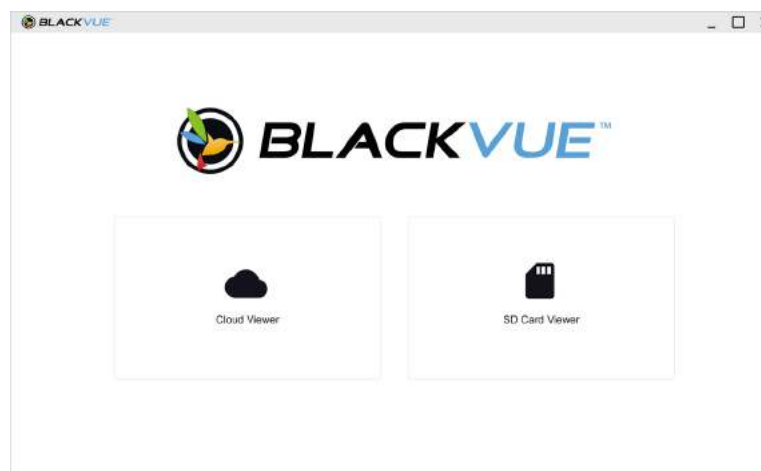

Select SD card viewer in the launcher page.

Viewer screen composition (Windows/macOS)

When you execute the program, a launcher window will be shown. You can choose either SD card Viewer or Cloud Viewer. To go back to the launcher screen, click the  button.

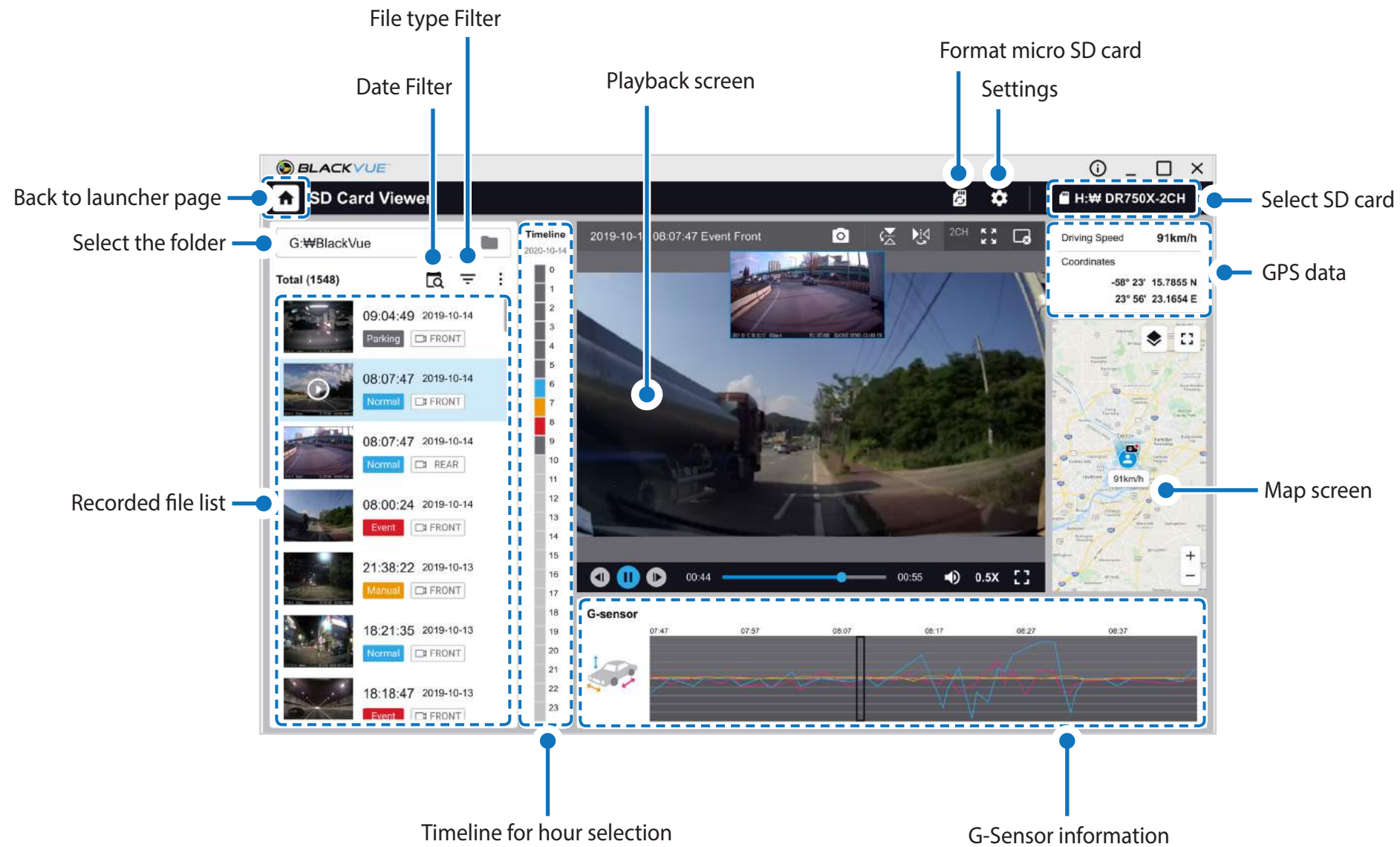

Note

- All images shown are for illustration purpose only. Actual app may differ from images shown.



Playing video

Playing back videos

In BlackVue Viewer double click a video file to play.

BlackVue Viewer shows by default the files in the microSD card. To see files in another folder click the  button and browse to the folder.

Identify video files by recording type

	Normal	The dashcam records in normal mode by default.
	Event	When the dashcam detects an impact while in normal or parking mode, it switches to event mode and saves an event recording beginning 5 seconds before the event trigger. Exceeding the set speed limit will also trigger an event recording.
	Parking	In parking mode the dashcam continuously buffers video. When motion is detected in the dashcam's field of view, it saves a parking recording beginning 5 seconds before the motion detection.

Note

- The dashcam requires a constant power source to record in parking mode. See "**Optional accessories**" on page 88 for more information.

Checking the displayed time

The time the video was recorded is displayed in the lower left corner of the video in the playback screen. If the displayed time in the recorded videos is incorrect please see "**Time settings**" on page 51 or 71.

Using BlackVue Viewer

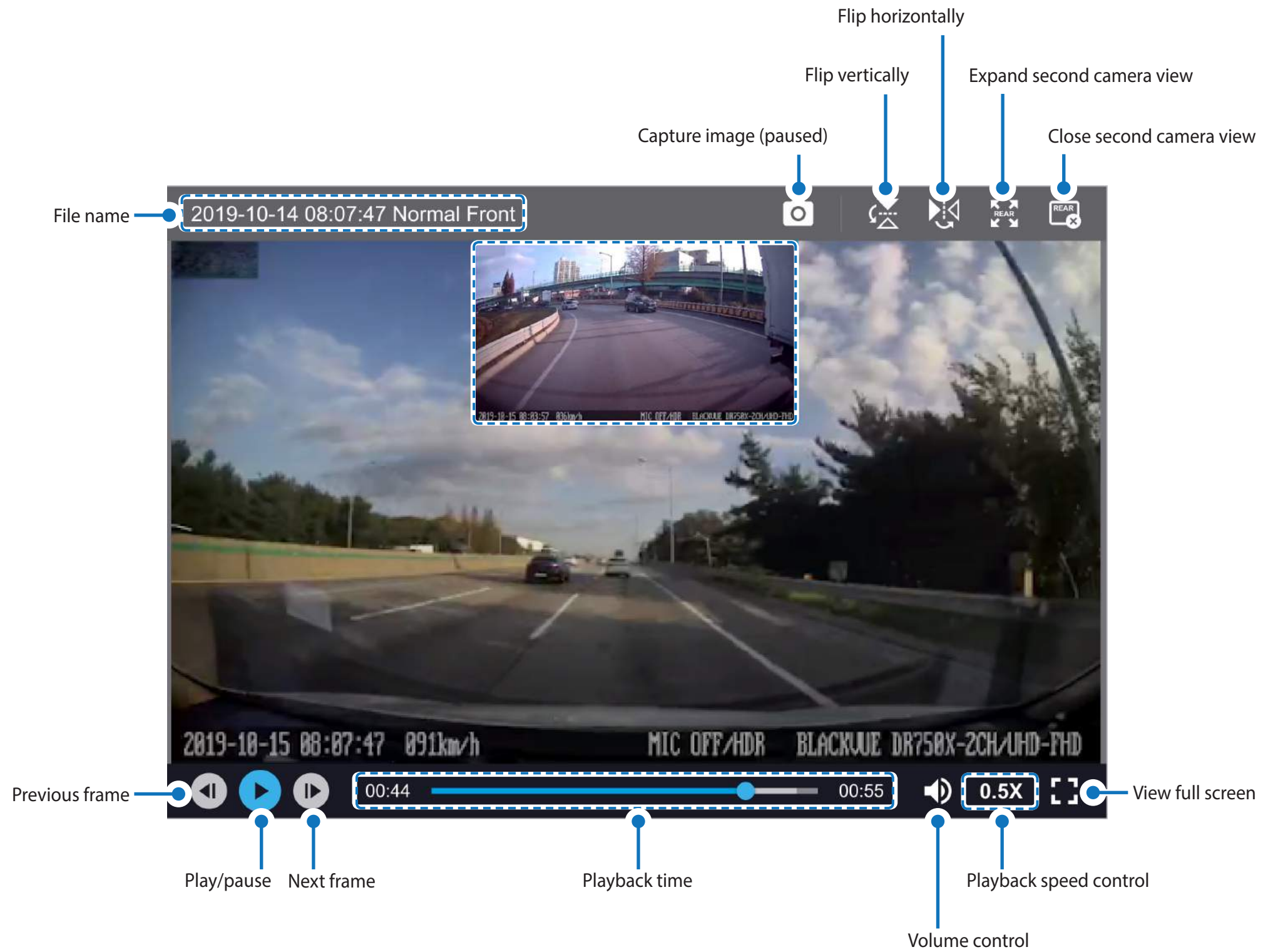

Exploring the timeline and G-Sensor graph

You can check the impact sensitivity (G-Sensor) information in the line graph.

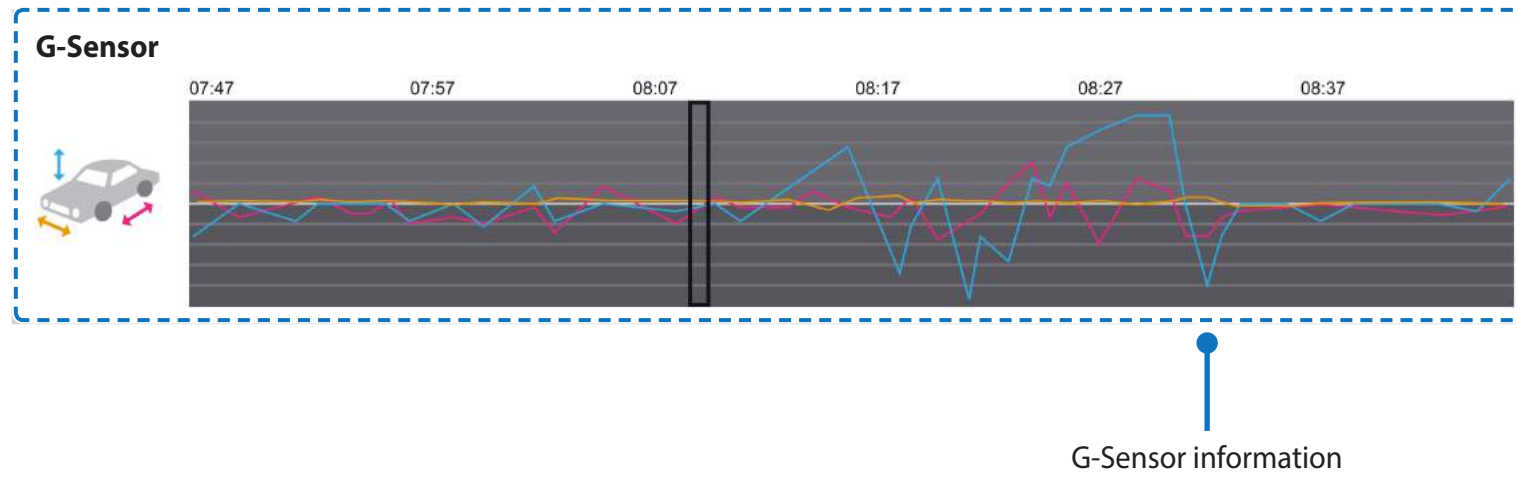

Zoom options

- Use the mouse scroll wheel zoom. Right clicking will restore the video to the default size.
- You can resize the playback frame or the BlackVue Viewer window by dragging the borders.
- **Full-screen view:** Double click on the video image to enter full-screen view. Double click again or tap ESC to return to the default view.

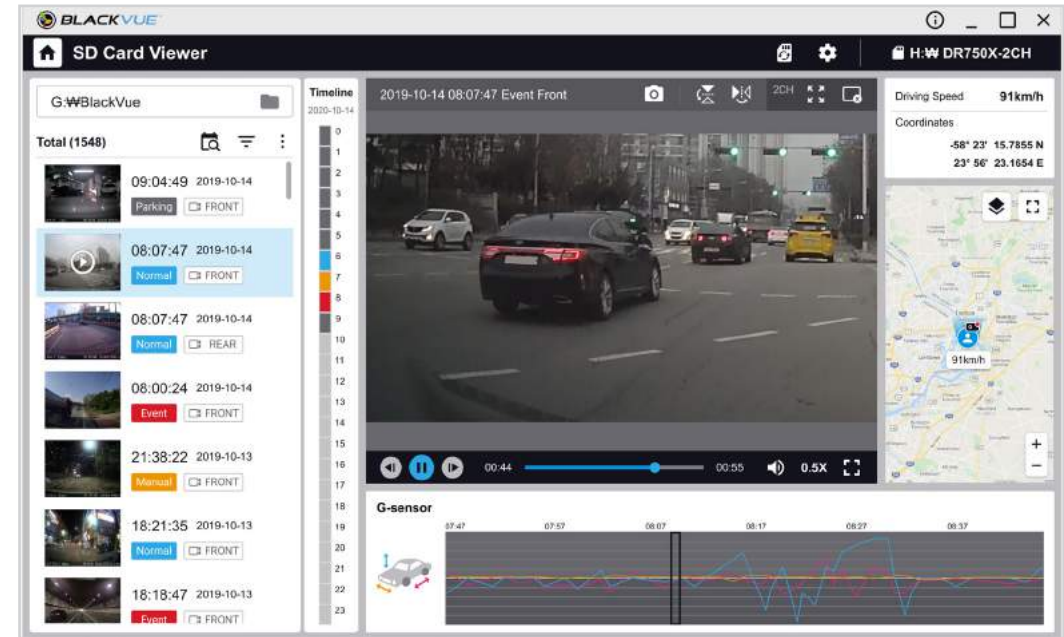
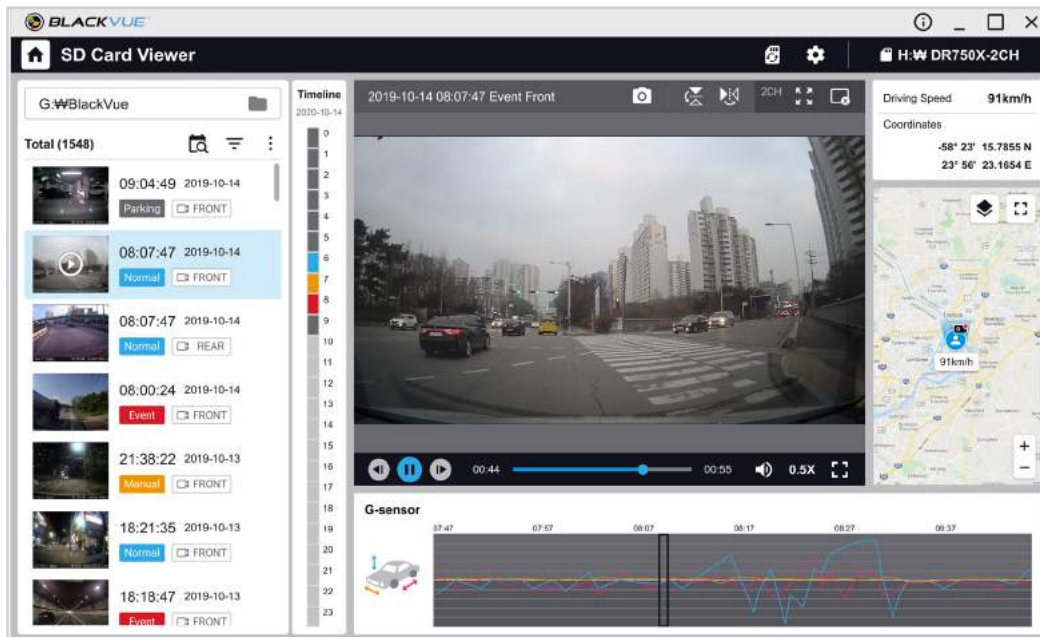

☐ Checking the GPS data

You can check the GPS data of the recorded video in BlackVue Viewer while video is playing back. The driving speed and coordinates are displayed above the map frame.

📝 Note

- GPS data is not recorded during parking mode. Map data cannot be displayed for parking mode recordings.

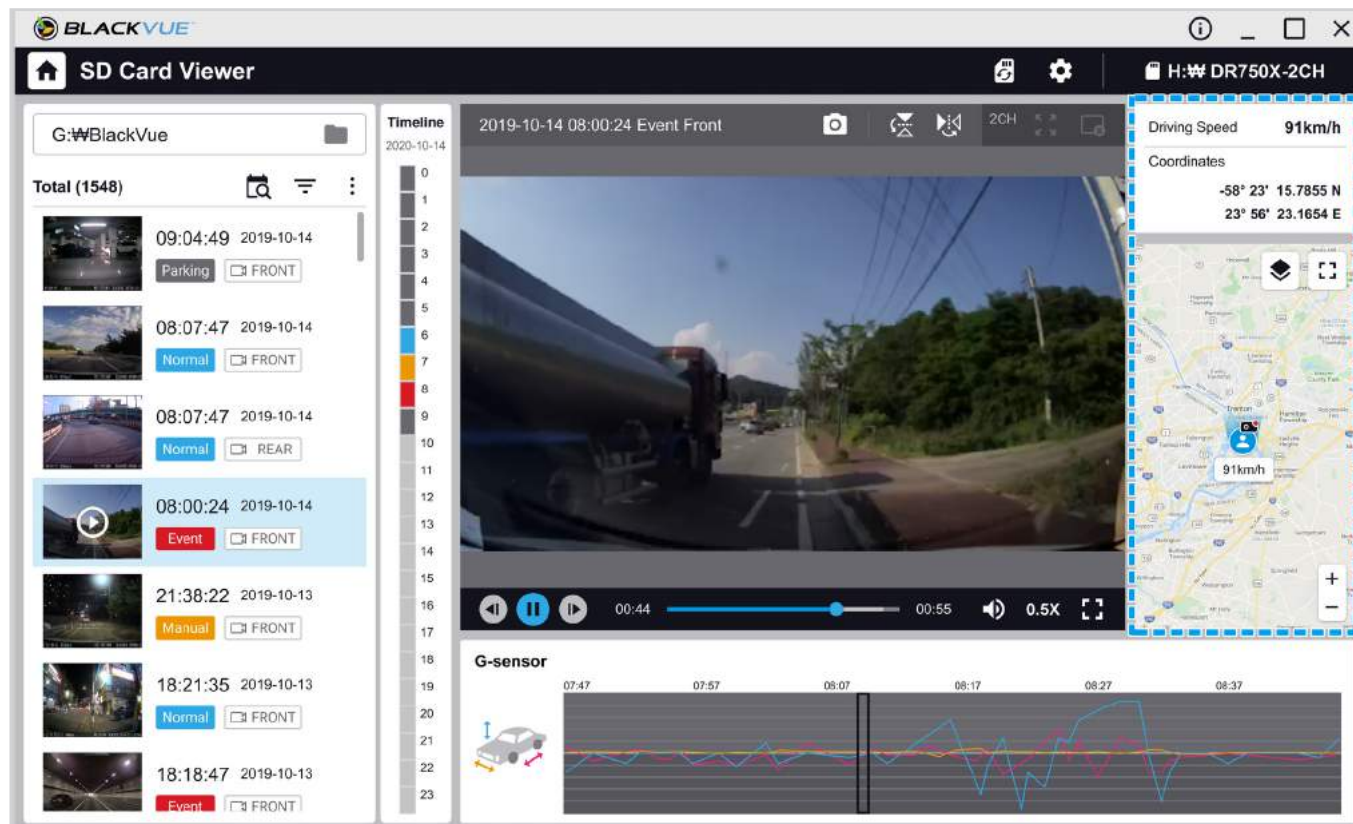



Managing videos

You can manage the recorded videos through the BlackVue Viewer program. You can also format the microSD card.

Note

- If the microSD card is full, by default the dashcam will record over the oldest videos first.

Capturing or printing a still image from video

- 1 Double click a file in the file list to play.
- 2 Click the  pause button to pause the video.
- 3 Select the  capture button to capture the image.

Deleting videos

- 1 Move the cursor on a video you want to delete and right-click the mouse button.
- 2 Click **Delete**.
 - You can also delete individual files by clicking  next to a video in the recorded video list and selecting **Delete**.

□ Exporting videos

1 Point a mouse at a video you want to export and Click the right mouse button.

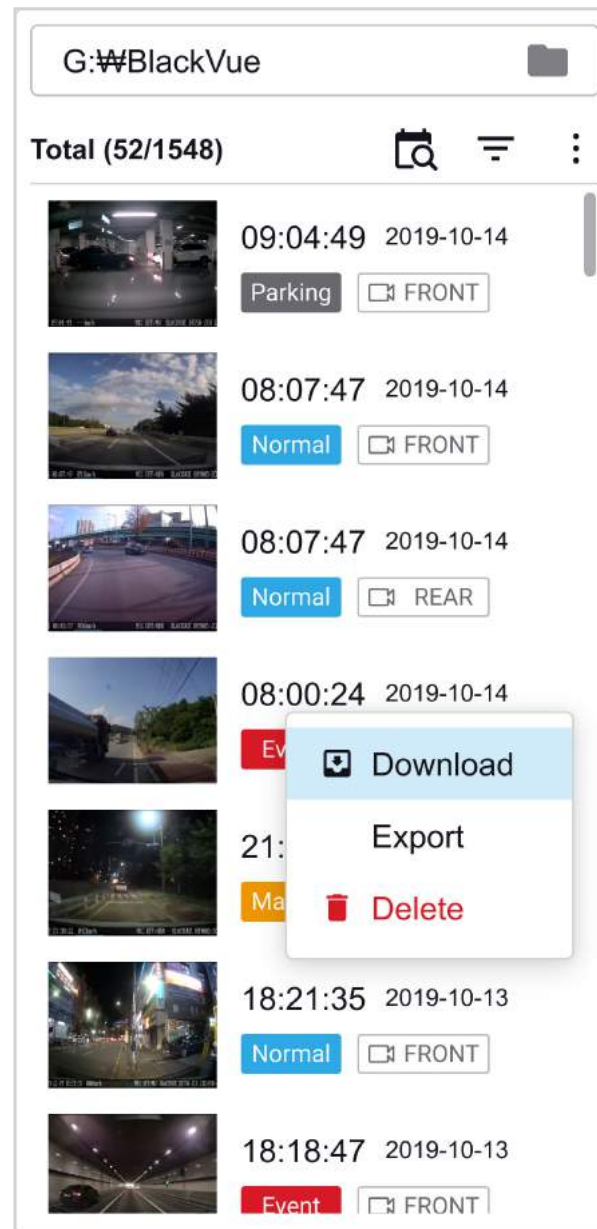

2 Click **Export**.

- 3 If you want to extract a segment of a file, edit the start and end second points from **Select segment**. To export without audio select **Sound Off**.

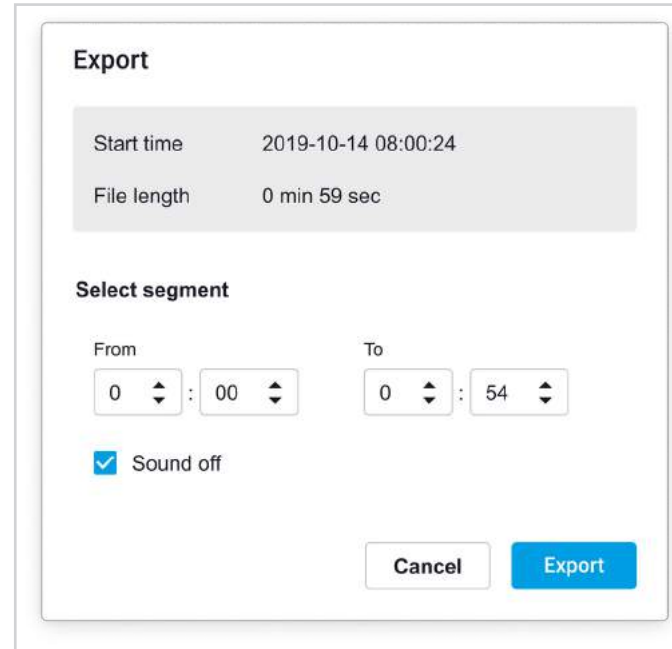

Export

Start time 2019-10-14 08:00:24
File length 0 min 59 sec

Select segment

From 0 : 00 To 0 : 54

Sound off

Cancel Export

- 4 Click the **OK** button.
- 5 Select the folder in which to save the file and enter the file name.
- 6 Click the **Save** button.

Copying videos

- 1 Point a mouse at a video you want to download and Click the right mouse button.
- 2 Click **Download**.
- 3 Select the folder in which to copy the file and enter the file name.
- 4 Click the **Select folder** button.
 - To copy multiple files at once check the boxes next to the file names and press the **Download** button.
 - When copying files the segment adjustment and sound off tools are not available.

Formatting the microSD card

Caution

- Back up necessary video files before formatting the microSD card. If you format the microSD card, all the video files stored in the microSD card will be deleted including the locked event files. Your saved settings will not be affected.

Format using BlackVue Viewer (Windows)

- 1** Insert the microSD card into the microSD card reader and connect the reader to your computer.
- 2** Download **BlackVue Viewer (Windows)** from www.blackvue.com > **Support** > **Downloads** and install it on your computer.
- 3** Launch the **BlackVue Viewer** that is installed on your computer.
- 4** Click the  Format button, select the card drive and click OK.

➤ Format using BlackVue Viewer (macOS)

- 1 Insert the microSD card into the microSD card reader and connect the reader to your computer.
- 2 Download **BlackVue Viewer (Mac)** from www.blackvue.com > **Support** > **Downloads** and install it on your computer.
- 3 Launch the **BlackVue Viewer** that is installed on your computer.
- 4 Click the  Format button and select the microSD card from the list of drives in the left frame.

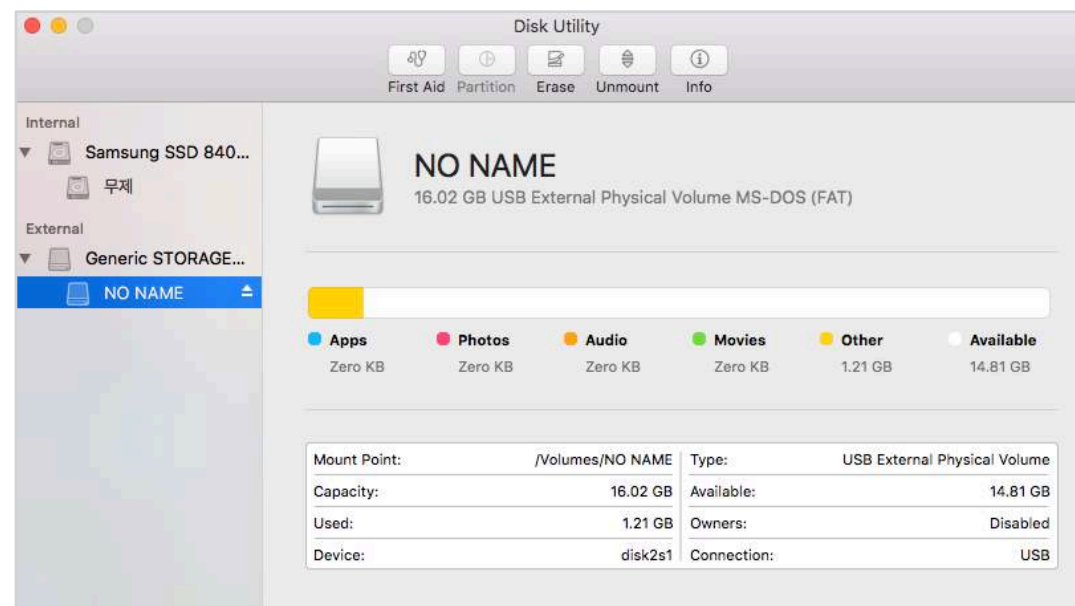

- 5 After selecting your microSD card select the Erase tab in the main window.

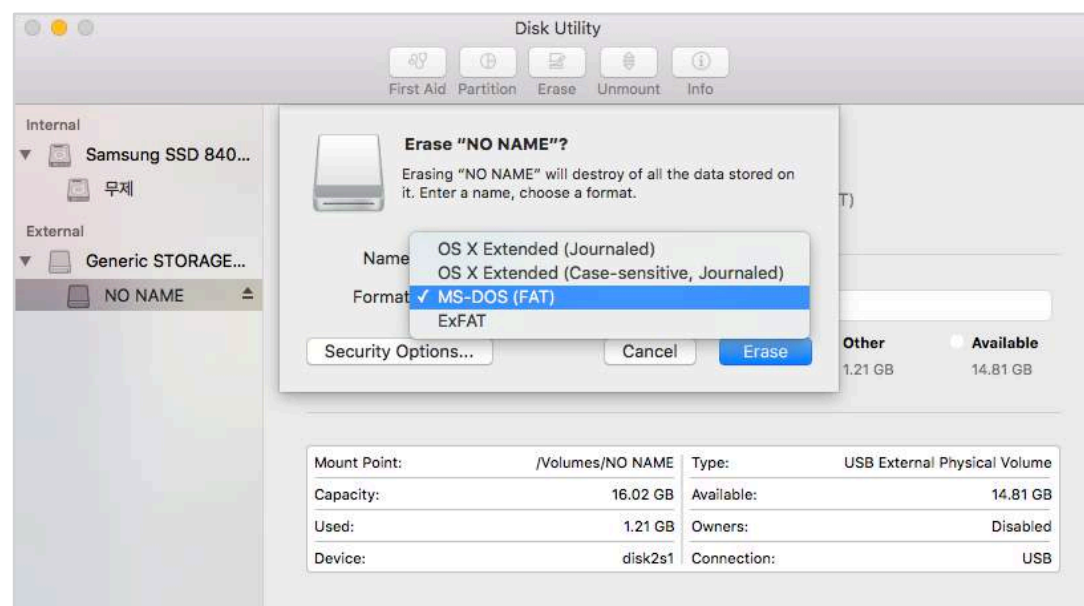

- 6 Select "MS-DOS (FAT)" from the Volume Format drop-down menu and click Erase.

Note

- Formatting the microSD card once a month is recommended.
- Format the microSD card if the recorded video quality appears to be poor.
- Only use official BlackVue microSD cards. Other cards may have compatibility issues. PittaSoft Co., Ltd. will not be held responsible for any problems caused by using another manufacturer's microSD card.
- For Windows users: To format the microSD card directly from "My Computer", right-click the microSD card drive and select Format. Select File system as FAT32 and Allocation unit size as 64KB then click Start. If FAT32 is not available or can't be selected, please format the microSD card using BlackVue Viewer.

Upgrading the firmware

Regularly upgrade the firmware for performance improvements and updated features. Firmware updates will be made available for download at www.blackvue.com > **Support** > **Downloads**.

Your saved settings are not affected by firmware upgrade.

Upgrading the firmware using an iOS or Android device (Firmware Over The Air)

[Click here for a step-by-step video tutorial](#), or go to the main menu and select **Help** > **Video tutorials**.

Makes sure your smartphone has a stable internet connection.

- 1** Open the BlackVue app
- 2** Tap  and select **Firmware download**.
- 3** Select your dashcam model and the firmware language and tap **OK**.

Note

- Please select the firmware language currently installed in your dashcam. Once upgrade is completed, you can change the firmware language from dashcam settings as described on page **67** or **70**.

- 4** Check the firmware version and release notes and tap **OK** to start downloading.
- 5** After the download completes tap **OK** to be taken back to the home screen.
Make sure your BlackVue dashcam is on and nearby.

6 Go to your smartphone's **Settings** then select **Wi-Fi**, and make sure Wi-Fi is turned on.

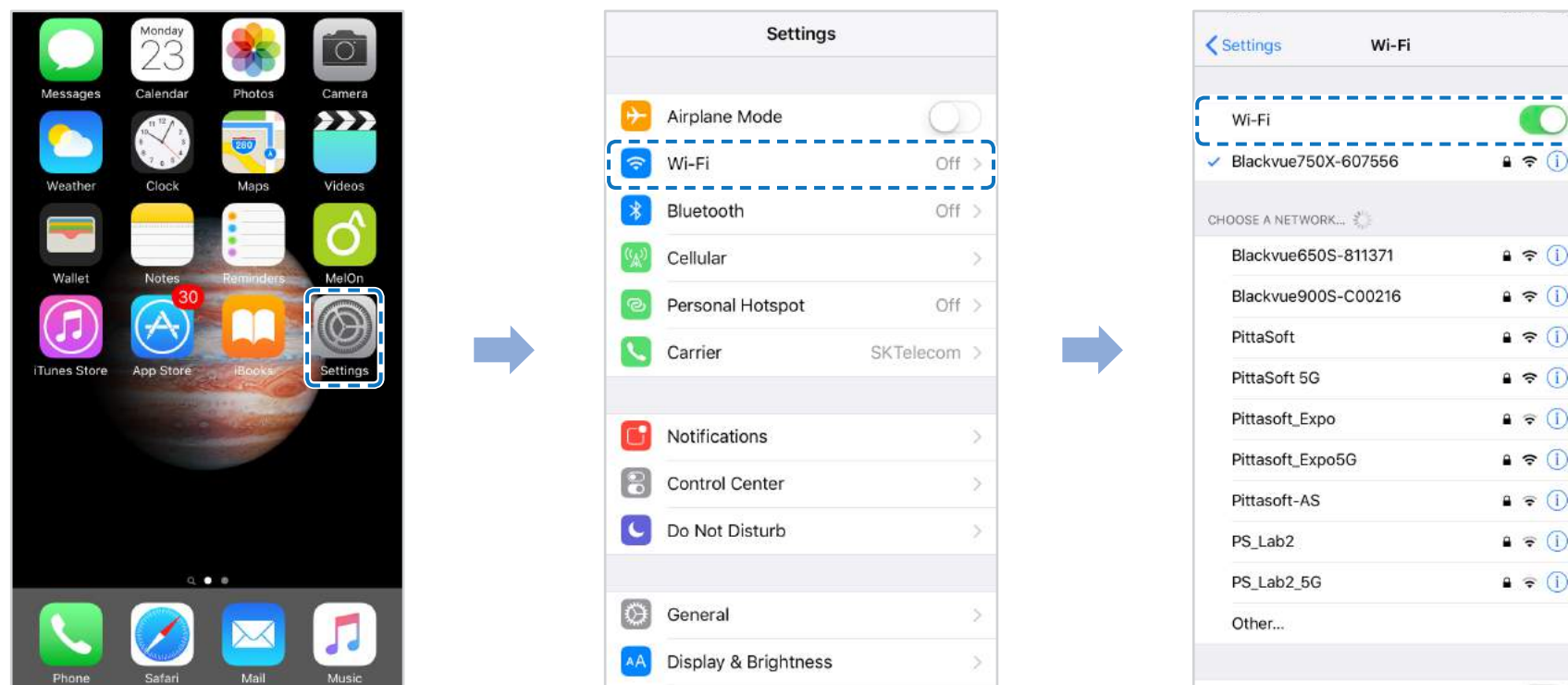

7 Choose your BlackVue dashcam from the network list. The dashcam's default SSID begins with its model number (e.g. BlackVue590X-*****).

8 Enter the password and tap join.

* The default Wi-Fi SSID and password is labeled on the dashcam. To find them, unplug the cables and remove the front camera from its mount.

9 Open the BlackVue app. Select **WI-FI** > **⚙️** > **Firmware upgrade**.

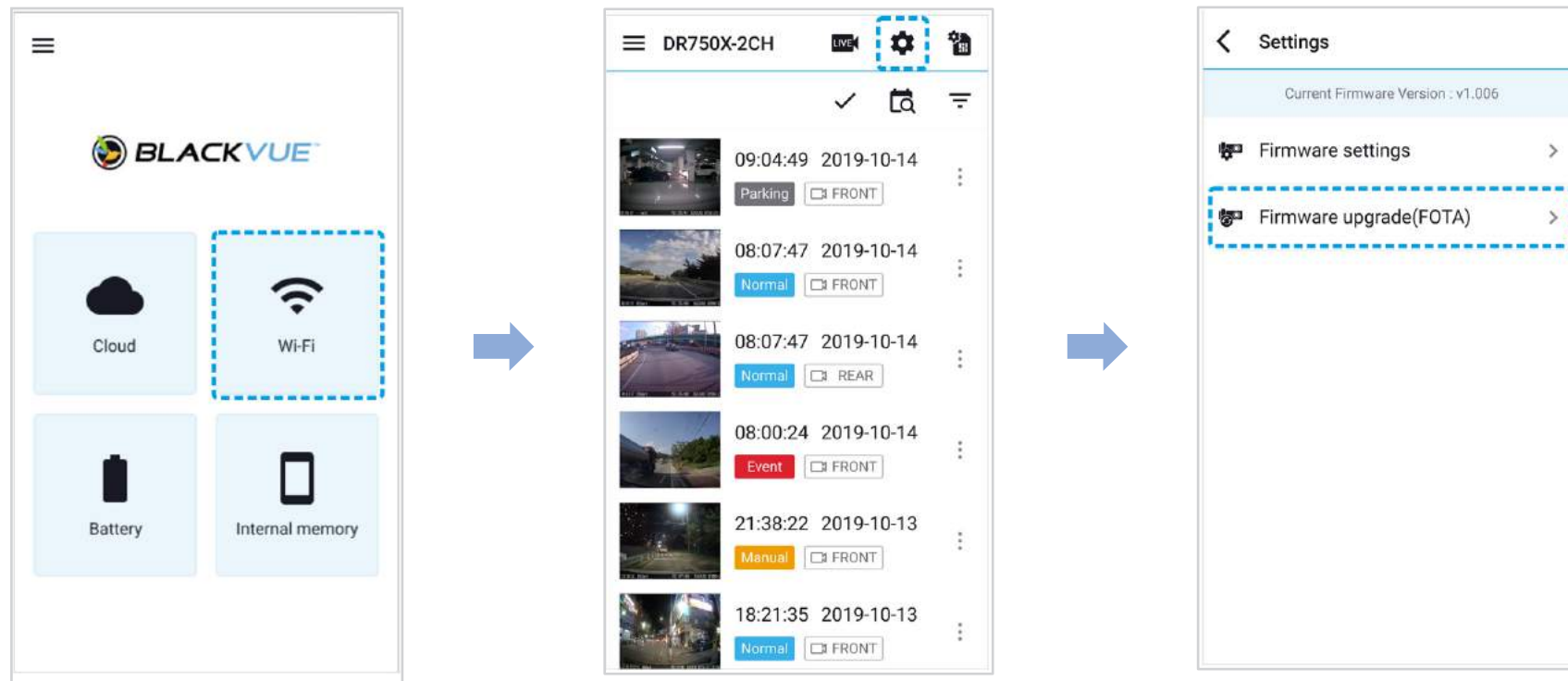

Note

- The firmware version currently installed on the microSD card is shown first. Below it, the firmware version you downloaded in step 4 is shown.

10 Tap **OK** to apply the firmware upgrade.

11 The dashcam's firmware will be upgraded – this may take a few minutes. The dashcam needs to reboot to complete the firmware upgrade.

Caution

Please make sure the dashcam is powered on until normal recording starts after the upgrade is completed. Any power interruption may prevent the firmware upgrade from completing, resulting in malfunction of the dashcam.

➤ Upgrading the firmware using a computer (Windows/macOS)

Keep your BlackVue dashcam updated by upgrading the firmware to the latest version. Visit the BlackVue website (www.blackvue.com) to check for any new firmware releases for your BlackVue dashcam model.

- 1 Insert the microSD card into the microSD card reader.
- 2 Connect the microSD card reader to a computer.
- 3 Launch BlackVue Viewer > Select SD card Viewer and click on the About ⓘ button.
 - For Mac users, click  **BlackVue Viewer** and select About BlackVue from the menu.
- 4 Check the current firmware version of your BlackVue dashcam and proceed only if your version is not the latest one.

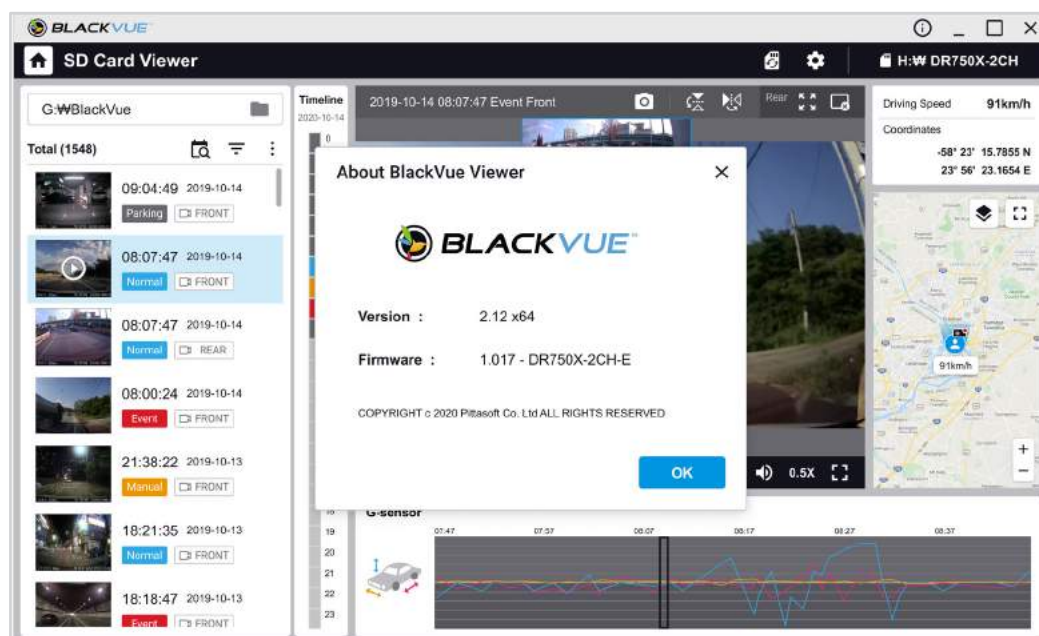

Windows

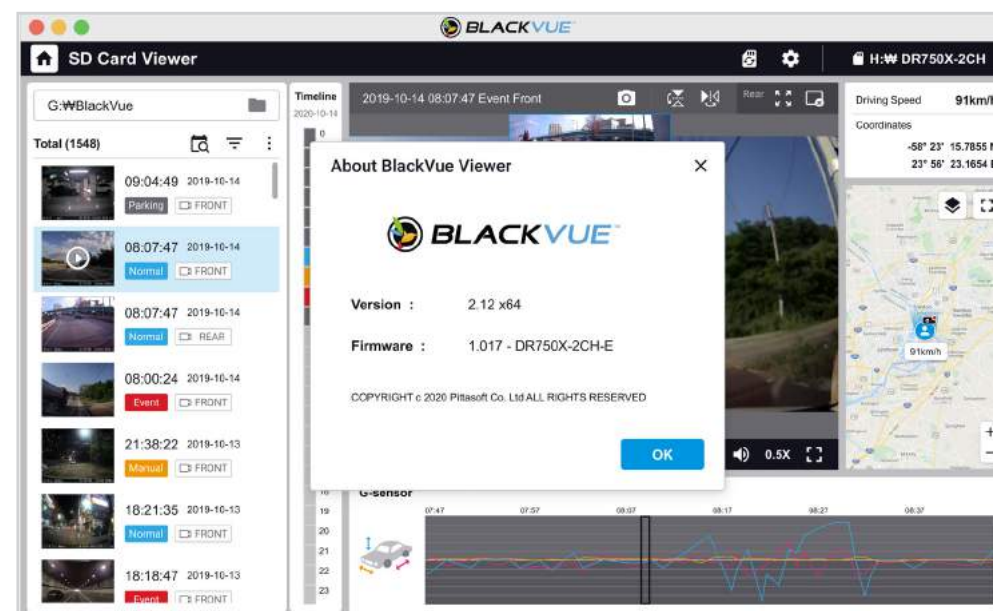

Mac

- 5 Format the microSD card. See **"Formatting the microSD card"** on page 41.
- 6 Go to the BlackVue website (www.blackvue.com > Support > Download) and download the latest firmware for your BlackVue dashcam model in zip format.

7 Unzip the downloaded file and copy the BlackVue folder to the microSD card.

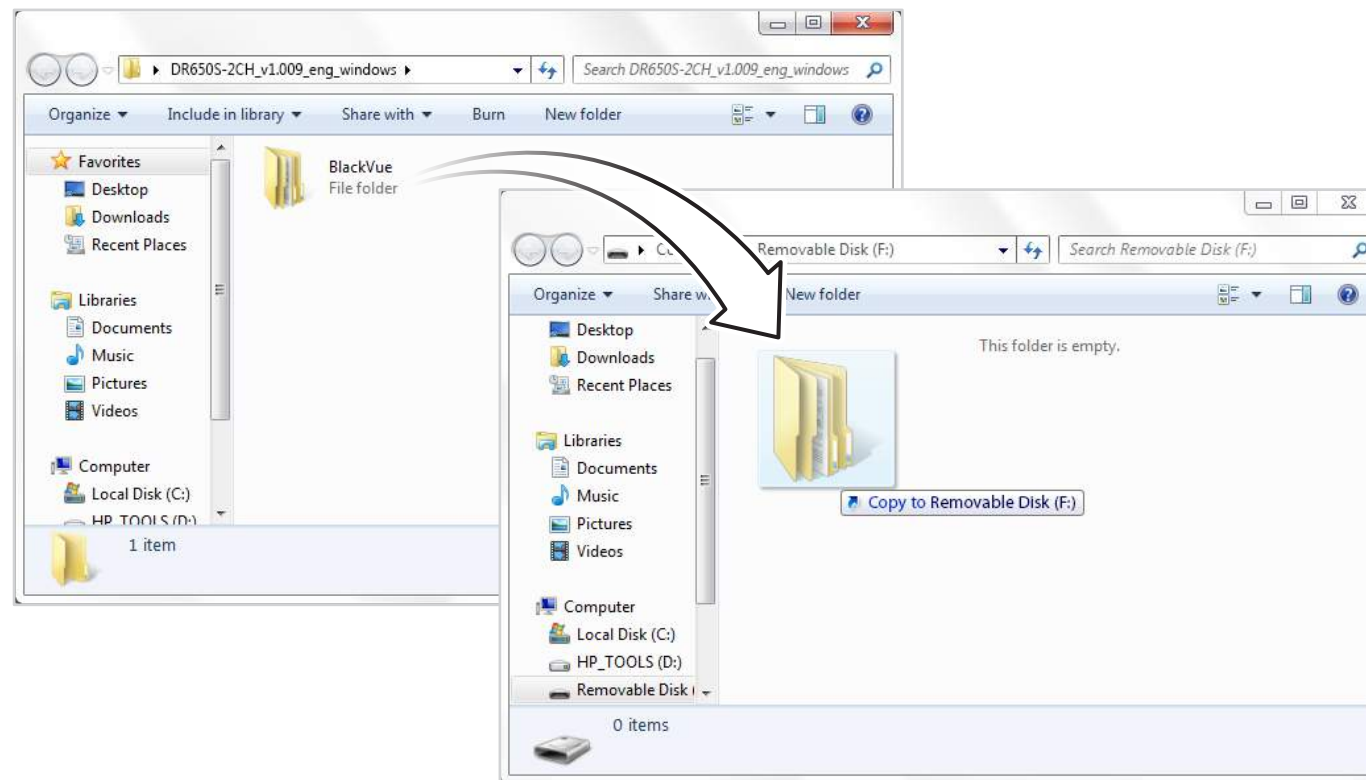

8 Insert the microSD card into the dashcam and connect the power to initiate the firmware upgrade. Make sure the power remains on until the upgrade is completed. Any power interruption may prevent the firmware upgrade from completing, resulting in malfunction.

Note

- Do not insert or remove the microSD card when the dashcam is turned on. Doing so may damage the data and cause a malfunction of the microSD card.
- Your saved settings are not affected by firmware upgrade.
- The firmware is upgraded to the previously saved language. If you want to change it, please refer to page **67** or **70**.

▶ Changing settings using your smartphone (Android/iOS)

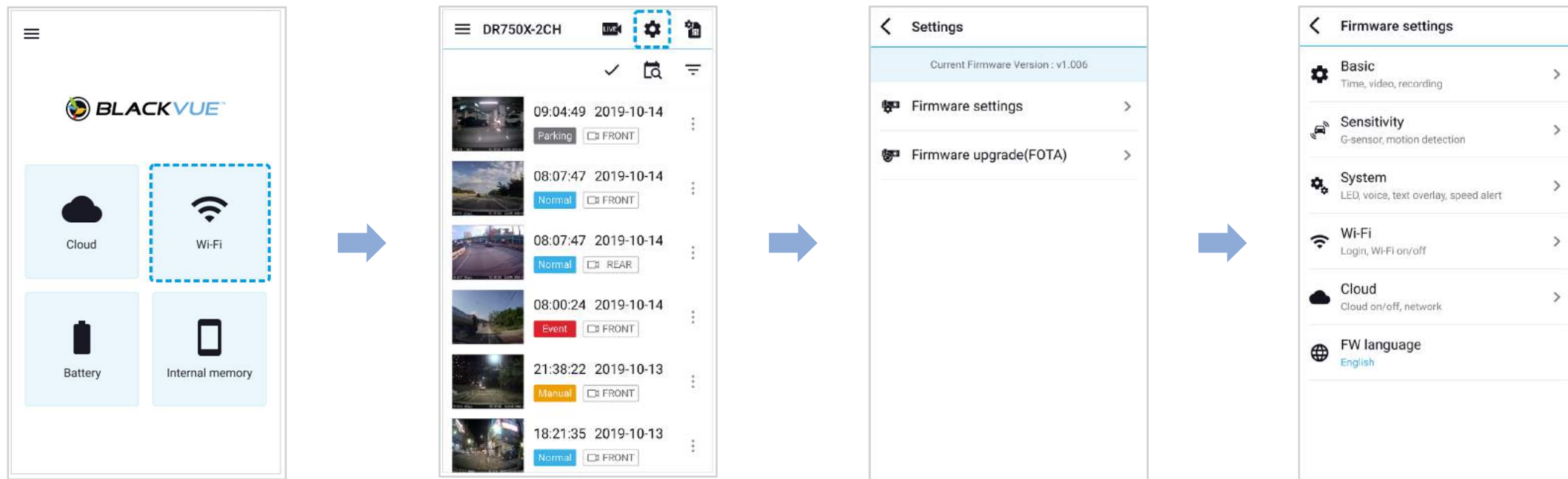

“Pair” your smartphone with the BlackVue dashcam via Wi-Fi direct (for details see **"Opening video files" on page 19**).

- 1 Go to your smartphone's **Settings** > **Wi-Fi** and connect to your dashcam.
- 2 Open the BlackVue app. Select **WI-FI** > **⚙️** to access the Firmware settings menu.
- 3 After making any changes, go back to the Firmware settings menu, tap **<** and tap **Save**.

⚠️ Caution

- Please backup necessary recordings before changing **time** or **image quality** settings. If any of the aforementioned settings are changed and saved, the dashcam will format the microSD card and delete all recordings stored on the card including locked event files in order to ensure optimal performance.

Basic settings

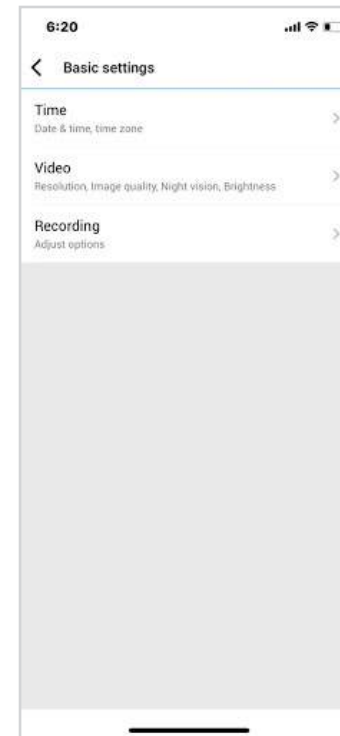
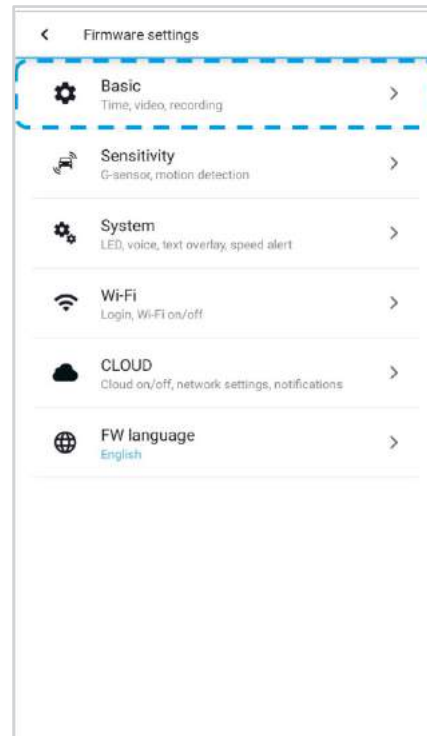

Time settings

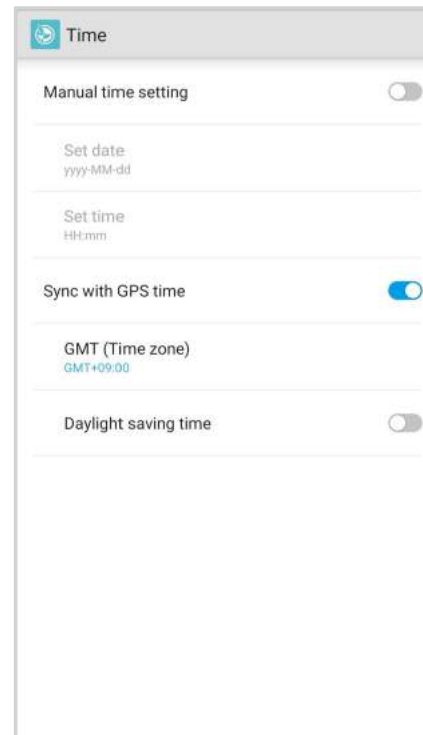

Select your time zone to auto-sync with GPS time or you can set the time and date manually after enabling **Manual time setting**.

 **Note**

- The factory setting is GMT -11.

Some examples of GMT time offsets are:

- GMT-7: Los Angeles
- GMT-4: New York
- GMT+0: London
- GMT+1: Paris
- GMT+3: Moscow
- GMT+8: Singapore
- GMT+9: Seoul
- GMT+10: Sydney

If you are unsure of your GMT offset please look up your city on <https://greenwichmeantime.com/>

* Selecting **Daylight saving time** will advance the clock by one hour.

- When setting the time manually, please set to the expected time you will use the BlackVue (not the present time).

Video settings

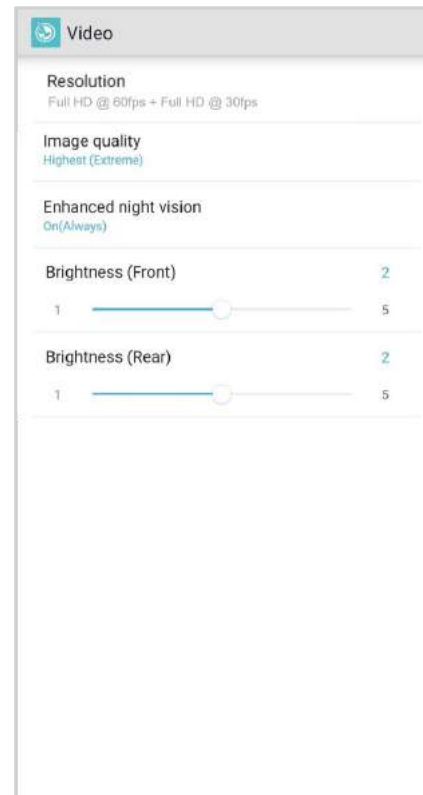

Resolution

Resolution and frame rate is fixed at "FHD@30 + FHD@30". This means the front camera records Full HD video at 30 frames per second, and the rear camera records Full HD video at 30 frames per second.

Note

* Frame rate may vary during Wi-Fi streaming.

■ **Image quality**

You can adjust the recording image quality (bit rate) settings. Choose between:

- Highest (Front: 12 Mbit/s, Rear: 10 Mbit/s)
- High (Front: 10 Mbit/s, Rear: 8 Mbit/s)
- Normal (Front: 8 Mbit/s, Rear: 6 Mbit/s)

Increasing the image quality will increase the size of the video files. Loading and copying time will increase accordingly.

■ **Enhanced night vision**

The dashcam has intrinsic night vision feature. If you want to enhance it, enable Enhanced night vision.

■ **Brightness (Front)**

You can adjust the recording brightness level of the front camera.

■ **Brightness (Rear)**

You can adjust the recording brightness level of the rear camera.

Recording settings

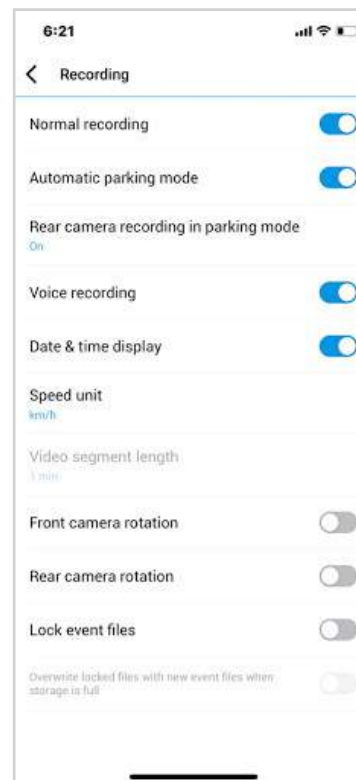

Normal recording

When turned off the dashcam does not record in normal mode.

Parking mode recording

If enabled, the dashcam switches from normal mode to parking mode when the vehicle is turned off (ACC+) or stationary for 5 minutes (G-Sensor). There are two parking mode options. Choose "Motion & Impact detection" to save a parking recording when motion is detected in the dashcam's field of view. If the G-sensor detects an impact/bump the dashcam saves a separate event recording file.

■ **Rear camera recording in parking mode**

When turned on, the front and rear camera record together.

When turned off, the rear camera stops recording 5 minutes after entering parking mode. Rear camera recording restarts when entering normal mode.

■ **Voice recording**

When turned off the dashcam does not record audio.

■ **Date & time display**

Turn on/off the date and time display on videos.

■ **Speed unit**

Select km/h, MPH, or turn off.

■ **Video segment length**

Video segment length is fixed at 1 minute.

■ **Lock event files**

Turning on this option will lock the following recording types and stop them from being overwritten by newer recordings:

- Impact event recordings during normal and parking mode (E)

A maximum of 50 files can be locked. Once this limit is reached, to lock new recordings please review locked files on the microSD card and free up space, or enable 'Overwrite locked files with new event files when storage is full' to allow the oldest locked files to be overwritten.

- **Front camera rotation**

If you installed the front camera in a flipped position, use this setting to rotate the front camera image 180°.

- **Rear camera orientation**

Use this setting to rotate the rear camera image 180° or mirror the video.

Sensitivity settings

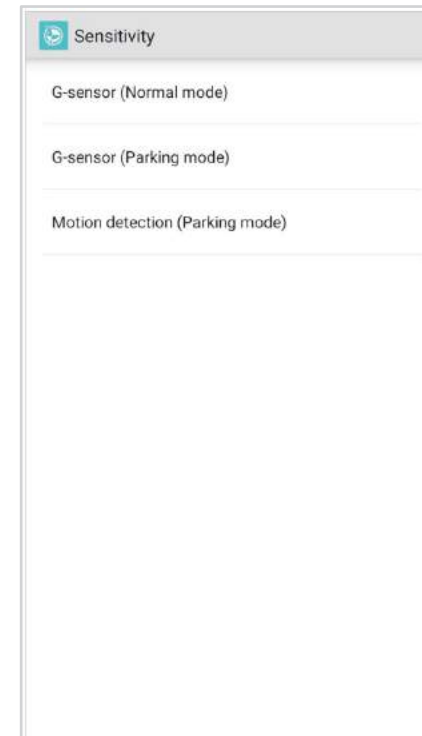
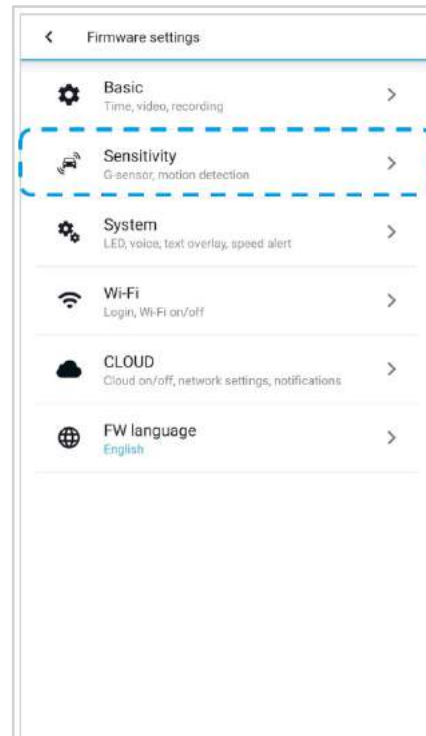

□ G-Sensor (Normal mode) / G-Sensor (Parking mode)

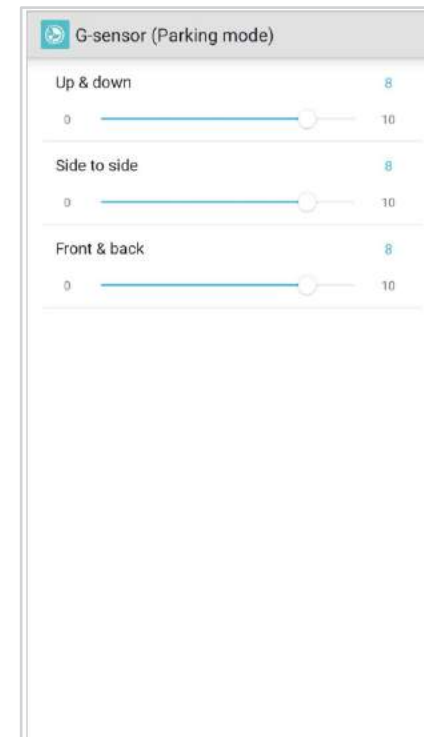
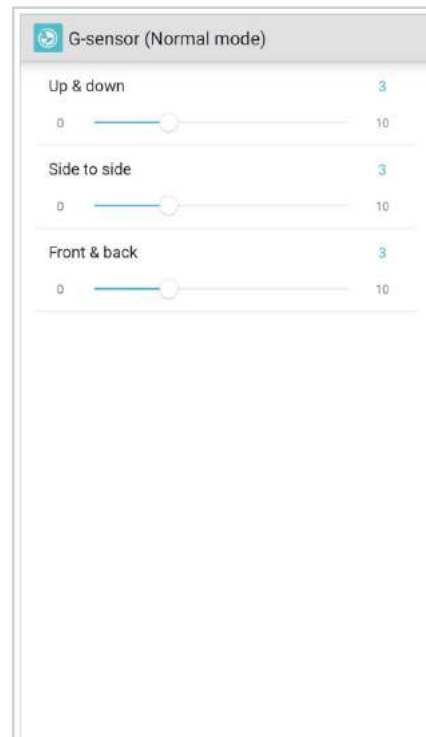

The G-sensor measures the movement of your vehicle through 3 axes – up and down, side to side, and front and back. When the G-sensor detects significant or sudden movement (such as an impact or collision) it will trigger an event recording. You can adjust the sensitivity so minor incidents and bumps don't trigger an event recording. To turn off event recordings by impact detection set the G-sensor sensitivity to off.

Motion detection (Parking mode)

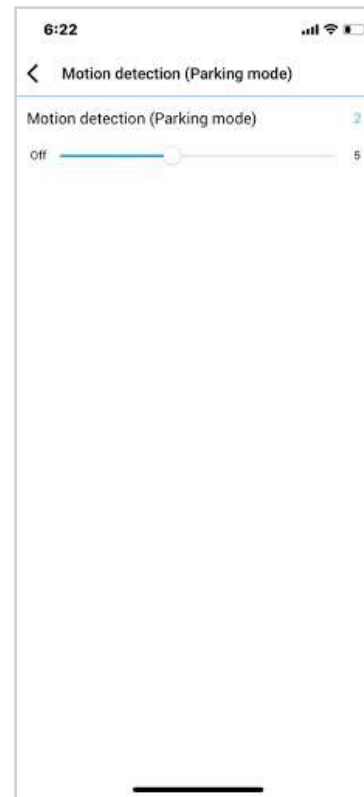

In Motion Detection Parking Mode the dashcam continuously buffers video and saves a parking recording when motion is detected in the dashcam's field of view.

➤ System settings

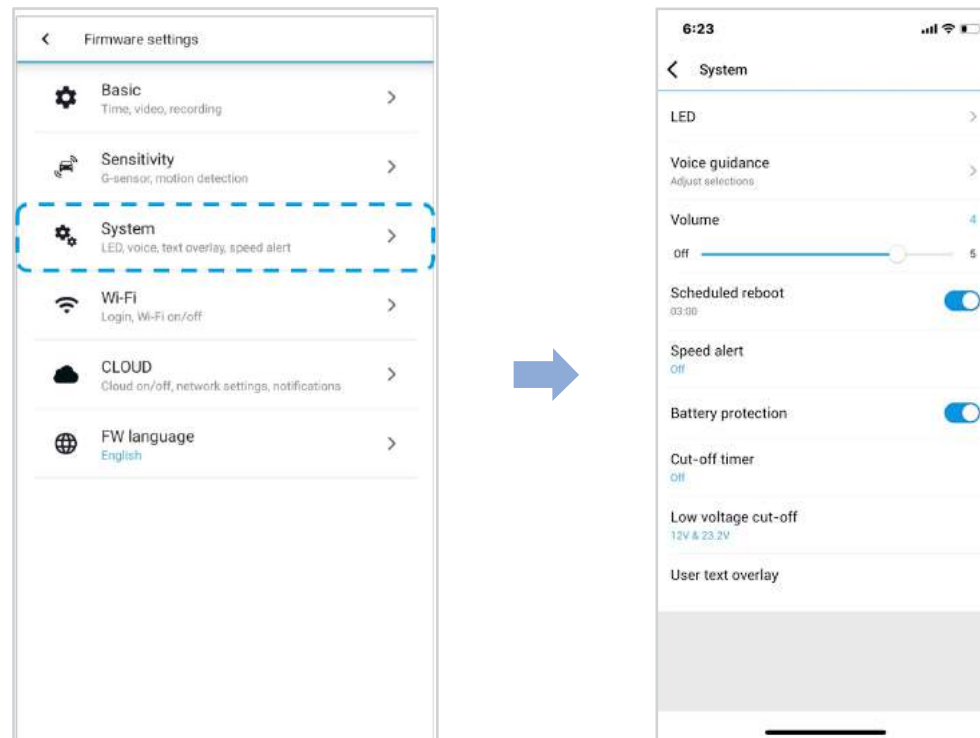

LED

Recording status

You can turn the recording status LED on/off.

Front security (Normal mode)

You can turn the front security LED on/off for normal mode.

Front security (Parking mode)

You can turn the front security LED on/off for parking mode.

Rear security

You can turn the rear security LED on/off.

LTE (Parking mode)

You can turn the LTE LED on/off for parking mode.

Wi-Fi (Parking mode)

You can turn the Wi-Fi LED on/off for parking mode.

Voice guidance

Impact detected in parking mode

Notifies when exiting parking mode if an impact had been detected during parking mode, however, it ignores any impact detected within three minutes before exiting parking mode.

Volume

You can adjust the volume of the voice guidance (announcements).

Scheduled Reboot

The dashcam reboots automatically once-a-day if in parking mode at the set time for improved stability. If the dashcam is recording at the set time, the scheduled reboot is skipped.

You can enable/disable and change the time for scheduled rebooting. Default time is 03:00 am.

Speed alert

Set a speed limit (up to 300 km/h or 200 MPH) for the speed alert. When the vehicle exceeds the specified speed limit, the dashcam beeps and switches to event recording. After saving one event recording file the dashcam switches back to normal mode recording.

Battery Protection (Optional - Hardwiring Power Cable installation only)

When the battery protection is on, power is supplied to your BlackVue while the vehicle is off (ACC+ off) and also prevents the vehicle from battery discharge while it is parked. When enabled, BlackVue will automatically power down according to the set cut-off timer and voltage.

Note

- Recommended settings for low voltage cut-off is 12V or higher during winter. - If battery protection is off, BlackVue will not operate when the vehicle is turned off (ACC+ off).

User text overlay

You can create a user text overlay of up to 20 characters using a combination of English letters (A – Z, a – z), numbers (0 – 9), and symbols (:;'/+_-()\$#). The text is overlaid in the top-left corner of the recorded videos.

➤ Wi-Fi settings

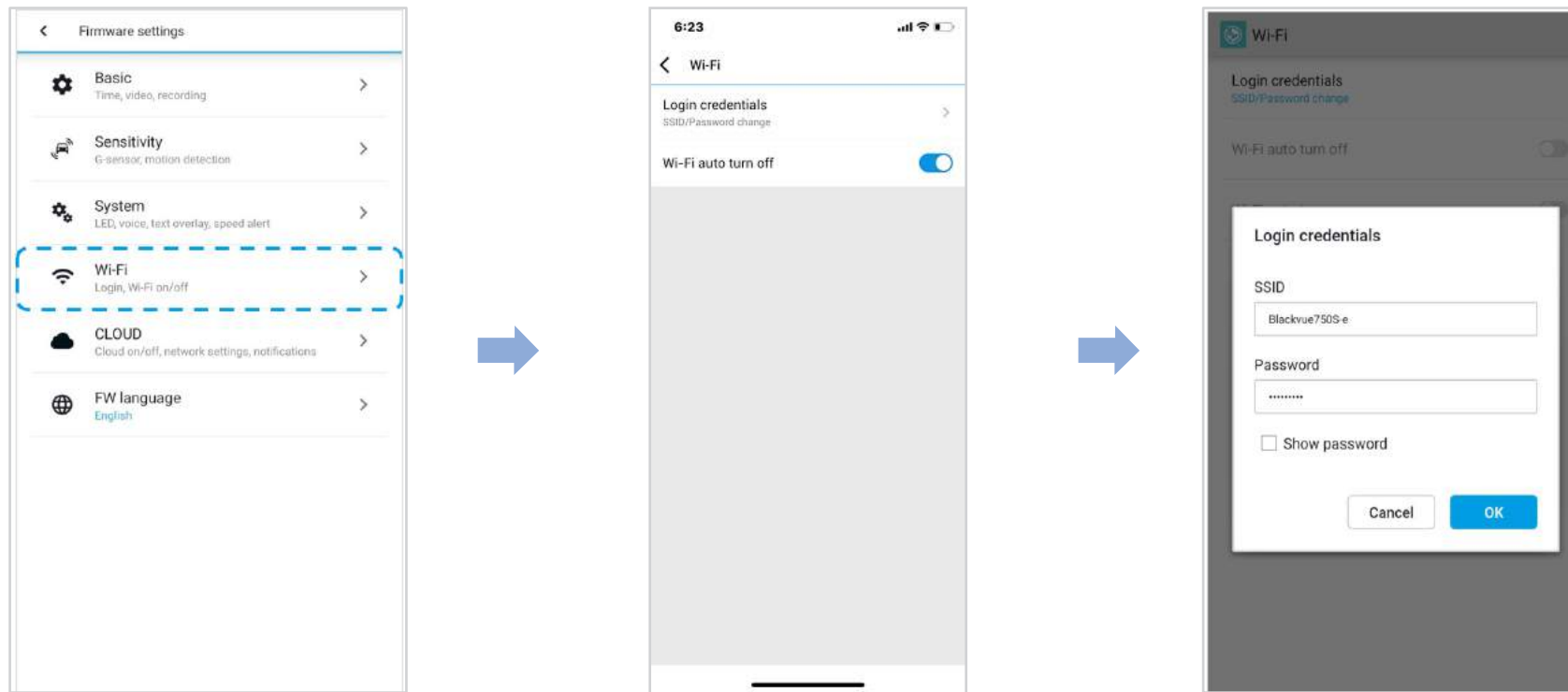

Login credentials

You can change the dashcam's SSID and Wi-Fi login password.

Wi-Fi auto turn off

Wi-Fi will automatically switch on when you turn on the dashcam and remain on. You can adjust the settings for Wi-Fi to automatically turn off.

	ON	OFF
Wi-Fi auto turn off	Wi-Fi turns off if it is inactive for 10 minutes.	Wi-Fi does not turn off automatically.

➤ Cloud settings

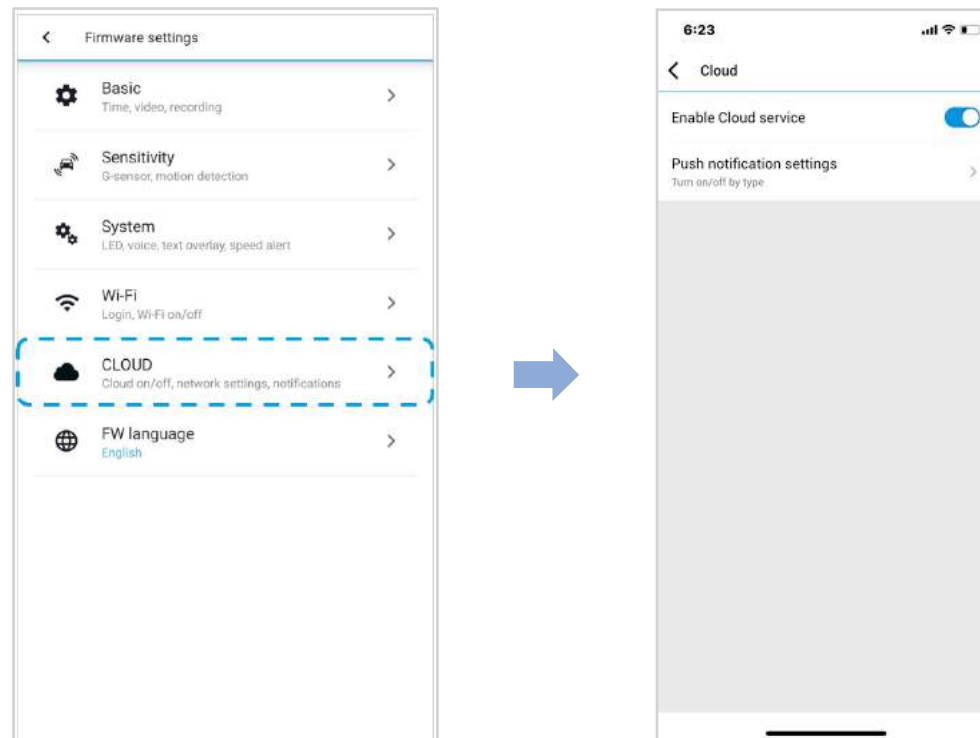

Enable Cloud Lite service

If you don't use the Cloud Lite service you can turn it off.

Push notification settings

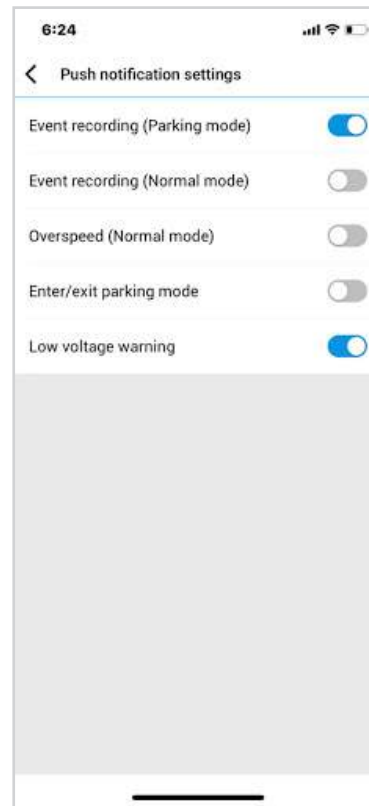

You can customize when you want to receive push notifications.

FW Language

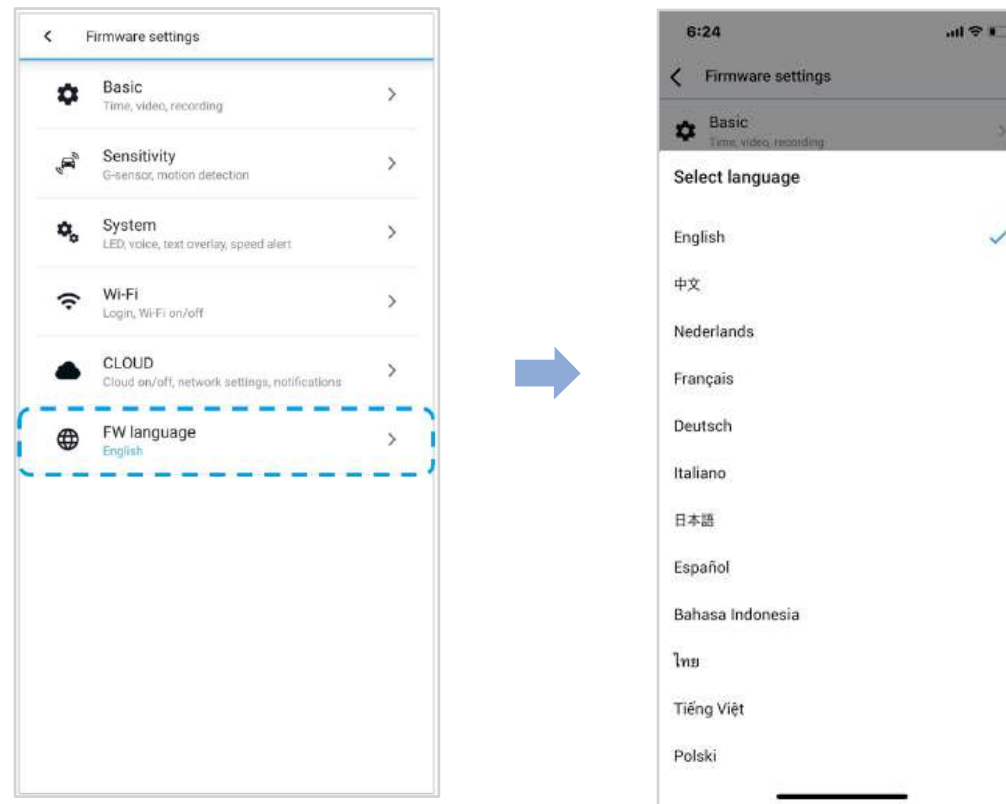

You can change the Firmware language of your dashcam.

▶ Changing settings using your computer (Windows/macOS)

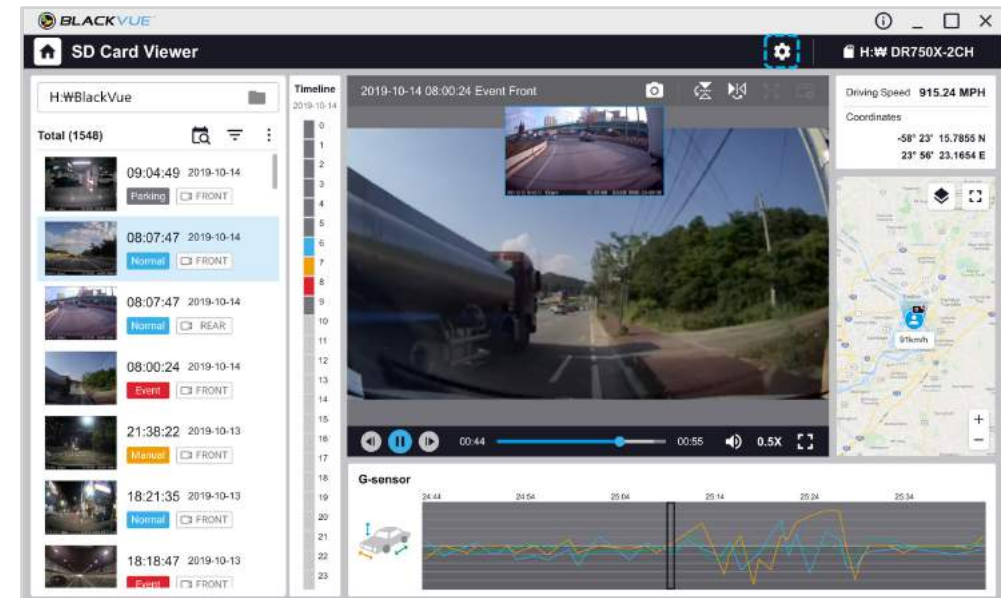
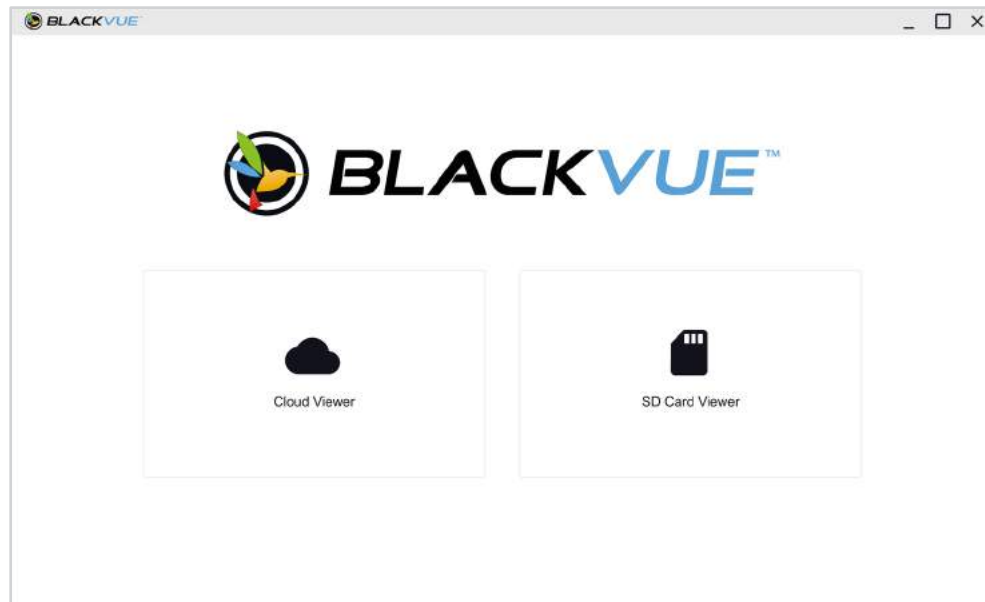

Click on the  Settings button to open the BlackVue settings panel. You will be able to change most of the BlackVue settings to customize its operation.

BlackVue Viewer settings

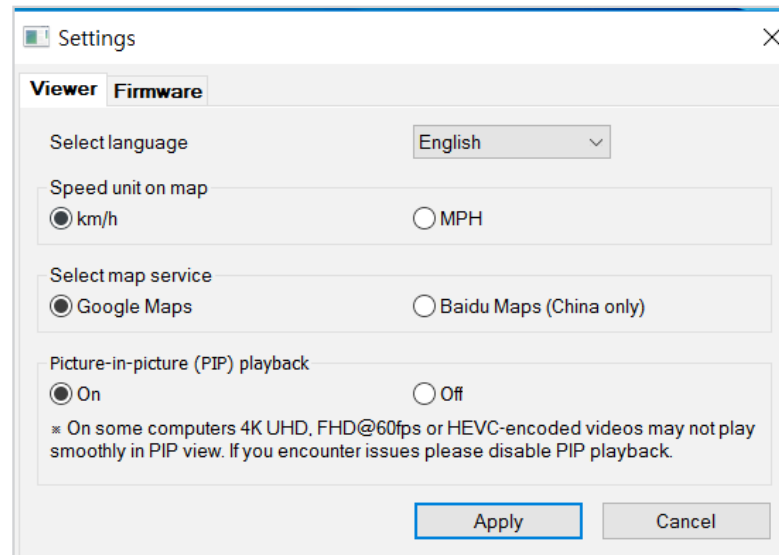

Select language

Select your preferred language for the BlackVue Viewer interface from the dropdown list.

Speed unit on map

Change the speed unit displayed on the map.

Select map service

Change the mapping service used.

Picture-in-picture(PIP) playback

On some computers videos may not play smoothly in PIP view. If you encounter issues please disable PIP playback.

Firmware settings

Select your preferred language for the firmware from the FW language dropdown list. The audio announcements by the dashcam will be in the selected language.

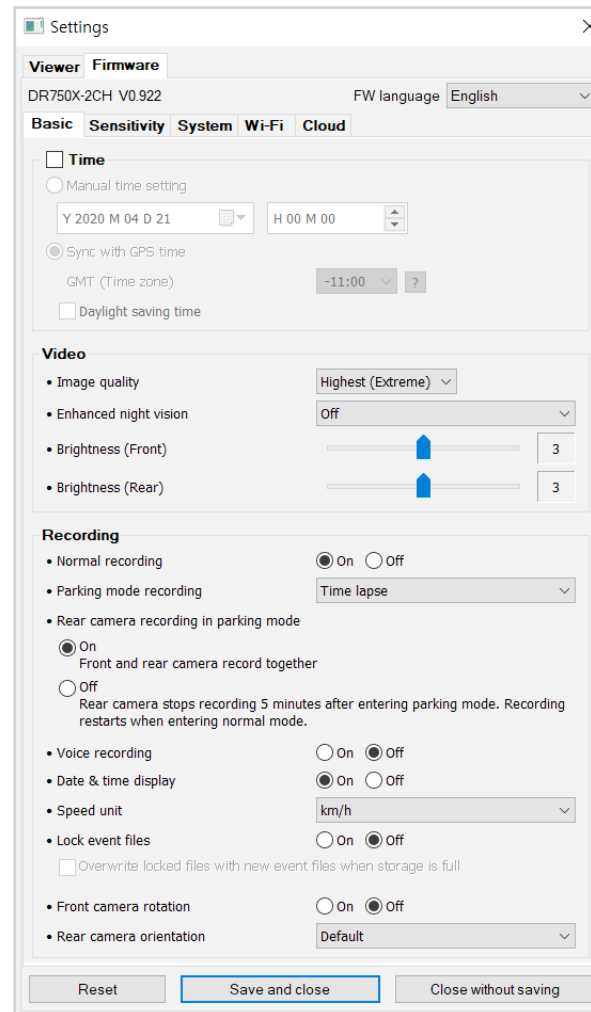

Caution

- Please backup necessary recordings before changing **time** or **image quality** settings. If any of the aforementioned settings are changed and saved, the dashcam will format the microSD card and delete all recordings stored on the card including locked event files in order to ensure optimal performance.

Basic settings

Time settings

Select your time zone to auto-sync with GPS time or you can set the time and date manually after enabling **Manual time setting**.

 **Note**

- The factory setting is GMT -11.

Some examples of GMT time offsets are:

- GMT-7: Los Angeles
- GMT-4: New York
- GMT+0: London
- GMT+1: Paris
- GMT+3: Moscow
- GMT+8: Singapore
- GMT+9: Seoul
- GMT+10: Sydney

If you are unsure of your GMT offset please look up your city on <https://greenwichmeantime.com/>

* Selecting **Daylight saving time** will advance the clock by one hour.

- When setting the time manually, please set to the expected time you will use the BlackVue (not the present time).

■ Video settings

– Resolution

Resolution and frame rate is fixed at "FHD@30 + FHD@30". This means the front camera records Full HD video at 30 frames per second, and the rear camera records Full HD video at 30 frames per second.

Note

- Frame rate may vary during Wi-Fi streaming.

– Image quality

You can adjust the recording image quality (bit rate) settings. Choose between:

- Highest (Front: 12 Mbit/s, Rear: 10 Mbit/s)
- High (Front: 10 Mbit/s, Rear: 8 Mbit/s)
- Normal (Front: 8 Mbit/s, Rear: 6 Mbit/s)

Increasing the image quality will increase the size of the video files. Loading and copying time will increase accordingly.

– Enhanced night vision

The dashcam has an intrinsic night vision feature. If you want to enhance it, enable Enhanced night vision.

– Brightness (Front)

You can adjust the recording brightness level of the front camera.

– Brightness (Rear)

You can adjust the recording brightness level of the rear camera.

■ Recording settings

– Normal recording

When turned off the dashcam does not record in normal mode.

– Parking mode recording

If enabled, the dashcam switches from normal mode to parking mode when the vehicle is turned off (ACC+) or stationary for 5 minutes (G-Sensor). There are two parking mode options. Choose "Motion & Impact detection" to save a parking recording when motion is detected in the dashcam's field of view. If the G-sensor detects an impact/bump the dashcam saves a separate event recording file.

– Rear camera recording in parking mode

When turned on, the front and rear camera record together.

When turned off, the rear camera stops recording 5 minutes after entering parking mode. Rear camera recording restarts when entering normal mode.

– Voice recording

When turned off the dashcam does not record audio.

– Date & time display

Turn on/off the date and time display on videos.

– Speed unit

Select km/h, MPH, or turn off.

– Video segment length

Video segment length is fixed at 1 minute.

– **Lock event files**

Turning on this option will lock the following recording types and stop them from being overwritten by newer recordings:

- Impact event recordings during normal and parking mode (E)

A maximum of 50 files can be locked. Once this limit is reached, to lock new recordings please review locked files on the microSD card and free up space, or enable 'Overwrite locked event files when full' to allow the oldest locked files to be overwritten.

– **Front camera rotation**

If you installed the front camera in a flipped position, use this setting to rotate the front camera image 180°.

– **Rear camera orientation**

Use this setting to rotate the rear camera image 180° or mirror the video.

□ Sensitivity settings

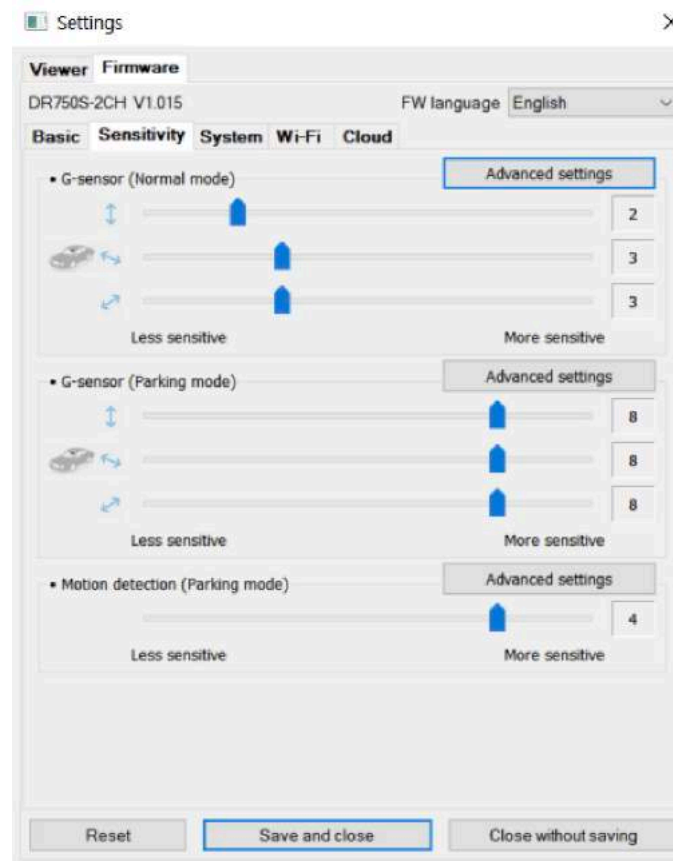

■ G-Sensor (Normal mode) / G-Sensor (Parking mode)

The G-sensor measures the movement of your vehicle through 3 axes – up and down, side to side, and front and back. When the G-sensor detects significant or sudden movement (such as an impact or collision) it will trigger an event recording. You can adjust the sensitivity so minor incidents and bumps don't trigger an event recording. To turn off event recordings by impact detection set the G-sensor sensitivity to off.

■ Motion detection (Parking mode)

In parking mode the dashcam continuously buffers video and saves a parking recording when motion is detected in the dashcam's field of view.

You can adjust the sensitivity of the motion detection so minor motion caused by wind or rain doesn't trigger a recording. Please take into account your vehicle's surroundings when adjusting the sensitivity.

■ Advanced sensitivity settings for normal and parking mode

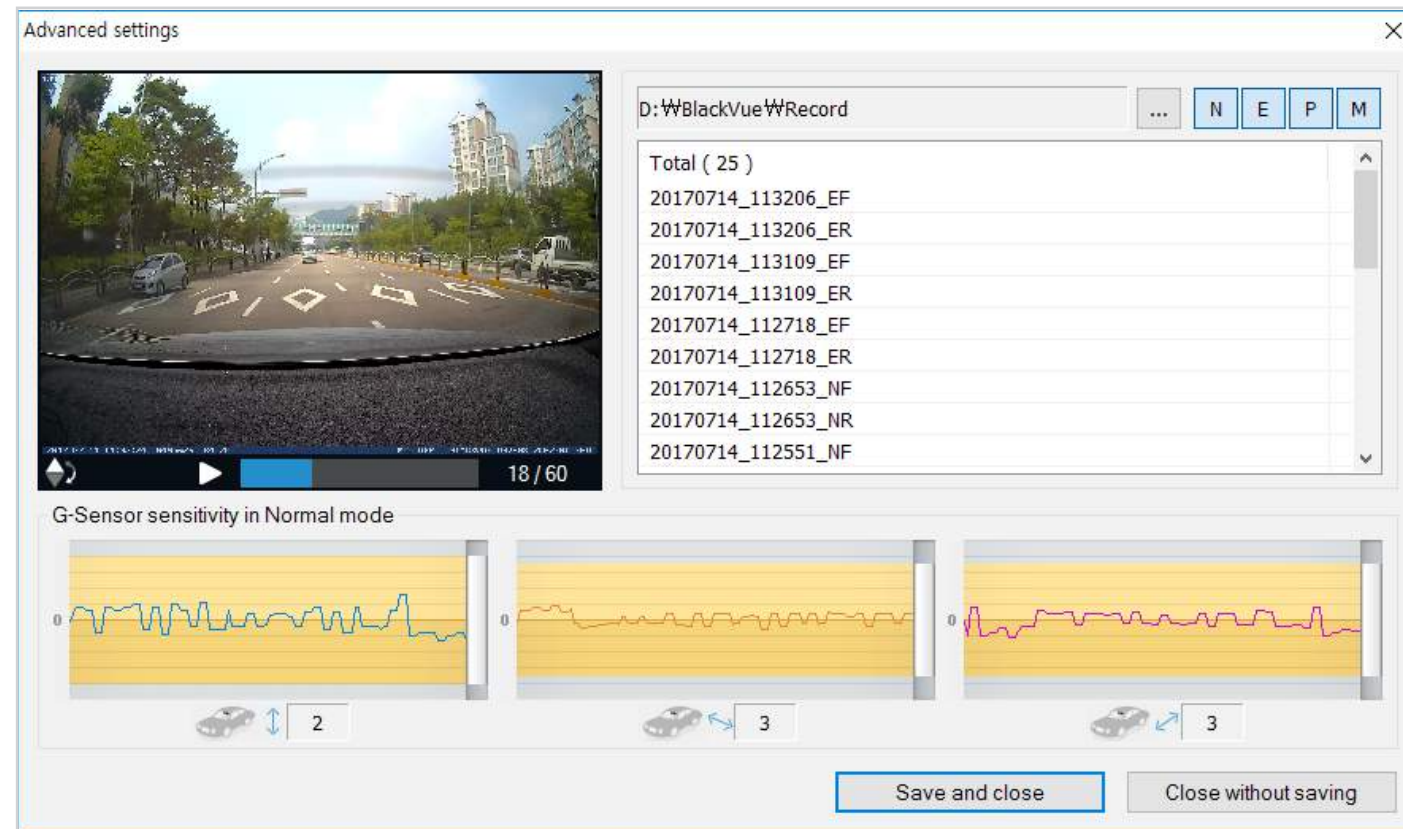

Advanced sensitivity settings allows you to fine-tune the event recording G-Sensor threshold, while watching pre-recorded G-Sensor data and video as a reference.

- 1 Click the **Advanced settings** button.
- 2 Double click the video from the list that you want to use as a G-Sensor data reference.
- 3 Set the thresholds by adjusting the control bars next to each G-Sensor axis. Any G-Sensor data that crosses over the threshold on any of the 3 axes will trigger an Event recording.

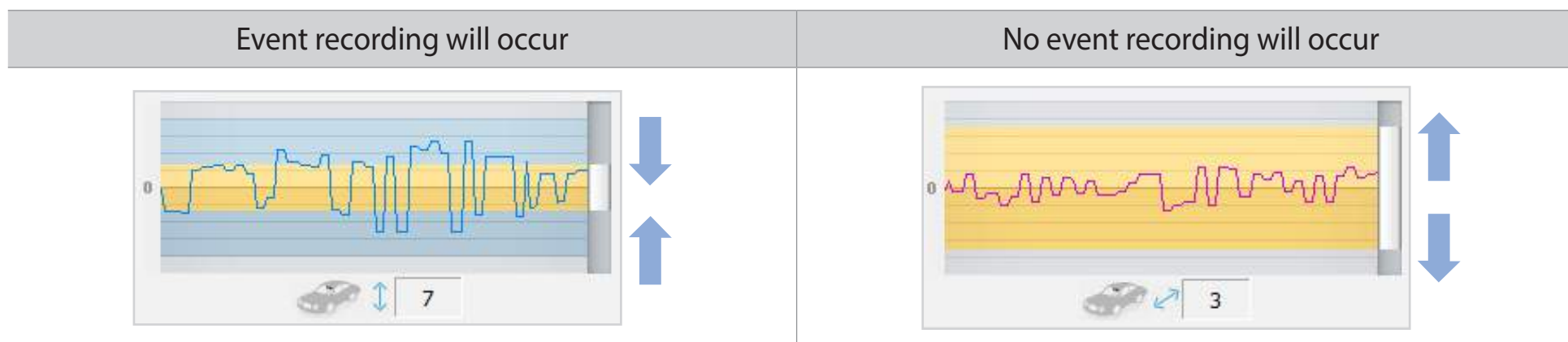

- 4 Click **Save and close**.

System settings

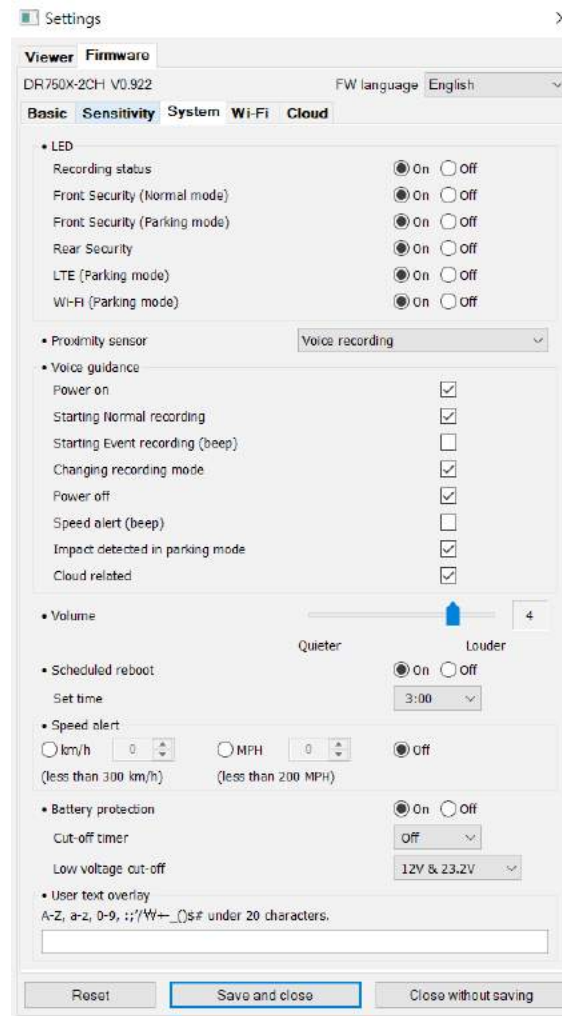

LED

– Recording status

You can turn the recording status LED on/off.

– Front security (Normal mode)

You can turn the front security LED on/off for normal mode.

– Front security (Parking mode)

You can turn the front security LED on/off for parking mode.

– Rear security

You can turn the rear security LED on/off.

– LTE (Parking mode)

You can turn the LTE LED on/off for parking mode.

– Wi-Fi (Parking mode)

You can turn the Wi-Fi LED on/off for parking mode.

■ Voice guidance

You can adjust the voice guidance (announcements) you want to hear.



Note:

Impact detected in parking mode voice alert notifies when exiting parking mode if an impact had been detected during parking mode, however, it ignores any impact detected within three minutes before exiting parking mode.

■ Volume

You can adjust the volume of the voice guidance (announcements).

■ Scheduled Reboot

The dashcam reboots automatically once-a-day if in parking mode at the set time for improved stability. If the dashcam is recording at the set time, the scheduled reboot is skipped.

You can enable/disable and change the time for scheduled rebooting. Default time is 03:00 am.

■ Speed alert

Set a speed limit (up to 300 km/h or 200 MPH) for the speed alert. When the vehicle exceeds the specified speed limit, the dashcam beeps and switches to event recording. After saving one event recording file the dashcam switches back to normal mode recording.

■ Battery Protection (Hardwiring Power Cable installation only)

When the battery protection is on, power is supplied to your BlackVue while the vehicle is off (ACC+ off) and also prevents the vehicle from battery discharge while it is parked. BlackVue will automatically power down according to the set cut-off timer and voltage.

Note

- Recommended settings for low voltage cut-off is 12V or higher during winter. - If battery protection is off, BlackVue will not operate when the vehicle is turned off (ACC+ off).

■ User text overlay

You can create a user text overlay of up to 20 characters using a combination of English letters (A – Z, a – z), numbers (0 – 9), and symbols (;:/+_-()\$#). The text is overlaid in the top-left corner of the recorded videos.

Wi-Fi settings

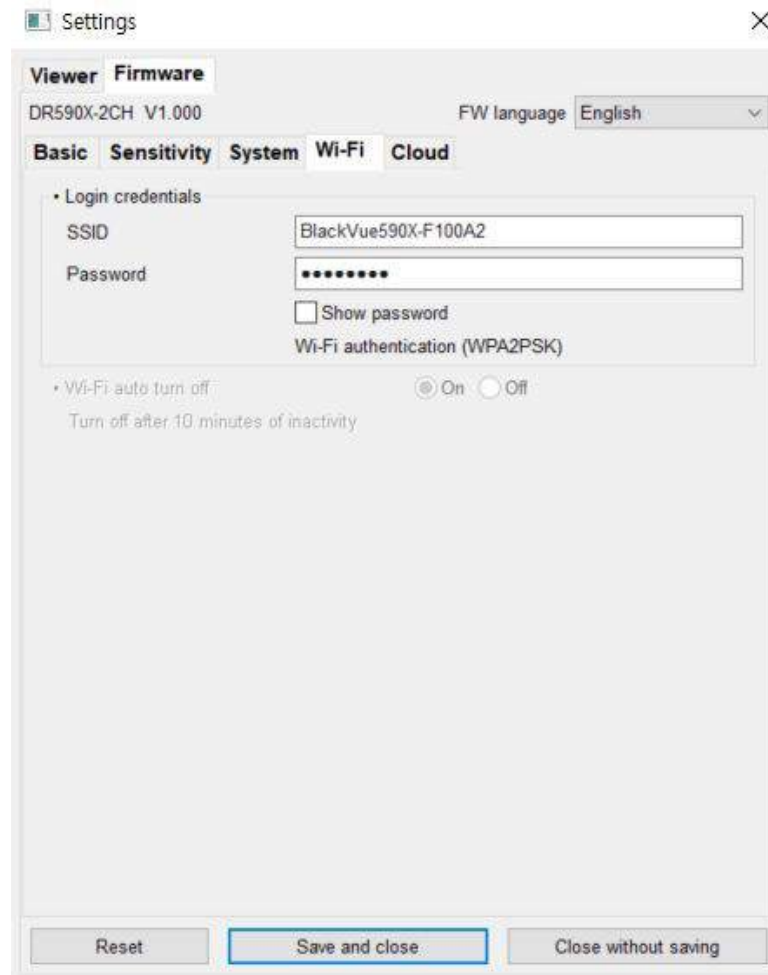

Login credentials

You can change the dashcam's SSID and Wi-Fi login password.

Wi-Fi auto turn off

Wi-Fi will automatically switch on when you turn on the dashcam and remain on. You can adjust the settings for Wi-Fi to automatically turn off.

	ON	OFF
Wi-Fi auto turn off	Wi-Fi turns off if it is inactive for 10 minutes.	Wi-Fi does not turn off automatically.

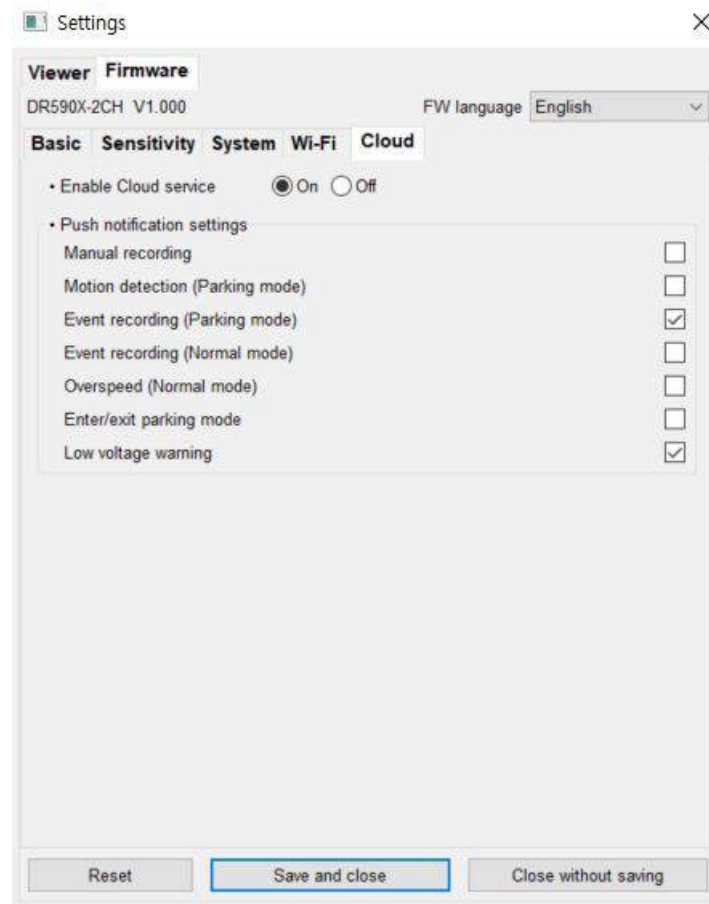

■ Push notification settings

You can customize when you want to receive push notifications.

□ Applying the settings

You can automatically apply the configuration by inserting the microSD card into the BlackVue dashcam and turning it on. Configure the settings before using the dashcam.

To reset all settings to their defaults press the **Reset** button at the bottom of the settings panel.

About the Cloud Service

Using a BlackVue connectivity module device (CM100GLTE-M), you can connect your dashcam to the internet and take advantage of the following features in the BlackVue app and BlackVue Cloud Viewer:

Live Location – When sending live image, it shows you location information of the live image.

Impact Notifications with Thumbnail – Be notified on your smartphone when something happens to your car (5 times per day at free of charge / you will receive text notification alternatively after the 5 times) .

Live Image – Watch your dashcam's live image capture (100 times per month at free of charge).

Connect to BLACKVUE CLOUD (Optional)

If you don't have a BlackVue connectivity module (CM100GLTE-M), or if you don't want to use the BLACKVUE CLOUD service, you can skip this step.

If you have a BlackVue connectivity module, you can use the BlackVue app to connect to BLACKVUE CLOUD and see in real-time where your car is and the dashcam's live image.

For more information about using the BlackVue app, please download the BlackVue app Manual from www.blackvue.com > **Support** > **Downloads**.

1 Create an account

- (i) Open the BlackVue app.
- (ii) Tap the  button in the top-left corner and select **Create account**.
- (iii) Enter your name, e-mail address and choose a password. Re-enter your password and press **Sign up**.
- (iv) You will receive an e-mail. Click the link in the email to finish creating your account.

2 Register your dashcam with your account

- (i) In the BlackVue app select **CLOUD** and login to your account.
- (ii) Tap **Yes** to enable push notifications (this setting can be adjusted at any time later).
- (iii) Select **Register new camera**.
- (iv) Register your camera using one of the following methods:

QR Code: Press **Scan QR Code** and line up the QR Code on your smartphone's screen.

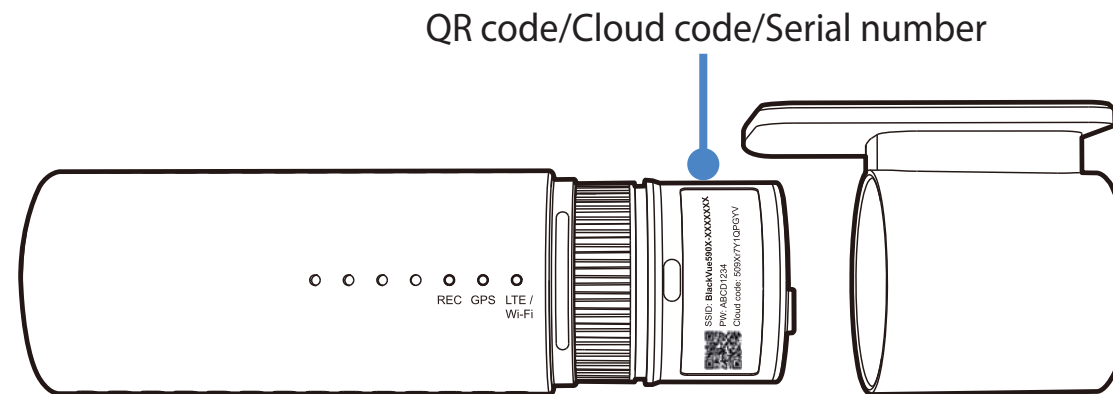

or

Manual registration: Enter your camera's Serial number and Cloud code and press **Register**.

- (v) The app will ask for your permission to access your dashcam's GPS data. If you **allow** access the app will be able to show you your dashcam's location and speed. If you **don't allow** access you won't be able to see your dashcam's location and speed (you can allow access later in Privacy settings).

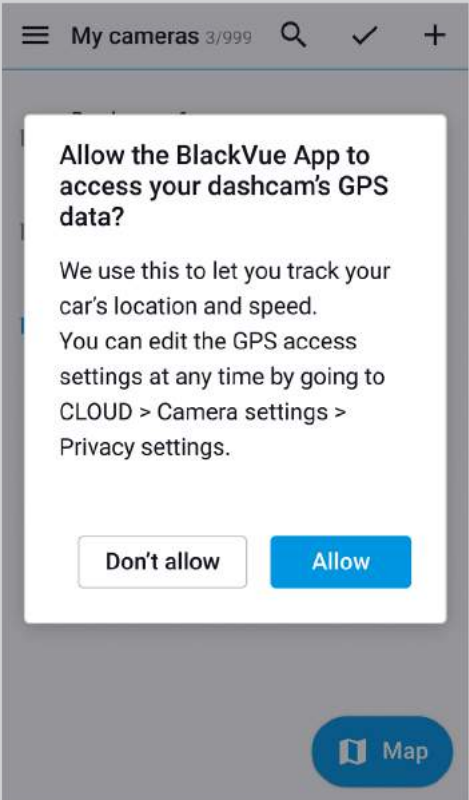

3 Connect your BlackVue dashcam to Cloud connectivity (Using CM100GLTE-M)

Make sure your BlackVue dashcam and connectivity module is connected. Then, follow the below steps for SIM registration.

- (i) Locate the SIM card slot. Unscrew the bolt from SIM slot cover. Then, unmount the SIM slot by using a SIM eject tool. Insert SIM in the SIM slot. Mount the SIM slot back in the connectivity module, then, screw the bolt to hold SIM slot cover.
- (ii) "Pair" your smartphone with the BlackVue dashcam via direct Wi-Fi.
- (iii) Open the BlackVue app and select WI-FI > .

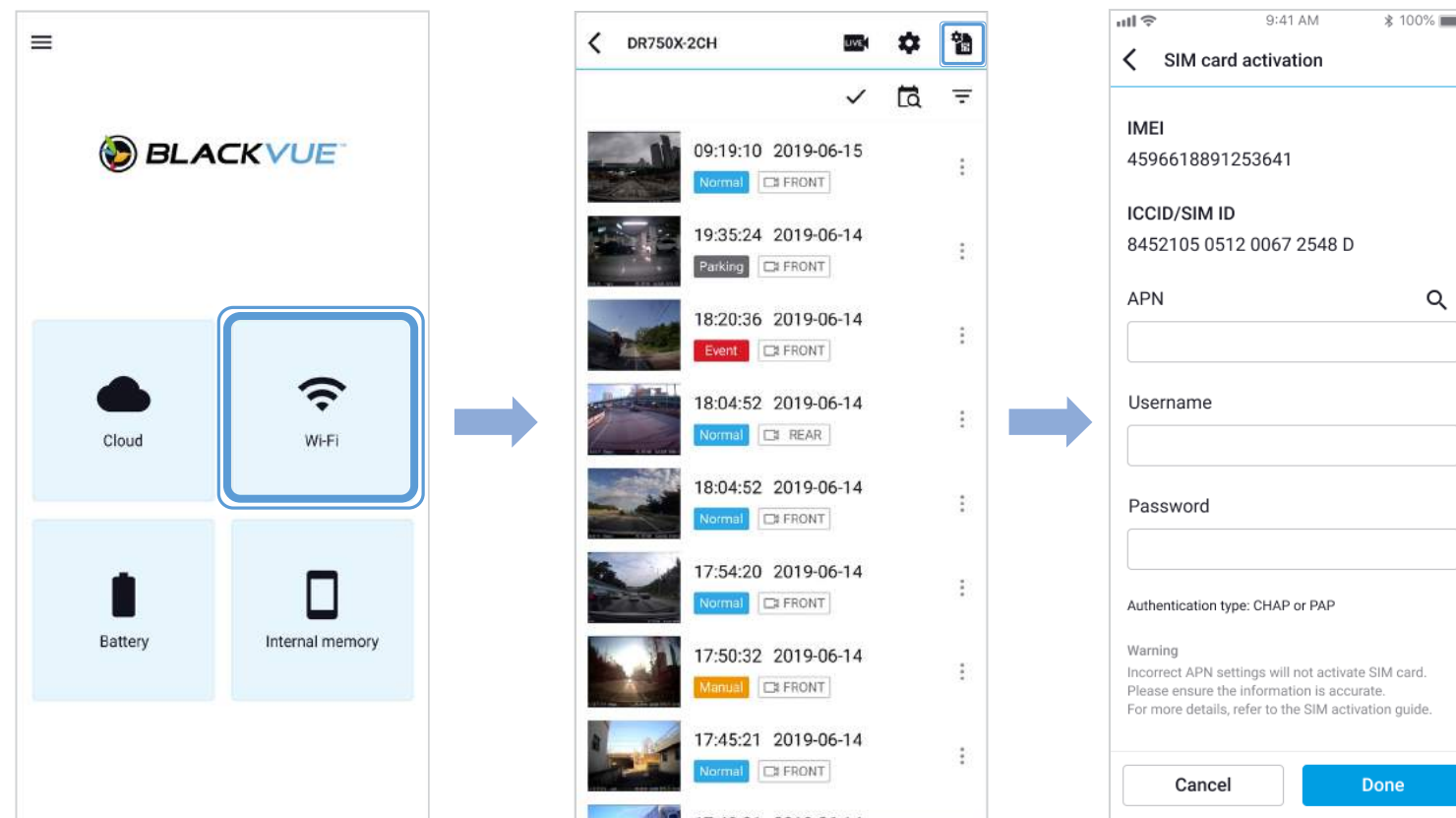

1. To activate your SIM card, Please input the below APN information in the blank of the SIM card activation page.

APN : internet.lte.cxn

2. You only need to input APN as described above, you neither need to input user name nor password.

 **Note**

- Cloud lite service is free of charge to the user for 1 year.
For who wants to continue to use Cloud lite service, A payment plan must be subscribed.
- For more details, please check our blackvuewebsite. (www.blackvue.com)

 **Note**

- To use the BlackVue Cloud Lite Service, SIM card must be properly activated for Internet access via LTE-M network.
- When the dashcam is connected to internet, you can use BlackVue Cloud features such as remote Live Image and Live Location, Impact Notifications with Thumbnail on BlackVue app and BlackVue Viewer.
- Some Cloud features may not work when surrounding temperature is high or/and LTE speed is slow.
- For more information about using the BlackVue app, please download the Cloud Manual from www.blackvue.com > **Support** > **Downloads**.

Optional accessories

▶ Parking mode battery (Optional)

Parking mode is supported only if you use a Hardwiring power cable or a parking mode battery (ex. Power Magic Ultra Battery or Power Magic Battery Pack). To record Video when the engine is turned off without using the vehicle's battery, you can install a parking mode battery.

▶ Power Magic Battery (B-112)

The Power Magic Battery pack B-112 powers a single dashcam for up to 12 hours after 1 hours of rapid charging. When the engine is off the battery pack powers the dashcam. When the engine is on the dashcam is powered directly from the vehicle's battery and the battery pack charges.

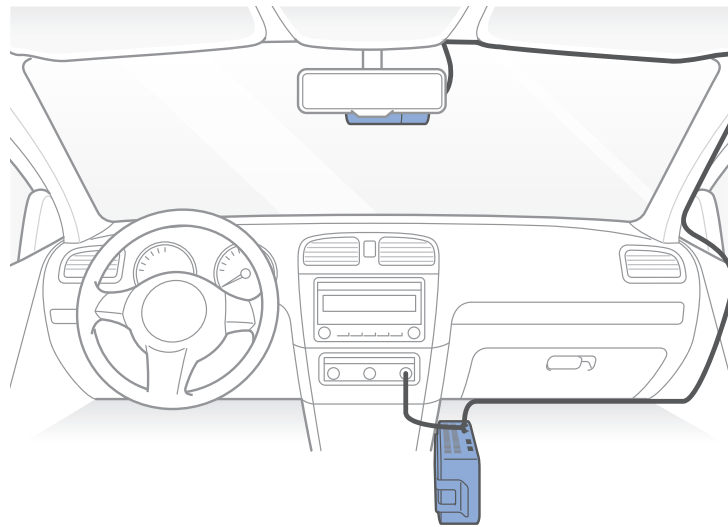

➤ Power Magic Ultra Battery (B-124X)

Power Magic Ultra Battery reaches a full charge in a record 40minutes when hardwired. Parking mode can last more than 24hours with a single-channel BlackVue. Compatible with the free BlackVue Battery Manager app.

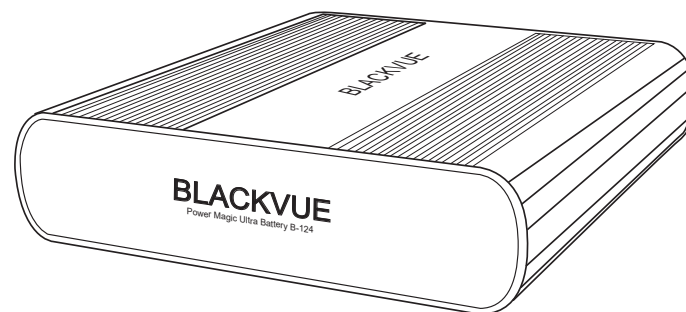

Note

- Double you capacity with the optional Expansion battery.
- Power Magic Ultra Battery recharges with ignition on and powers your dashcam when ignition it off.
- For more detailed information, please check Blackvue hompage(www.blackvue.co.kr)

▶ External connectivity module (Optional)

To stay connected to the BlackVue Cloud over cellular data network, you can install an external connectivity module CM100GLTE-M.

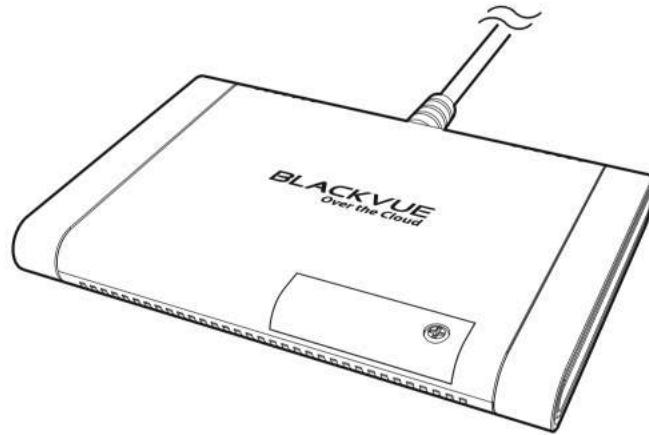

Note

- You must subscribe to your recommended local network carrier for LTE-M services.
- You will be subscribed to the BlackVue Cloud lite service at free of charge.
- BlackVue Connectivity Module (CM100GLTE-M) may not be supported in some countries. Please refer to BlackVue website to see availability.

Changing / resetting direct Wi-Fi SSID and password

The dashcam's Wi-Fi SSID and password can be changed/reset using one of the following methods.

On-device Wi-Fi SSID and password reset

Press and hold the Wi-Fi button on the dashcam, for 5 seconds and once voice instructions start, release the button. Then press once again to reset the Wi-Fi SSID and password to default.

* The default Wi-Fi SSID and password can be found labeled on the front camera when you remove it from its mount.

➤ Change Wi-Fi SSID and password over the Cloud

1 Login to the BlackVue app.

2 Select **CLOUD**.

📝 Note

- You can access FW settings Over the Cloud only when the dashcam is ON and connected to the internet (Cloud). A blue colored icon means the dashcam is connected to the Cloud while a grey colored icon means that the dashcam is not connected to the Cloud.

3 Tap **:** next to your camera name and select **Settings > Firmware > Wi-Fi > Login credentials**.

You can change the camera's SSID and Wi-Fi login password.

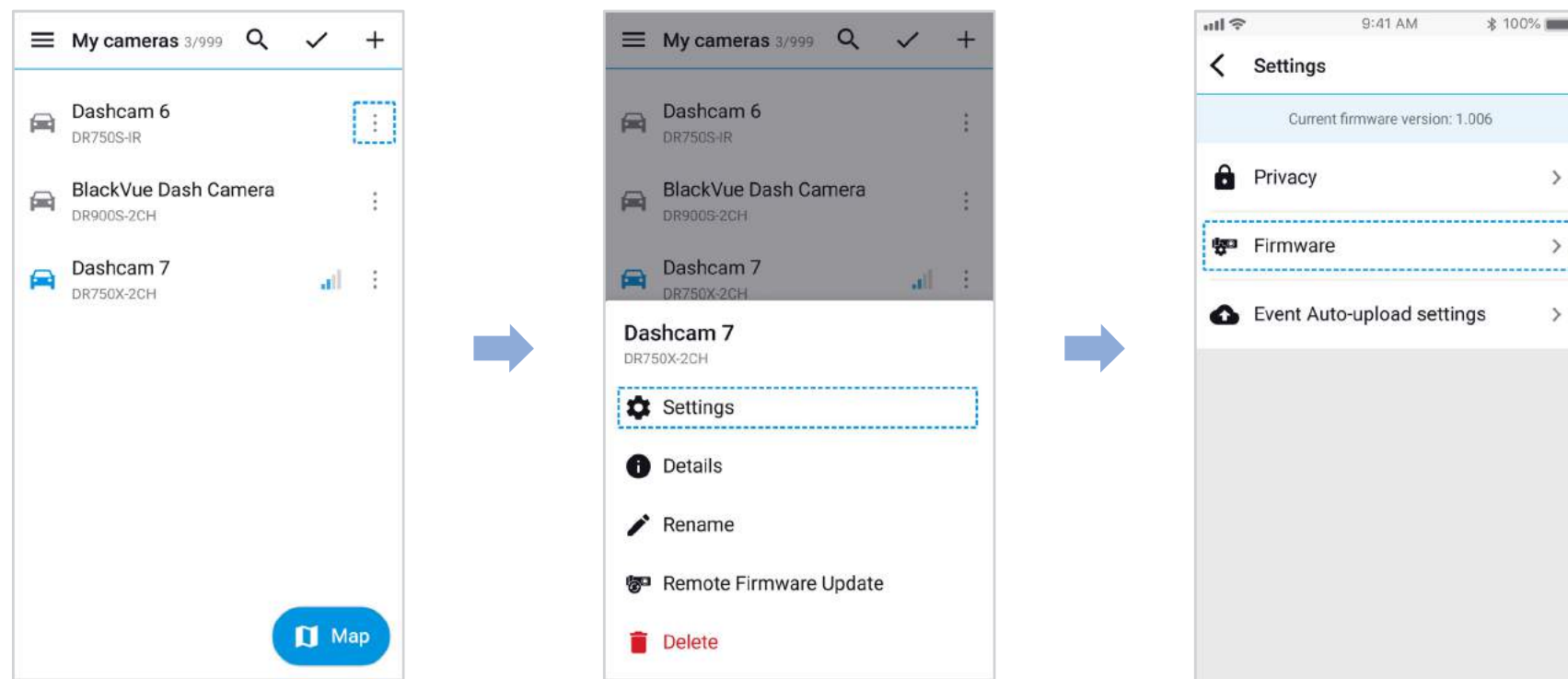

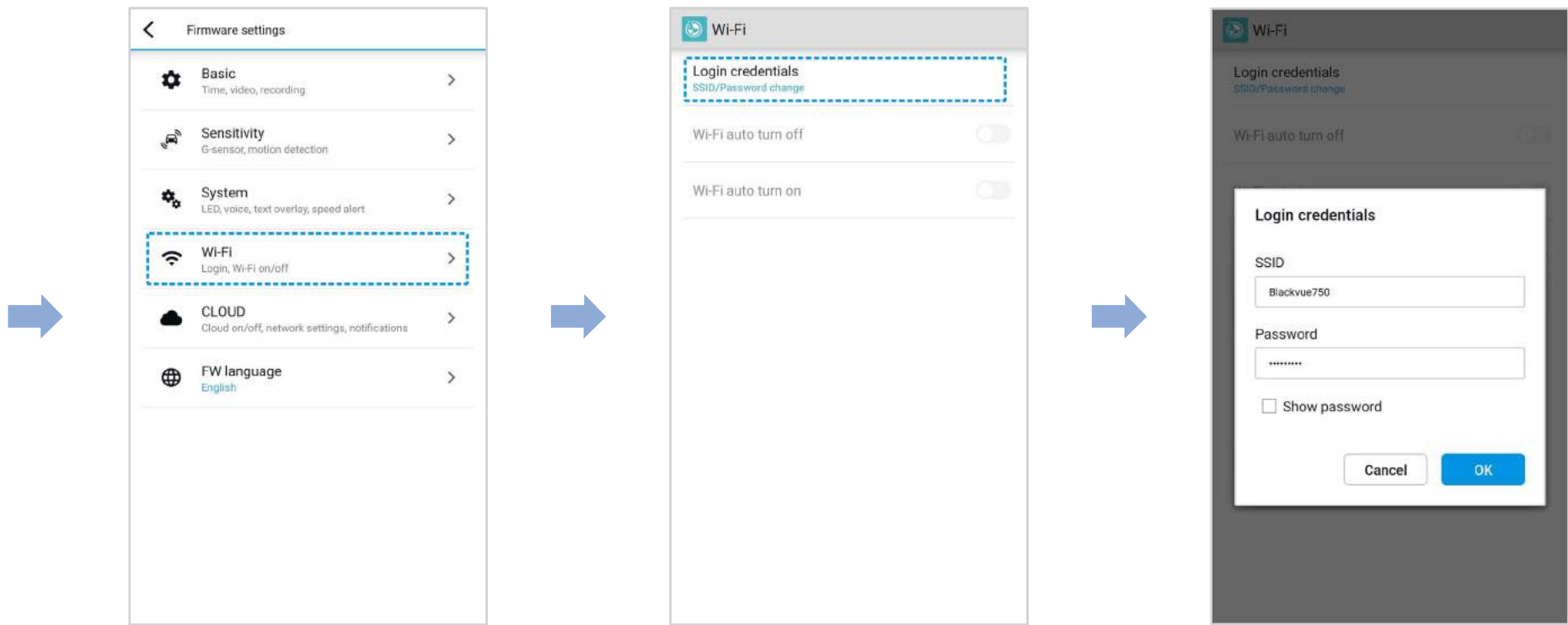

4 Go back to the Firmware settings menu, tap  and tap **Save**.

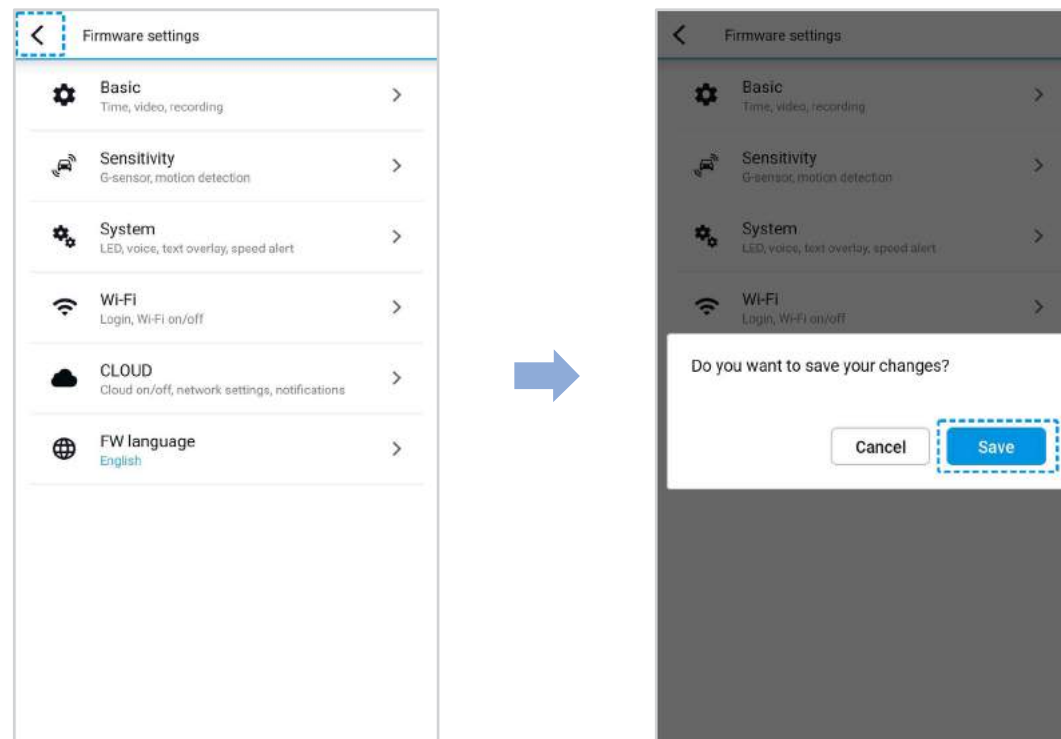

Change the Wi-Fi password using BlackVue Viewer (Windows/macOS)

- 1** Remove the microSD card from the dashcam.
- 2** Insert the card into the microSD card reader and connect it to a computer.
- 3** Launch BlackVue viewer.
*You can download **BlackVue Viewer** from www.blackvue.com > **Support** > **Downloads** and install it on your computer.
- 4** In BlackVue Viewer click on the  Settings button to open the BlackVue settings panel.
- 5** Click the **Firmware** tab, then the **Wi-Fi** tab and under **Login credentials** change the password.
- 6** Click **Save and close**.

Product specifications

Model Name	DR590X-2CH
Color/Size/Weight	Front: Black/Width 111.8 mm x Height 34 mm/87.8 g Rear: Black/Width 67.4 mm x Height 25 mm/20.3 g
Memory	microSD Card (32 GB/64 GB/128 GB/256 GB)
Recording Modes	Normal recording, Event recording (when impact is detected in normal and parking mode), Manual recording and Parking recording (when motion is detected) * When using Hardwiring Power Cable, ACC+ will trigger parking mode. When using other methods, G-sensor will trigger parking mode.
Camera	Front: STARVIS™ CMOS Sensor (Approx. 2.1 M Pixel) Rear: CMOS Sensor (Approx. 2M Pixel)
Viewing Angle	Front: Diagonal 139°, Horizontal 116°, Vertical 61° Rear: Diagonal 136.8°, Horizontal 111.3°, Vertical 57.5°
Resolution/Frame Rate	<Front - Rear> Full HD @30fps - Full HD @30fps * Frame rate may vary during Wi-Fi streaming.
Image Quality	Highest, High, Normal
Video Compression Mode	MP4
Wi-Fi	Built-in (802.11 b.g.n)
GPS	External (Optional - Dual Band: GPS, GLONASS)
LTE	External (Optional - Cat.M1)
Microphone	Built-in
Speaker (Voice Guidance)	Built-in
LED Indicators	Front: Recording LED, GPS LED, LTE/Wi-Fi LED, Front Security LED Rear: Rear Security LED
Button	Wi-Fi button: * Press once to turn on/off Wi-Fi.
Sensor	3-Axis Acceleration Sensor

Backup Battery	Built-in super capacitor
Input Power	DC 12V-24V (DC Plug (Ø3.5 x Ø1.1)) to Wires (Black: GND/Yellow: B+/Red: ACC)
Power Consumption	<p>Normal Mode (WiFi On/GPS On): 370mA/hour Normal Mode (WiFi Off/GPS On): 330mA/hour Parking Mode (WiFi On/GPS Off): 340mA/hour Parking Mode (WiFi Off/GPS Off): 300mA/hour</p> <p>When connected to CM100GLTE-M (Optional) Normal Mode (WiFi On/GPS On): 440mA/hour Normal Mode (WiFi Off/GPS On): 400mA/hour Parking Mode (WiFi On/GPS Off): 370mA/hour Parking Mode (WiFi Off/GPS Off): 330mA/hour * Actual power consumption may vary depending on use conditions and environment.</p>
Operation Temperature	-20 °C – 70 °C (-4 °F – 158 °F)
Storage Temperature	-20 °C – 80 °C (-4 °F – 176 °F)
High Temperature Cut-Off	Approx. 70 °C (158 °F)
Certifications	Front: FCC, CE, RoHS, Telec, WEEE, IC Rear: FCC, CE, RoHS, WEEE
Software	BlackVue Viewer * Windows 7 or higher and Mac Yosemite OS X (10.10) or higher
Application	BlackVue Application (Android 5.0 or higher, iOS 9.0 or higher)
Others	Adaptive Format Free File Management System

* STARVIS is a trademark of Sony Corporation.

Recording time

Your dashcam will automatically turn on and start recording when it is connected to a power source.

Memory Capacity	Image Quality	Resolution (Front + Rear)
		Full HD @30fps + Full HD @30fps
32GB	Highest	2 HR 50 MIN
	High	3 HR 40 MIN
	Normal	4 HR 40 MIN
64GB	Highest	5 HR 40 MIN
	High	7 HR 20 MIN
	Normal	9 HR 20 MIN
128GB	Highest	11 HR 20 MIN
	High	14 HR 40 MIN
	Normal	18 HR 40 MIN
256GB	Highest	22 HR 40 MIN
	High	29 HR 20 MIN
	Normal	37 HR 20 MIN
Bitrate (Mbps) Front + Rear	Highest	12 + 10
	High	10 + 8
	Normal	8 + 6

Note

- If the microSD card is full, older files are deleted first to make space for newly-recorded videos.
- Total recording time is different depending on the memory capacity of the microSD card and the resolution of the video.

Disposal of your BlackVue dashcam



1. All electrical and electronic products should be disposed of separately from the municipal waste stream via designated collection facilities appointed by the government or the local authorities. Contact local authorities to learn about disposal and recycling options available in your area.
2. The correct disposal of your BlackVue dashcam will help prevent potential negative consequences for the environment and human health.
3. For more detailed information about disposal of your BlackVue dashcam, please contact your city office, waste disposal service or the shop where you purchased the product.

Customer Support

For customer support and firmware updates please visit www.blackvue.com

You can also email a Customer Support expert at cs@pittasoft.com

Before Requesting Service

Please back up all important files and data before requesting service. In order to service the dashcam it may be necessary to delete all files and data from the dashcam. All servicing is provided on the basis that the user has backed up all necessary files and data before requesting service. Therefore Pittasoft Co., Ltd. will not be responsible for the loss of any files or data.

Copyright & Trademark

- This instruction manual is protected by Copyright Law, and all rights to it are protected by law.
- It is prohibited to reproduce, copy, modify, or translate this instruction manual without permission.

 **BLACKVUE** BlackVue is the registered trademark of Pittasoft Co., Ltd. Pittasoft Co., Ltd. reserves all rights regarding all works related to the BlackVue brand such as product design, trademarks, and product-promotional videos. It is prohibited to reproduce, copy, modify, or use related works without permission. Any violation may be penalized in accordance with the relevant regulations.



FCC ID: YCK-DR590X-2CH / HVIN: DR590X-2CH / IC: 23402-DR590X2CH

Product | Car Dashcam
Model Name | DR590X-2CH
Manufacturer | Pittasoft Co., Ltd. / South Korea
Address | 4F ABN Tower, 331, Pangyo-ro, Bundang-gu, Seongnam-si, Gyeonggi-do, Republic of Korea, 13488
Customer Support | cs@pittasoft.com
Product Warranty | One-Year Limited Warranty

 facebook.com/BlackVueOfficial

 instagram.com/blackvueofficial

www.blackvue.com

Made in Korea