

SLIM - STORE BED HEADBOARD + BEDSIDES - QUEEN

MOOD

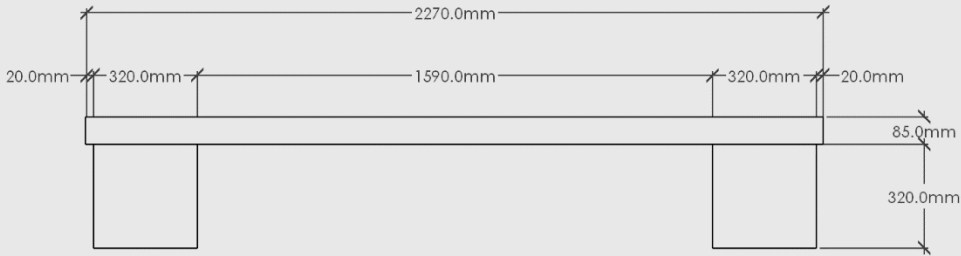

PLAN VIEW

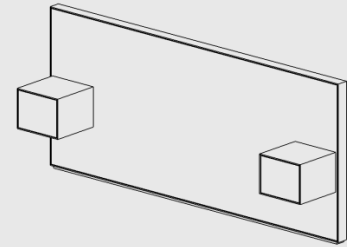

3D VIEW

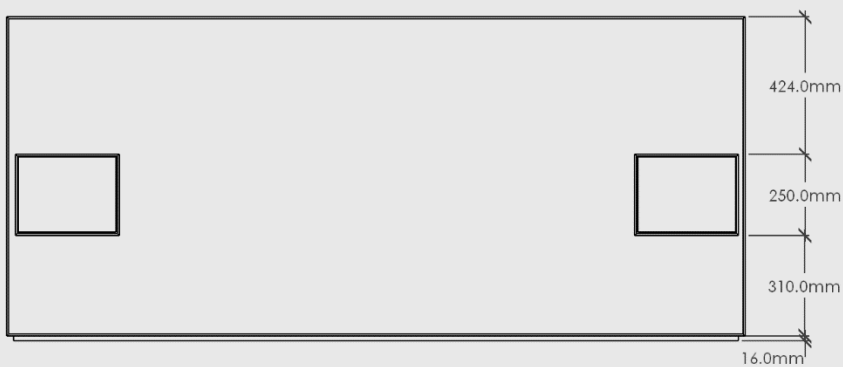

ELEVATION - FRONT

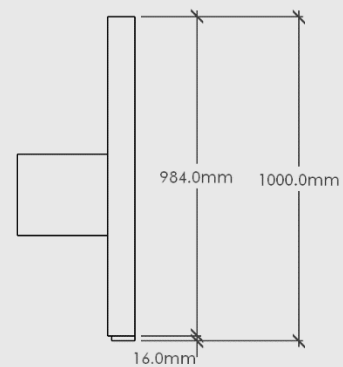

ELEVATION - SIDE

Slim - Store Bed Headboard + Bed sides - Queen

Dimensions: 2270mm Long x 85mm + 320mm Wide x 1000mm High

Shell/Fronts: Chosen Timber Veneer on 18mm Birch Plywood. Stained Oiled Edges to match.

Carcass: 16mm SupaBlack Carcass Grade Plywood with 1mm Black Edging

Hardware: Innobox 270mm x 86mm White Steel German Made Runners or similar.

Handle: Push to Open

Leg: N/A

Colour Options:

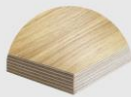

Oak



Walnut

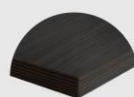

Black Oak

Push to open handle can be disabled to add on your chosen handle.

Headboard can be mounted on wall. Cleats are provided for installation.

Package Dimensions/Weight:

1 x 2280mm Long x 1010mm High x 90mm Deep. Estimated 34kg

2 x 330mm Long x 260mm High x 325mm Deep. Estimated 5kg

Proudly designed and made in NZ.

SLIM - STORE BED HEADBOARD + BEDSIDES – KING

MOOD

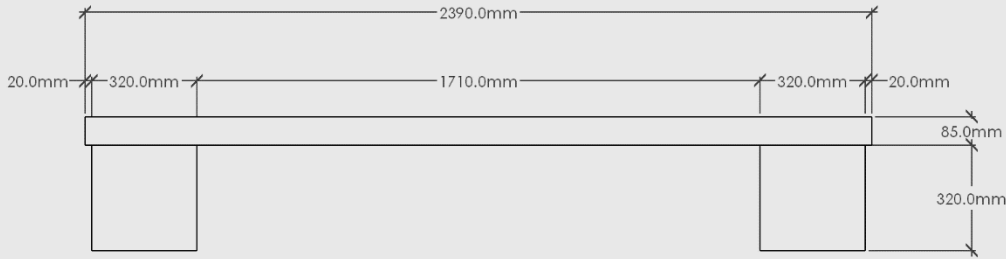

PLAN VIEW

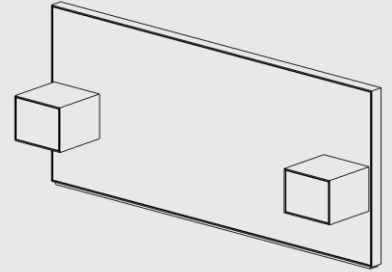

3D VIEW

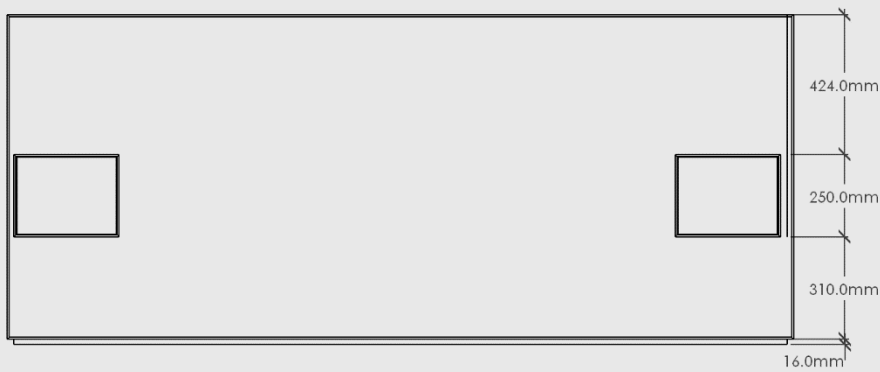

ELEVATION - FRONT

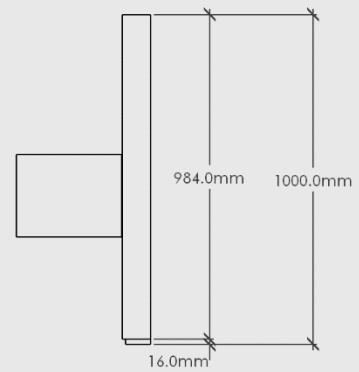

ELEVATION - SIDE

Slim - Store Bed Headboard + Bedsides - King

Dimensions: 2390mm Long x 85mm + 320mm Wide x 1000mm High

Shell/Fronts: Chosen Timber Veneer on 18mm Birch Plywood. Stained Oiled Edges to match.

Carcass: 16mm SupaBlack Carcass Grade Plywood with 1mm Black Edging

Hardware: Innobox 270mm x 86mm White Steel German Made Runners or similar.

Handle: Push to Open

Leg: N/A

Colour Options:



Oak

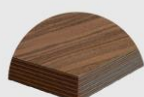

Walnut



Black Oak

Push to open handle can be disabled to add on your chosen handle.

Headboard can be mounted on wall. Cleats are provided for installation.

Package Dimensions/Weight:

1 x 2400mm Long x 1010mm High x 90mm Deep. Estimated 36kg

2 x 330mm Long x 260mm High x 325mm Deep. Estimated 5kg

Proudly designed and made in NZ.

SLIM - STORE BED HEADBOARD + BEDSIDES – SUPER KING

MOOD

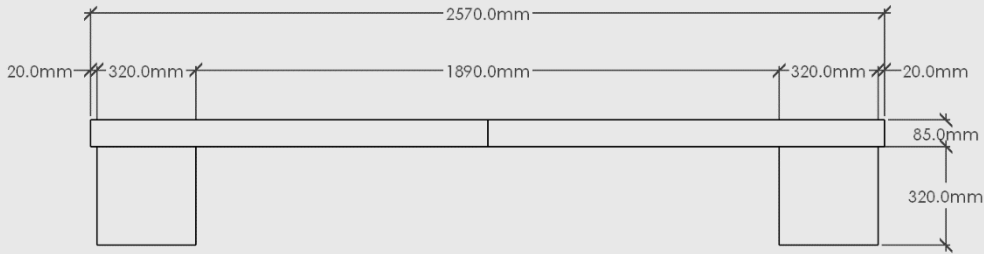

PLAN VIEW

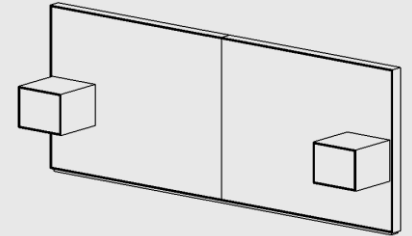

3D VIEW

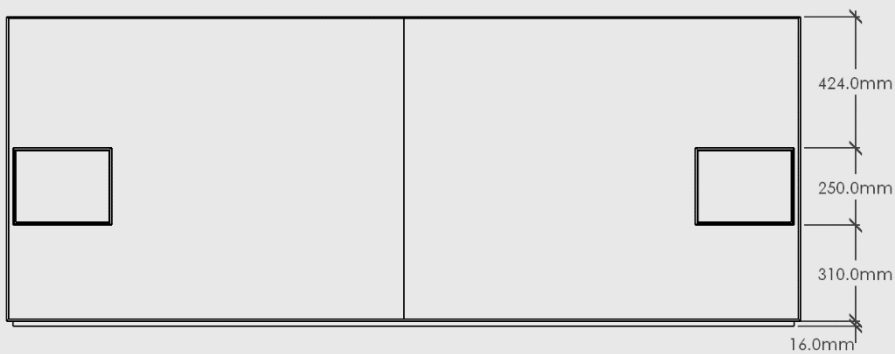

ELEVATION - FRONT

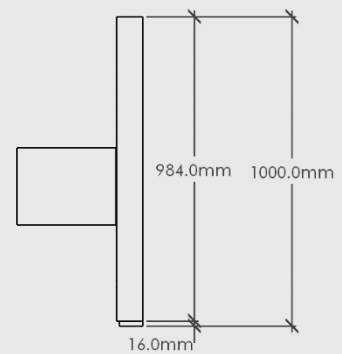

ELEVATION - SIDE

Slim - Store Bed Headboard + Bedsides – Super King

Dimensions: 2570mm Long x 85mm + 320mm Wide x 1000mm High

Shell/Fronts: Chosen Timber Veneer on 18mm Birch Plywood. Stained Oiled Edges to match.

Carcass: 16mm SupaBlack Carcass Grade Plywood with 1mm Black Edging

Hardware: Innobox 270mm x 86mm White Steel German Made Runners or similar.

Handle: Push to Open

Leg: N/A

Colour Options:

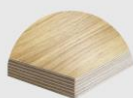

Oak



Walnut

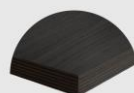

Black Oak

Push to open handle can be disabled to add on your chosen handle.

Headboard can be mounted on wall. Cleats are provided for installation.

Package Dimensions/Weight:

1 x 2580mm Long x 1010mm High x 90mm Deep. Estimated 39kg

2 x 330mm Long x 260mm High x 325mm Deep. Estimated 5kg

Proudly designed and made in NZ.