



Ultra Quiet Air Purifier



Hello!



Owner's manual

Model: SPA-780N

24/7 customer care



For Questions: Call 888.866.8862

Visit us at www.rabbitair.com

Hello there!

General Safety Information About Your MinusA2 Air Purifier

“

Meet your brand new MinusA2®!

We hope that this stylish bundle of cleanliness is just what you've been looking for. Be sure to get familiar with this newest addition to your home, by exploring all of its features in the enclosed booklet and on our website. If you have any questions just give us a call, anytime. We love to hear from you!

”

This device complies with Part 15 of the FCC Rules.

Operation is subject to the following two conditions:

(1) this device may not cause harmful interference and (2) this device must accept any interference received, including interference that may cause undesired operation.

FCC Radiation Exposure Statement

This equipment complies with FCC radiation exposure limits set forth for an uncontrolled environment. This equipment should be installed and operated with minimum distance 20cm between the radiator & your body. Any changes or modifications not expressly approved by the party responsible for compliance could void the user's authority to operate this equipment.



This product earned the ENERGY STAR label by meeting strict energy efficiency guidelines set by the U.S. EPA. Room air cleaners have demonstrated the potential for improving air quality and providing health benefits. EPA does not endorse manufacturer claims regarding the degree to which a specific product will produce healthier indoor air.

The energy efficiency of this ENERGY STAR certified model is measured based on a ratio between the model's CADR for Smoke and the electrical energy it consumes, or CADR/Watt.

Caution: When using electrical appliances, observe the following basic precautions to reduce the risk of fire, electric shock, and injury:

- Please read all tips and warnings before using your Rabbit Air® purifier.
- Use only as directed by the Owner's Manual.
- Please observe extreme caution when using the air purifier in close proximity to children.
- Rabbit Air purifiers are for indoor use only.
- The Rabbit Air purifier is not intended for use in bathrooms, laundry areas, or other damp indoor environments. Keep the Rabbit Air purifier away from water at all times.
- Do not use the Rabbit Air purifier near fireplaces or in areas where flammable or combustible products or vapors may be present.
- This appliance has a polarized plug (one blade is wider than the other). To reduce the risk of electric shock, this plug is intended to fit in a polarized outlet only one way. If the plug does not fit fully in the outlet, reverse the plug. If it still does not fit, contact a qualified electrician. Do not attempt to defeat this safety feature.
- This appliance is not intended for use by persons (including children) with reduced physical, sensory or mental capabilities, or lack of experience and knowledge, unless they have been given supervision or instruction concerning use of the appliance by a person responsible for their safety.
- Children should be supervised to ensure they do not play with the appliance.
- This product complies with the maximum allowable concentration of ozone of 0.050 parts per million by volume (ppmv) in a 24-hour period. The Health Canada Guideline 2010 recommends that the Maximum exposure limit, based on an averaging time of 8 hours, is 0.020 ppmv or less when tested in a Sealed, controlled room approximately 30 m³.

Electrical Safety Instructions

- The Rabbit Air purifier is designed for use in a 120V outlet only.
- Turn off your Rabbit Air purifier before unplugging it from the power outlet.
- Unplug the Rabbit Air purifier from the power outlet when not in use and before servicing or cleaning the unit.
- To reduce the risk of electric shock, the Rabbit Air purifier has a polarized plug, which means it will fit into a polarized outlet only one way. If the plug does not fit into the outlet, reverse the plug. If it still does not fit, contact qualified personnel to install the proper outlet. Do not alter the plug in any way.
- To avoid electric shock, do not touch the air purifier or its power plug with wet hands.
- Keep the electrical cord away from heated surfaces at all times.
- If the cord or plug appears damaged, return the unit immediately to an authorized service facility for examination and repair.
- Any attempts to repair the Rabbit Air purifier without written permission from Rabbit Air will void the warranty and could cause serious personal injury to the user and/or result in severe damage to the unit.
- Do not pull, carry, lift, or drag the Rabbit Air purifier by pulling its power cord. Remove the power plug from its outlet by grasping the plug and pulling gently.
- When the Rabbit Air purifier is plugged into a power outlet, keep all fingers, body parts, hair, jewelry, and loose clothing away from the openings.

Installation Guidelines

- Avoid putting the Rabbit Air purifier in a place where the air intake or air outlet could become clogged with dirt.
- Leave at least two feet of space between the air purifier's intake, outlet, and the wall.

Operation Guidelines

- Do not block the air intake or air outlet.
- Do not use the Rabbit Air purifier on or around hot surfaces.
- Do not use the Rabbit Air purifier in a room where it may come into contact with steam.
- Do not operate the Rabbit Air purifier on its side.
- Do not install the Rabbit Air purifier in greasy or damp environments.
- Do not use detergent or soap to clean the Rabbit Air purifier.
- Do not operate the Rabbit Air purifier without filters.
- Do not wash and reuse the filters except for the washable Pre-Filter.
- When transporting the Rabbit Air purifier, always hold the handle on the back of the unit.



A childproof feature pauses air purifier operation when the front panel is removed.

Remote Control Tips



WARNING: Chemical Burn Hazard. Keep batteries away from children.

- This product contains a lithium button/coin cell battery. If a new or used lithium button/coin cell battery is swallowed or enters the body, it can cause severe internal burns and can lead to death in as little as 2 hours.
- Always completely secure the battery compartment. If the battery compartment does not close securely, stop using the product, remove the batteries, and keep it away from children.
- If you think batteries might have been swallowed or placed inside any part of the body, seek immediate medical attention.
- The cells shall be disposed of properly, including keeping them away from children.
- Even used cells may cause injury.
- Inverter lighting equipment or electronic light fixtures may interfere with remote control signals.
- Avoid storing the remote control in direct sunlight. Heat may interfere with remote control signals.

Meet your MinusA2

Front view

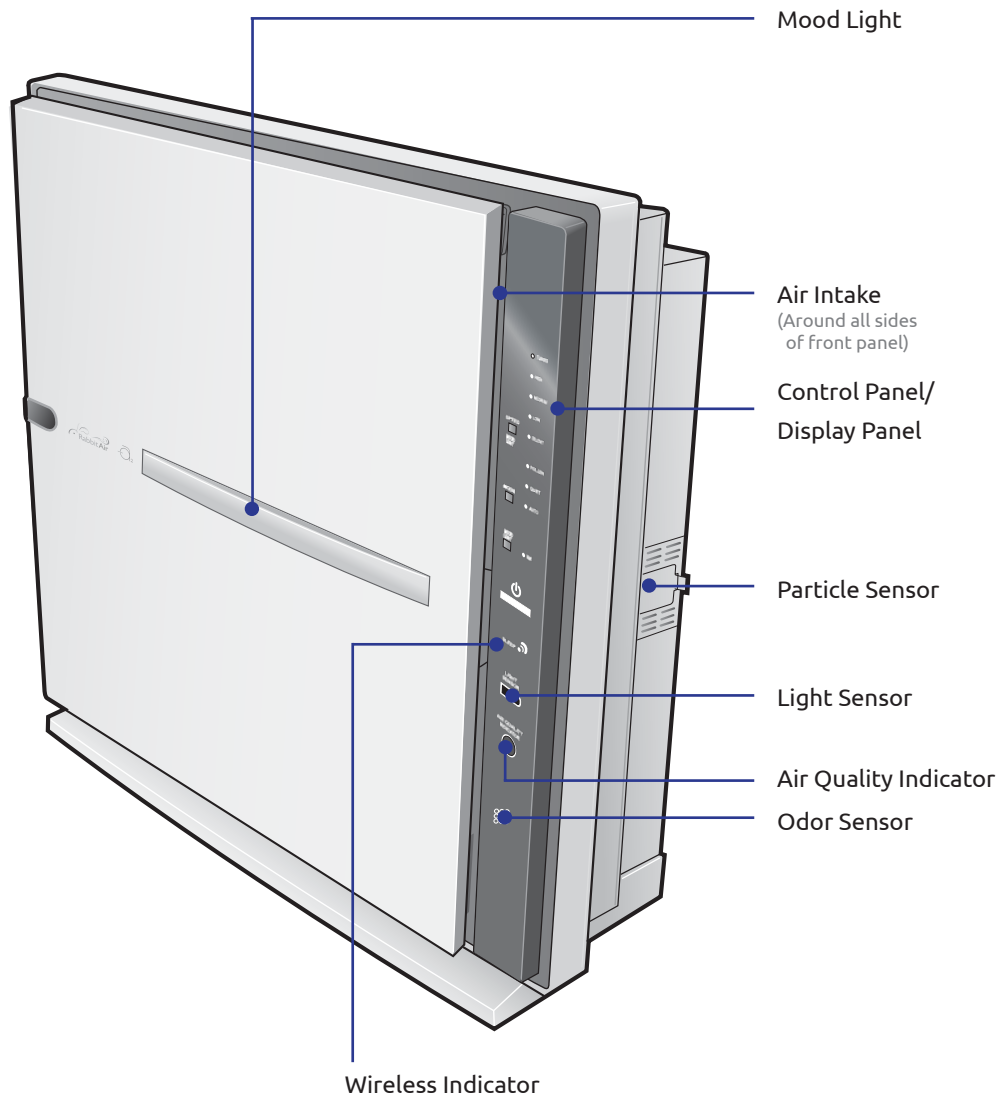

Back view

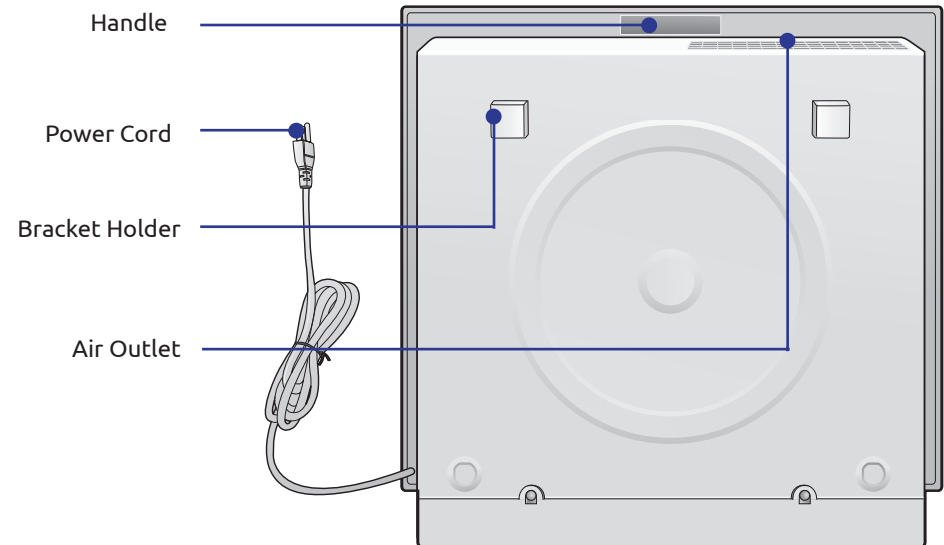

Remote control

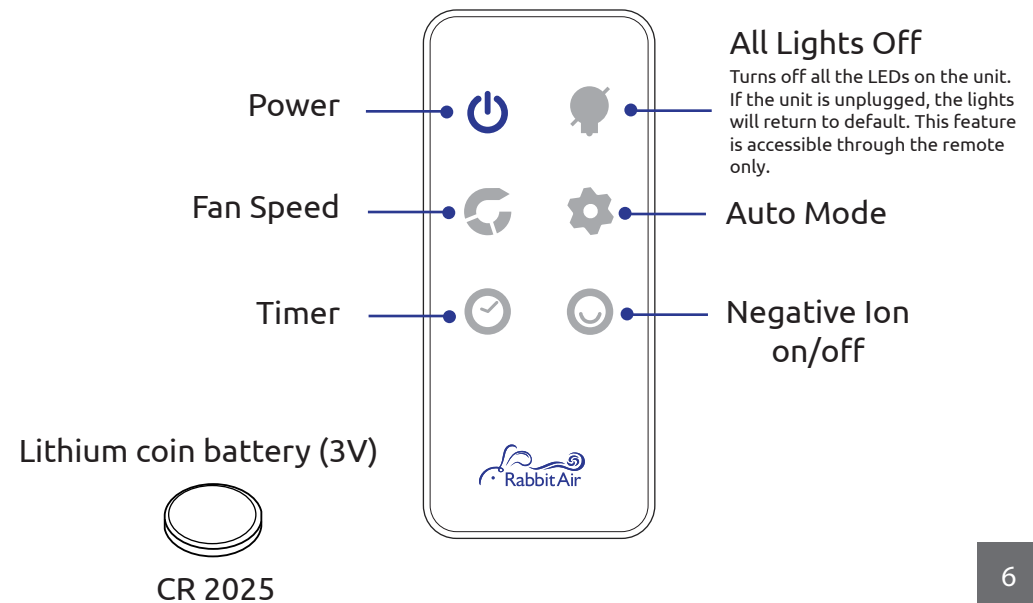

Meet the Filters

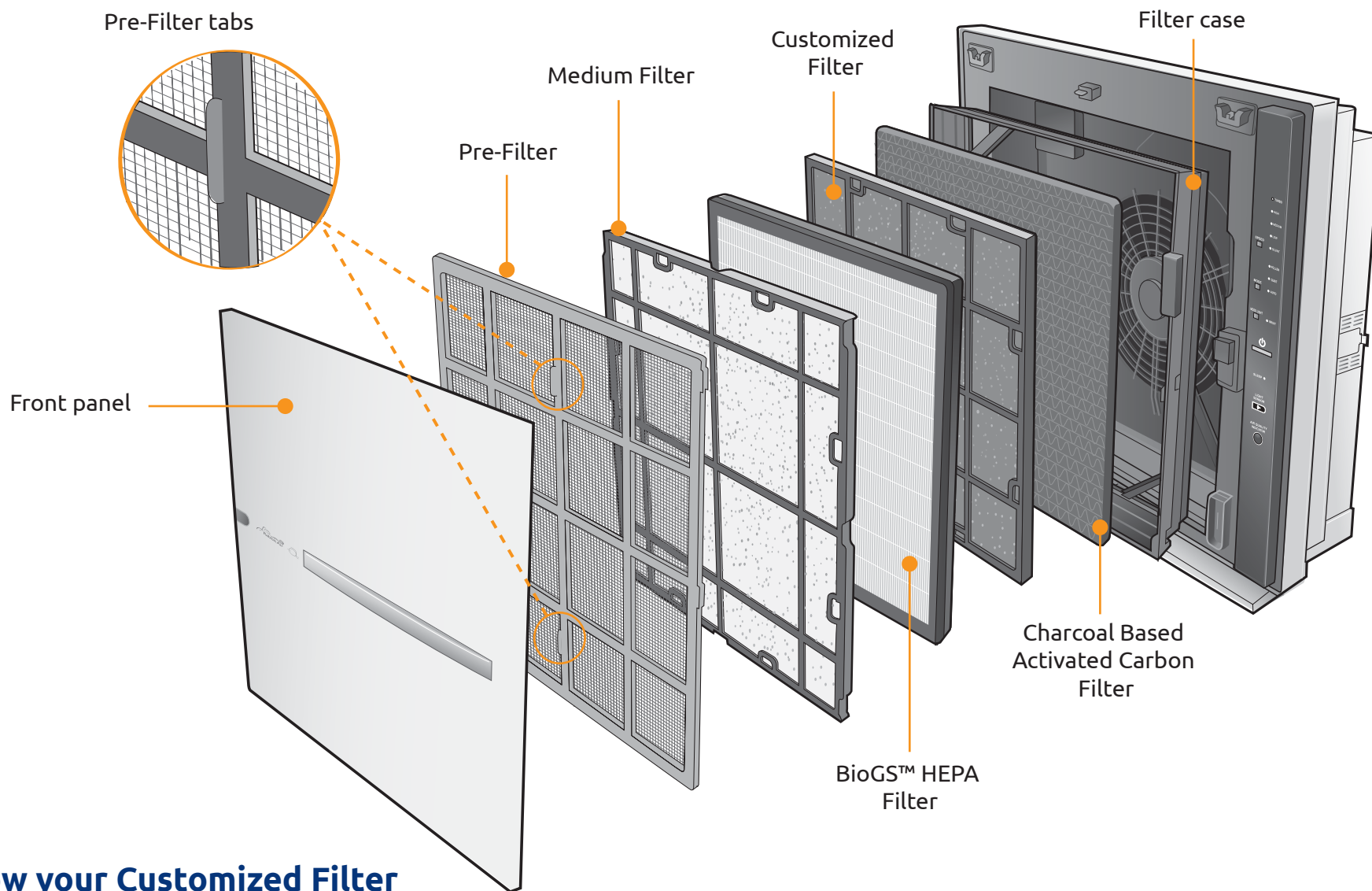

Know your Customized Filter

Toxin Absorber Customized Filter:
 Front color: Purple
 Back color: Gray

Germ Defense Customized Filter:
 Front color: Purple & Yellow
 Back color: Yellow

Pet Allergy Customized Filter:
 Front color: Purple & Rose
 Back color: Rose

Odor Remover Customized Filter:
 Front color: Black (coated material)
 Back color: Black

Control Panel / Operation Modes

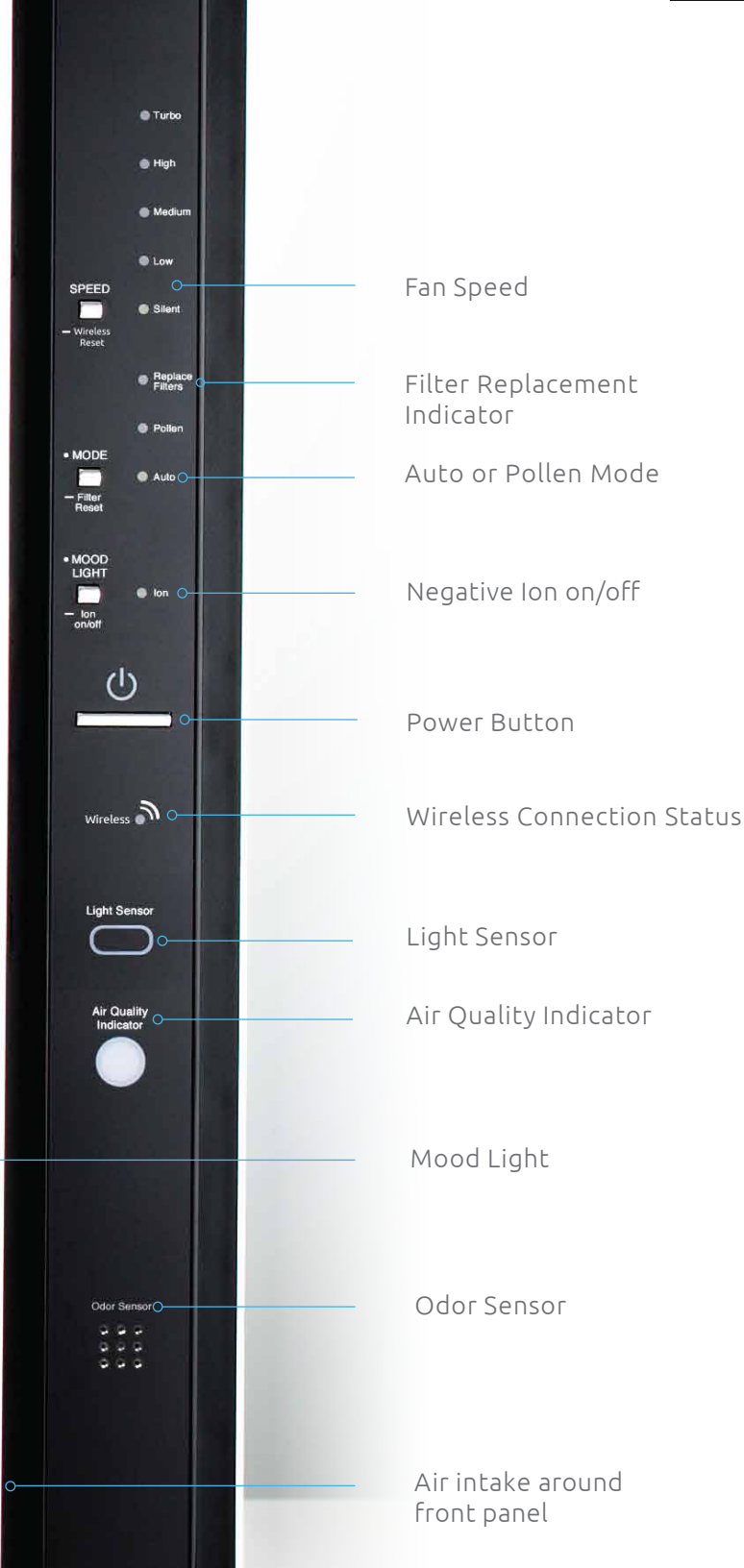

Fan Speed

Filter Replacement Indicator

Auto or Pollen Mode

Negative Ion on/off

Power Button

Wireless Connection Status

Light Sensor

Air Quality Indicator

Mood Light

Odor Sensor

Air intake around front panel

Speed and Wireless Reset



• Short Press:

Changes to a manual fan speed. The manual fan speed changes in the following order as you press this button:
Silent - Low - Medium - High - Turbo.

- Turbo
- High
- Medium
- Low
- Silent

– Press and Hold:

Initiates or resets wireless setting to connect air purifier to a 2.4 GHz wireless network using a mobile device. Please download the Rabbit Air App from the Apple Store (iOS) or Google Play Store (Android) to your device and follow instruction for setup.



The Wireless Indicator will flash during setup and remain illuminated once it is connected to the network. See page 12 for more info.

Mode and Filter Reset

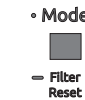

• Short Press:

Changes the mode of operation to Auto Mode or Pollen Mode.

Pollen Mode: Fan speed will adjust according to the air quality detected. The color of the Mood Light will slowly cycle from blue - purple - light purple - pink.

- Pollen

Auto Mode: Fan speed will adjust according to the air quality detected unless air purifier is in Sleep Lighting. While the air purifier is in Sleep Lighting, the fan speed will remain in Silent Speed. The Mood Light will be solid blue.

- Auto

– Press and Hold:

Resets Filter Replacement Indicator. The Replace Filters Indicator will illuminate when it is time to change your filters. Once you have replaced the filters, press and hold the button until the Replace Filters Indicator turns off.

- Replace Filters

Mood Light and Ion on/off

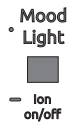

• Short Press:

Turns the Mood Light on or off. The color of the Mood Light corresponds to the current mode of operation.

Manual Speed: Blue

Auto Mode: Blue

Pollen Mode: Mood Light cycles from blue - purple - light purple - pink

– Press and Hold:



Turns the Negative Ion Generator on or off.

Light Sensor (Sleep Lighting)

Light Sensor



The Light Sensor will detect if the room is dark and activate Sleep Lighting after three minutes of darkness.

While the air purifier is operating in Sleep Lighting, the Mood Light and Air Quality Indicator will be turned off. If the unit was operating in Auto Mode, the fan speed of the air purifier will automatically adjust to Silent Speed, minimizing energy consumption and noise.

Sleep Lighting will not override the fan speed if the MinusA2 was operating in one of its Manual Speed or Pollen Mode.

Air Quality Indicator

Air Quality



This light indicates the current air quality in the room as detected by the Odor Sensor and Particle Sensor. The color will shift from blue (good) - purple - light purple - red (poor), depending on the amount of contaminants detected.

Operation Tips

The MinusA2 can be used for various air quality improvement reasons. For recommendation on the right speed and mode for you, please contact our knowledgeable Customer Care Team at 888.866.8862

Connecting with your smart phone or tablet

Requires iOS or Android device and a 2.4Ghz WiFi network



1. Download the Rabbit Air app to your smart phone or tablet.
2. Use your existing customer login or create a new account.
3. Select "Setup new purifier" or "Find existing purifier" and follow the steps on the screen.
4. Now you can monitor your air quality and control your air purifier remotely. For more information, contact us at www.rabbitair.com/wireless.

Changing the Sensitivity Level of the Sensors

You can adjust the sensitivity level of the air quality sensors. The sensors come preset at a standard sensitivity level as a default.

1. Press and hold both the Speed and Mode button for three seconds.

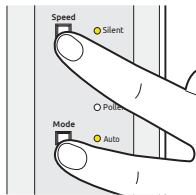

2. The Air Quality Indicator and Auto Mode Indicator will blink.

3. Press the Speed button to choose the sensitivity level.

Replace Filters : Low sensitivity
Pollen Mode : Standard sensitivity
Auto Mode : High sensitivity

- Replace Filters → Low
- Pollen → Standard
- Auto → High

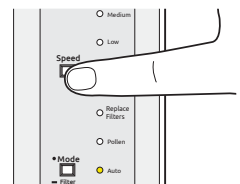

4. Press and hold the Speed and Mode buttons for three seconds to save the sensitivity level. If no action is taken for ten seconds, the sensitivity level you last selected is saved automatically.

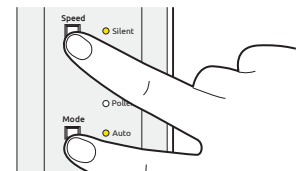

Cleaning and Maintenance

Always unplug the unit before cleaning.

Cleaning the MinusA2

Use a damp cloth to remove stubborn stains and dirty buildup if necessary. Avoid commercial cleaning products.

1. Use a clean, dry cloth to wipe the external surfaces of the air purifier. The unit surface should be cleaned depending on the air quality of the room.



2. Clean the air intake and outlet with a soft brush.

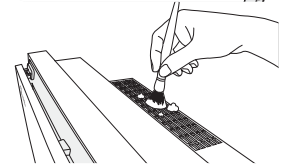

3. Remove the front panel from the unit and use a dry cloth or soft brush to dust it off.

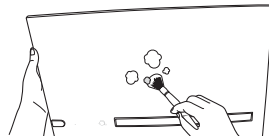

4. Use a dry cloth, soft brush, or cotton swab to dust off the Mood Light lens on the back of the panel.

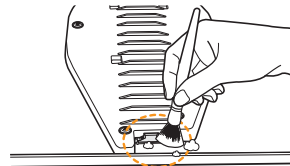

Cleaning the Particle Sensor

Clean particle sensor every three to six months. Clean the air inlet and outlet using a vacuum cleaner or soft brush.

1. Open the particle sensor cover on the right side of the unit (when facing the unit).
2. Use a damp cotton swab to clean and dry the lens, dust inlet and dust outlet.

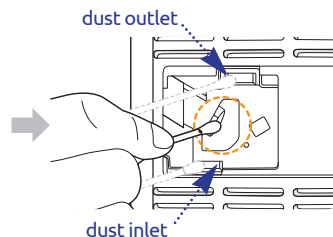
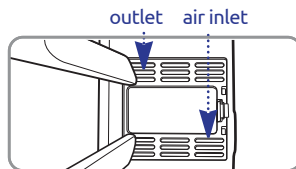
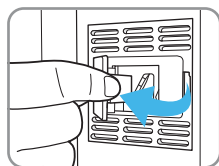

Cleaning the Pre-filter

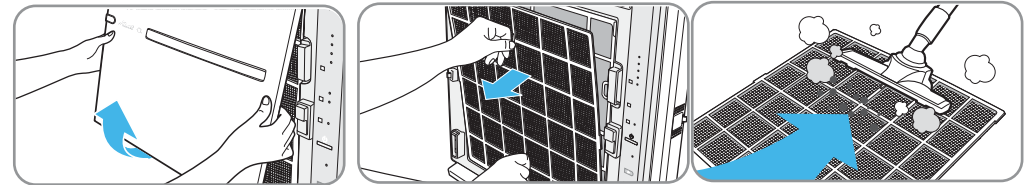

The Pre-Filter should be cleaned depending on the air quality of the room.

• Vacuum method:

1. Remove front panel from the air purifier.
2. Run a vacuum cleaner with a nozzle or brush attachment on low power setting along the Pre-Filter to remove visible particles.

If vacuuming does not seem to sufficiently clean your Pre-Filter, please follow the steps below to wash it.

• Washing method:

1. Remove the Pre-Filter from the unit.
2. Fill the sink with lukewarm water and gently wash the Pre-Filter under the water for 2-3 minutes or until it is completely clean.
3. Rinse the Pre-Filter with clean tap water.
4. Use a towel to remove any excess water from the Pre-Filter.
5. Allow the Pre-Filter to dry for 12-24 hours.
6. When the Pre-Filter is completely dry, place back into the air purifier.

Filter Cleaning and Replacement Schedule*

Filters	Filter Life	Cleaning
Pre-Filter	Washable	Every Month
Medium	Every 12 Months	Not Required
BioGS HEPA	Every 12 Months	Not Required
Customized	Every 12 Months	Not Required
Charcoal-based Activated Carbon	Every 12 Months	Not Required

*Based on 24/7 operation

Replacing your Filters

Always unplug the unit before cleaning/replacing the filters.
Depending on the amount of pollutants in your indoor environment, the life span of the filters will vary.

Pre-filter

Do NOT discard the Pre-Filter. It is designed to be cleaned and reused.

The Pre-Filter does not need to be replaced.

1. Pull the tabs on the front of the Pre-Filter to remove it.
2. Put the Pre-Filter to one side while replacing the other filters.

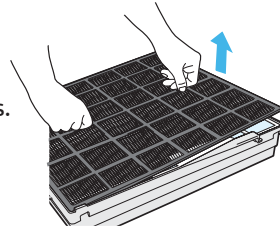

Replacing the Medium Filter *every 12 months*

Do NOT discard the filter frame. Discard the old Medium Filter, do not reuse.

1. Remove the old Medium Filter from the black frame and discard the expired filter.
2. Open new Medium Filter and discard the plastic wrapping.
3. Secure the new filter in the black frame.

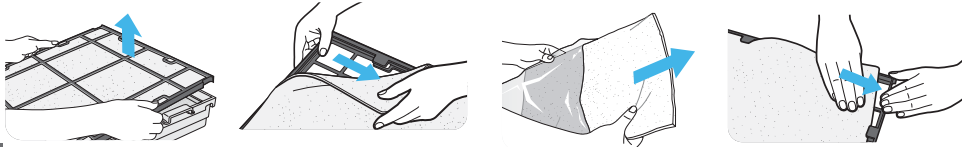

Replacing the BioGS HEPA Filter *every 12 months*

Discard the old HEPA Filter, do not reuse.

1. Remove old HEPA Filter and discard.
2. Remove new filter from plastic wrapping.
3. Place new HEPA Filter in filter case.

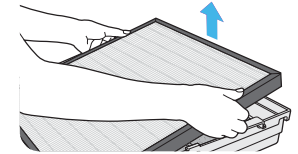

Replacing the Customized Filter *every 12 months*

Do NOT discard the filter holder. Discard the old Customized Filter, do not reuse.

1. Remove the old Customized Filter from the black frame and discard expired filter.
2. Take the new Customized Filter out of the plastic wrapping and place in the black frame.
3. Make sure the front of the Customized Filter is facing up. See Customized Filter chart, (page 7-8), to identify the front of your specific filter.

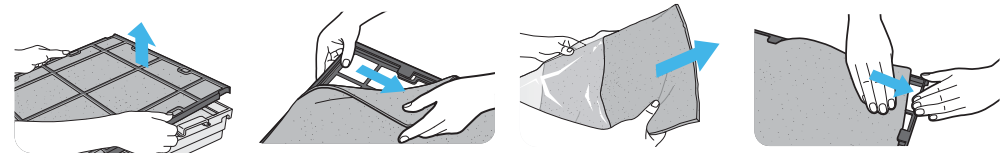

Replacing the Activated Carbon Filter *every 12 months*

Discard the old Activated Carbon Filter, do not reuse.

1. Pull out the old Activated Carbon Filter and discard.
2. Remove the new Activated Carbon Filter from its plastic wrapping, and place in the filter case.

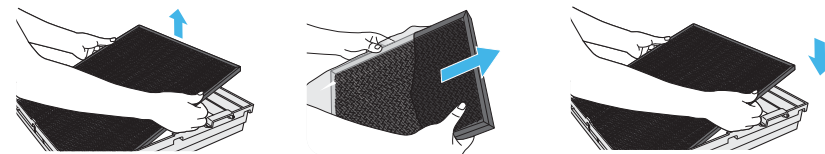

Return the filters to the filter case in the following order from back to front:

- Activated Carbon Filter,
- Customized Filter,
- BioGS HEPA Filter,
- Medium Filter,
- Pre-Filter.

(See diagram on page 7-8).

Wall-Mounting your MinusA2

(Optional)



Warranty

Register online at www.rabbitair.com/warranty

Only use the approved Rabbit Air wall-mount kit to install the MinusA2 Air Purifier on your wall. The MinusA2 Air Purifier is designed to be either free standing or wall-mounted.

Wall-mount installation guidelines:

- Make sure the MinusA2 Air Purifier has at least two feet of clearance from the ceiling and eight inches of clearance on either side.
- Be careful not to drop the front panel or filter case when replacing the filters.
- Do not pull on the power cord.
- Make sure the hanger screws have been securely driven into studs.

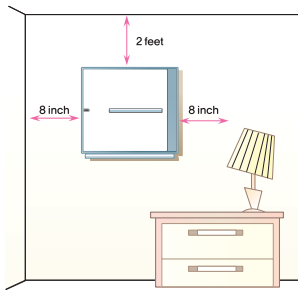

Questions? Reach us at www.rabbitair.com or 888.866.8862

Disclaimer for installing wall-mounted objects

Do not attempt to install this product if you do not understand the instructions. Contact a qualified contractor to install the mounting bracket and call 1-888-866-8862 if you have any questions. You risk the possibility of damaging the Air Purifier, damaging other property and personal injury if the mounting bracket is not installed properly. Check to make sure there are no missing or defective parts. Do not attempt to install the mounting bracket if there are missing or defective parts. Contact Rabbit Air and replacement parts will be shipped to you immediately. Rabbit Air is not liable for damage or injury caused by incorrect mounting, incorrect assembly or incorrect usage.

- After installing the wall-mount bracket, make sure it is firmly in place before putting the MinusA2 Air Purifier on it.
- Take care not to drill or screw into existing wiring in the wall while installing the wall-mount bracket.

Correct installation is extremely essential, and falls outside the scope of responsibility of Rabbit Air. Please consult a qualified contractor and/or specialist supplier to install the mounting bracket. Maximum weight of air purifier SPA-780N / SPA-700A: 8.8 kg/ 19.4 lbs.

Register your air purifier online now for:

- **Product Protection**
By registering your product and purchase information, we can confirm the date of purchase to secure your warranty. This confirmation serves as security in the event that your original proof of purchase is lost, or in case your unit needs any servicing in the future.
- **Proof of Ownership**
Your model number, serial number, and other information will be kept in our files. Please complete and return this registration within 90 days from purchase in order to receive our 5-year limited warranty.

Where you can find us

Pasadena - Office

125 N. Raymond Ave.
Suite 308
Pasadena, CA 91103

Japan - Office

East Court 2, 1-14-202,
Koyochonaka, Higashinada-ku,
Kobe, 658-0032 Japan

Downey - Office & Service Center

9242 1/2 Hall Rd.
Downey, CA 90241

24/7 customer care



For Questions: Call 888.866.8862
Visit us at www.rabbitair.com

Limited Warranty

Rabbit Air
Five (5) Year Limited Warranty
(For Rabbit Air Branded Products Only)

IMPORTANT: BY USING the BioGS 2.0 OR MinusA2 air purifiers (each, a "Rabbit Air Product") YOU ARE AGREEING TO BE BOUND BY THE TERMS OF THE RABBIT AIR FIVE (5) YEAR LIMITED WARRANTY ("WARRANTY") AS SET OUT BELOW. AS NOTED IN THE "YOUR RESPONSIBILITIES" SECTION BELOW, RABBIT AIR RESERVES THE RIGHT NOT TO HONOR THIS WARRANTY IF IT HAS NOT BEEN REGISTERED WITHIN NINETY (90) DAYS OF YOUR PURCHASE OF THE RABBIT AIR PRODUCT. THIS WARRANTY APPLIES REGARDLESS OF WHETHER YOU PURCHASE A RABBIT AIR PRODUCT FROM A RABBIT AIR AUTHORIZED RESELLER OR DIRECTLY FROM RABBIT AIR.

DO NOT USE YOUR RABBIT AIR PRODUCT UNTIL YOU HAVE READ THE TERMS OF THE WARRANTY. IF YOU DO NOT AGREE TO THE TERMS OF THE WARRANTY, DO NOT USE THE RABBIT AIR PRODUCT AND RETURN IT WITHIN THE RETURN PERIOD STATED IN RABBIT AIR'S RETURN POLICY (FOUND AT <https://www.rabbitair.com/pages/why-rabbit-air#money-back>) TO RABBIT AIR OR TO THE AUTHORIZED RESELLER WHERE YOU PURCHASED IT FOR A REFUND. This limited warranty does not cover replacement filters, FILTER FRAMES, FILTER CASES, OR WALL MOUNT BRACKETS.

HOW CONSUMER LAW RELATES TO THIS WARRANTY

THIS WARRANTY GIVES YOU SPECIFIC LEGAL RIGHTS, AND YOU MAY HAVE OTHER RIGHTS THAT VARY FROM STATE TO STATE (OR BY COUNTRY OR PROVINCE). OTHER THAN AS PERMITTED BY LAW, RABBIT AIR DOES NOT EXCLUDE, LIMIT, OR SUSPEND OTHER RIGHTS YOU MAY HAVE, INCLUDING THOSE THAT MAY ARISE FROM THE NONCONFORMITY OF A SALES CONTRACT. FOR A FULL UNDERSTANDING OF YOUR RIGHTS YOU SHOULD CONSULT THE LAWS OF YOUR COUNTRY, PROVINCE, OR STATE.

WARRANTY LIMITATIONS SUBJECT TO CONSUMER LAW

TO THE EXTENT PERMITTED BY LAW, THIS WARRANTY AND THE REMEDIES SET FORTH ARE EXCLUSIVE AND IN LIEU OF ALL OTHER WARRANTIES, REMEDIES, AND CONDITIONS, WHETHER ORAL, WRITTEN, STATUTORY, EXPRESS, OR IMPLIED. LIKEWISE, TO THE EXTENT PERMITTED BY LAW, RABBIT AIR DISCLAIMS ALL STATUTORY AND IMPLIED WARRANTIES, INCLUDING WITHOUT LIMITATION WARRANTIES OF MERCHANTABILITY AND FITNESS FOR A PARTICULAR PURPOSE AND WARRANTIES AGAINST HIDDEN OR LATENT DEFECTS. INsofar AS SUCH WARRANTIES CANNOT BE DISCLAIMED, RABBIT AIR LIMITS THE DURATION AND REMEDIES OF SUCH WARRANTIES TO THE DURATION OF THIS EXPRESS WARRANTY AND, AT RABBIT AIR'S OPTION, THE REPAIR OR REPLACEMENT SERVICES DESCRIBED BELOW. SOME STATES (OR COUNTRIES AND PROVINCES) DO NOT ALLOW LIMITATIONS ON HOW LONG AN IMPLIED WARRANTY (OR CONDITION) MAY LAST, SO THE LIMITATION DESCRIBED ABOVE MAY NOT APPLY TO YOU.

WHAT IS COVERED BY THIS WARRANTY?

Kinetic Solutions, Inc., d/b/a "Rabbit Air", located at 125 N Raymond Ave, Suite 308, Pasadena, CA 91103 ("Rabbit Air"), warrants Rabbit Air Products contained in the original packaging against defects in materials and workmanship when used normally in accordance with Rabbit Air's published guidelines for a period of FIVE (5) YEARS from the date of original retail purchase by the end-user purchaser ("Warranty Period"). Rabbit Air's published guidelines include, but are not limited to, information contained in technical specifications, user manuals, and service communications.

WHAT IS NOT COVERED BY THIS WARRANTY?

This Warranty does not apply to any non-Rabbit Air branded hardware products, even if packaged or sold with Rabbit Air hardware. Manufacturers, suppliers, or publishers, other than Rabbit Air, may provide their own warranties to you. Please contact them for further information. Rabbit Air does not warrant that the operation of the Rabbit Air Product will be uninterrupted or error-free. Rabbit Air is not responsible for damage arising from failure to follow instructions relating to the Rabbit Air Product's use.

Additionally, this Warranty does not apply: (a) to replacement filters, filter frames, filter cases, or wall mount brackets; (b) to consumable parts, such as batteries or protective coatings, that are designed to diminish over time, unless failure has occurred due to a defect in materials or workmanship; (c) to cosmetic damage, including, but not limited to, scratches, dents, and broken plastic, unless such damage has occurred due to a defect in materials or workmanship; (d) to damage caused by use with a third party component or product, including without limitation any replacement air filters not manufactured by Rabbit Air; (e) to damage caused by breakdowns, fluctuations, or interruptions in electric power or by connection to improper power supply; (f) to damage caused by accident, abuse, misuse, fire, liquid contact, earthquake, or other external force; (g) to damage caused by operating the Rabbit Air Product outside Rabbit Air's published guidelines; (h) to damage caused by service performed by anyone who is not a representative of Rabbit Air; (i) to a Rabbit Air Product that has been modified to alter functionality or capability without the written permission of Rabbit Air; (j) to defects caused by normal wear and tear or otherwise due to the normal aging of the Rabbit Air Product; (k) to Rabbit Air Products marked as "sample" or sold "as is"; (l) if any serial number has been removed or defaced from the Rabbit Air Product; or (m) if Rabbit Air receives information from relevant public authorities that a Rabbit Air Product has been stolen.

YOUR RESPONSIBILITIES

Rabbit Air tries to honor this warranty in all cases where it has information regarding your purchase; however, Rabbit Air reserves the right not to honor this warranty if it has not been registered within ninety (90) days of your purchase of the Rabbit Air Product. Accordingly, we encourage you to complete the warranty registration form online at www.rabbitair.com/warranty. This warranty extends only to the original purchasers who acquire new products from Rabbit Air or its authorized resellers, or to anyone who receives a Rabbit Air Product as a gift, provided we are able to verify who made the purchase. Before receiving warranty service, Rabbit Air or its agents may require that you furnish proof of purchase details, respond to questions designed to assist with diagnosing potential issues, and follow Rabbit Air's procedures for obtaining warranty service.

WARRANTY SERVICE DURING THE FIRST 90 DAYS

To submit a claim under this warranty, please contact Rabbit Air at 1-888-866-8862 or by e-mail at CustomerService@rabbitair.com. When contacting Rabbit Air via telephone, other charges may apply depending on your location.

If you submit a valid claim to Rabbit Air in accordance with this warranty within ninety (90) days of your purchase of a Rabbit Air Product, Rabbit Air will replace the Rabbit Air Product with the same model (or with your consent a Rabbit Air Product that has similar functionality). For warranty claims within the first ninety (90) days, Rabbit Air offers free shipping both ways within the forty-eight (48) contiguous United States, and free shipping one way to Canada, Hawaii, Alaska, Puerto Rico, Guam, the Virgin Islands, and APO, FPO or DPO addresses (you pay for shipping to Rabbit Air, and we pay for shipping the replacement back to you).

WARRANTY SERVICE AFTER THE FIRST 90 DAYS

If you submit a valid claim to Rabbit Air in accordance with this warranty after ninety (90) days, but during the Warranty Period, Rabbit Air's obligation and liability under this limited warranty is limited to repairing (or, at the sole discretion of Rabbit Air, replacing) the Rabbit Air Product, if in need of repair or deemed defective. When a Rabbit Air Product or part is replaced, any replacement item becomes your property and the replaced or refunded item becomes Rabbit Air's property.

To obtain service under this warranty, please contact Rabbit Air at the phone number or e-mail listed above. A Rabbit Air representative will help determine whether your Rabbit Air Product requires service or needs replacing and, if it does, will inform you how Rabbit Air will provide such service or replacement. In such cases, Rabbit Air may, at its sole discretion, offer free shipping both ways within the forty-eight (48) contiguous United States, or free shipping one way to Canada, Hawaii, and Alaska (you pay for shipping to Rabbit Air, and we pay for shipping the repaired or replaced product back to you).

Please note that any repairs attempted or completed without Rabbit Air authorization will void this warranty.

Rabbit Air reserves the right to change the method by which Rabbit Air may provide warranty service to you, and your Rabbit Air Product's eligibility to receive a particular method of service. Service will be limited to the options available in the country where service is requested. Service options, parts availability, and response times may vary according to country. If you seek service in a country that is not the original country of purchase, you will comply with all applicable import and export laws and regulations and be responsible for all custom duties, V.A.T. and other associated taxes and charges.

LIMITATION OF LIABILITY

EXCEPT AS PROVIDED IN THIS WARRANTY AND TO THE MAXIMUM EXTENT PERMITTED BY LAW, RABBIT AIR IS NOT RESPONSIBLE FOR INDIRECT, SPECIAL, INCIDENTAL, OR CONSEQUENTIAL DAMAGES RESULTING FROM THE USE OF ANY RABBIT AIR PRODUCT OR ANY BREACH OF WARRANTY OR CONDITION, UNDER ANY LEGAL THEORY, INCLUDING BUT NOT LIMITED TO LOSS OF USE; LOSS OF REVENUE; LOSS OF ACTUAL OR ANTICIPATED PROFITS (INCLUDING LOSS OF PROFITS ON CONTRACTS); LOSS OF THE USE OF MONEY; LOSS OF ANTICIPATED SAVINGS; LOSS OF BUSINESS; LOSS OF OPPORTUNITY; LOSS OF GOODWILL; OR LOSS OF REPUTATION.

THE FOREGOING LIMITATION SHALL NOT APPLY TO DEATH OR PERSONAL INJURY CLAIMS, OR ANY STATUTORY LIABILITY FOR INTENTIONAL AND GROSS NEGLIGENT ACTS AND/OR OMISSIONS.

SOME STATES (COUNTRIES AND PROVINCES) DO NOT ALLOW THE EXCLUSION OR LIMITATION OF INCIDENTAL OR CONSEQUENTIAL DAMAGES, SO THE ABOVE LIMITATION OR EXCLUSION MAY NOT APPLY TO YOU.

GENERAL

No Rabbit Air reseller, agent, or employee is authorized to make any modification, extension, or addition to this Warranty. If any term is held to be illegal or unenforceable, the legality or enforceability of the remaining terms shall not be affected or impaired. This Warranty is governed by and construed under the laws of the State of California, and you hereby consent to the exclusive jurisdiction of the state courts in Los Angeles County, California. Rabbit Air or its successor in title is the warrantor under this Warranty. Any future claims regarding your Rabbit Air Product are governed by this Warranty. However, Rabbit Air reserves the right, as a general matter, to change its warranty policies. If you make any future purchases of Rabbit Air Products, those products may be governed by different warranty policies.

ADDITIONAL INFORMATION

Visit www.rabbitair.com to learn more, or speak with a Rabbit Air Consultant at 1-888-866-8862, 24 hours a day.