

SINK DETAIL

Flow Rate: 10.27sec/gal

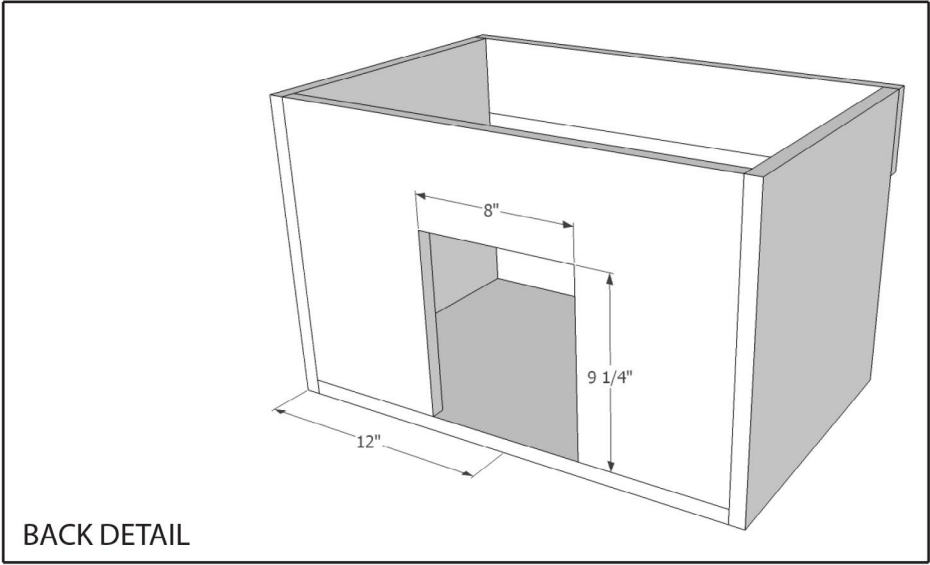

BACK DETAIL