



PRO-CLEAR™ UV

Dual Outlet UV Clarifier

Instructions for Operation • Safety • Warranty

Thank you for purchasing the Pro-Clear™ UV Clarifier. Used with care, this product can provide years of service. Ultraviolet light is a wavelength of light that inhibits algae growth from reproducing. Ultraviolet light is not designed to kill string algae. Please read this instruction booklet carefully before use to assure that you safely and correctly use this product.



PART #	DESCRIPTION	MAXIMUM FLOW	MAXIMUM POND SIZE*	QTY / SIZE BULB	CORD LENGTH	INLET/OUTLET SIZES
PC18W	18 Watt UV Transformer	2100 GPH	4000 Gallons	1 / 18 Watt	6'	0.75" / 1" / 1.25" / 1.5"
PC36W	38 Watt UV Transformer	3900 GPH	7000 Gallons	1 / 36 Watt	6'	0.75" / 1" / 1.25" / 1.5"

*Fish load, filtration capacity and other factors affect actual maximum pond size

Safety & Warnings

1. Be sure to read and follow ALL safety instructions.
2. Always disconnect the electrical supply before handling, maintaining, repairing or installing any pond equipment. Do NOT immerse or attempt to use a wet plug.
- 3. DANGER: Direct exposure to ultraviolet (UV) light can damage eyes and skin.**
 Do NOT attempt to view the lamp when lit, except through the sight glass viewer on the end of the unit.
4. ONLY connect this product to a receptacle protected by a Ground Fault Circuit Interrupter (GFCI).
5. Do NOT use if power cord is damaged. Damaged cords should be repaired or replaced.
6. All electrical work must be performed by a qualified technician. Always follow the National Electrical Code (NEC) or the Canadian Electrical Code (CEC) as well as all local, state and provincial codes. Code questions should be directed to your local electrical inspector. Failure to follow electrical codes and OSHA safety standards may result in personal injury or equipment damage. Failure to follow the manufacturer's installation instructions may result in electrical shock, fire hazard, personal injury or death, damaged equipment, provide unsatisfactory performance and may void manufacturer's warranty.

Unpacking & Installation



WARNING: Disconnect the unit from power source before performing any maintenance or installation on the unit.

CAUTION: Do not install unit on the ground where water may puddle. Do not submerge the UV unit.

1. Before unpacking the UV unit, visually check to see that the product is not damaged in the packaging.
2. The UV bulb and quartz sleeve are already installed in the unit.
3. Carefully remove the UV unit from the package. **(FIGURE 1)**
4. Open the parts bag that contains the rubber gaskets (sealing rings), plastic nuts and barbed connectors. **(FIGURE 2)**
5. Size your tubing **(FIGURE 3)** and precut your barbed connectors (fittings) before installing onto unit. Do not attach tubing to the connectors at this time.
6. Making sure that the rubber gaskets are installed in the nuts, attach the barbed connectors to the main unit. **(FIGURE 4)**
7. On a secure platform, the UV unit can be installed horizontally or vertically on its mounting brackets. Attach the tubing to the connectors.
8. Connect the power to the UV light and the water pump. Making sure the pump is running, ensure bulb is operational by looking into the sight glass on the end of the unit. This provides a safe way to see if the light is on. **(FIGURE 5)**

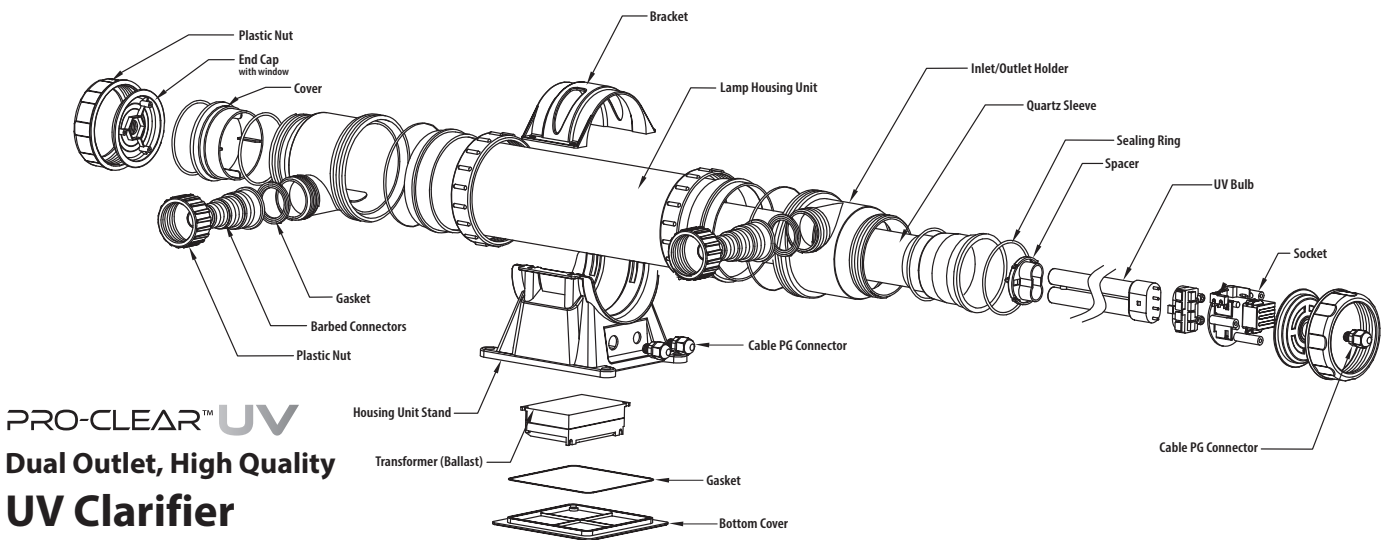
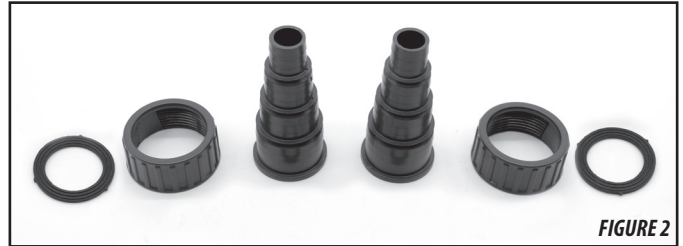

PRO-CLEAR™ UV
Dual Outlet, High Quality
UV Clarifier

UV Installation & Maintenance



WARNING: Disconnect the unit from power source before performing any maintenance or installation on the unit.

CAUTION: Do NOT operate or handle the UV bulb outside of the housing.

Ultraviolet radiation is harmful to eyes and skin and can cause serious injury.

Note: UV bulb and quartz sleeve should be handled carefully. These parts are not warranted for breakage or damage. For servicing bulbs or sleeves, after previous use, be sure to drain water from the UV housing.

Replacing the UV Bulb

1. Unscrew threaded cap from unit. (FIGURE 6)
2. Slide UV bulb partially out of the unit. Disconnect the socket from the bulb by compressing the metal tabs in the socket and gently rocking and slowly pulling the bulb from the socket. (FIGURE 7)
3. Remove the bulb from the unit. Disconnect the spacer from end of old bulb and secure it to the end of new bulb. (FIGURE 8)
4. Insert new bulb into the housing, leaving approximately 4" outside of the unit. Be sure to insert bulb straight and avoid angles, as this can damage the quartz sleeve. Do NOT force bulb in the unit. (FIGURE 9)

NOTE: Do NOT touch the bulb with your bare fingers, as this will shorten the life of the bulb. Use gloves or a cloth to hold the bulb. Clean the bulb with denatured alcohol and a clean, soft cloth if you do happen to touch the bulb.

5. Securely connect the socket to the bulb. Line up socket hole and safety pin (FIGURE 10) located on the inside of the quartz sleeve and insert bulb fully into the unit.
6. Hand tighten the threaded cap back onto the unit, making sure not to over-tighten. Double check to make sure all threaded fittings are tight. (FIGURE 11)
7. Before turning the UV unit back on, let the water run for a few minutes to ensure there are no leaks.
8. Once no leaks have been detected, plug the transformer (ballast) into a GFCI outlet.

Replacing or Cleaning the Quartz Sleeve

1. Follow steps one through three from UV bulb installation above.
2. Carefully remove the quartz sleeve from the housing.
3. To clean the quartz sleeve, various deposit removal cleaners can be used (vinegar, CLR, Lime-Away, etc.) DO NOT use any abrasive products as it may scratch the sleeve. Rinse thoroughly.
4. To replace or reinstall the quartz sleeve, simply insert the new sleeve back into the housing, being sure the end is seated properly in the end of the unit. (FIGURE 12)
5. Follow steps four through eight for reinstalling UV bulb, securing the unit and testing for leaks from the above UV bulb installation instructions.



FIGURE 6

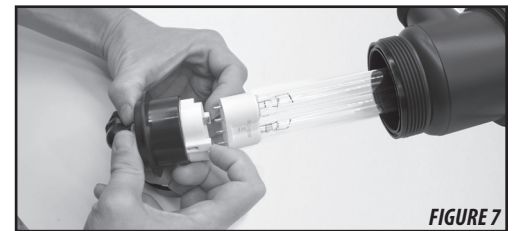

FIGURE 7

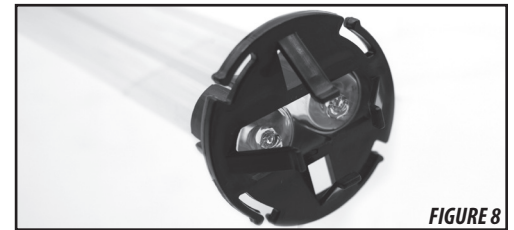

FIGURE 8



FIGURE 9

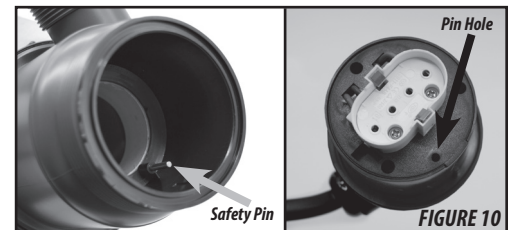

FIGURE 10



FIGURE 11

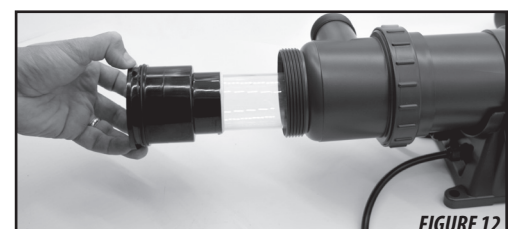
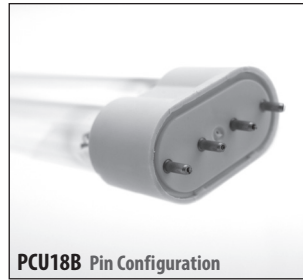

FIGURE 12

Replacement Parts

PART #	DESCRIPTION	DIMENSIONS
PC18B	18 Watt UV Bulb	8.75" H x 1.75" W x 1" D
PC36B	36 Watt UV Bulb	16.25" H x 1.75" W x 1" D
PC18S	18 Watt UV Sleeve	2.625" W x 10.375" L
PC36B	36 Watt UV Sleeve	2.625" W x 18" L
BARB3N	Inlet/Outlet Hose Barbed Connector Set	--



PC18B Pin Configuration



PC36B Pin Configuration



BARB3



PC36S

EasyPro Pond Products Limited Warranty

EasyPro Pond Products ("EasyPro") warrants to the purchaser that this product ("Product") will be free from any mechanical or material defects for a period of:

Housing: **Five years** from the date of purchase.

Transformer, Sleeve, Bulb: **One year** from the date of purchase. Broken UV bulbs or sleeves are not covered under this limited warranty. This warranty only covers properly installed and maintained Products sold by authorized EasyPro Sellers who are subject to and follow EasyPro's quality control standards. Please note that because EasyPro is unable to control the quality of Products sold by unauthorized sellers, unless otherwise prohibited by law, this warranty does not cover Products purchased from unauthorized sellers.

This warranty does not cover normal wear and tear, nor any deterioration suffered through overloading, improper use, negligence, improper installation, acts of God or accident. Similarly, any modification made by the purchaser to the Product will cause the warranty to be null and void. This warranty does not cover any cost associated with the installation or removal of the Product subject to a warranty claim.

All returned items will be inspected to determine cause of failure before a warranty claim is approved.

The exclusive remedies provided hereunder shall, upon EasyPro's inspection and option, be either repair or replacement of the Product or parts covered under this warranty.

Making a Claim: A Return Authorization ("RA") number must first be obtained by calling EasyPro at 800-448-3873 or via email at warranty@easypro.com. It is the purchaser's responsibility to pay the return shipping charges. Be sure to include the RA number, original receipt (in the form of an invoice or sales receipt), your name, your return address and your phone number inside of the package. No warranty claims will be honored without the original receipt that shows that your purchase was made from an Authorized EasyPro Seller. Ensure the product is properly packaged and insured for the replacement value. Damage due to improper packaging is the responsibility of the sender.

ALL OTHER EXPRESS OR IMPLIED WARRANTIES INCLUDING MERCHANTABILITY OF FITNESS FOR A PARTICULAR PURPOSE ARE HEREBY LIMITED IN DURATION TO THE DURATION OF THE WARRANTY AS DESCRIBED ABOVE. Some States do not allow limitations on how long an implied warranty lasts, so the above limitations may not apply to you.

EasyPro shall not be held liable for any damages caused by defective components or materials of this Product; or for loss incurred because of the interruption of service; or any consequential/incidental damages and expenses arising from the production, sale, use or misuse of this Product. Some States do not allow the exclusion or limitation of incidental or consequential damages, so the above limitation or exclusion may not apply to you.

EasyPro shall not be held liable for any loss of fish, plants or any other livestock as a result of any failure or defect of this Product. This warranty gives you specific legal rights, and you may also have other rights that vary from state to state.



800-448-3873 • Grant, Michigan • www.easypro.com