

User Manual

for QuicTent Party Tent



Please read, understand, and practice the guidelines in this user manual before use, and keep it for future reference.

4m x 6m
4m x 8m
5m x 10m

6m x 10m
6m x 12m

5m x 6.8m
6.5m x 8.9m

Table of Contents

● About Quiccent	2
● Safety Instructions	3
● 4m x 6m (Model # GM1403W)	5
● 4m x 8m (Model #GM1404W)	9
● 5m x 10m (Model #GM1408W)	13
● 6m x 10m (Model #GM1412W)	18
● 6m x 12m (Model #GM1413W)	24
● 5m x 6.8m (Model #GM5501)	30
● 6.5m x 8.9m (Model #GM5502)	35
● Maintenance	41
● Warranty	41

IMPORTANT

We'd love to hear from our customers. If you have any questions about the manual, our products, and services, or would like us to help in any way, please feel free to contact the support team. We will reply in 12 hours (business days).

- Check **the Spam** and your **email Settings** if you do not receive a reply in time as it is probably blocked because our support team will always get back to you no later than the timeframe.
- Add the following email address to your CONTACT LIST in case of any blocking.
- Email: sales@quiccents.com, 2maxlead.uk@gmail.com.

This user manual applies to Quictent party tents in 4m x 6m, 4m x 8m, 5m x 10m, 6m x 10m, 6m x 12', 5m x 6.8m, and 6.5m x 8.9m. It will help you to get to know your Quictent party tent. Please read the guidelines in this manual and keep the manual for future reference.

We may update the manual without notice in advance. You can always search **"Quictent Instructions"** online for the latest version.

About Quictent

Founded in the early 21st century, Quictent has grown into a popular brand with reliable products and excellent customer services during the past decades. We started with pop up canopies, and then expanded to other 6 categories for shelters and the like including party tents, carports, greenhouses, shade sails, patio umbrellas and grow tents. Driven by the vision to create unique spaces to meet every specific need and become a part of America's landscape, we at Quictent would spare no effort to keep innovating.

Our Vision

Creating unique spaces to meet every specific need, and become a part of America's landscape.

Our Mission

To keep innovating and provide a wide range of reliable shelters and shades at consumer-grade prices with customer-first service.

Our Service

The customer-centric services are what we at Quictent take great pride in. In addition to the hassle-free warranty covering all Quictent products, an industrial-leading support team is standing behind at all times. Whenever you need help or have any suggestions and comments about our products, do not hesitate to reach us via sales@quictents.com or 2maxlead.uk@gmail.com. You're sure to get a to-the-point reply in 12 hours.

Safety Instructions

You should read, understand, and practice safety instructions in this chapter. For any damages due to not obeying guidelines as instructed, the owner (user) should take full responsibility.

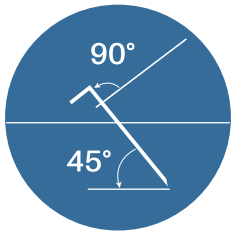

Do NOT insert the L-shaped pegs and the Auger Anchors vertically. As shown, an angle of 45-degree is recommended.



Do NOT leave a tent outdoors too long as it's designed to be used as a temporary structure.



Do NOT leave a tent unattended overnight.



Do NOT light a fire inside the party tents. Keep any heat source away from your party tents.

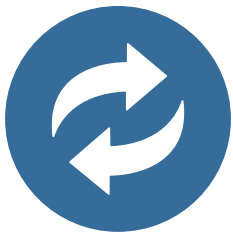

Do NOT throw away the original packaging cartons in case of a return or an exchange.



You can ALWAYS contact the support team for replacement parts whenever in need.

Reminder

Do not use and leave the structure outside in inclement weather. The owner (or user) should take down the structure for any potential inclement weather, including high winds, heavy rain, sleet, snow, and the like, or he (she) should take the loss.

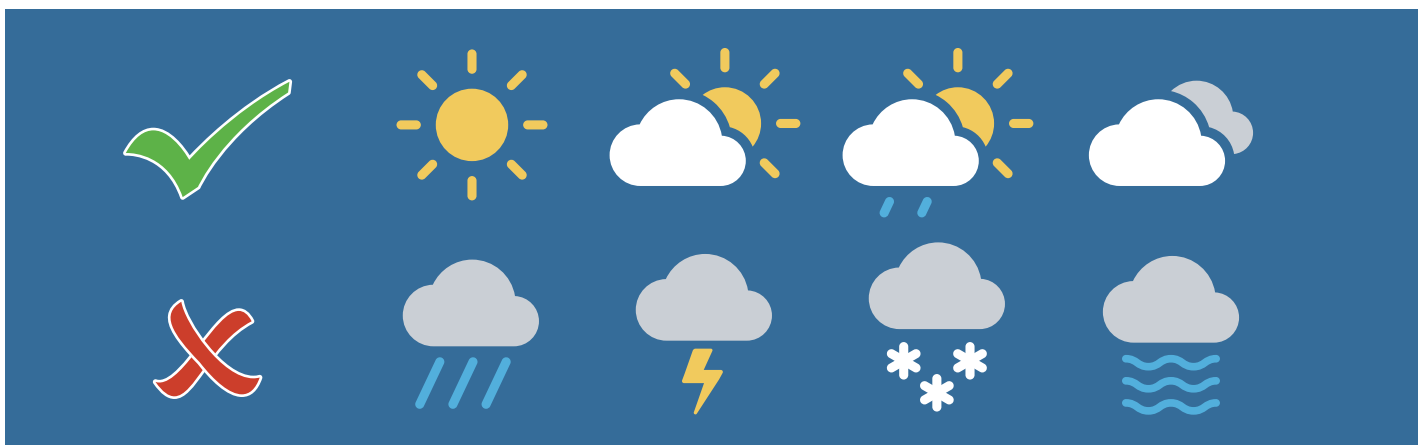

Warning

- Stop using the party tent immediately if any damage is found, or Quictent will not be liable for any loss thereafter.
- Please do NOT place heavy objects on the top of a Quictent party tent, or leave it outside overnight because it's designed to be used as a temporary structure.

You can find the **Parts List** and the **Assembly** steps for Quictent party tents in 4m x 6m, 4m x 8m, 5m x 10m, 5m x 6.8m, and 8.9m x 8.5m. Please check the shipping cartons and the parts inside accordingly upon arrival. If you have any questions, please email sales@quictents.com or 2maxlead.uk@gmail.com to get in touch with our customer support team. We will reply to your queries within 12 hours (business day). By the way, if you're requiring replacement parts, please include the following information in your message so that we can take action as soon as possible:

- ✓ Order number
- ✓ Part number
- ✓ Quantity required for each part number
- ✓ Any photos (or video clips, if applicable) to help us understand your concerns would be greatly appreciated.

IMPORTANT! Please disassemble your tents and put all the parts in the Carry Bags whenever you need to transport or store them.

4m x 6m (Model # GM1403W)

Parts List

You'll receive three (3) boxes for this model (**Model # GM1403W**). Please check to identify the packages by referring to **Table B** below. Pay particular attention to make sure all parts are numbered and graphically indexed as shown on the **Parts List (Table A)**, so does the quantity for each part. If you need any help, please contact us promptly (sales@quictents.com or 2maxlead.uk@gmail.com) with **the order number, required part(s), quantity for each part, and photos** (or video clips, if applicable), we will get back within 12 hours to help out.

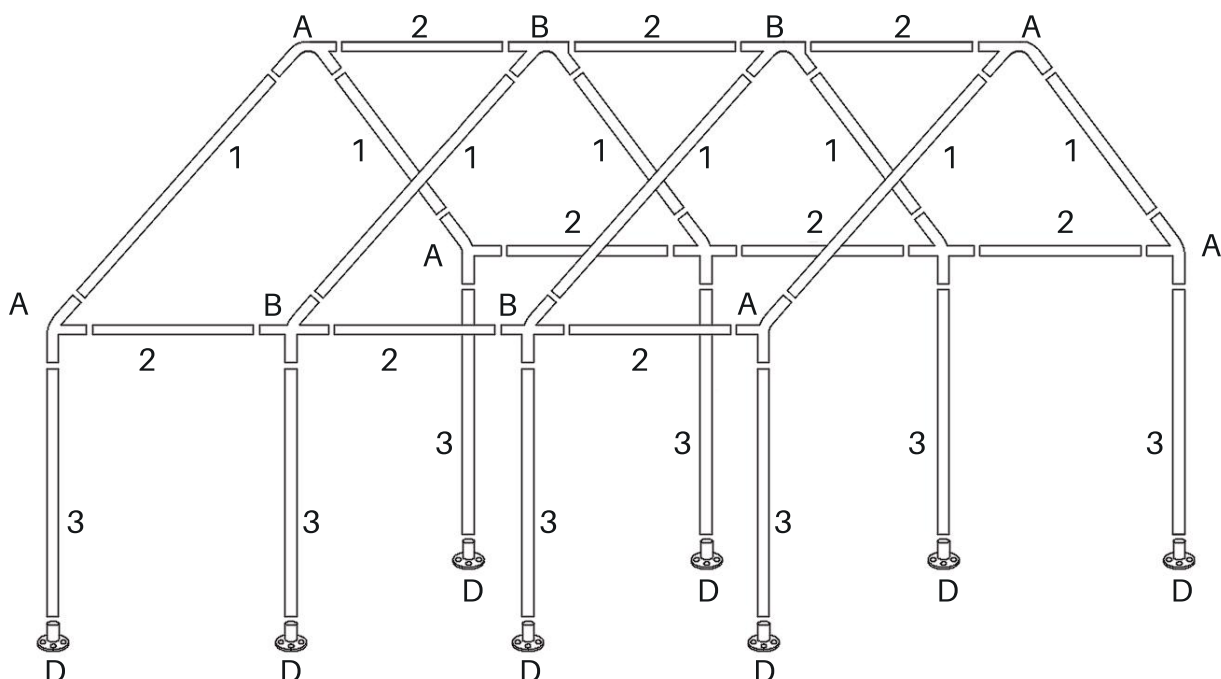

Table A. Parts List











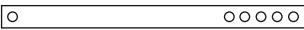

Part Number	Diagram	Description	Quantity (PCS)
#1		Steel Pipe (2.06m)	8
#2		Steel Pipe (1.93m)	9
#3		Steel Pipe (1.91m)	8
#A		3-Way Corner Connector	6
#B		4-Way Corner Connector	6
#C		L-Shaped Peg	24
#D		Foot Base	8
#E		M8*50 Screw	8
#F		Guy Rope	8
#G		Roof Cover	1
#H		Sidewall with Window	6
#I		Zipper Door	2
#J		Bungee Cord	100
#K		Carry Bag	2

Table B. Package Contents for Shipping Cartons

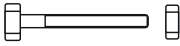
Part Number	Parts Included
Box #1	8 x Part #1 (Steel Pole) 4 x Part #2 (Steel Pole)
Box #2	5 x Part #2 (Steel Pole) 8 x Part #3 (Steel Pole)
Box #3	1 x Part #G (Roof Cover) 2 x Part #I (Zipper Door) 6 x Part #H (Sidewall with Window) All the Other Accessories not Mentioned in this Table

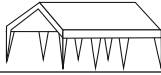
Assembly

Read Before the Assembly

Please check to make sure that you have all the parts listed on the **Parts Lists**.

Step 1 Form the top frame as per the layout. The parts you'll use in this step are poles of 8 x #1 & 9 x #2 and connectors of 6 x #A & 6 x #B.

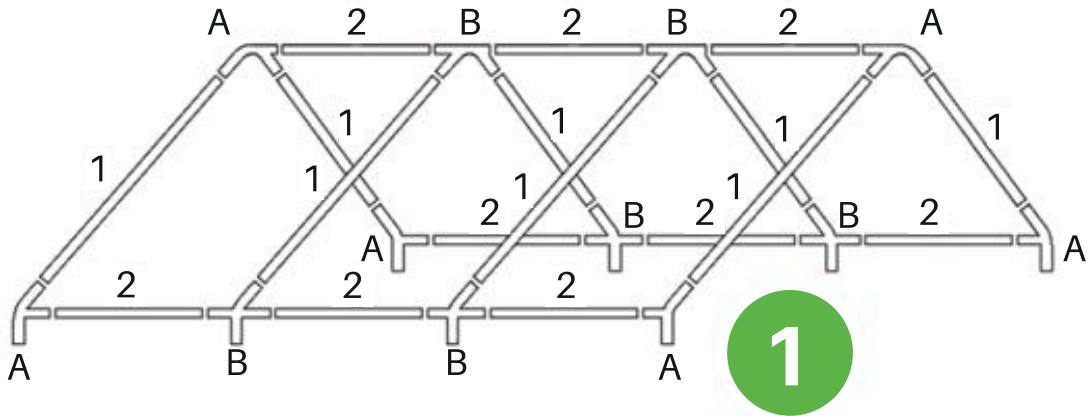

Step 2 Tighten the Roof Cover (#G) to the assembled top frame with the Bungee Cords (#J).

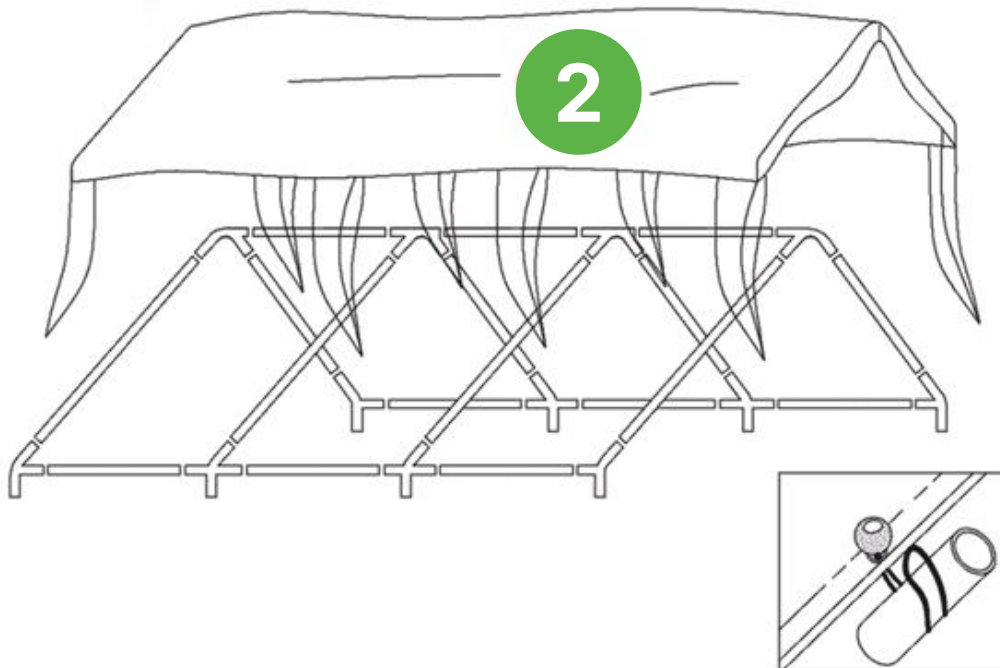

Step 3 There are 3 reminders for the assembly of the poles (#3).

- The end **WITHOUT** the adjusting holes should be connected to the connectors on the top frame (#A & #B).
- Fix the other end (with adjusting holes) to the Foot Bases (#D) with the M8*50 Screws (#E).
- The leg cover with a hook is attached to the roof cover. You can tighten/loosen it by placing the hook into the different adjusting holes in the poles (#3).

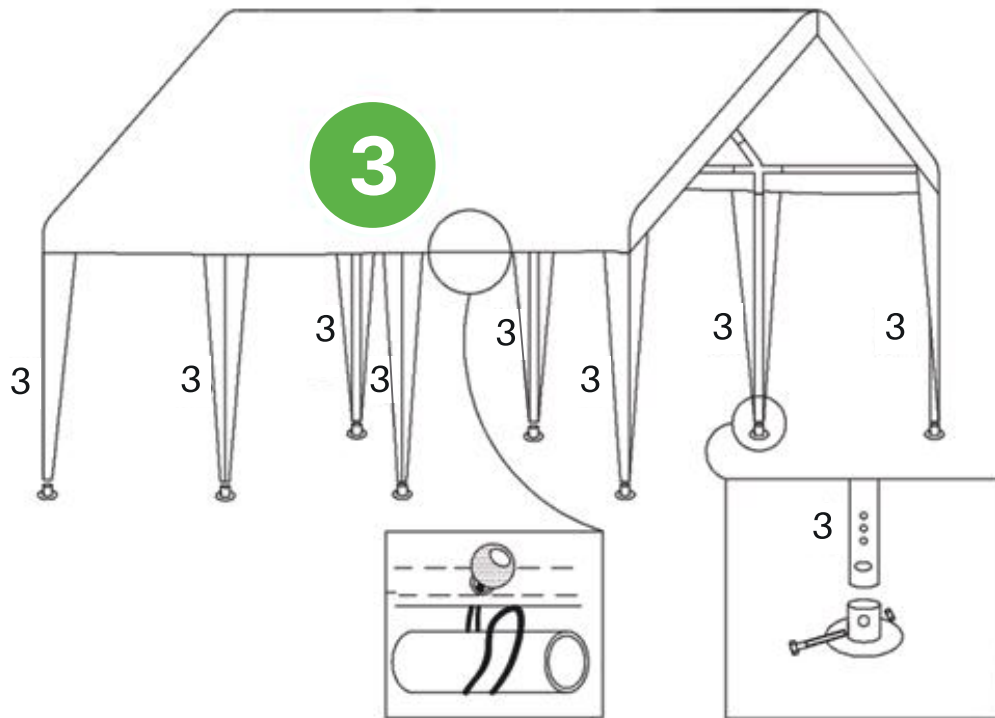

Step 4 Attach the 6 x Sidewalls with Window (#H) and the 2 x Zipper Doors (#I) as instructed below.

- Firstly, you need to fix all the sides and doors to the top frame with the Bungee Cords (#J).
- After fixing the window sides to the ground, please also fix the sides to the poles by wrapping up the built-in velcros.
- Please fix the structure to the ground with the 8 x Guy Ropes (#F) and the 8 x L-Shaped Pegs (#C). To secure the tent better, it is recommended that you insert the L-Shaped Pegs **diagonally** into the ground. As shown, at a 45-degree to the ground is the best position.
- Fix the structure to the ground by inserting the L-Shaped Pegs (#C) into the hole of the foot bases.

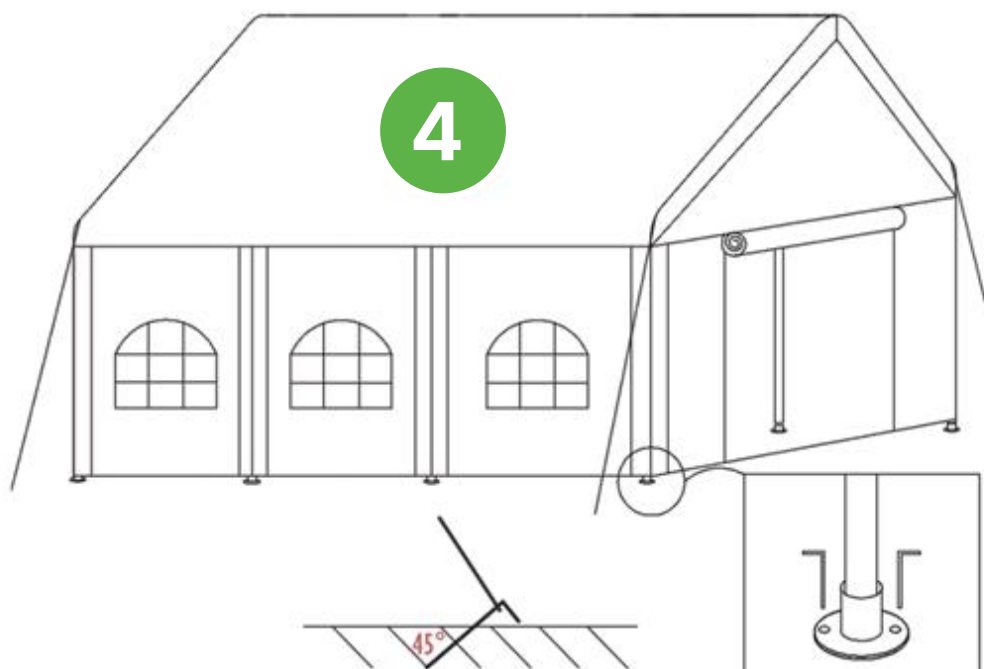

4m x 8m (Model #GM1404W)

Parts List

You'll receive three (3) boxes for this model (**Model # GM1404W**). Please check to identify the packages by referring to **Table B** below. Pay particular attention to make sure all parts are numbered and graphically indexed as shown on the **Parts List (Table A)**, so does the quantity for each part. If you need any help, please contact us promptly (sales@quictents.com or 2maxlead.uk@gmail.com) with **the order number, required part(s), quantity for each part, and photos** (or video clips, if applicable), we will get back within 12 hours to help out.

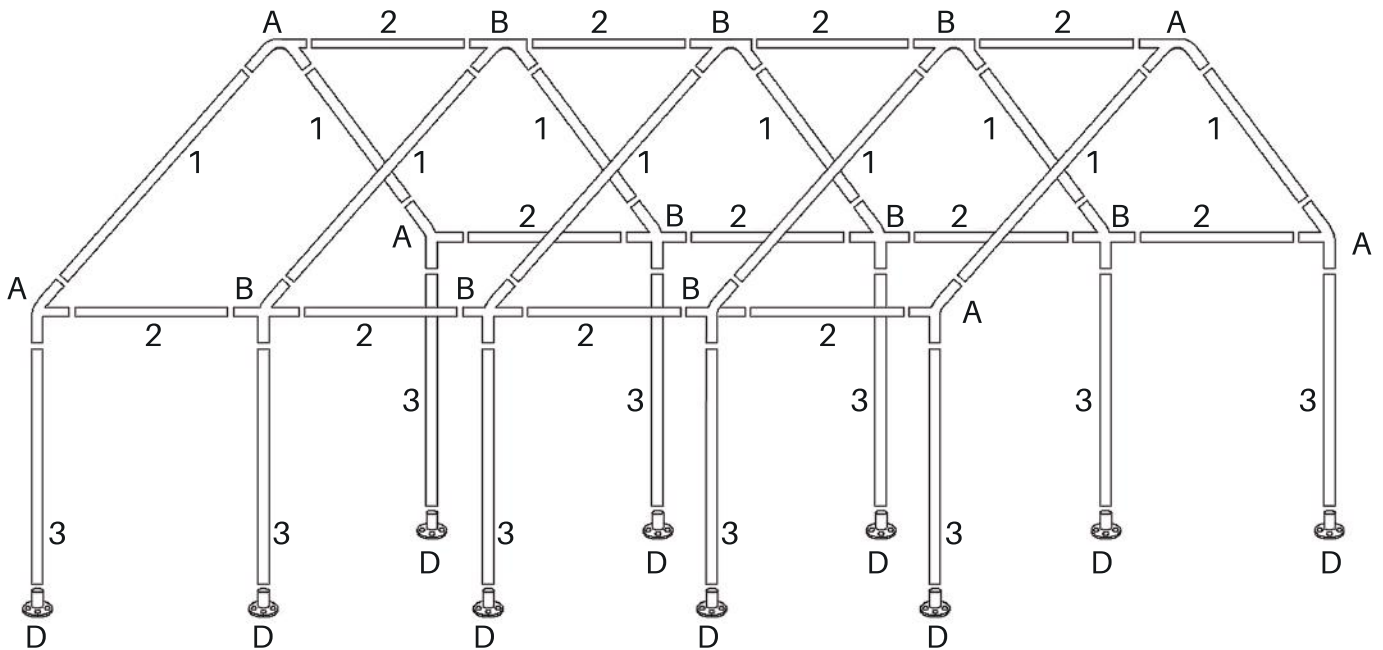

Table A. Parts List

Part Number	Diagram	Description	Quantity (PCS)
#1		Steel Pipe (2.06m)	10
#2		Steel Pipe (1.93m)	12
#3		Steel Pipe (1.91m)	10
#A		3-Way Corner Connector	6
#B		4-Way Corner Connector	9
#C		L-Shaped Peg	30
#D		Foot Base	10







Part Number	Diagram	Description	Quantity (PCS)
#E		M8*50 Screw	10
#F		Guy Rope	10
#G		Roof Cover	1
#H		Sidewall with Window	8
#I		Zipper Door	2
#J		Bungee Cord	132
#K		Carry Bag	2

Table B. Package Contents for Shipping Cartons

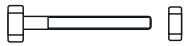
Part Number	Parts Included
Box #1	10 x Part #1 (Steel Pole) 6 x Part #2 (Steel Pole)
Box #2	6 x Part #2 (Steel Pole) 10 x Part #3 (Steel Pole)
Box #3	1 x Part #G (Roof Cover) 2 x Part #H (Zipper Door) 8 x Part #I (Sidewalls with Window) All the Other Accessories not Mentioned in this Table

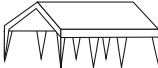
Assembly

Read Before the Assembly

Please check to make sure that you have all the parts listed on the **Parts Lists**.

Step 1 Form the top frame as per the layout. The parts you'll use in this step are poles of 10 x #1 & 12 x #2 and connectors of 6 x #A & 9 x #B.

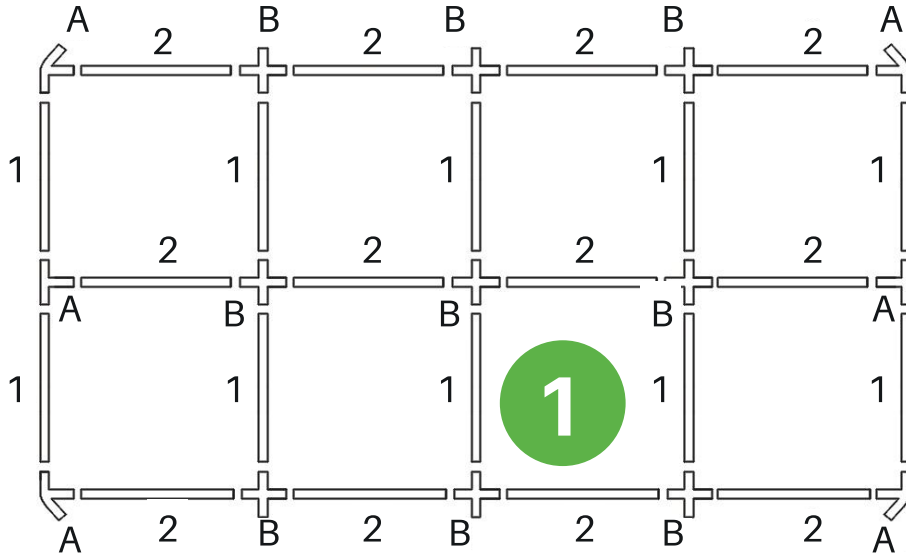

Step 2 Tighten the Roof Cover (#G) to the assembled top frame with the Bungee Cords (#J).

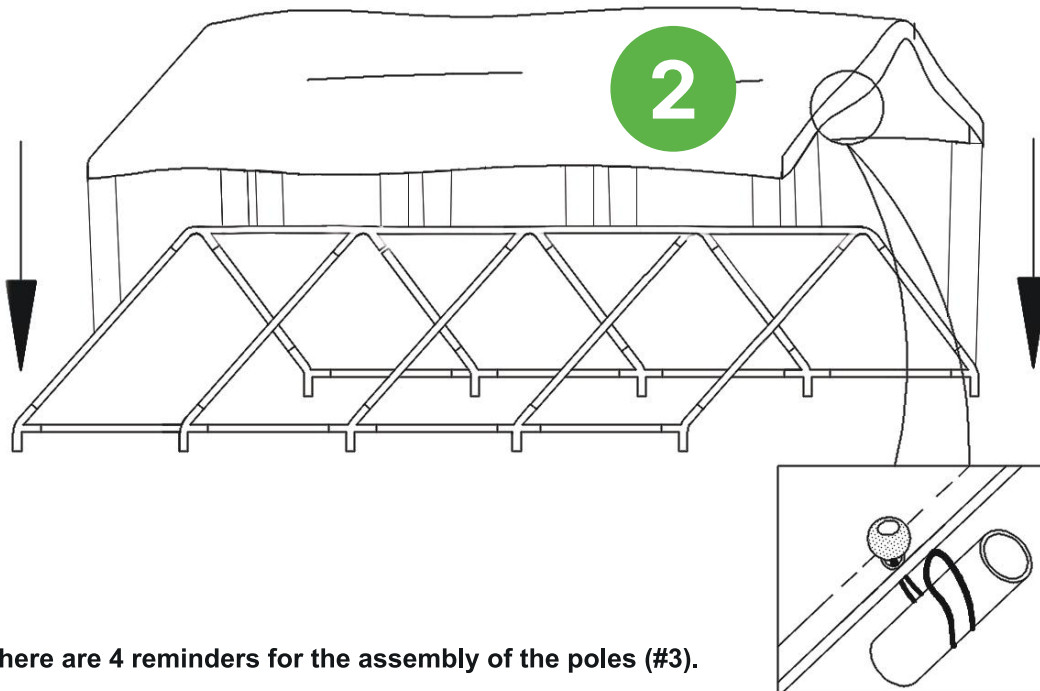

Step 3 There are 4 reminders for the assembly of the poles (#3).

- The end **WITHOUT** the adjusting holes should be connected to the connectors on the top frame (#A & #B).
- Fix the other end (with adjusting holes) to the Foot Bases (#D) with the M8*50 Screws (#E).
- The leg cover with a hook is attached to the roof cover. You can tighten/loosen it by placing the hook into the different adjusting holes in the poles (#3).

- You should ALWAYS remember to fix the structure by inserting the L-Shaped Pegs (#C) into the hole of the foot bases accordingly.

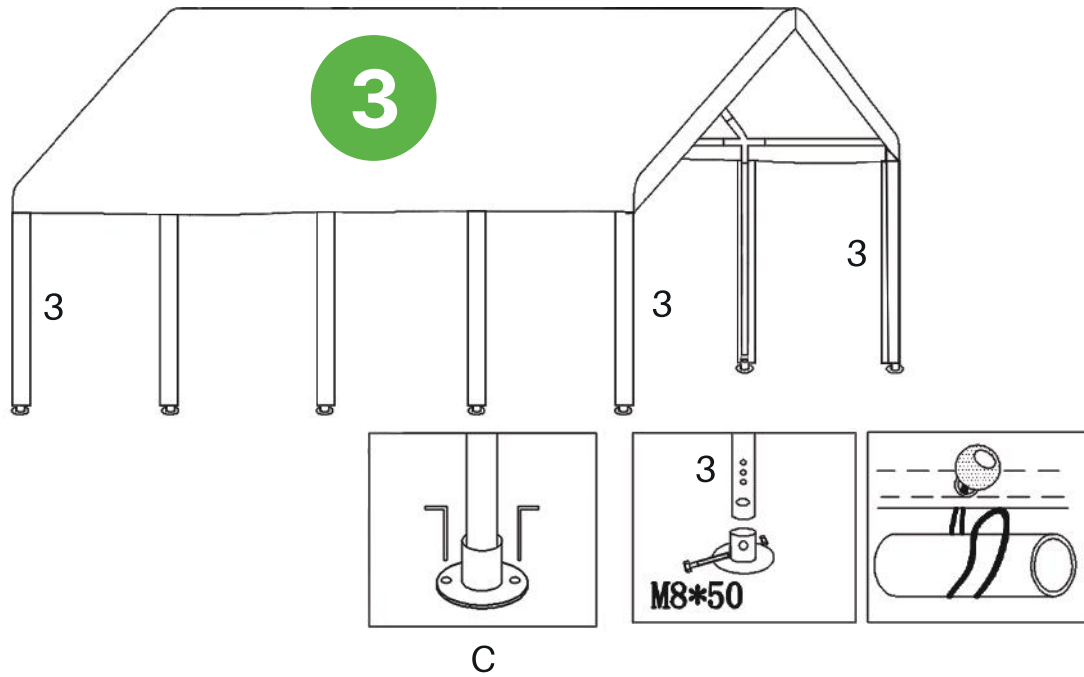

Step 4 Attach the 8 x Sidewalls with Window (#H) and the 2 x Zipper Doors (#I) as instructed below.

- Firstly, you need to fix all the sides and doors to the top frame with the Bungee Cords (#J).
- After fixing the window sides to the ground, please also fix the sides to the poles by wrapping up the built-in velcros.
- Please fix the structure to the ground with the 10 x Guy Ropes (#F) and the 10 x L-Shaped Pegs (#C). To secure the tent better, it is recommended that you insert the L-Shaped Pegs diagonally into the ground. As shown, at a 45-degree to the ground is the best position.

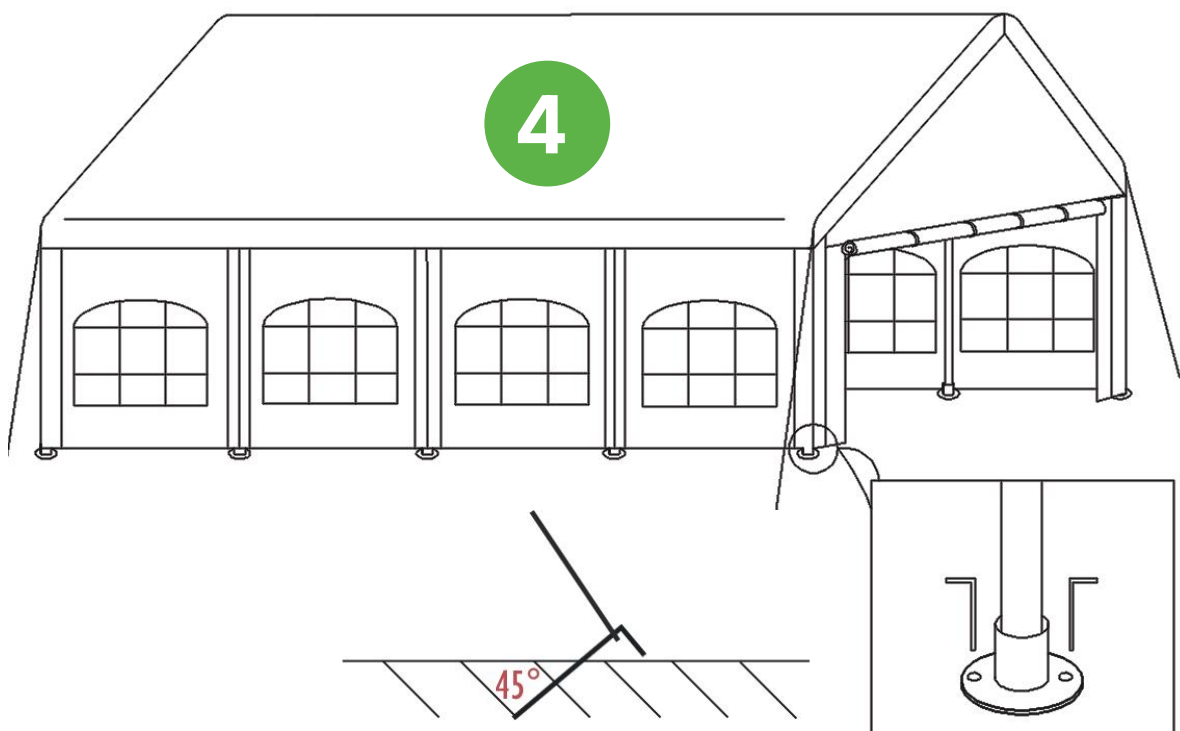

5m x 10m (Model #GM1408W)

Parts List

You'll receive four (4) boxes for this model (**Model # GM1408W**). Please check to identify the packages by referring to **Table B** below. Pay particular attention to make sure all parts are numbered and graphically indexed as shown on the **Parts List (Table A)**, so does the quantity for each part. If you need any help, please contact us promptly (sales@quictents.com or 2maxlead.uk@gmail.com) with **the order number, required part(s), quantity for each part, and photos** (or video clips, if applicable), we will get back within 12 hours to help out.

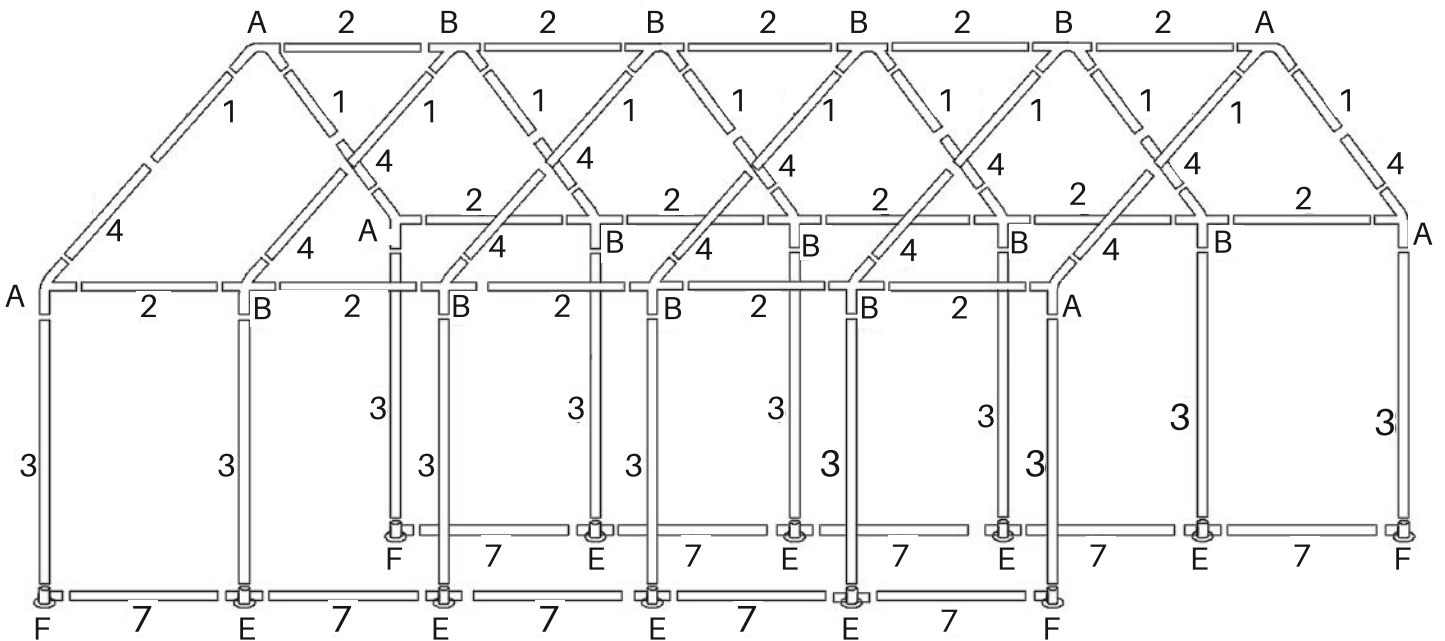

Table A. Parts List

Part Number	Diagram	Description	Quantity (PCS)
#1		Steel Pole (0.75m)	12
#2		Steel Pole (1.93m)	15
#3		Steel Pole with Adjusting Holes (1.93m)	12
#4		Steel Pole (1.93m)	12
#7		Ground Bar (1.93m)	10
#A		3-Way Corner Connector	6











Part Number	Diagram	Description	Quantity (PCS)
#B		4-Way Corner Connector	12
#C		L-Shaped Peg	36
#D		Bungee Cord	192
#E		L-Shaped Foot Base (2-Corner)	4
#F		T-Shaped Foot Base (3-Corner)	8
#G		M8*50 Screw	12
#H		Guy Rope	12
#I		Roof Cover	1
#J		Sidewall with Window	10
#K		Zipper Door	2
#L		Carry Bag	3

Table B. Package Contents for Shipping Cartons

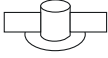
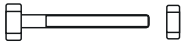
Part Number	Parts Included
Box #1	12 x Part #1 (Steel Pole) 12 x Part #4 (Steel Pole) 5 x Part #2 (Steel Pole)
Box #2	10 x Part #2 (Steel Pole) 12 x Part #3 (Steel Pole) 10 x Part #7 (Steel Pole)
Box #3	All the Accessories not Mentioned in this Table
Box #4	1 x Part #I (Roof Cover) 2 x Part #K (Zipper Door) 10 x Part #J (Sidewalls with Window)

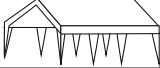
Assembly

Read Before the Assembly

Please check to make sure that you have all the parts listed on the **Parts Lists**.

Step 1 Form the top frame as per the layout. The parts you'll use in this step are poles of 12 x #1, 15 x #2, 12 x #4 and connectors of 6 x #A & 12 x #B.

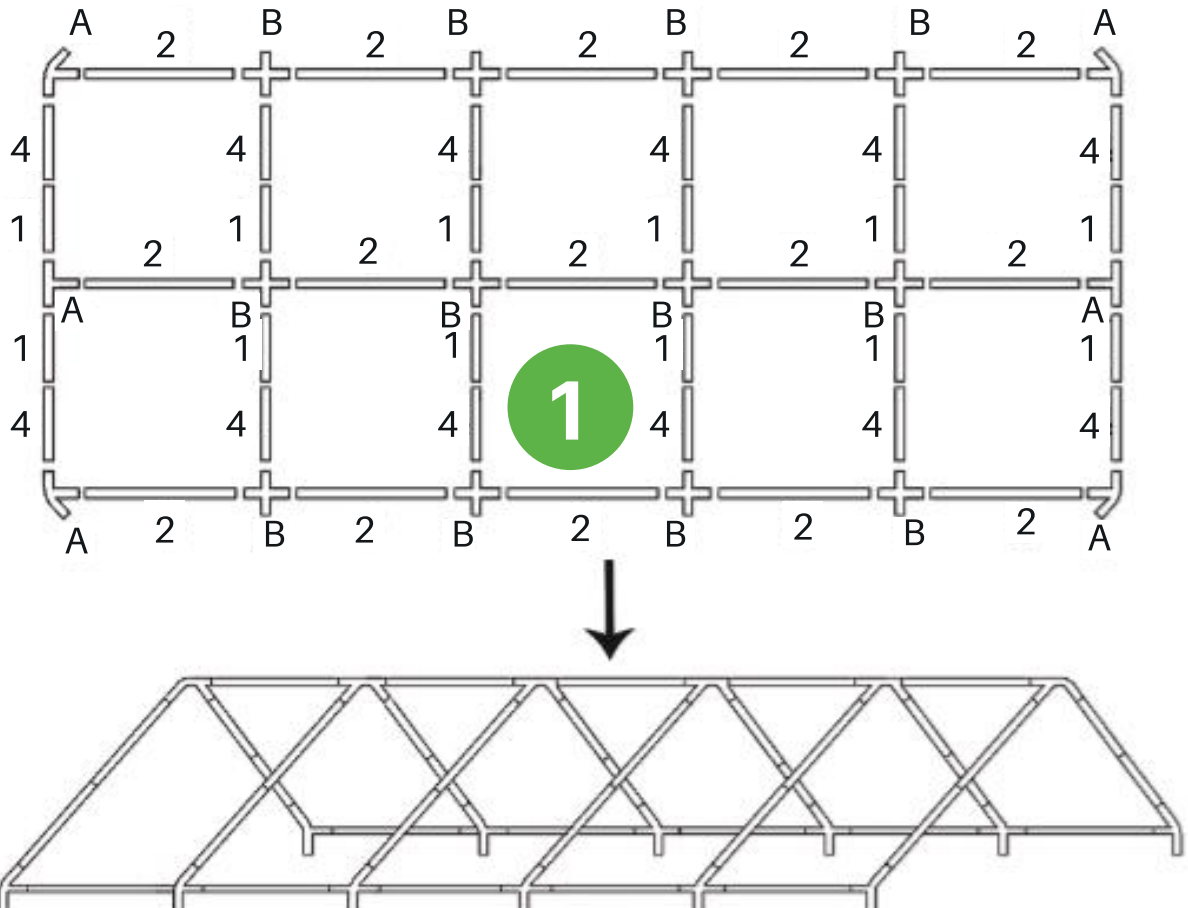

Step 2 Tighten the Roof Cover (#I) to the assembled top frame with the Bungee Cords (#D).

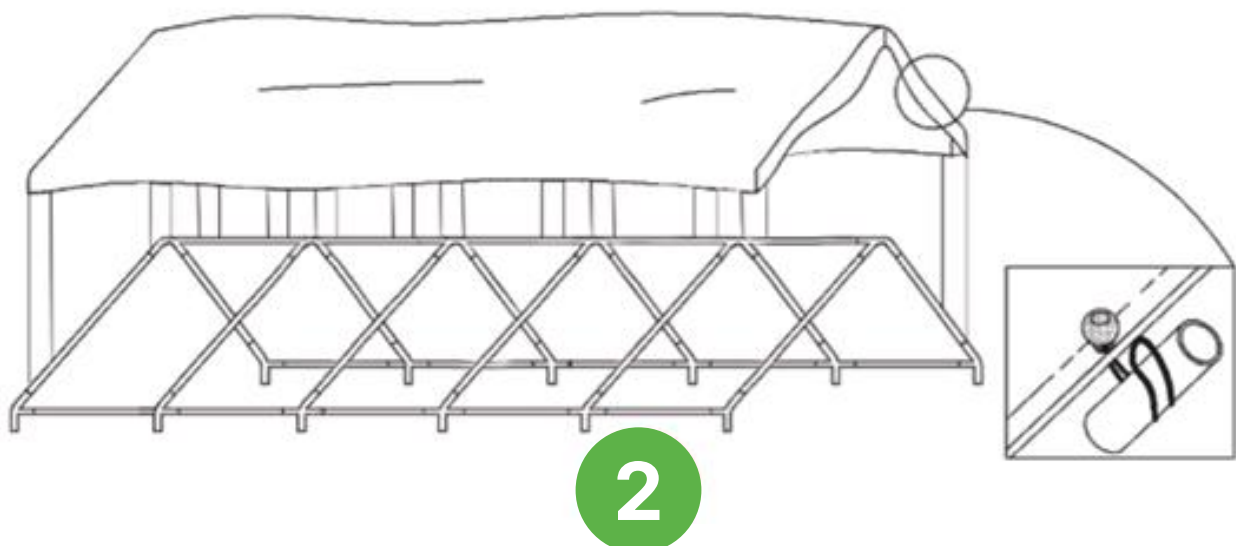

Step 3 Connect 6 x poles (#3) (the end should be the one **WITHOUT** the adjusting holes) with the connectors of (#A & #B) on the top frame, then lift the structure from the other side (**SEVERAL ADULTS REQUIRED!**).

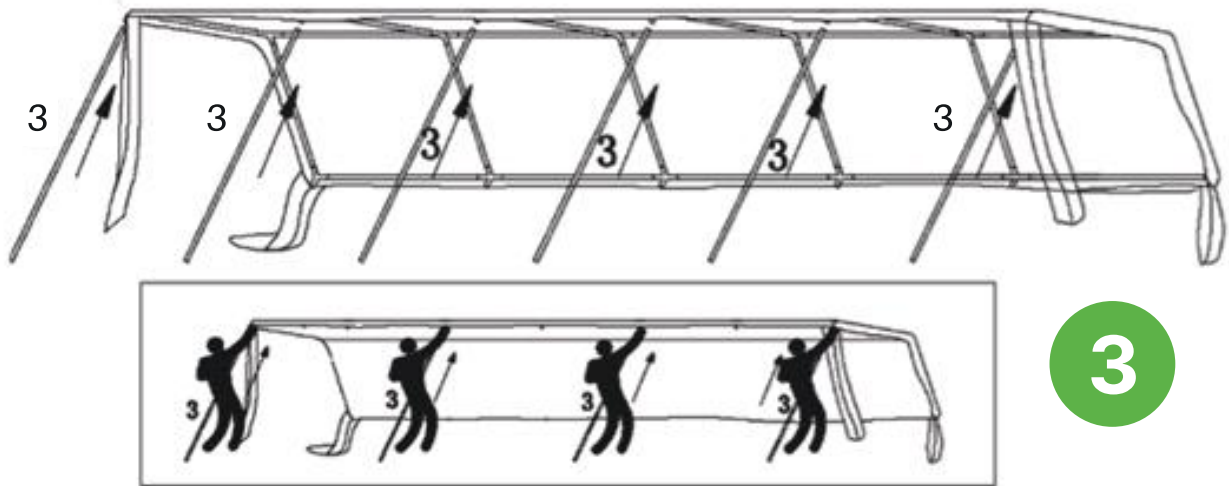

Step 4 Assemble the poles (6 x #3 & 10 x #7) with the L-Shaped Foot Bases (#E) and the T-Shaped Foot Bases (#F). There are three gentle reminders:

- The Foot Bases (#F) are used to connect the poles (#3) at the four corners.
- You can tighten/loosen the leg cover by placing the hook on the different adjusting holes.
- Please remember to fix the structure with the L-Shaped Pegs (#C) after finishing connecting all the poles.

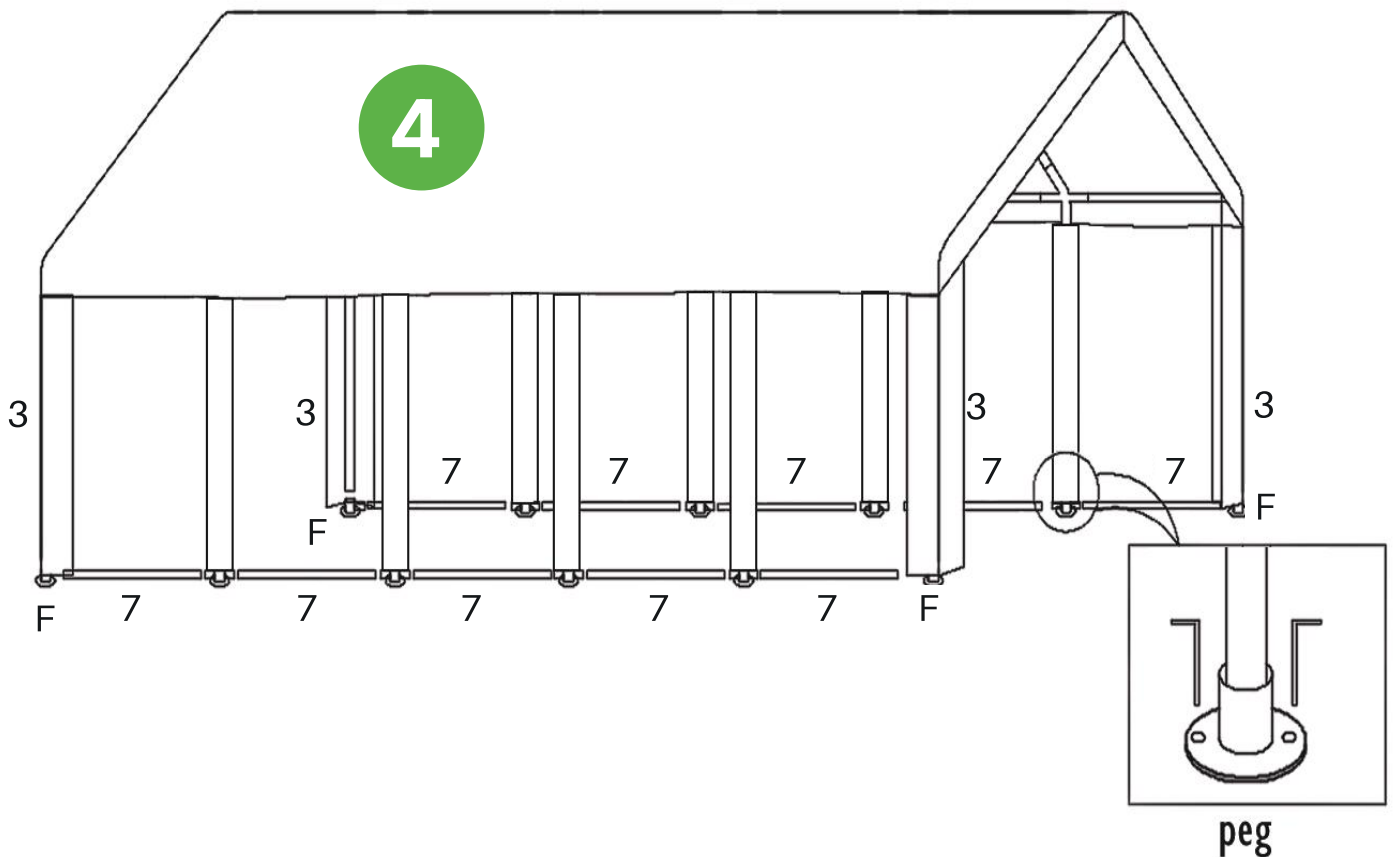

Step 5 Attach the 10 x Sidewalls with Window (#K) and the 2 x Zipper Doors (#L) as instructed below.

- a) Firstly, you need to fix all the sides and doors to the top frame with the Bungee Cords (#E).
- b) After fixing the window sides to the ground, please also fix them to the poles by wrapping up the built-in velcros.
- c) Finally, please fix the structure to the ground with the 12 x Guy Ropes (#I) and the 12 x L-Shaped Pegs (#C). To secure the tent better, it is recommended that you insert the L-Shaped Pegs diagonally into the ground. As shown, at a 45-degree to the ground is the best position.

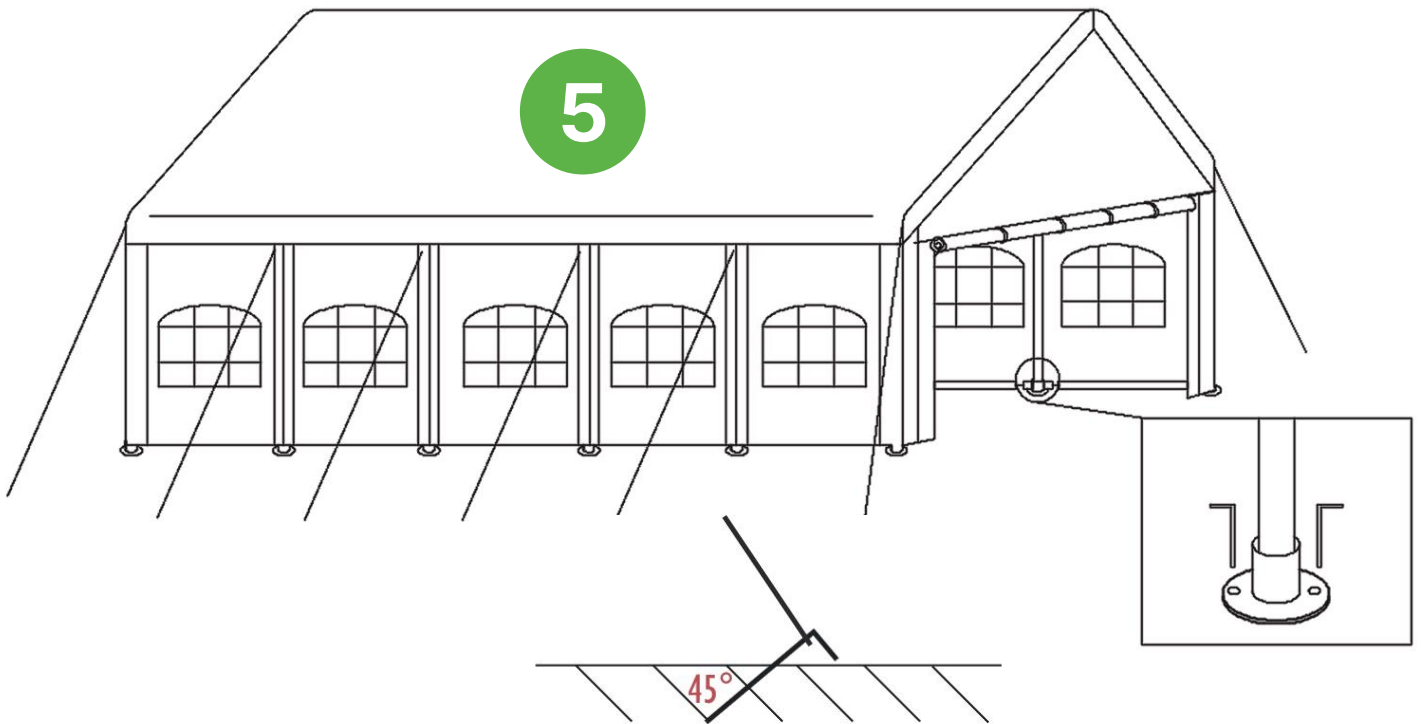

6m x 10m (Model #GM1412W)

Parts List

You'll receive five (5) boxes for this model (**Model # GM1412W**). Please check to identify the packages by referring to **Table B** below. Pay particular attention to make sure all parts are numbered and graphically indexed as shown on the **Parts List (Table A)**, so does the quantity for each part. If you need any help, please contact us promptly (sales@quictents.com or 2maxlead.uk@gmail.com) with **the order number, required part(s), quantity for each part, and photos** (or video clips, if applicable), we will get back within 12 hours to help out.

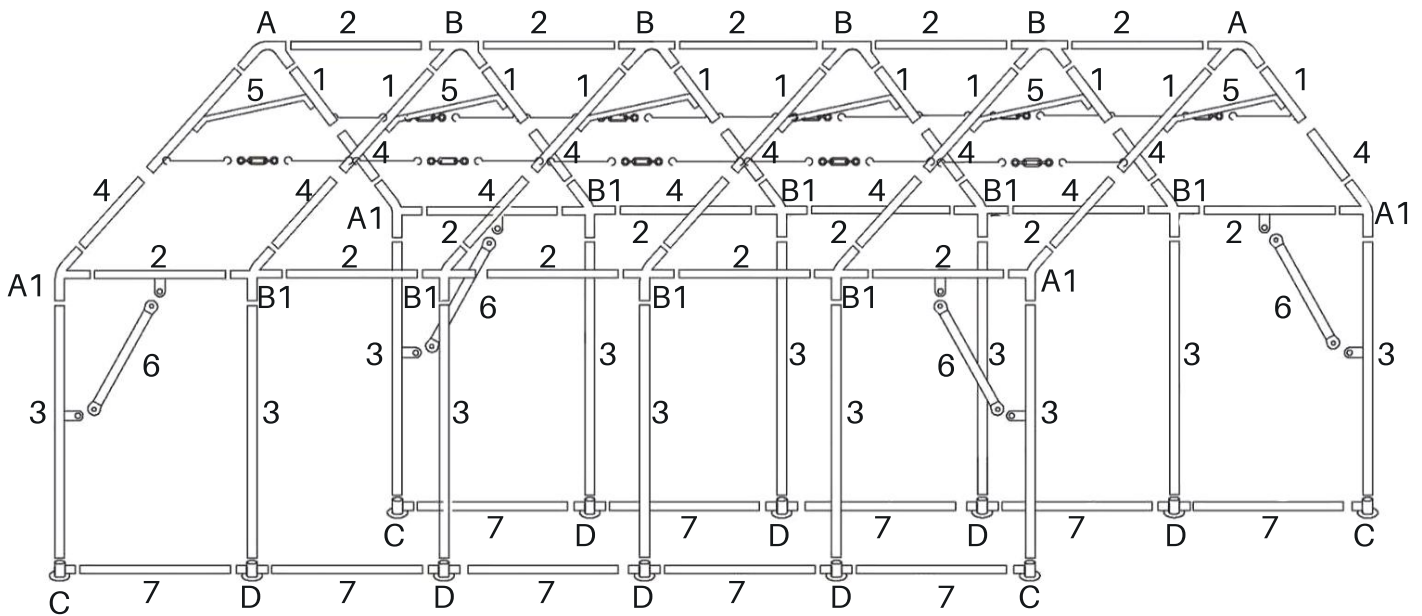

Table A. Parts List

Part Number	Diagram	Description	Quantity (PCS)
#1		Steel Pole (1.93m)	12
#2		Steel Pole (1.93m)	15
#3		Steel Pole (1.93m)	12
#4		Steel Pole (1.28m)	12
#5		Steel Pole (1.88m)	6
#6		Steel Pole (1.4m)	4
#7		Ground Bar (1.93m)	10
#A		3-Way Corner Connector	2











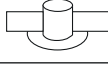
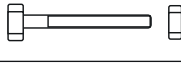
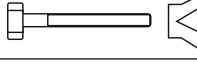
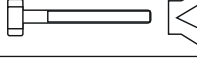

Part Number	Diagram	Description	Quantity (PCS)
#A1		3-Way Corner Connector	4
#B		4-Way Corner Connector	4
#B1		4-Way Corner Connector	8
#C		L-Shaped Foot Base (2-Corner)	4
#D		T-Shaped Foot Base (3-Corner)	8
#E		M8*50 Screw	12
#F		M6*25 Screw	8
#G		M6*70 Screw	12
#H1		Wire Rope	20
#H2		Cable Clip	10
#I		Guy Rope	12
#J		L-Shaped Peg	36
#K		Bungee Cord	148
#L		Roof Cover	1
#M		Sidewall with Window	10
#N		Zipper Door	2
#O		Pole Holder	8
#P		Carry Bag	4

Table B. Package Contents for Shipping Cartons

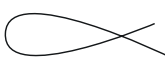
Part Number	Parts Included
Box #1	12 x Part #1 (Steel Pole) 12 x Part #3 (Steel Pole) 20 x Part #H1(Wire Rope)
Box #2	15 x Part #2 (Steel Pole) 4 x Part #6 (Steel Pole)
Box #3	12 x Part #4 (Steel Pole) 6 x Part #5 (Steel Pole) 10 x Part #7 (Steel Pole)
Box #4	10 x #H2(Cable Clip) All the Other Accessories not Mentioned in this Table
Box #5	1 x Part #L (Roof Cover) 2 x Part #N (Zipper Door) 10 x Part #M (Sidewall with Window)

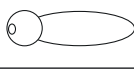
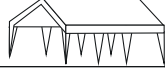
Assembly

Read Before the Assembly

Please check to make sure that you have all the parts listed on the **Parts Lists**.

Step 1 Form the top frame as per the layout instructed. You'll use poles of 12 x #1, 15 x #2, 12 x #4 and connectors of 2 x #A, 4 x #A1, 4 x #B, 8 x #B1 in this step.

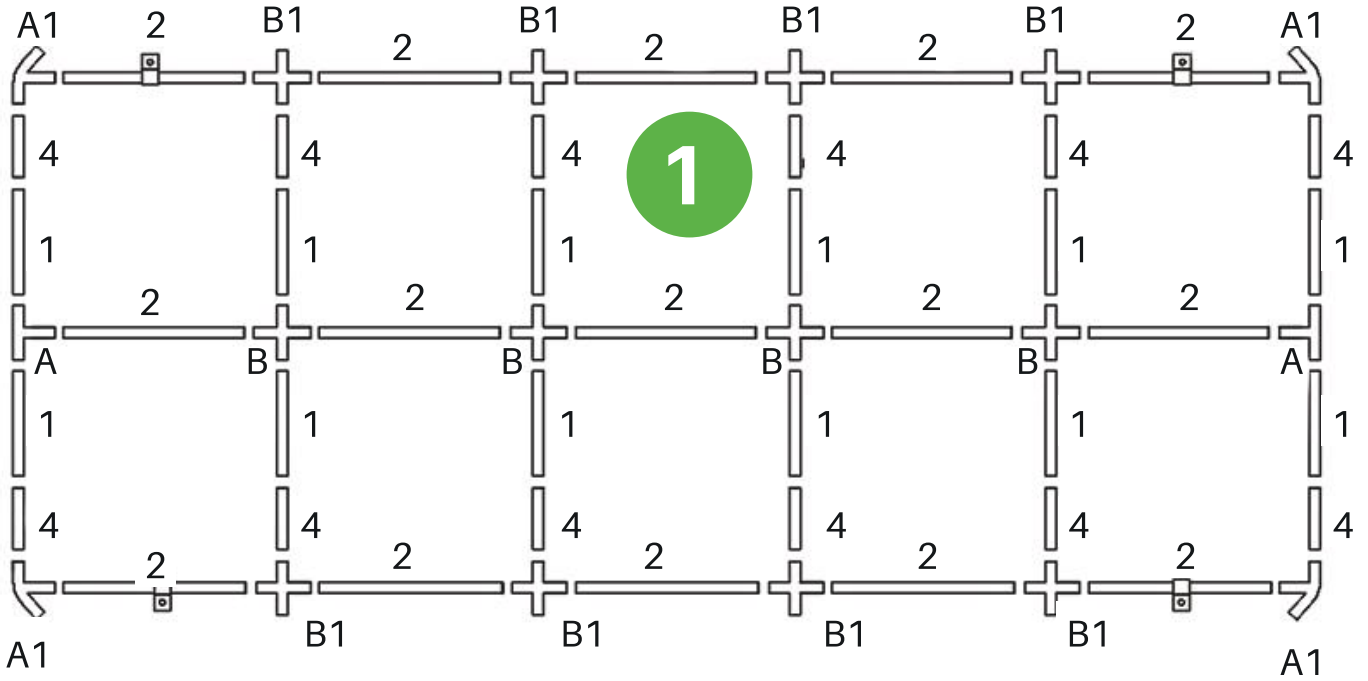

Step 2 Attach the 4 x Pole Holder (#O) to the poles (#2) accordingly and reinforce the top frame with the 6 x poles (#5) and the Steel Rope Sets (#H). You'll also use 12 x M6*70 Screw (#G) in this step.

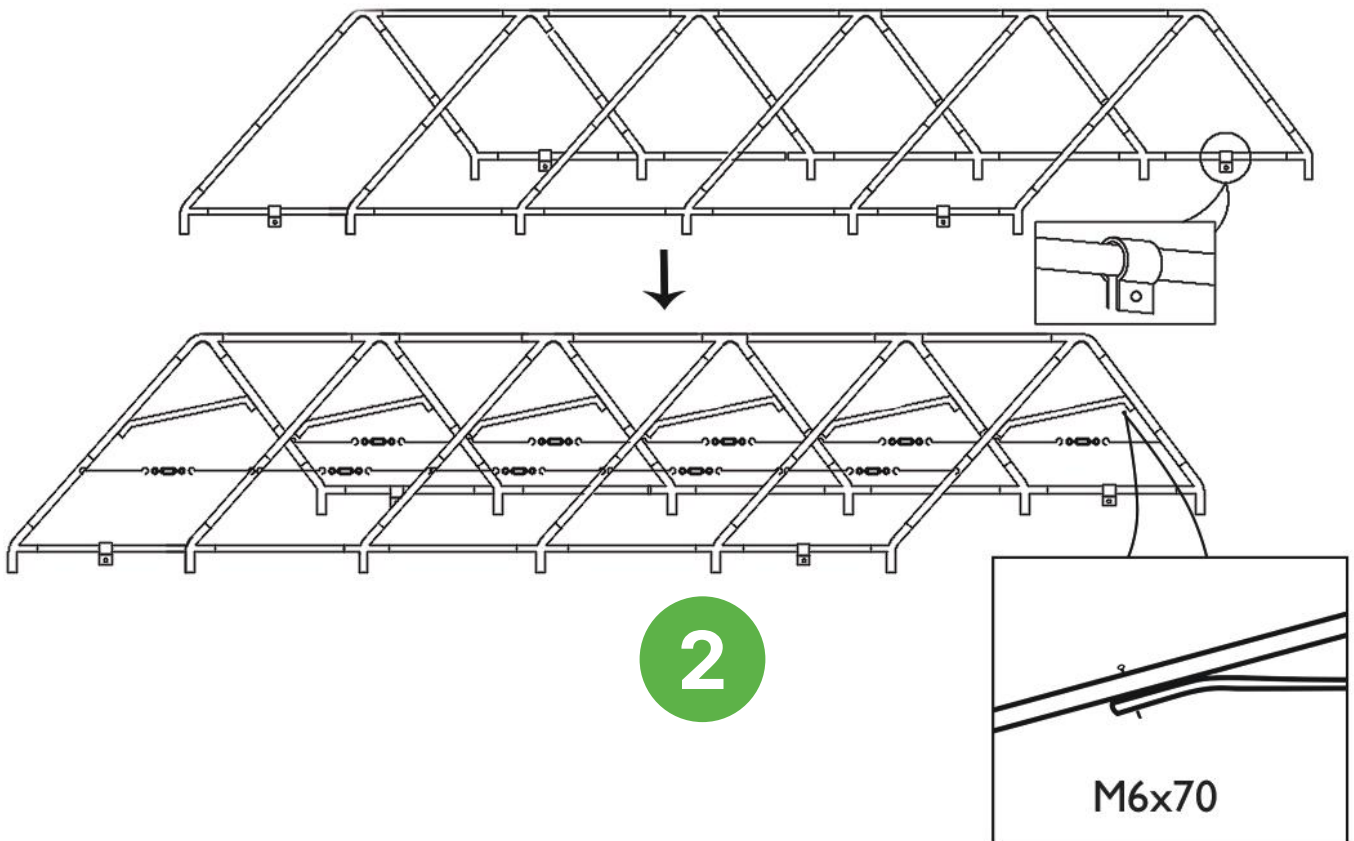

Step 3 Tighten the Roof Cover (#L) with the top frame by using the Bungee Cords (#K).

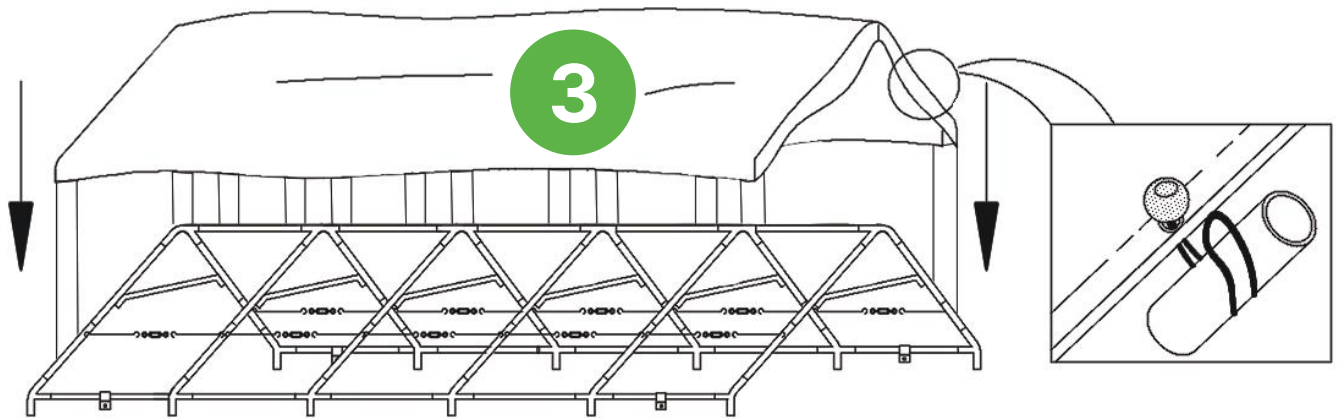

Step 4 Connect 6 x poles (#3) with the connectors (#A1 & #B1) accordingly and lift the structure from the other side (**SEVERAL ADULTS REQUIRED!**).

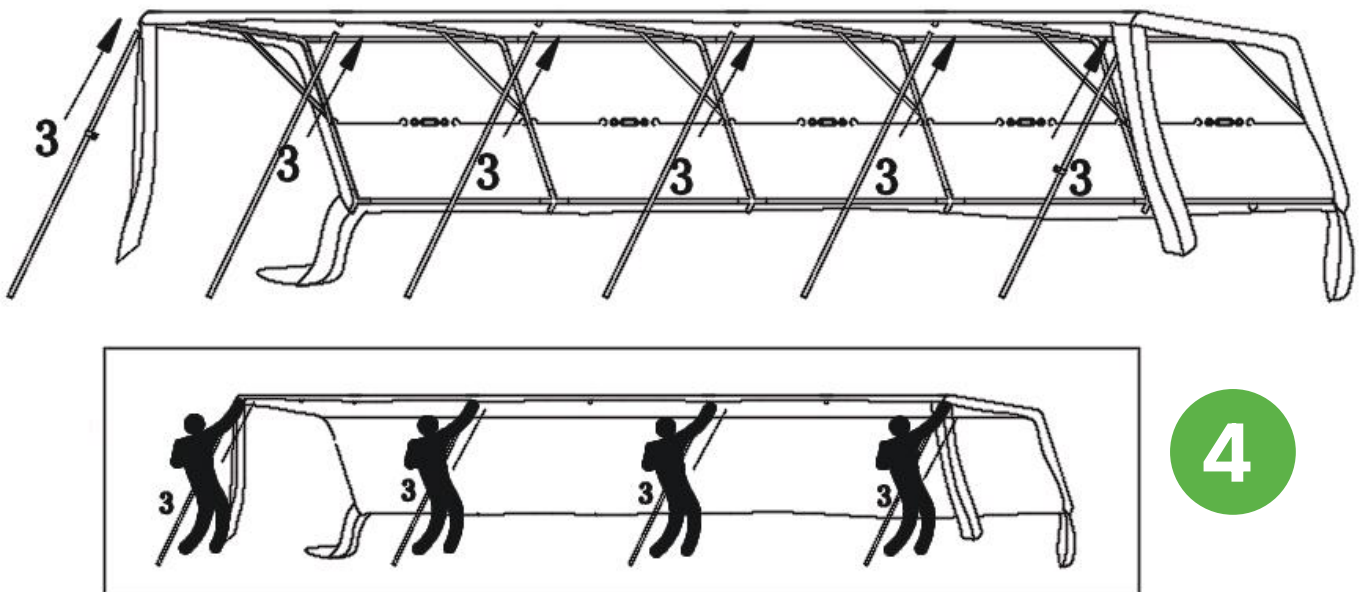

Step 5 Finish assembling the supporting frame by:

- Connecting the remaining 6 x poles (#3).
- Tightening/Loosening the leg covers by placing the hooks on the different adjusting holes (on the #3 poles).
- Connecting the poles (#3) with the poles (#7) by using the 4 x L-Shaped Foot Bases (#C) and the 8 x T-Shaped Foot Bases (#D). You'll use 12 x M8*50 Screws (#E) to tighten all the poles with the foot bases.
- Reinforcing the whole supporting frame with 4 x Pole #6. Please note that one end of the poles (#6) should be attached to the Pole Holder (attached to the #2 poles in Step 2) while the other end to the poles (#3). Fix both ends with 8 x M6*25 Screws (#F).

Please also remember to fix the structure to the ground by inserting the L-Shaped Pegs (#J) into the hole of foot bases.

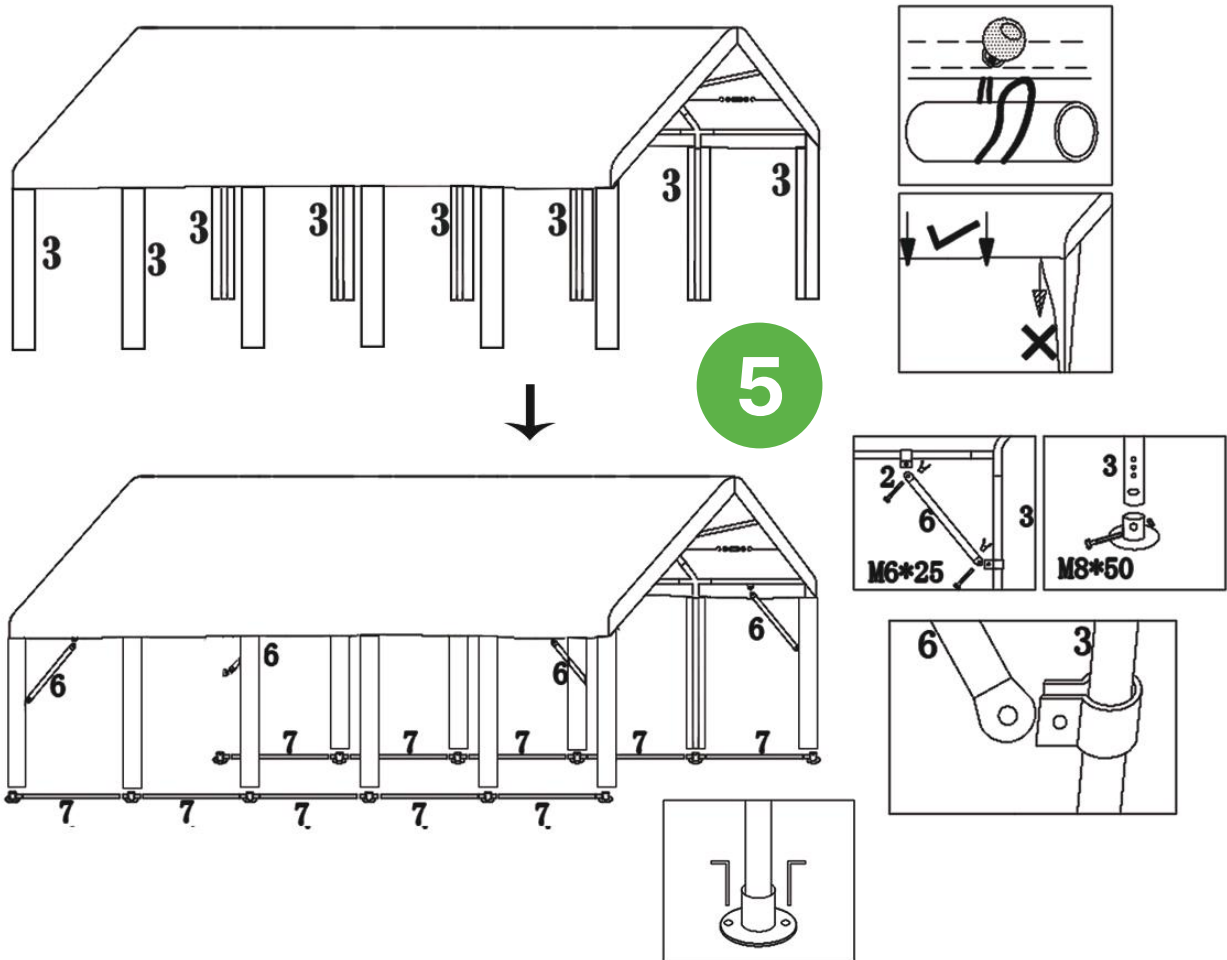

Step 6 Attach the 10 x Sidewalls with Window (#M) and the 2 x Zipper Doors (#N) as instructed below.

- Firstly, you need to fix all the sides and doors to the top frame with the Bungee Cords (#K).
- After fixing the window sides to the ground, please also fix them to the poles by wrapping up the built-in velcros.
- Finally, please fix the structure to the ground with the 12 x Guy Ropes (#I) and the 12 x L-Shaped Pegs (#J). To secure the tent better, it is recommended that you insert the L-Shaped Pegs **diagonally** into the ground. As shown, at a 45-degree to the ground is the best position.

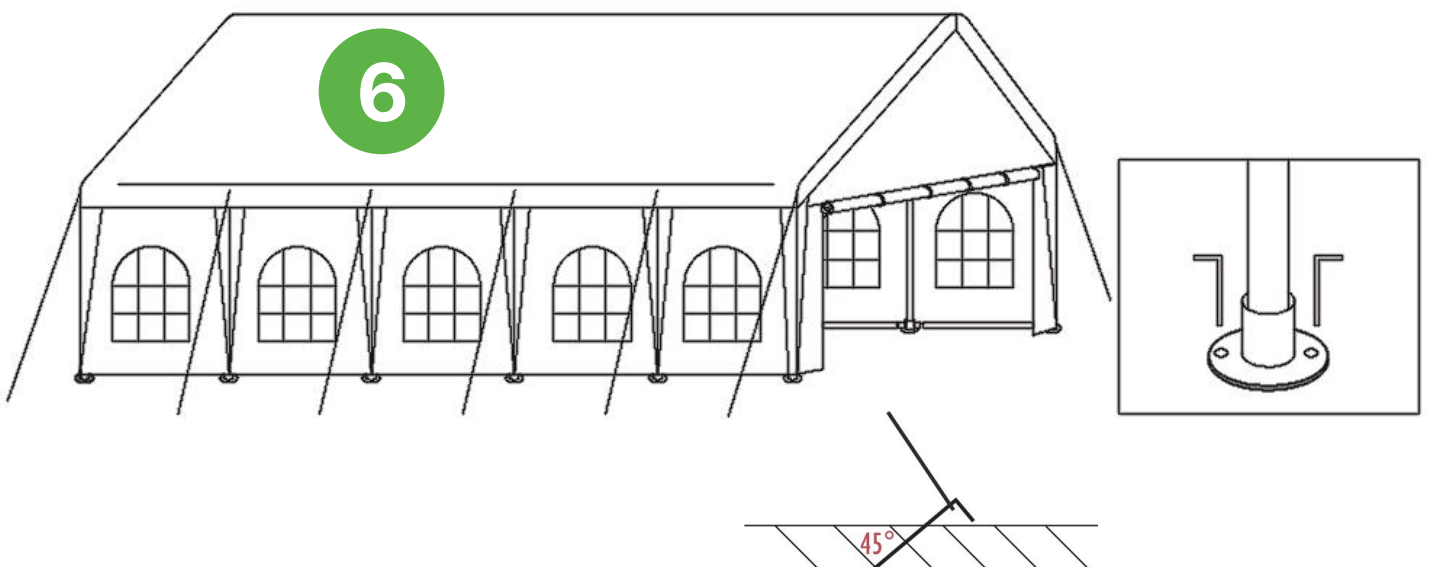

6m x 12m (Model #GM1413W)

Parts List

You'll receive eight (8) boxes for this model (**Model # GM1413W**). Please check to identify the packages by referring to **Table B** below. Pay particular attention to make sure all parts are numbered and graphically indexed as shown on the **Parts List (Table A)**, so does the quantity for each part. If you need any help, please contact us promptly (sales@quictents.com or 2maxlead.uk@gmail.com) with **the order number, required part(s), quantity for each part, and photos** (or video clips, if applicable), we will get back within 12 hours to help out.

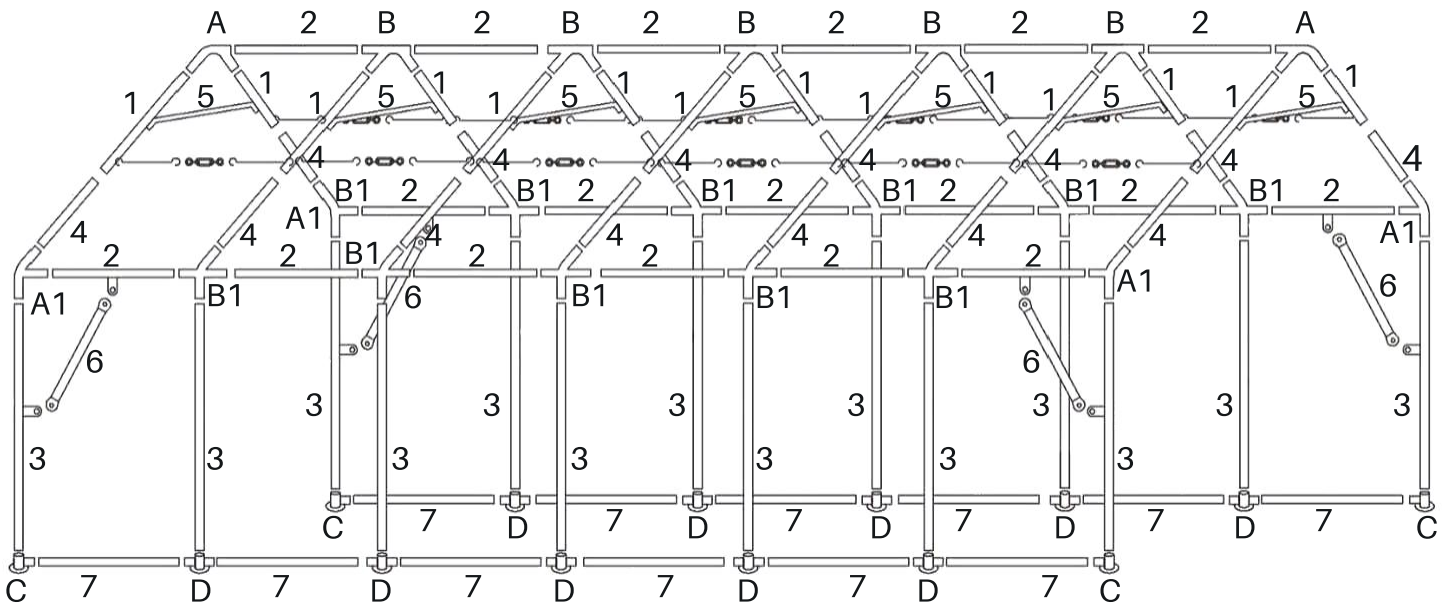

Table A. Parts List

Part Number	Diagram	Description	Quantity (PCS)
#1		Steel Pole (1.93m)	14
#2		Steel Pole (1.93m)	18
#3		Steel Pole (1.93m)	14
#4		Steel Pole (1.28m)	14
#5		Steel Pole (1.9m)	7
#6		Steel Pole (1.4m)	4
#7		Ground Bar (1.93m)	12
#A		3-Way Corner Connector	2











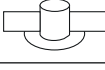
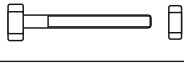
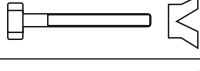
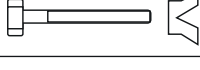

Part Number	Diagram	Description	Quantity (PCS)
#A1		3-Way Corner Connector	4
#B		4-Way Corner Connector	5
#B1		4-Way Corner Connector	10
#C		L-Shaped Foot Base (2-Corner)	4
#D		T-Shaped Foot Base (3-Corner)	10
#E		M8*50 Screw	14
#F		M6*25 Screw	8
#G		M6*70 Screw	14
#H1		Wire Rope	24
#H2		Cable Clip	12
#I		Guy Rope	14
#J		L-Shaped Peg	42
#K		Bungee Cord	172
#L		Roof Cover	1
#M		Sidewall with Window	12
#N		Zipper Door	2
#O		Pole Holder	8
#P		Carry Bag	5

Table B. Package Contents for Shipping Cartons

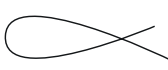
Part Number	Parts Included
Box #1	14 x Part#1 (Steel Pole) 24 x Part#H1(Wire Rope)
Box #2	14 x Part #3 (Steel Pole)
Box #3	14 x Part #4 (Steel Pole)
Box #4	18 x Part #2 (Steel Pole)
Box #5	7 x Part #5 (Steel Pole) 4 x Part #6 (Steel Pole) 12 x Part #7 (Steel Pole)
Box #6	12 x Part #H2(Cable Clip) All the Other Accessories not Mentioned in this Table
Box #7	1 x Part #L (Roof Cover)
Box #8	2 x Part #M (Zipper Door) 12 x Part #N (Sidewall with Window)

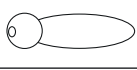
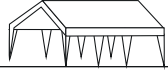
Assembly

Read Before the Assembly

Please check to make sure that you have all the parts listed on the **Parts Lists**.

Step 1 Form the top frame as per the layout instructed. You'll use poles of 14 x #1, 18 x #2, 14 x #4 and connectors of 2 x #A, 4 x #A1, 5 x Part #B, 10 x #B1 in this step.

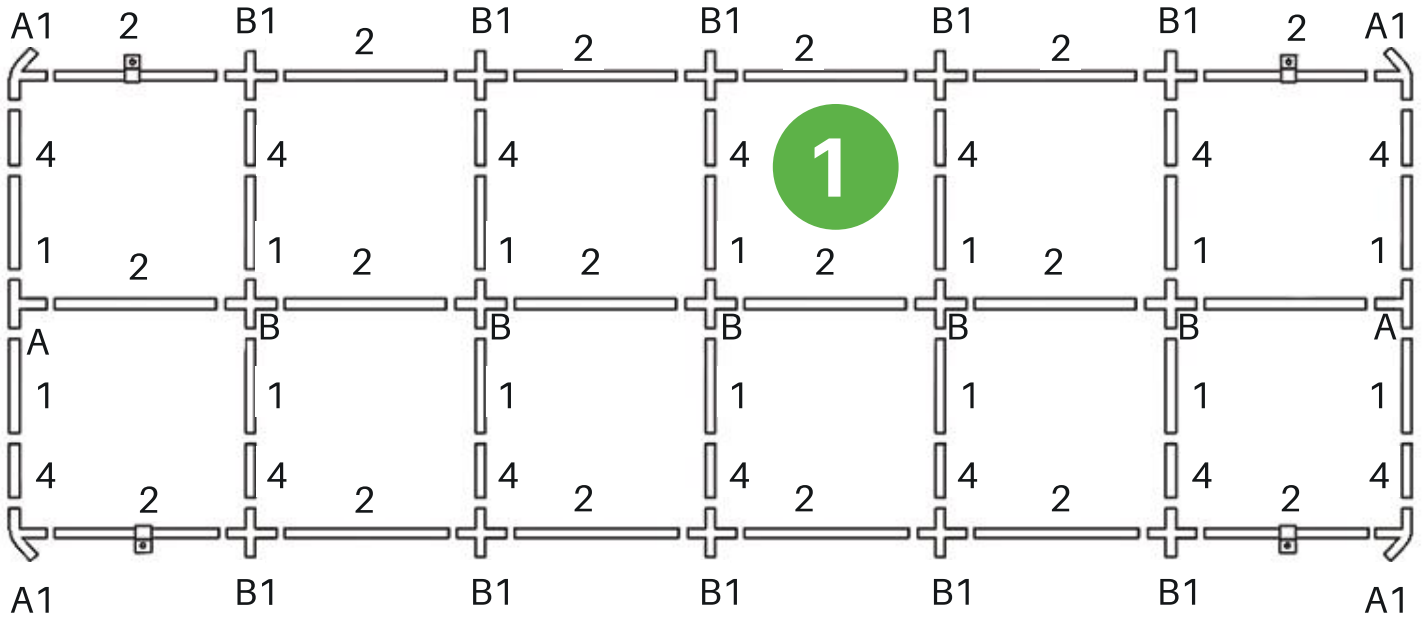

Step 2 Attach 4 x Pole Holder (#O) to the Pole (#2) accordingly and reinforce the top frame with the 7 x poles (#5) and the Steel Rope Sets (#H). You'll also use 14 x M6*70 Screw (#G) in this step.

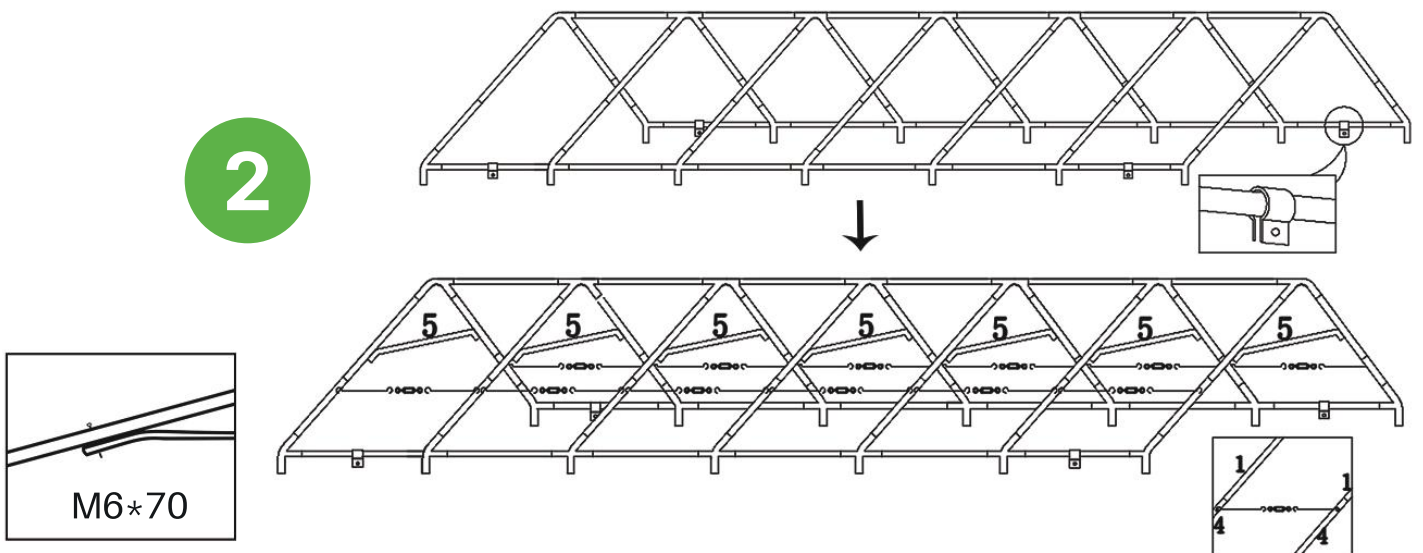

Step 3 Tighten the Roof Cover (#L) with the top frame with Bungee Cords (#K).

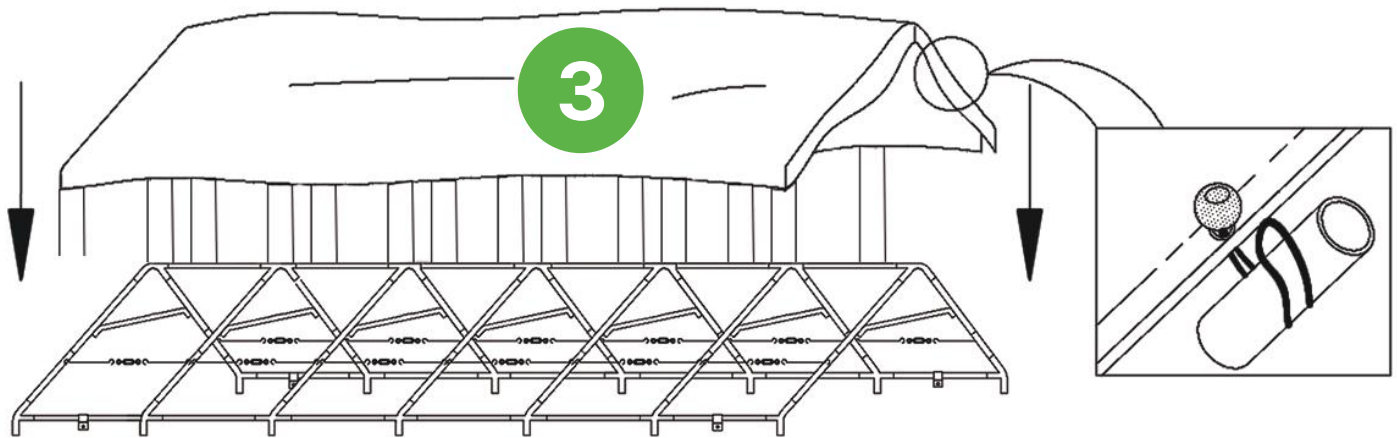

Step 4 Connect 7 x poles (#3) with the connectors (#A1 & #B1) on the top frame accordingly and lift the structure from the other side (**SEVERAL ADULTS REQUIRED!**).

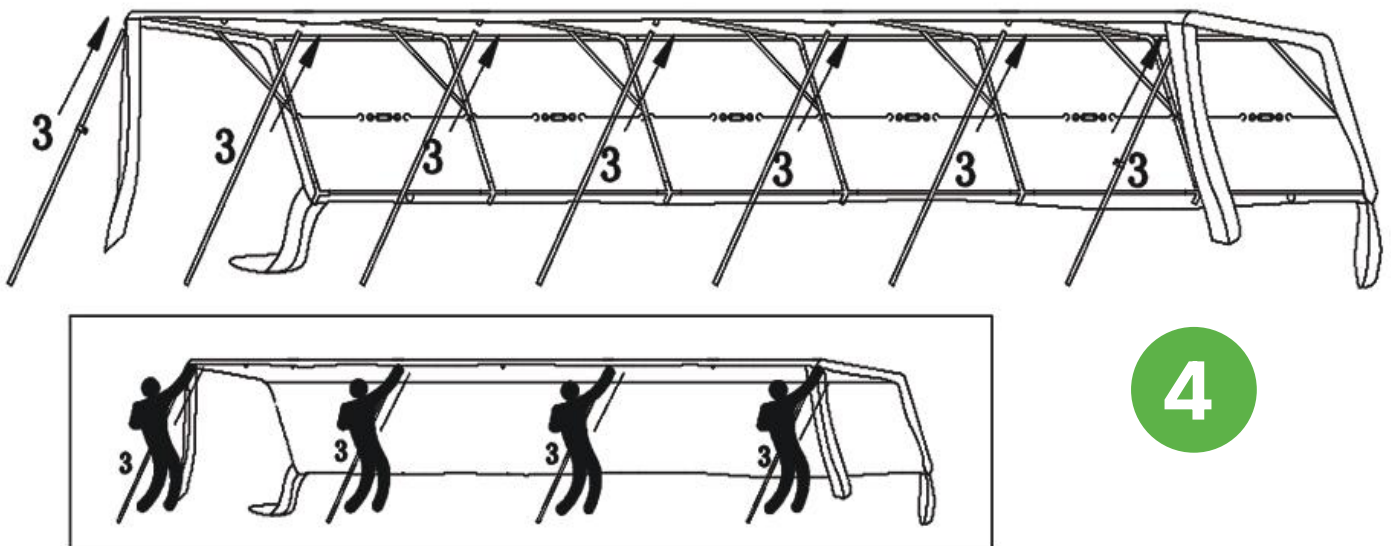

Step 5 Finish assembling the supporting frame by:

- Connecting the remaining 7 x #3 poles.
- Connecting the poles (#3) with the poles (#7) by using the 4 x L-Shaped Foot Bases (#C) and the 10 x T-Shaped Foot Bases (#D). You'll use 14 x M8x50 Screws (#E) to tighten all the poles with the foot bases.
- Reinforcing the whole supporting frame with 4 x Pole #6. Please note that one end of the poles (#6) should be attached to the Pole Holder (attached to the #2 poles in Step 2) while the other end to the poles (#3). Fix both ends with 8 x M6x25 Screws (#F).

IMPORTANT!

- You can tighten/loosen the leg covers by placing the hooks on the different adjusting holes (on the #3 poles).
- Please also remember to fix the structure to the ground by inserting the L-Shaped Pegs (#J) into the hole of foot bases.

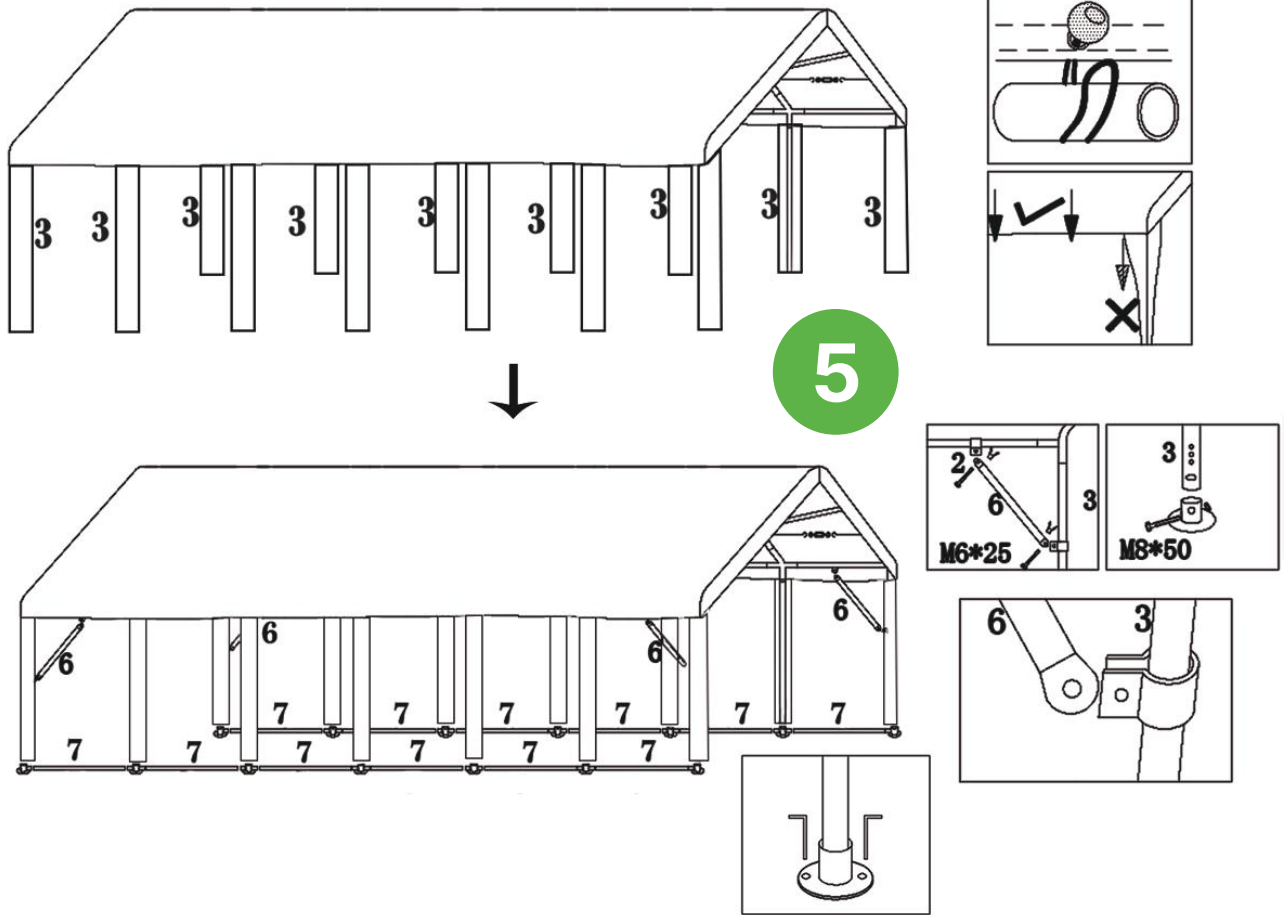

5

Step 6 Attach the 12 x Sidewalls with Window (#M) and the 2 x Zipper Doors (#N) as instructed below.

- a) Firstly, you need to fix all the sides and doors to the top frame with the Bungee Cords (#K).
- b) After fixing the window sides, please fix them to the poles by wrapping up the built-in velcros.
- c) Finally, please fix the structure to the ground with the 14 x Guy Ropes (#I) and the L-Shaped Peg (#J). To secure the tent better, it is recommended that you insert the L-Shaped Pegs **diagonally** into the ground. As shown, at a 45-degree to the ground is the best position.

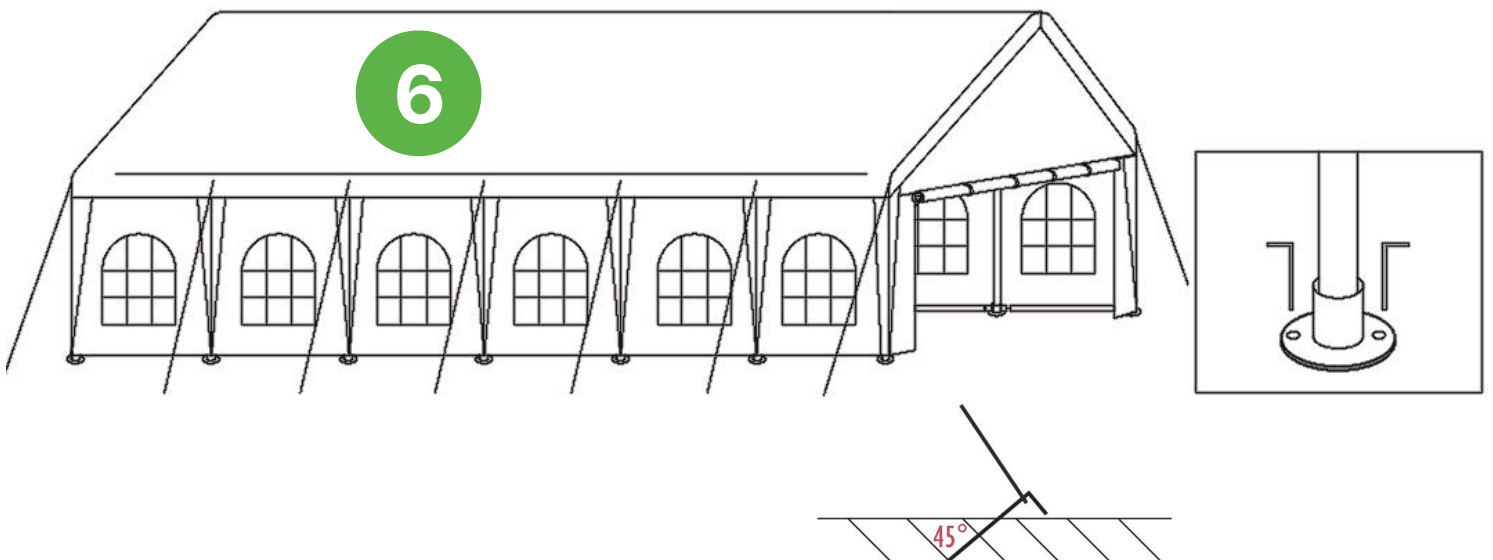

5m x 6.8m (Model #GM5501)

Parts List

You'll receive three (3) boxes for this model (**Model # GM5501**). Please check to identify the packages by referring to **Table B** below. Pay particular attention to make sure all parts are numbered and graphically indexed as shown on the **Parts List (Table A)**, so does the quantity for each part. If you need any help, please contact us promptly (sales@quictents.com or 2maxlead.uk@gmail.com) with **the order number, required part(s), quantity for each part, and photos** (or video clips, if applicable), we will get back within 12 hours to help out.

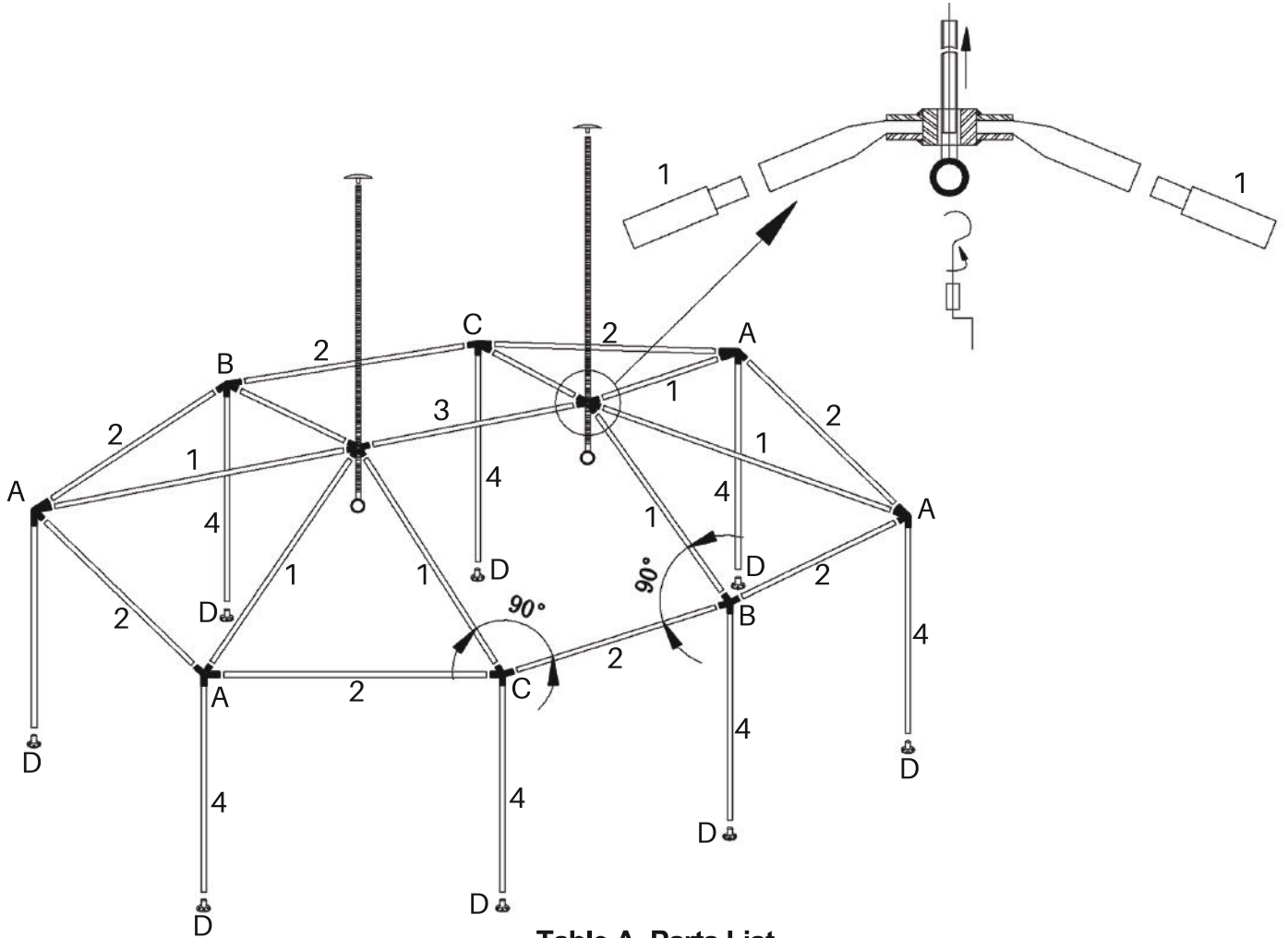

Table A. Parts List

Part Number	Diagram	Description	Quantity (PCS)
#1		Steel Pipe (2.42m)	8
#2		Steel Pipe (2.32m)	8
#3		Steel Pipe (2.26m)	1
#4		Steel Pipe with Adjusting Holes (1.95m)	8











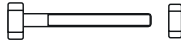

Part Number	Diagram	Description	Quantity (PCS)
#A		4-Way Corner Connector	4
#B		4-Way Corner Connector	2
#C		4-Way Corner Connector	2
#D		Foot Base	8
#E		L-Shaped Peg	24
#F		Bolt	8
#G		5-Way Corner Connector	2
#H1		Top Plate	2
#H2		Top Support Pole	2
#I		Roof Cover	1
#J		Sidewall with Window	6
#K		Zipper Door	2
#L		Erect Hook	1
#M		Guy Rope	8
#N		Bungee Cord	66

Table B. Package Contents for Shipping Cartons

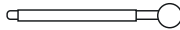
Part Number	Parts Included
Box #1	8 x Part #1 (Steel Pole) 8 x Part #2 (Steel Pole) 1 x Part #3 (Steel Pole) 1 x Part #L (Erect Hook) 2 x Part#H2(Top Support Pole)
Box #2	8 x Part #4 (Steel Pole)
Box #3	2 x Part #H1(Top Plate) 1 x Part #I (Roof Cover) 2 x Part #K (Zipper Door) 6 x Part #J (Sidewall with Window) All the Accessories not Mentioned in this Table

Step 3 Tighten the Roof Cover (#I) to the assembled top frame with the Bungee Cords (#N) and finish assembling the 8 x poles (#4) to the connectors (#A, #B, and #C) on the top frame. Please also remember to attach the 8 x Foot Bases (#D) to the bottom of the poles (#4).

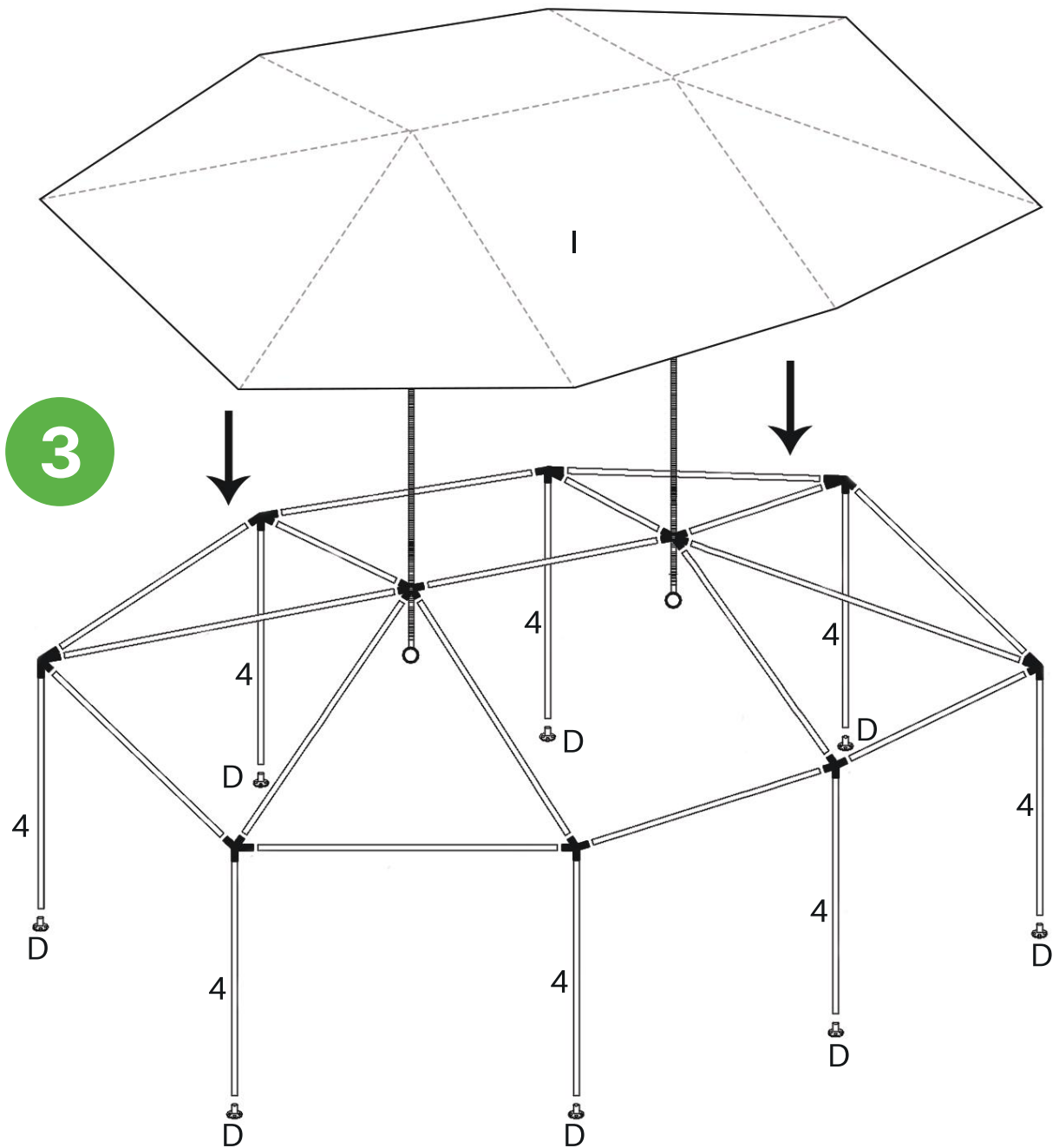

Step 4 Attach the 6 x Sidewalls with Window (#J) and the 2 x Zipper Doors (#K) as instructed below.

- a) Fix all the sides and doors to the top frame with the Bungee Cords (#E).
- b) Fix the sides to the poles by wrapping up the built-in velcros. You can tighten/loosen the leg cover (attached to the Roof Cover) by placing the hook into the different adjusting holes on the poles (#4).
- c) Fix the structure to the ground with the 8 x Guy Ropes (#M) and the 24 x L-Shaped Pegs (#E). To secure the tent better, it is recommended that you insert the L-Shaped Pegs diagonally into the ground. As shown, at a 45-degree to the ground is the best position.

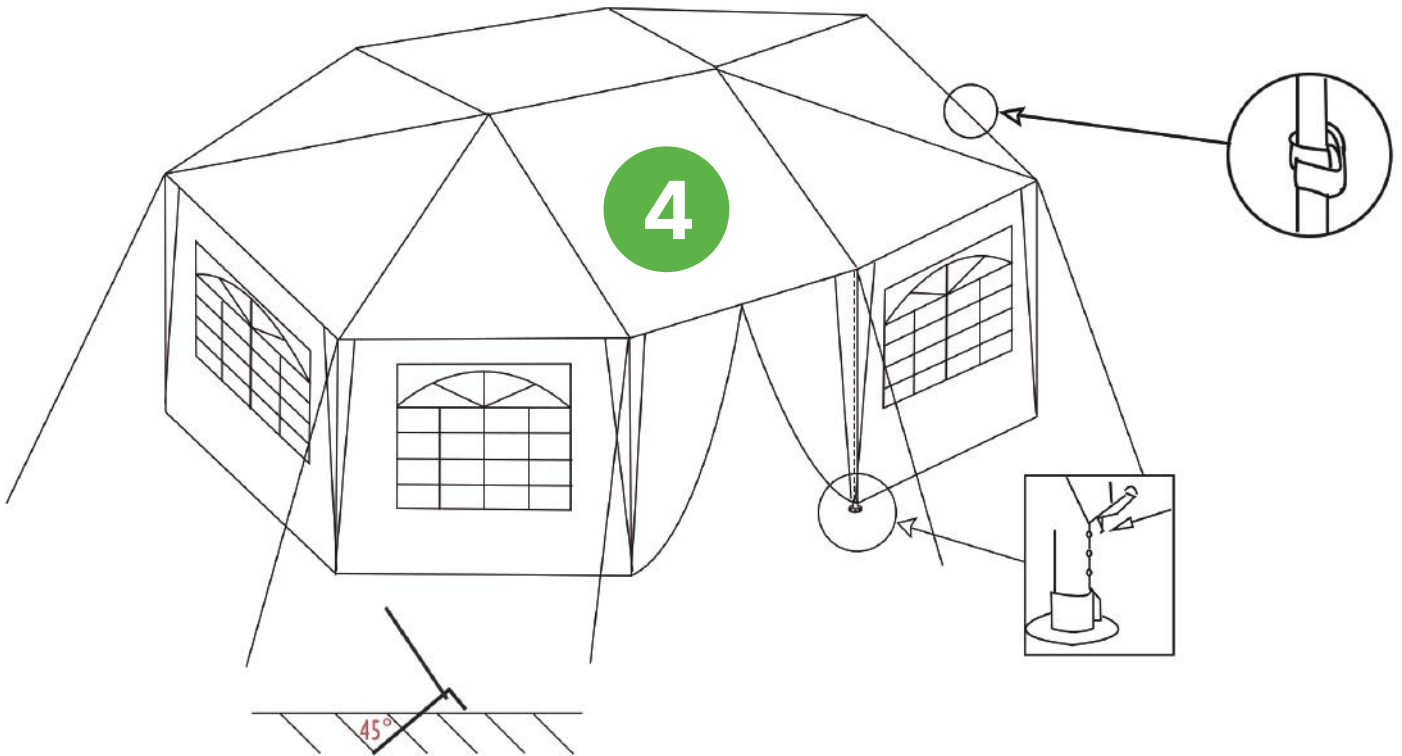

6.5m x 8.9m (Model #GM5502)

Parts List

You'll receive four (4) boxes for this model (**Model # GM5502**). Please check to identify the packages by referring to **Table B** below. Pay particular attention to make sure all parts are numbered and graphically indexed as shown on the **Parts List (Table A)**, so does the quantity for each part. If you need any help, please contact us promptly (sales@quictents.com or 2maxlead.uk@gmail.com) with **the order number, required part(s), quantity for each part, and photos** (or video clips, if applicable), we will get back within 12 hours to help out.

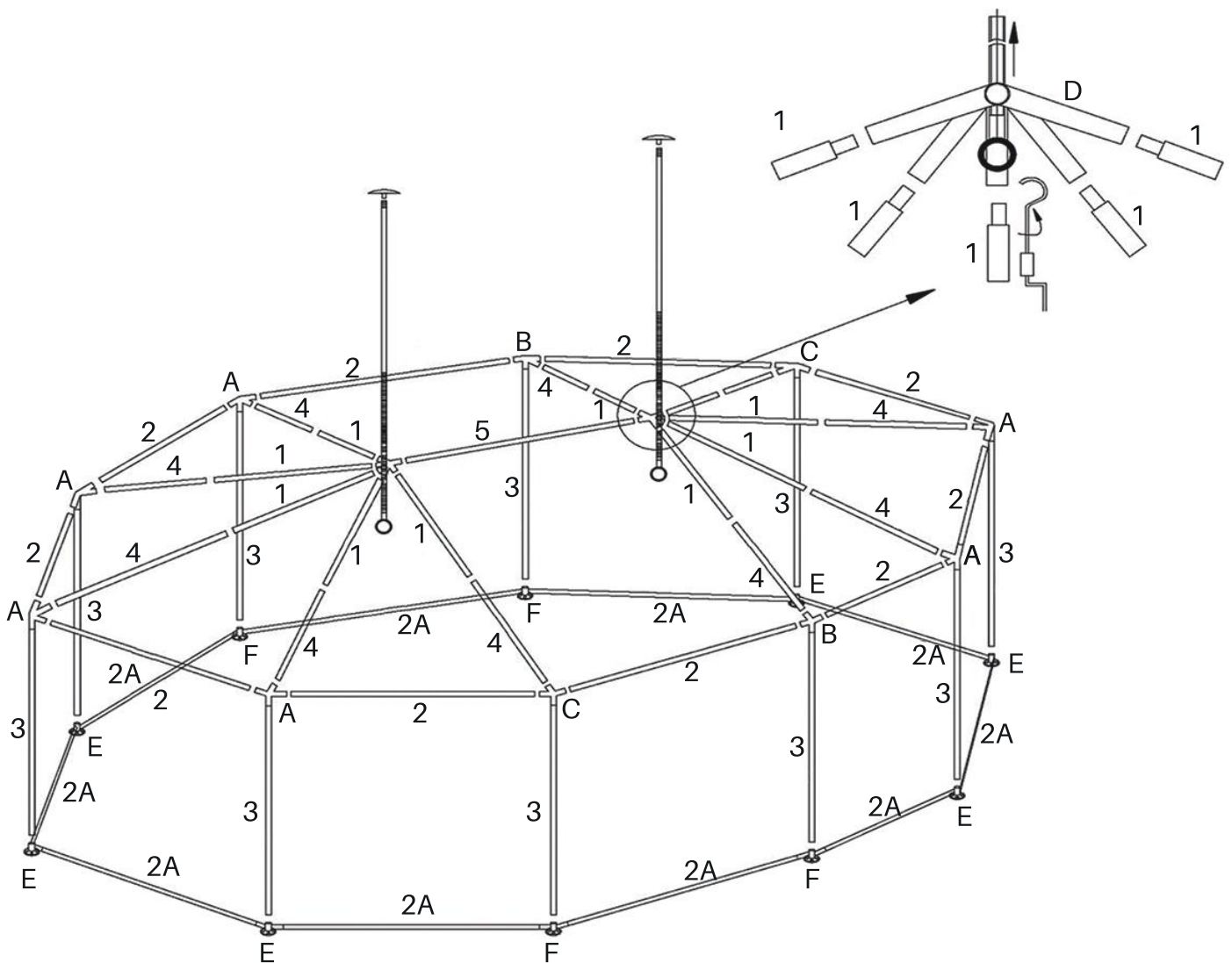

Table A. Parts List























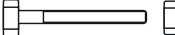

Part Number	Diagram	Description	Quantity (PCS)
#1		Steel Pipe (1.24m)	10
#2		Steel Pipe (2.26m)	10
#2A		Ground Bar (2.26m)	10
#3		Steel Pipe (1.95m)	10
#4		Steel Pipe (1.95m)	10
#5		Steel Pipe (2.26m)	1
#A		4-Way Corner Connector	6
#B		4-Way Corner Connector	2
#C		4-Way Corner Connector	2
#D		5-Way Corner Connector	2
#E		L-Shaped Foot Base (2-Corner)	6
#F		T-Shaped Foot Base (3-Corner)	4
#G		T-Shaped Foot Base (3-Corner)	40
#H		L-Shaped Peg	30
#I		Bolt	10
#J		Roof Cover	1
#K		Sidewall with Window	8
#L		Zipper Door	2
#M		Zipper Door	10
#N1		Top Plate	2
#N2		Top Support Pole	2
#O		Erect Hook	1
#P		Guy Rope	10
#Q		Bungee Cord	130

Table B. Package Contents for Shipping Cartons

Part Number	Parts Included
Box #1	10 x Part #1 (Steel Pole) 10 x Part #2 (Steel Pole) 1 x Part # O (Erect Hook) 2 x Part # L (Zipper Door) 2 x #N2 (Top Support Pole)
Box #2	10 x Pole #2A (Steel Pole) 1 x Pole #5 (Steel Pole) 8 x Part #K (Sidewalls with Window)
Box #3	10 x Part #3 (Steel Pole) 10 x Part #4 (Steel Pole)
Box #4	2 x #N1 (Top Plate) 1 x Part # J (Roof Cover) All the Accessories not Mentioned in this Table

Assembly

Read Before the Assembly

Please check to make sure that you have all the parts listed on the **Parts Lists**.

Step 1 Form the top frame as per the layout. The parts you'll use in this step are poles of 10 x #2 and connectors of 6 x #A, 2 x #B, and 2 x #C.

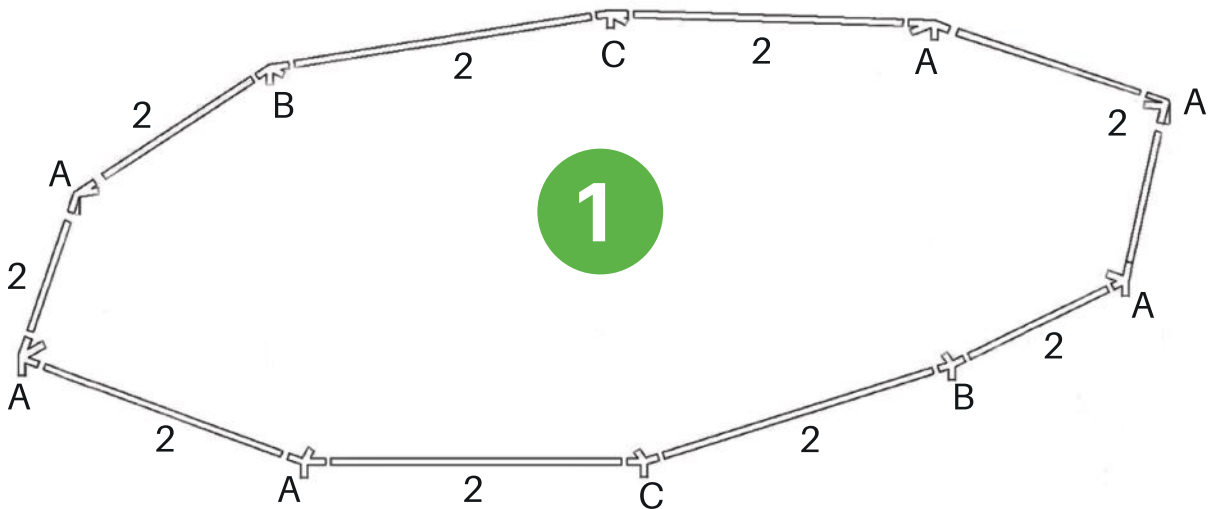

Step 2 Continue assembling the top frame by:

- Attaching one end of the poles (10 x #1 & 10 x #4) to the connectors (#A, #B, and #C).
- Attaching the other end of the poles (#1 & #4) to the connectors (2 x #D), then inserting the 2 x Top Thread Poles (#N) into the hole on the connectors (#D).

Reminder : You should set the 2 x Top Thread Poles (#H) at the lowest position at the beginning and adjust it to a proper height with the help of the Erect Hook (#O) after all work is done.

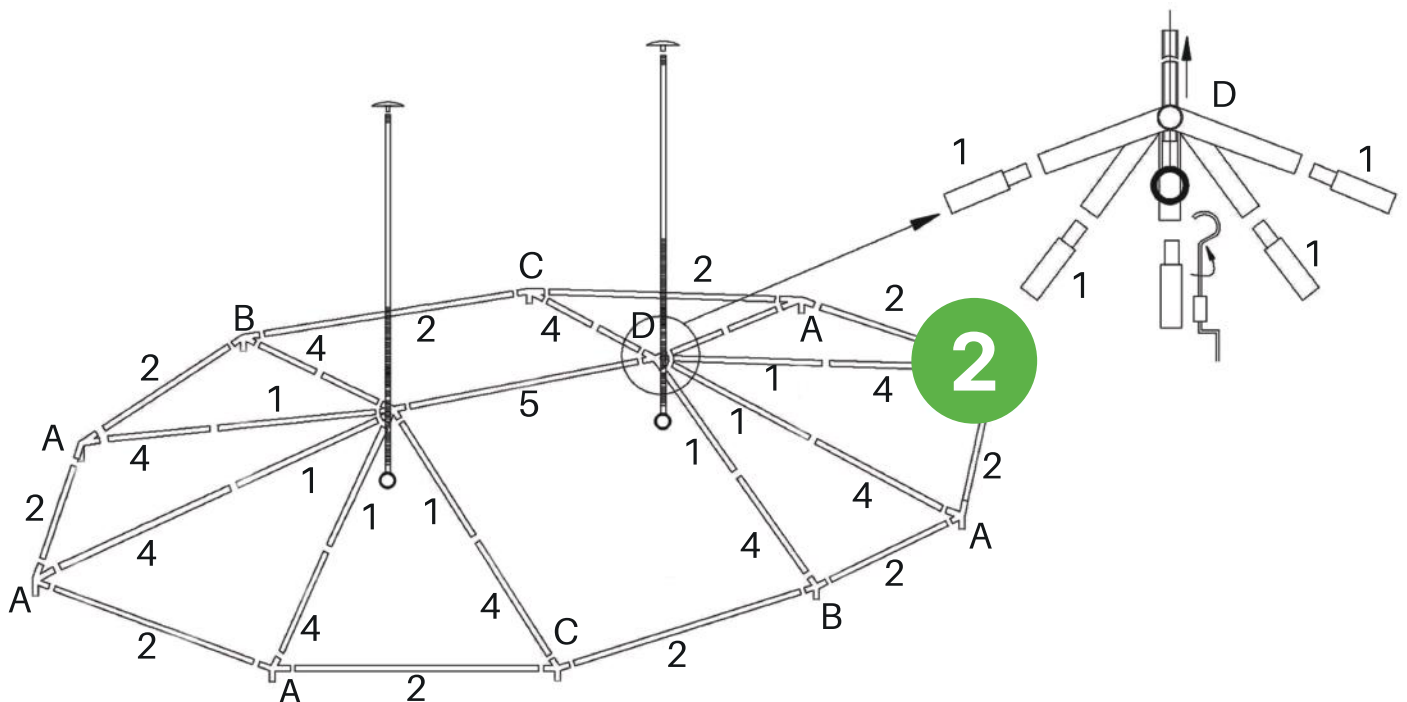

Step 3 You can finish assembling the Roof Cover (#J) and the supporting frame by:

- a) Tightening the Roof Cover (#J) to the assembled top frame with the Bungee Cords (#Q).
- b) Attaching one end of the 10 x poles (#3) to the connectors (#A, #B, and #C) on the top frame.
- c) Attaching the other end of the poles (#3) to the foot bases of 6 x #E and 4 x #F.
- d) Connecting the 10 x poles (#2A) to the foot bases (#E & #F) on the bottom.

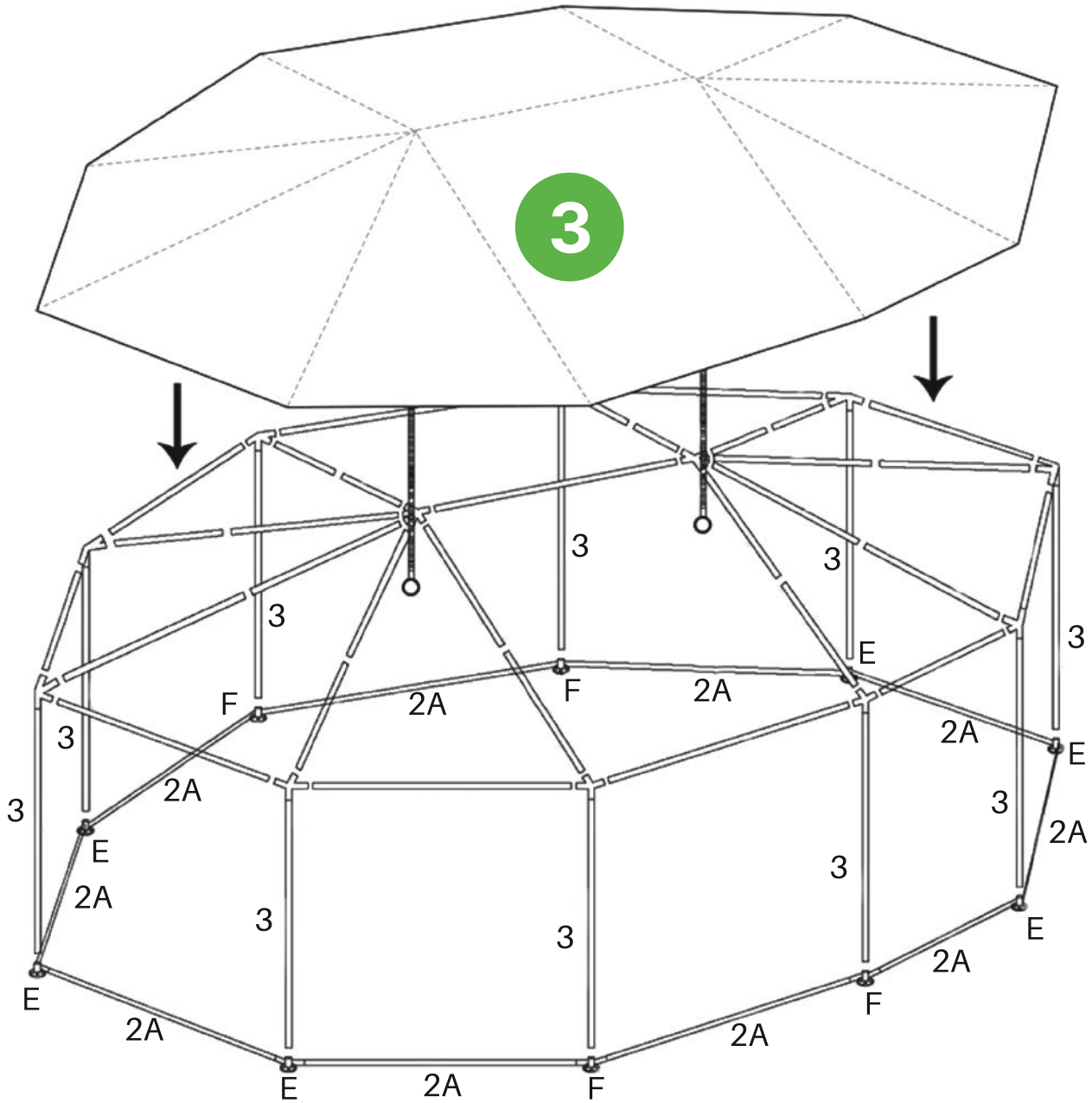

Step 4 Attach the 8 x Sidewalls with Window (#K) and the 2 x Zipper Doors (#K) as instructed below.

- a) Fix all the sides and doors to the top frame with the Bungee Cords (#Q) and by wrapping up the built-in velcros.
- b) Attaching one end of the 10 x poles (#3) to the connectors (#A, #B, and #C) on the top frame.
- c) Tighten/Loosen the 10 x Leg Covers (#M) by placing the hook into the different adjusting holes on the poles (#3).
- c) Fix the structure to the ground with the 10 x Guy Ropes (#M) and the 30 x L-Shaped Pegs (#E). To secure the tent better, it is recommended that you insert the L-Shaped Pegs **diagonally** into the ground. As shown, at a 45-degree to the ground is the best position.

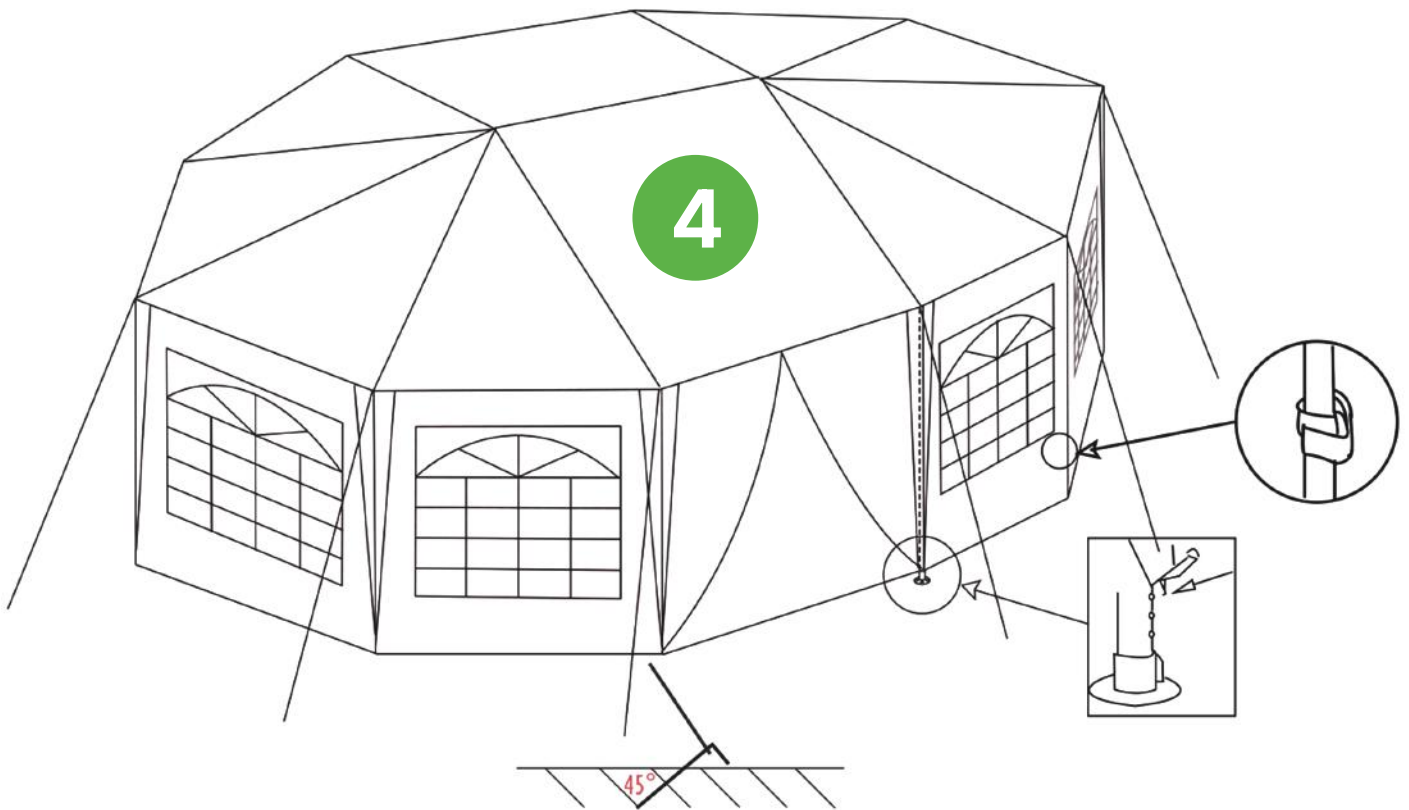

Maintenance

To help you maintain your party tent in optimal condition, please refer to our suggestions below:

- When in use, make sure to brush off dirt and debris and keep away from potentially damaging objects.
- Clean covers and sidewalls with water and mild detergent (or non-detergent, if applicable) only.
- To prevent your party tent from rust and mildew, please clean all disassembled parts and dry them completely before storing them.
- Store the disassembled party tent in a cool and dry place and keep away from animals.
- Inspect your tent carefully before and after each use. If any rips, tears, or damage is found, stop using it and email the support team (sales@quictents.com or 2maxlead.uk@gmail.com) with the **ORDER NUMBER, PART NUMBER, QUANTITY REQUIRED, and PHOTOS** (or video clips, if applicable), we will get back to you in 12 hours.

Warranty

The **12-month** limited warranty covering the materials and the craftsmanship under normal use and service conditions takes effect from the purchase date (on the invoice). Please note that the order purchase proof (order number or shipping information on the shipping carton) is the only valid evidence to claim for warranty.

Reminder

1. In the event that you failed to access your order information online, we strongly advise you to keep the original packaging and shipping carton(s) because they are treated as a proof of purchase.
2. To get what you need as soon as possible, we strongly suggest you provide all of the following information **at your first inquiry**:
 - Order number
 - Part number
 - Quantity required for each part
 - Pictures (or video clips, if applicable)

Warning

- Restructuring the product without written permission from Quictent in advance would **VOID** the warranty.
- Damages due to improper use in severe weather conditions, including but not limited to high winds, heavy rain, sleet, snow, etc., will NOT be covered by the warranty.



Quictent

SHELTERS FOR MOST PEOPLE



QT-UK-TENT-202101